

# IRG4BC30UDPbF

INSULATED GATE BIPOLAR TRANSISTOR WITH  
 ULTRAFast SOFT RECOVERY DIODE

UltraFast CoPack IGBT

## Features

- UltraFast: Optimized for high operating frequencies 8-40 kHz in hard switching, >200 kHz in resonant mode
- Generation 4 IGBT design provides tighter parameter distribution and higher efficiency than Generation 3
- IGBT co-packaged with HEXFRED™ ultrafast, ultra-soft-recovery anti-parallel diodes for use in bridge configurations
- Industry standard TO-220AB package
- Lead-Free

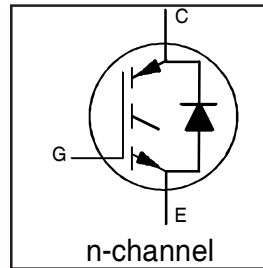

$V_{CES} = 600V$
$V_{CE(on) typ.} = 1.95V$
@ $V_{GE} = 15V, I_C = 12A$

## Benefits

- Generation -4 IGBT's offer highest efficiencies available
- IGBTs optimized for specific application conditions
- HEXFRED diodes optimized for performance with IGBTs . Minimized recovery characteristics require less/no snubbing
- Designed to be a "drop-in" replacement for equivalent industry-standard Generation 3 IR IGBTs

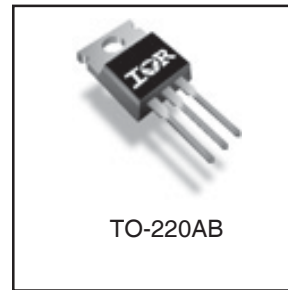

## Absolute Maximum Ratings

	Parameter	Max.	Units
$V_{CES}$	Collector-to-Emitter Voltage	600	V
$I_C @ T_C = 25^\circ C$	Continuous Collector Current	23	A
$I_C @ T_C = 100^\circ C$	Continuous Collector Current	12	
$I_{CM}$	Pulsed Collector Current ①	92	
$I_{LM}$	Clamped Inductive Load Current ②	92	
$I_F @ T_C = 100^\circ C$	Diode Continuous Forward Current	12	
$I_{FM}$	Diode Maximum Forward Current	92	
$V_{GE}$	Gate-to-Emitter Voltage	$\pm 20$	V
$P_D @ T_C = 25^\circ C$	Maximum Power Dissipation	100	W
$P_D @ T_C = 100^\circ C$	Maximum Power Dissipation	42	
$T_J$	Operating Junction and Storage Temperature Range	-55 to +150	°C
$T_{STG}$			
	Mounting Torque, 6-32 or M3 Screw.	10 lbf•in (1.1 N•m)	

## Thermal Resistance

	Parameter	Min.	Typ.	Max.	Units
$R_{\theta JC}$	Junction-to-Case - IGBT	-----	-----	1.2	°C/W
$R_{\theta JC}$	Junction-to-Case - Diode	-----	-----	2.5	
$R_{\theta CS}$	Case-to-Sink, flat, greased surface	-----	0.50	-----	
$R_{\theta JA}$	Junction-to-Ambient, typical socket mount	-----	-----	80	
Wt	Weight	-----	2 (0.07)	-----	

## Electrical Characteristics @ T<sub>J</sub> = 25°C (unless otherwise specified)

	Parameter	Min.	Typ.	Max.	Units	Conditions
V <sub>(BR)CES</sub>	Collector-to-Emitter Breakdown Voltage <sup>③</sup>	600	----	----	V	V <sub>GE</sub> = 0V, I <sub>C</sub> = 250μA
ΔV <sub>(BR)CES</sub> /ΔT <sub>J</sub>	Temperature Coeff. of Breakdown Voltage	----	0.63	----	V/°C	V <sub>GE</sub> = 0V, I <sub>C</sub> = 1.0mA
V <sub>CE(on)</sub>	Collector-to-Emitter Saturation Voltage	----	1.95	2.1	V	I <sub>C</sub> = 12A
		----	2.52	----		I <sub>C</sub> = 23A
		----	2.09	----		I <sub>C</sub> = 12A, T <sub>J</sub> = 150°C
V <sub>GE(th)</sub>	Gate Threshold Voltage	3.0	----	6.0		V <sub>CE</sub> = V <sub>GE</sub> , I <sub>C</sub> = 250μA
ΔV <sub>GE(th)</sub> /ΔT <sub>J</sub>	Temperature Coeff. of Threshold Voltage	----	-11	----	mV/°C	V <sub>CE</sub> = V <sub>GE</sub> , I <sub>C</sub> = 250μA
g <sub>fe</sub>	Forward Transconductance <sup>④</sup>	3.1	8.6	----	S	V <sub>CE</sub> = 100V, I <sub>C</sub> = 12A
I <sub>CES</sub>	Zero Gate Voltage Collector Current	----	----	250	μA	V <sub>GE</sub> = 0V, V <sub>CE</sub> = 600V
		----	----	2500		V <sub>GE</sub> = 0V, V <sub>CE</sub> = 600V, T <sub>J</sub> = 150°C
V <sub>FM</sub>	Diode Forward Voltage Drop	----	1.4	1.7	V	I <sub>C</sub> = 12A
		----	1.3	1.6		I <sub>C</sub> = 12A, T <sub>J</sub> = 150°C
I <sub>GES</sub>	Gate-to-Emitter Leakage Current	----	----	±100	nA	V <sub>GE</sub> = ±20V

## Switching Characteristics @ T<sub>J</sub> = 25°C (unless otherwise specified)

	Parameter	Min.	Typ.	Max.	Units	Conditions	
Q <sub>g</sub>	Total Gate Charge (turn-on)	----	50	75		I <sub>C</sub> = 12A	
Q <sub>ge</sub>	Gate - Emitter Charge (turn-on)	----	8.1	12	nC	V <sub>CC</sub> = 400V	
Q <sub>gc</sub>	Gate - Collector Charge (turn-on)	----	18	27		V <sub>GE</sub> = 15V	
t <sub>d(on)</sub>	Turn-On Delay Time	----	40	----		T <sub>J</sub> = 25°C	
t <sub>r</sub>	Rise Time	----	21	----	ns	I <sub>C</sub> = 12A, V <sub>CC</sub> = 480V	
t <sub>d(off)</sub>	Turn-Off Delay Time	----	91	140		V <sub>GE</sub> = 15V, R <sub>G</sub> = 23Ω	
t <sub>f</sub>	Fall Time	----	80	130		Energy losses include "tail" and diode reverse recovery.	
E <sub>on</sub>	Turn-On Switching Loss	----	0.38	----		mJ	See Fig. 9, 10, 11, 18
E <sub>off</sub>	Turn-Off Switching Loss	----	0.16	----			
E <sub>ts</sub>	Total Switching Loss	----	0.54	0.9		mJ	T <sub>J</sub> = 150°C, See Fig. 9, 10, 11, 18
t <sub>d(on)</sub>	Turn-On Delay Time	----	40	----			
t <sub>r</sub>	Rise Time	----	22	----		ns	I <sub>C</sub> = 12A, V <sub>CC</sub> = 480V
t <sub>d(off)</sub>	Turn-Off Delay Time	----	120	----			V <sub>GE</sub> = 15V, R <sub>G</sub> = 23Ω
t <sub>f</sub>	Fall Time	----	180	----			Energy losses include "tail" and diode reverse recovery.
E <sub>ts</sub>	Total Switching Loss	----	0.89	----	Measured 5mm from package		
L <sub>E</sub>	Internal Emitter Inductance	----	7.5	----	nH		
C <sub>ies</sub>	Input Capacitance	----	1100	----	pF	V <sub>GE</sub> = 0V	
C <sub>oes</sub>	Output Capacitance	----	73	----		V <sub>CC</sub> = 30V	
C <sub>res</sub>	Reverse Transfer Capacitance	----	14	----		f = 1.0MHz	
t <sub>rr</sub>	Diode Reverse Recovery Time	----	42	60	ns	T <sub>J</sub> = 25°C See Fig.	
I <sub>rr</sub>	Diode Peak Reverse Recovery Current	----	80	120		T <sub>J</sub> = 125°C 14	
Q <sub>rr</sub>	Diode Reverse Recovery Charge	----	3.5	6.0	A	T <sub>J</sub> = 25°C See Fig.	
		----	5.6	10		T <sub>J</sub> = 125°C 15	
di <sub>(rec)</sub> M/dt	Diode Peak Rate of Fall of Recovery During t <sub>b</sub>	----	80	180	nC	T <sub>J</sub> = 25°C See Fig.	
		----	220	600		T <sub>J</sub> = 125°C 16	
		----	180	----	A/μs	T <sub>J</sub> = 25°C See Fig.	
		----	120	----		T <sub>J</sub> = 125°C 17	

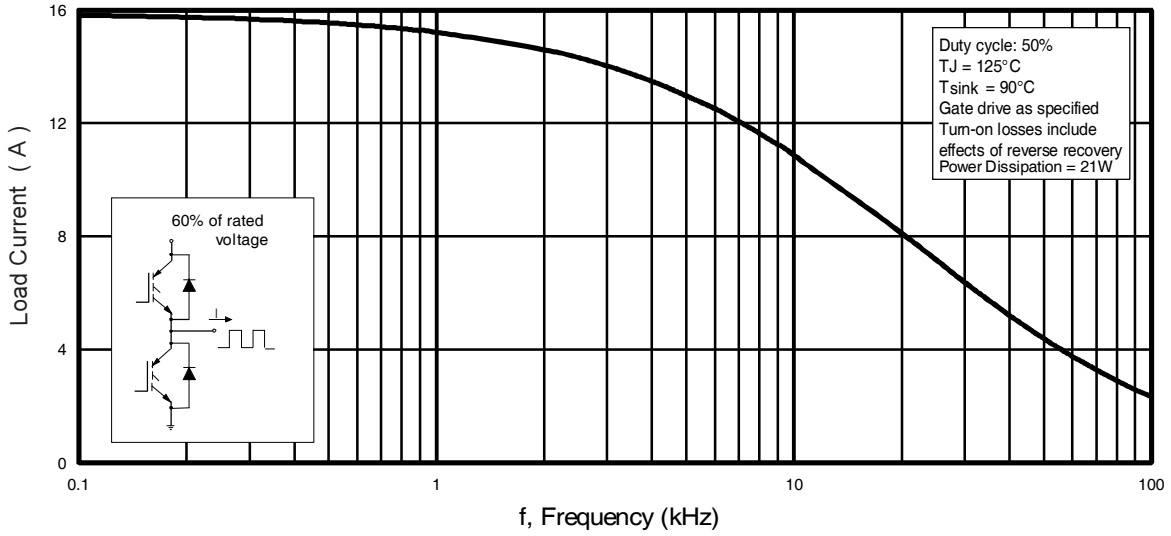

**Fig. 1 - Typical Load Current vs. Frequency**  
(Load Current =  $I_{RMS}$  of fundamental)

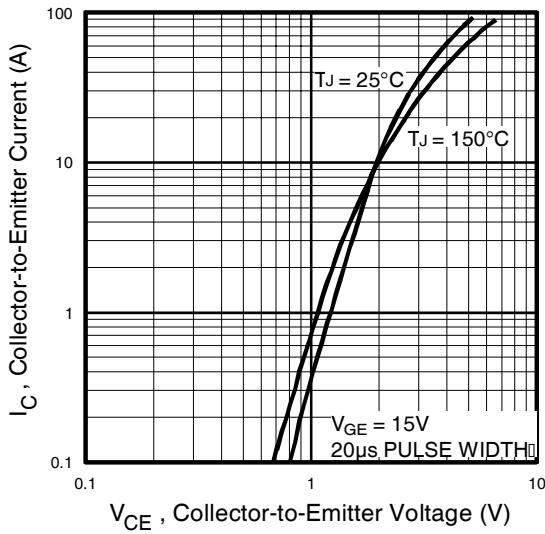

**Fig. 2 - Typical Output Characteristics**

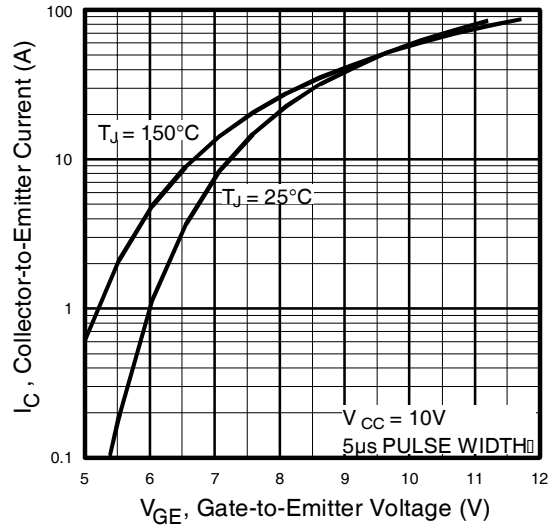

**Fig. 3 - Typical Transfer Characteristics**

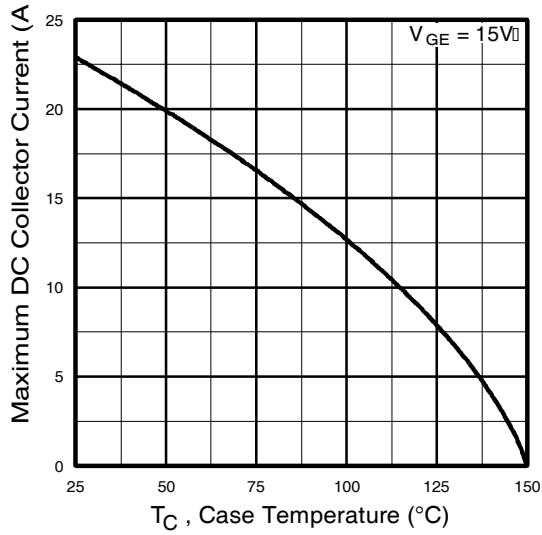

**Fig. 4 - Maximum Collector Current vs. Case Temperature**

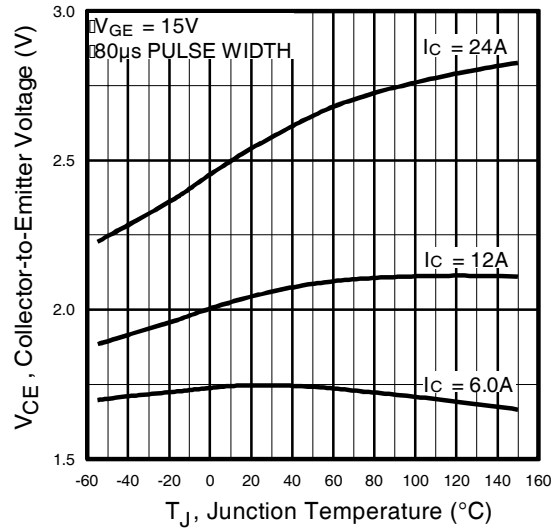

**Fig. 5 - Typical Collector-to-Emitter Voltage vs. Junction Temperature**

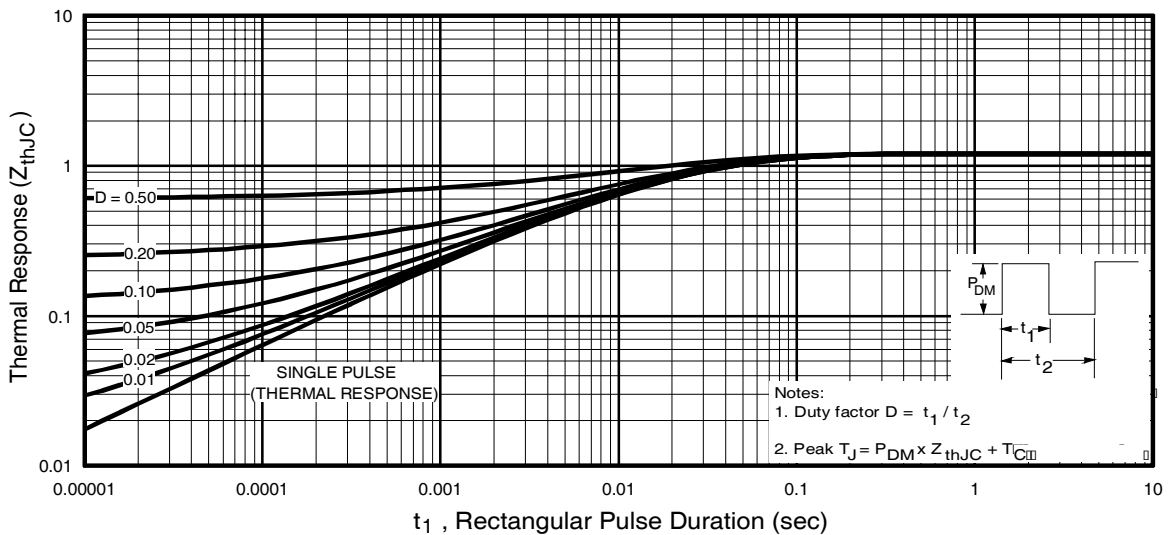

**Fig. 6 - Maximum IGBT Effective Transient Thermal Impedance, Junction-to-Case**

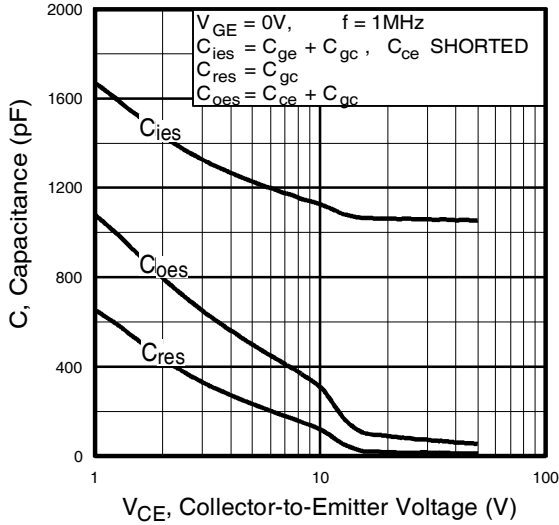

**Fig. 7** - Typical Capacitance vs. Collector-to-Emitter Voltage

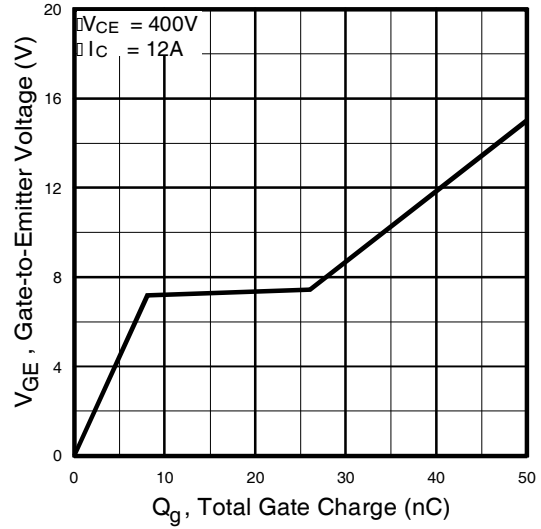

**Fig. 8** - Typical Gate Charge vs. Gate-to-Emitter Voltage

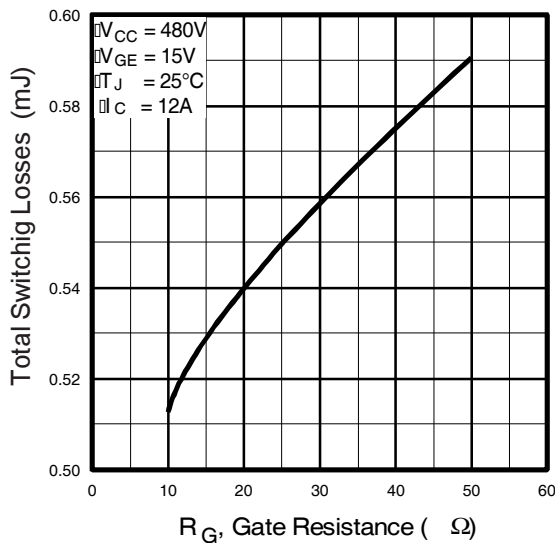

**Fig. 9** - Typical Switching Losses vs. Gate Resistance

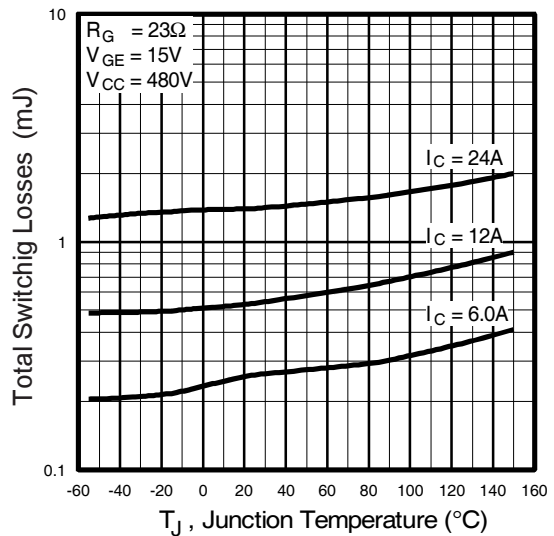

**Fig. 10** - Typical Switching Losses vs. Junction Temperature

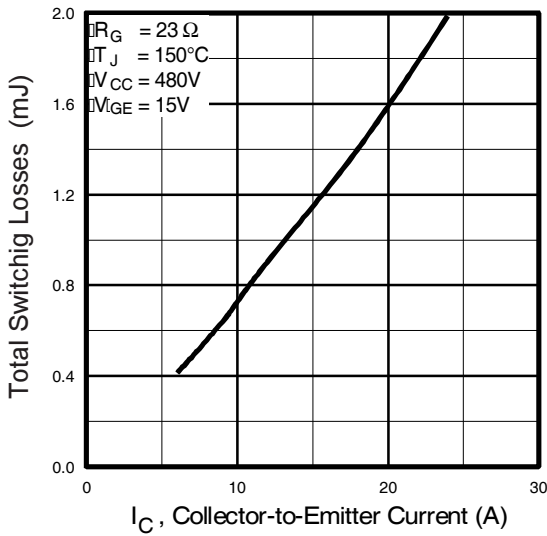

**Fig. 11** - Typical Switching Losses vs. Collector-to-Emitter Current

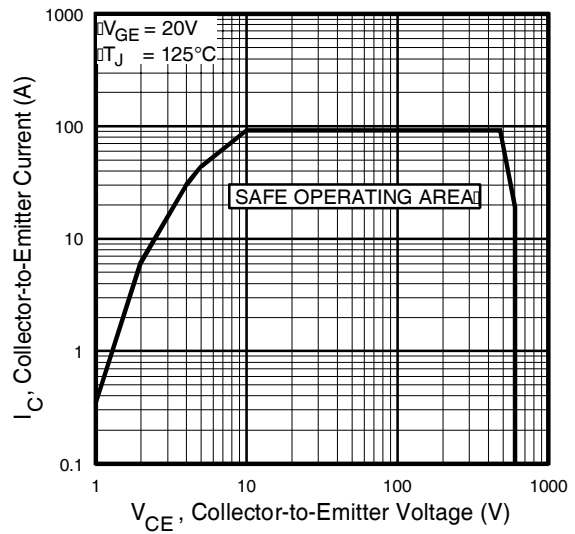

**Fig. 12** - Turn-Off SOA

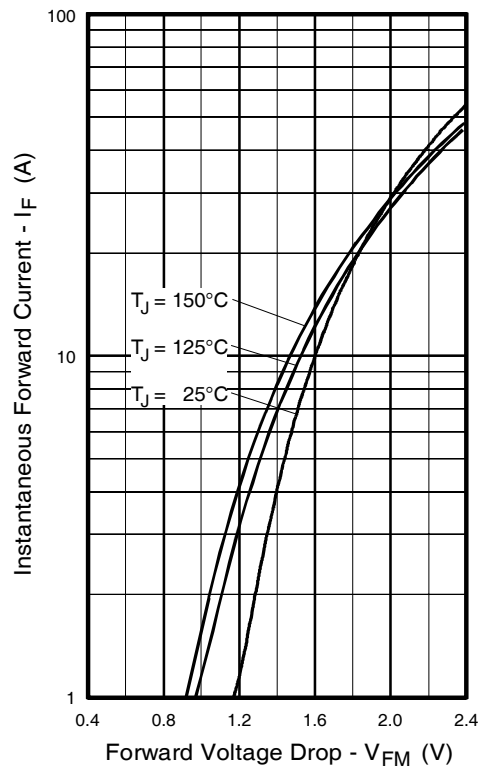

**Fig. 13** - Maximum Forward Voltage Drop vs. Instantaneous Forward Current

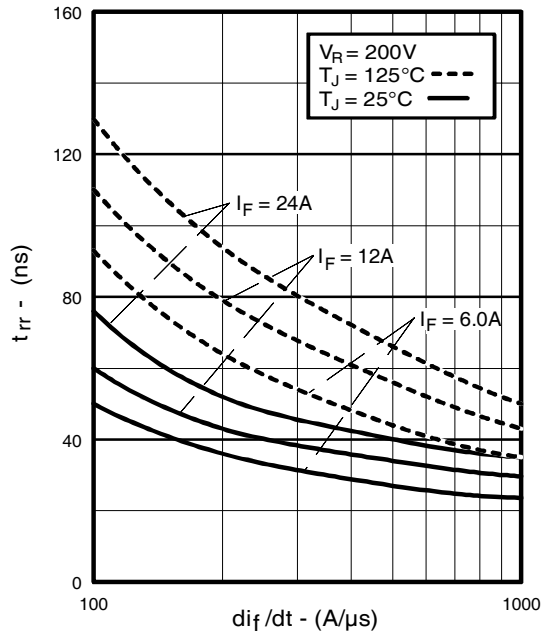

**Fig. 14** - Typical Reverse Recovery vs.  $di_f/dt$

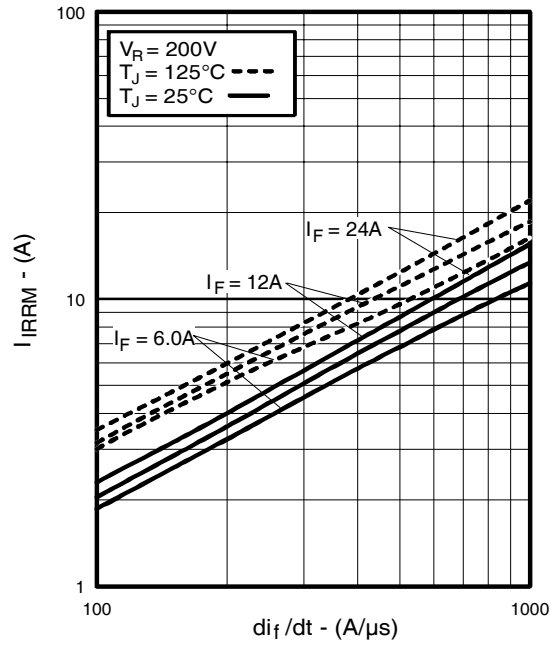

**Fig. 15** - Typical Recovery Current vs.  $di_f/dt$

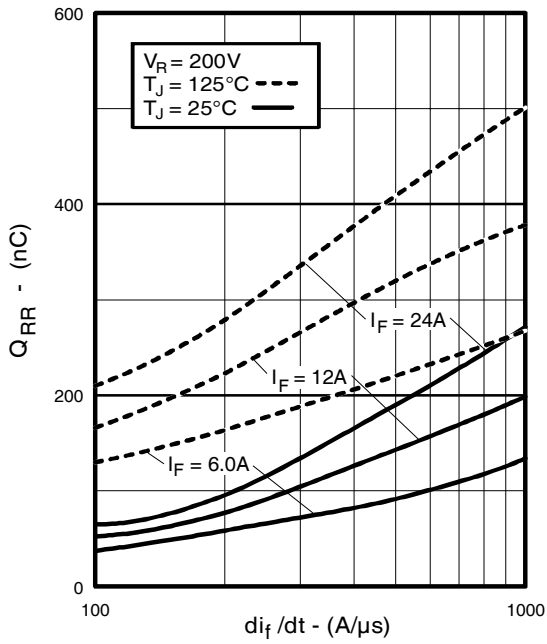

**Fig. 16** - Typical Stored Charge vs.  $di_f/dt$

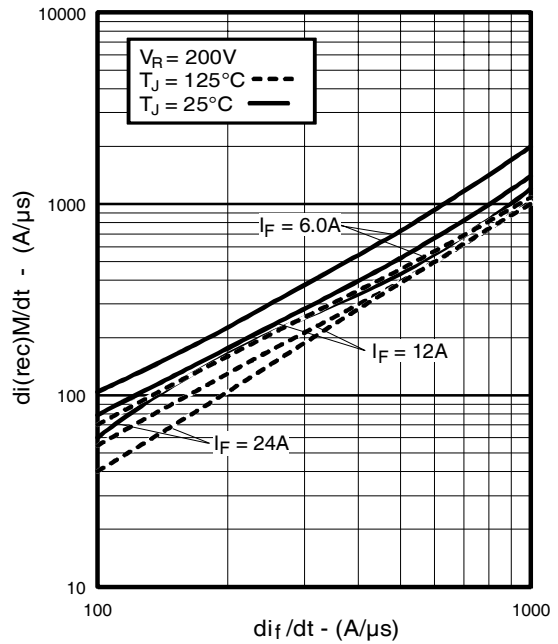

**Fig. 17** - Typical  $di_{(rec)M}/dt$  vs.  $di_f/dt$

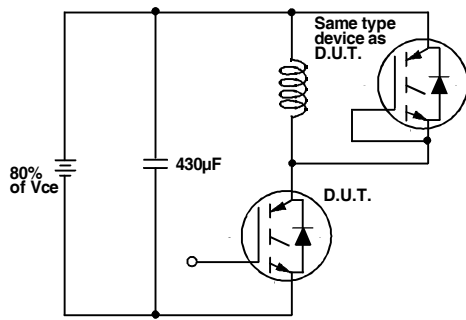

**Fig. 18a** - Test Circuit for Measurement of  $I_{LM}$ ,  $E_{on}$ ,  $E_{off}(\text{diode})$ ,  $t_{rr}$ ,  $Q_{rr}$ ,  $I_{rr}$ ,  $t_{d(on)}$ ,  $t_r$ ,  $t_{d(off)}$ ,  $t_f$

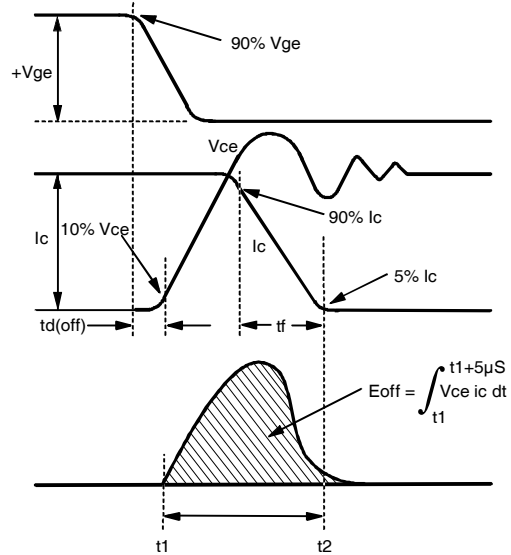

**Fig. 18b** - Test Waveforms for Circuit of Fig. 18a, Defining  $E_{off}$ ,  $t_{d(off)}$ ,  $t_f$

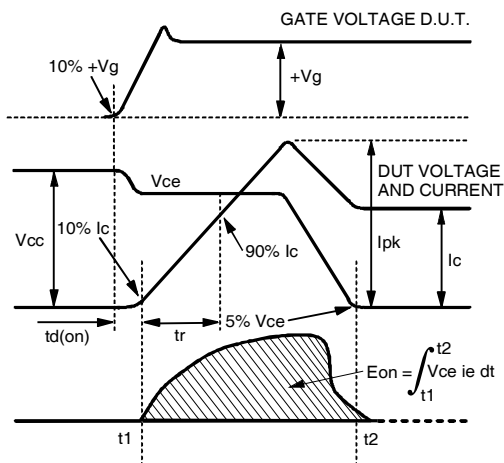

**Fig. 18c** - Test Waveforms for Circuit of Fig. 18a, Defining  $E_{on}$ ,  $t_{d(on)}$ ,  $t_r$

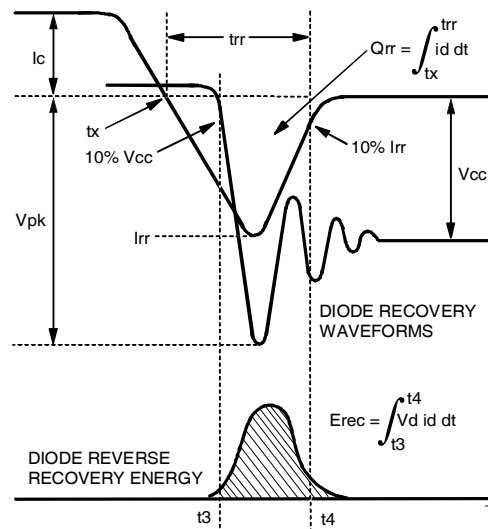

**Fig. 18d** - Test Waveforms for Circuit of Fig. 18a, Defining  $E_{rec}$ ,  $t_{rr}$ ,  $Q_{rr}$ ,  $I_{rr}$



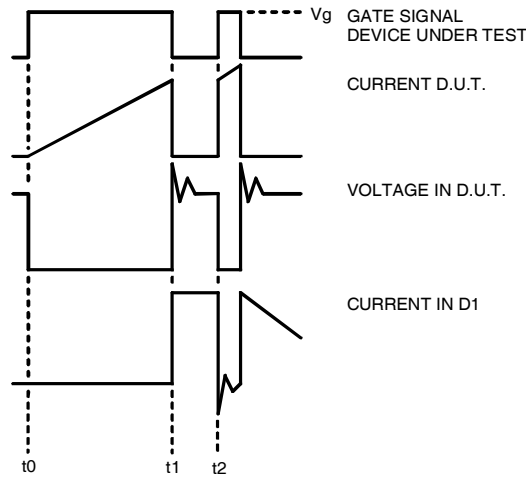

Figure 18e. Macro Waveforms for Figure 18a's Test Circuit

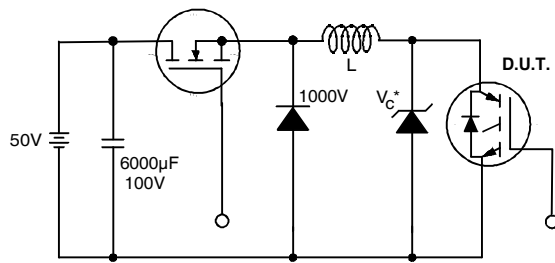
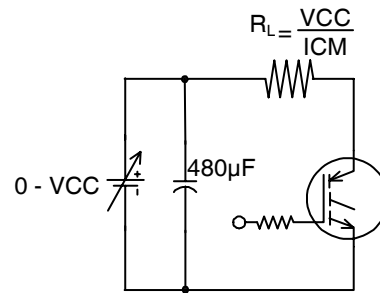

Figure 19. Clamped Inductive Load Test Circuit



Pulsed Collector Current Test Circuit  
 Figure 20. Pulsed Collector Current Test Circuit

# IRG4BC30UDPbF

International  
**IR** Rectifier

## Notes:

- ① Repetitive rating:  $V_{GE}=20V$ ; pulse width limited by maximum junction temperature (figure 20)
- ②  $V_{CC}=80\%(V_{CES})$ ,  $V_{GE}=20V$ ,  $L=10\mu H$ ,  $R_G = 23\Omega$  (figure 19)
- ③ Pulse width  $\leq 80\mu s$ ; duty factor  $\leq 0.1\%$ .
- ④ Pulse width  $5.0\mu s$ , single shot.

## TO-220AB Package Outline (Dimensions are shown in millimeters (inches))

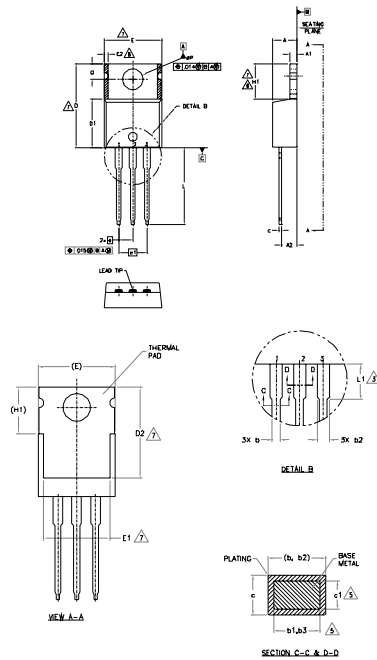

- NOTES:
- 1- DIMENSIONING AND TOLERANCING AS PER ASME Y14.5 M-1994.
  - 2- DIMENSIONS ARE SHOWN IN INCHES (MILLIMETERS)
  - 3- LEAD DIMENSION AND FINISH UNCONTROLLED IN 1:1.
  - 4- DIMENSION D, DI & E DO NOT INCLUDE MOLD FLASH. MOLD FLASH SHALL NOT EXCEED .005" (0.127) PER SIDE. THESE DIMENSIONS ARE MEASURED AT THE OUTERMOST EXTREMES OF THE PLASTIC BODY.
  - 5- DIMENSION b1, b3 & c1 APPLY TO BASE METAL ONLY.
  - 6- CONTROLLING DIMENSION - INCHES.
  - 7- THERMAL PAD CONTOURS OPTIONAL WITHIN DIMENSIONS E1, D2 & E1.
  - 8- DIMENSION E2 x H1 DEFINE A ZONE WHERE STAMPING AND SINGULATION IRREGULARITIES ARE ALLOWED.
  - 9- OUTLINE CONFORMS TO JEDEC TO-220, EXCEPT A2 (max.) AND D2 (min.) WHERE DIMENSIONS ARE DERIVED FROM THE ACTUAL PACKAGE OUTLINE.

SYMBOL	DIMENSIONS				NOTES
	MILLIMETERS		INCHES		
	MIN.	MAX.	MIN.	MAX.	
A	3.56	4.83	.140	.190	
A1	0.51	1.40	.020	.055	
A2	2.03	2.92	.080	.115	
b	0.38	1.01	.015	.040	5
b1	0.38	0.91	.015	.036	
b2	1.14	1.78	.045	.070	
b3	1.14	1.73	.045	.068	5
c	0.36	0.61	.014	.024	
c1	0.26	0.56	.014	.022	5
D	14.22	16.61	.560	.650	4
D1	8.38	9.02	.330	.355	7
D2	11.68	12.88	.460	.507	7
E	9.65	10.67	.380	.420	4, 7
E1	6.86	8.89	.270	.350	7
E2	-	0.76	-	0.30	8
e	2.54 BSC	-	.100 BSC	-	
e1	2.54 BSC	-	.100 BSC	-	
H1	5.84	6.86	.230	.270	7, 8
L	12.70	14.73	.500	.580	
L1	3.56	4.06	.140	.160	3
MP	3.54	4.08	.139	.161	
Q	2.54	3.42	.100	.135	

### LEAD ASSIGNMENTS

- 1- GATE
- 2- DRN
- 3- SOURCE

### SEMI CONDUCTOR

- 1- GATE
- 2- COLLECTOR
- 3- EMITTER

- 1- ANODE
- 2- CATHODE
- 3- ANODE

## TO-220AB Part Marking Information

EXAMPLE: THIS IS AN IRF1010  
 LOT CODE 1789  
 ASSEMBLED ON WW 19, 1997  
 IN THE ASSEMBLY LINE 'C'  
**Note:** "P" in assembly line position indicates "Lead-Free"

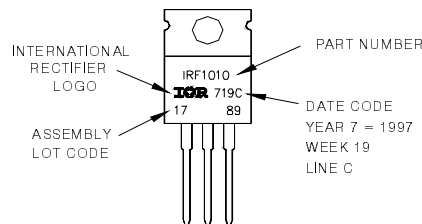

**Note:** For the most current drawing please refer to IR website at <http://www.irf.com/package/>

Data and specifications subject to change without notice.

International  
**IR** Rectifier

IR WORLD HEADQUARTERS: 233 Kansas St., El Segundo, California 90245, USA Tel: (310) 252-7105  
 TAC Fax: (310) 252-7903

Visit us at [www.irf.com](http://www.irf.com) for sales contact information.02/2010

# Mouser Electronics

Authorized Distributor

Click to View Pricing, Inventory, Delivery & Lifecycle Information:

[Infineon:](#)

[IRG4BC30UDPBF](#)