



High-Performance 24-Bit, 216kHz Sampling Stereo Audio Analog-to-Digital Converter

FEATURES

- Two High-Performance Delta-Sigma Analog-to-Digital Converters
 - 24-Bit Linear PCM or 1-Bit Direct Stream Digital (DSD) Output Data
 - Supports PCM Output Sampling Rates up to 216kHz
 - Supports 64f_S and 128f_S DSD Output Data Rates
- Dynamic Performance: PCM Output
 - Dynamic Range (V_{IN} = –60dBFS, f_{IN} = 1kHz, A-Weighted): 118dB
 - THD+N (V_{IN} = –0.5dB, f_{IN} = 1kHz): –105dB
- Dynamic Performance: DSD Output, 64f_S
 - Dynamic Range (A-Weighted): 115dB
 - THD+N (V_{IN} = –0.5dB, f_{IN} = 1kHz): –102dB
- Audio Serial Port
 - 24-Bit Linear PCM Output Data
 - Master or Slave Mode Operation
 - Supports Left-Justified, Right-Justified, and I²S™ Data Formats
- Additional PCM Output Features:
 - Linear-Phase Digital Decimation Filter
 - Digital High-Pass Filter for DC Removal
 - Clipping Flag Output for Each Channel
- Power Supplies: +5V Analog and +3.3V Digital
- Power Dissipation:
 - f_S = 48kHz: 308mW typical
 - f_S = 96kHz: 338mW typical
 - f_S = 192kHz: 318mW typical
- Power-Down Mode
- Available in a SSOP-28 Package
- Pin- and Function-Compatible with the PCM1804

APPLICATIONS

- Digital Recorders and Mixing Desks
- Digital Audio Effects Processors
- Broadcast Studio Equipment
- Surround-Sound Encoders
- High-End A/V Receivers

DESCRIPTION

The PCM4202 is a high-performance, stereo audio analog-to-digital (A/D) converter designed for professional and broadcast audio applications. The PCM4202 architecture utilizes a 1-bit delta-sigma modulator per channel, incorporating a novel density modulated dither scheme for improved dynamic performance.

The PCM4202 supports 24-bit linear PCM output data, with sampling frequencies up to 216kHz. The PCM4202 can also be configured to output either 64x or 128x oversampled, 1-bit direct stream digital (DSD) data for each channel. Support for PCM and DSD output formats makes the PCM4202 suitable for a variety of digital audio recording and processing applications.

The PCM4202 includes a flexible audio serial port interface, which supports standard audio data formats. Audio data format selection, sampling mode configuration, and high-pass filter functions are all programmed using dedicated control pins.

The PCM4202 operates from a +5V analog power supply and a +3.3V digital power supply. The digital I/O pins are compatible with +3.3V logic families. The PCM4202 is available in a small SSOP-28 package.



Please be aware that an important notice concerning availability, standard warranty, and use in critical applications of Texas Instruments semiconductor products and disclaimers thereto appears at the end of this data sheet.

I²S is a registered trademark of Royal Philips Electronics B.V., The Netherlands. All other trademarks are the property of their respective owners.



This integrated circuit can be damaged by ESD. Texas Instruments recommends that all integrated circuits be handled with appropriate precautions. Failure to observe proper handling and installation procedures can cause damage.

ESD damage can range from subtle performance degradation to complete device failure. Precision integrated circuits may be more susceptible to damage because very small parametric changes could cause the device not to meet its published specifications.

ABSOLUTE MAXIMUM RATINGS

over operating free-air temperature range unless otherwise noted⁽¹⁾

		PCM4202	UNIT
Supply voltage	V _{CC}	+6.0	V
	V _{DD}	+3.6	V
Ground voltage differences	(any AGND to DGND)	±0.1	V
Digital input voltage	FMT0, FMT1, S \bar{M} , FS0, FS1, FS2, SCKI, RST, HPFD, BCK, LRCK	-0.3 to (V _{DD} + 0.3)	V
Analog input voltage	V _{INL+} , V _{INL-} , V _{INR+} , V _{INR-}	-0.3 to (V _{CC} + 0.3)	V
Input current (any pin except supplies)		±10mA	V
Operating temperature range		-10 to +70	°C
Storage temperature range, T _{STG}		-65 to +150	°C

⁽¹⁾ Stresses above those listed under Absolute Maximum Ratings may cause permanent damage to the device. Exposure to absolute maximum conditions for extended periods may degrade device reliability. These are stress ratings only, and functional operation of the device at these or any other conditions beyond those specified is not implied.

PACKAGE/ORDERING INFORMATION

For the most current package and ordering information, see the Package Option Addendum located at the end of this datasheet.

PIN ASSIGNMENT

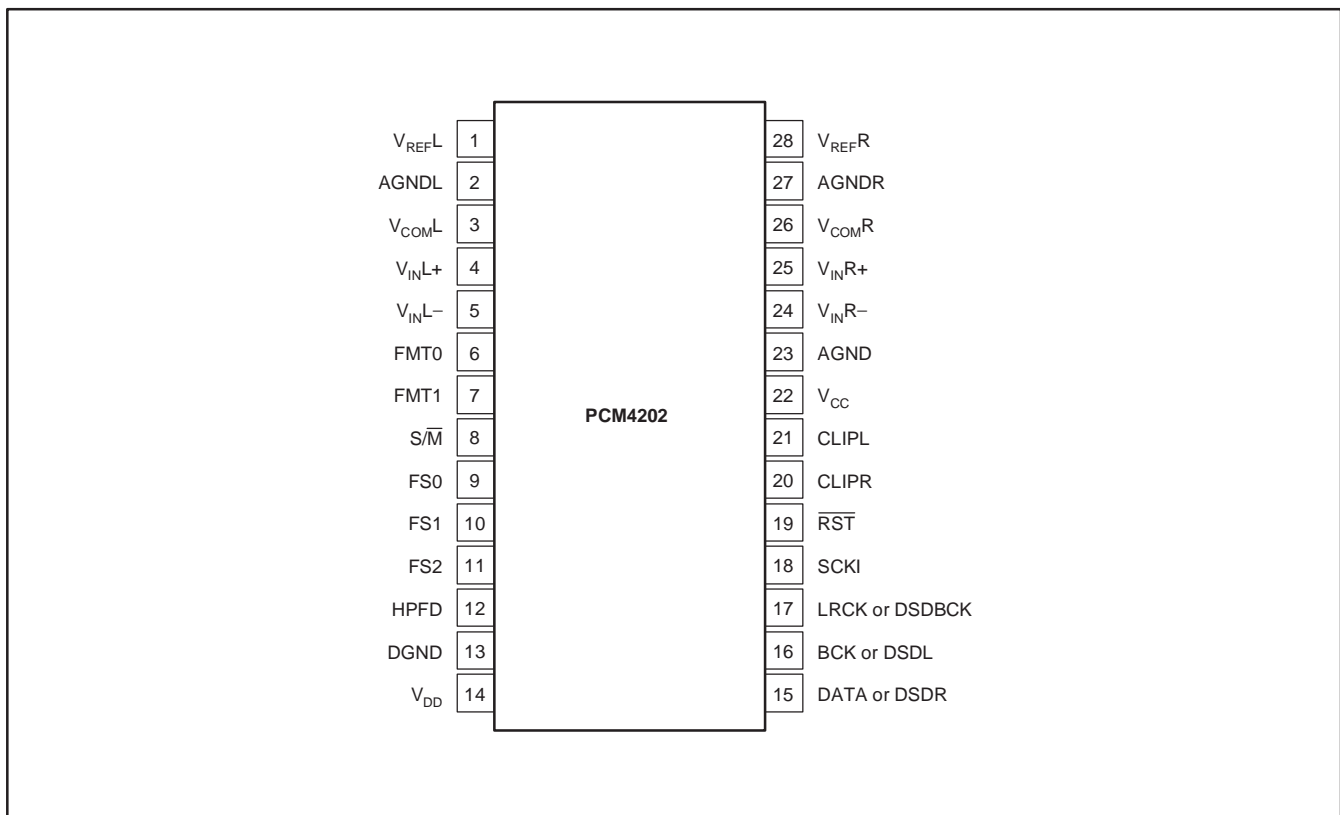

Terminal Functions

TERMINAL		I/O	DESCRIPTION
PIN NO.	NAME		
1	VREFL	Output	Left Channel Voltage Reference
2	AGNDL	Ground	Left Channel Reference Ground
3	VCOML	Output	Left Channel DC Common-mode Voltage, +2.5V Typical
4	VINL+	Input	Left Channel Non-inverting Analog Input
5	VINL-	Input	Left Channel Inverting Analog Input
6	FMT0	Input	Audio Data Format Selection
7	FMT1	Input	Audio Data Format Selection
8	S/M	Input	Audio Serial Port Slave/Master Mode Selection (0 = Master, 1 = Slave)
9	FS0	Input	Sampling Mode Selection
10	FS1	Input	Sampling Mode Selection
11	FS2	Input	Sampling Mode Selection
12	HPFD	Input	High-pass Filter Disable (Active High)
13	DGND	Ground	Digital Ground
14	VDD	Power	Digital Power Supply, +3.3V
15	DATA or DSDR	Output	Audio Serial Port Left and Right Channel PCM Data or Right Channel DSD Data
16	BCK or DSDL	I/O	Audio Serial Port Bit (or Data) Clock or Left Channel DSD Data Output
17	LRCK or DSDBCK	I/O	Audio Serial Port Left/Right (or Word) Clock or DSD Data Clock Output
18	SCKI	Input	System Clock
19	RST	Input	Reset/Power-down (Active Low with internal pull-up)
20	CLIPR	Output	Right Channel Clipping Flag (Active High)
21	CLIPL	Output	Left Channel Clipping Flag (Active High)
22	VCC	Power	Analog Power Supply, +5V
23	AGND	Ground	Analog Ground
24	VINR-	Input	Right Channel Inverting Analog Input
25	VINR+	Input	Right Channel Non-inverting Analog Input
26	VCOMR	Output	Right Channel DC Common-mode Voltage, +2.5V Typical
27	AGNDR	Ground	Right Channel Reference Ground
28	VREFR	Output	Right Channel Voltage Reference

ELECTRICAL CHARACTERISTICS

All parameters are specified at $T_A = +25^\circ\text{C}$ with $V_{CC} = +5\text{V}$, $V_{DD} = +3.3\text{V}$, and a measurement bandwidth from 20Hz to 20kHz, unless otherwise noted. System clock frequency is equal to $256f_S$ for Single and Dual Rate sampling modes, and $128f_S$ for Quad Rate sampling mode.

PARAMETER	CONDITIONS	PCM4202			UNITS	
		MIN	TYP	MAX		
RESOLUTION			24		Bits	
AUDIO DATA FORMAT						
Linear PCM interface formats	Two's complement, MSB first data	I^2S , Left or Right Justified				
Linear PCM word length			24		Bits	
Direct Stream Digital (DSD) output			1		Bit	
DIGITAL CHARACTERISTICS						
Input logic level	V_{IH}		$0.7 \times V_{DD}$		V_{DD}	
	V_{IL}		0		$0.3 \times V_{DD}$	
Output logic level	V_{OH}	$I_{OH} = -2\text{mA}$	$0.8 \times V_{DD}$		V_{DD}	
	V_{OL}	$I_{OL} = +2\text{mA}$			$0.2 \times V_{DD}$	
Input current	I_{IH}	$V_{IN} = V_{DD}$			+10 μA	
	I_{IL}	$V_{IN} = 0\text{V}$			-10 μA	
Input current ⁽¹⁾	I_{IH}	$V_{IN} = V_{DD}$			+25 μA	
	I_{IL}	$V_{IN} = 0\text{V}$			-25 μA	
Sampling frequency ⁽²⁾	f_S	Single rate	8		54 kHz	
		Dual rate	54		108 kHz	
		Quad rate	108		216 kHz	
System clock duty cycle			45	50	55	%
System clock frequency ⁽²⁾		Single rate, $SCKI = 256f_S$	2.048		13.824	MHz
		Single rate, $SCKI = 384f_S$	3.072		20.736	MHz
		Single rate, $SCKI = 512f_S$	4.096		27.648	MHz
		Single rate, $SCKI = 768f_S$	6.144		38.4	MHz
		Dual rate, $SCKI = 256f_S$	13.824		27.648	MHz
		Dual rate, $SCKI = 384f_S$	20.736		38.4	MHz
		Quad rate, $SCKI = 128f_S$	13.824		27.648	MHz
		Quad rate, $SCKI = 192f_S$	20.736		38.4	MHz
ANALOG OUTPUTS						
Input voltage, full-scale	Differential input		6.0		V_{PP}	
Input impedance			3		$k\Omega$	
Common-mode rejection			85		dB	
DC PERFORMANCE						
Output offset error	HPFD = 1		± 4		% of FSR	
Gain error			± 4		% of FSR	
Gain mismatch channel-to-channel			± 3		% of FSR	

(1) Applies to the \overline{RST} input, pin 19.

(2) Single, Dual, and Quad Rate sampling modes are described within this data sheet.

(3) Dynamic performance parameters are measured using an Audio Precision System Two Cascade or Cascade Plus test system. The measurement bandwidth is limited by using the Audio Precision 22Hz high-pass filter in combination with the Audio Precision 20kHz, $f_S/2$, or a user-defined 40kHz low-pass filter. All A-weighted measurements are performed using the Audio Precision A-weighting filter in combination with the previously mentioned filters.

ELECTRICAL CHARACTERISTICS (continued)

All parameters are specified at $T_A = +25^\circ\text{C}$ with $V_{CC} = +5\text{V}$, $V_{DD} = +3.3\text{V}$, and a measurement bandwidth from 20Hz to 20kHz, unless otherwise noted. System clock frequency is equal to $256f_S$ for Single and Dual Rate sampling modes, and $128f_S$ for Quad Rate sampling mode.

PARAMETER	CONDITIONS	PCM4202			UNITS	
		MIN	TYP	MAX		
DYNAMIC PERFORMANCE⁽³⁾						
$f_S = 48\text{kHz}$, Single Rate		BW = 20Hz to 20kHz				
Total harmonic distortion + noise	THD+N	$V_{IN} = -0.5\text{dBFS}$, $f_{IN} = 1\text{kHz}$		-105	-95	dB
Dynamic range		$V_{IN} = -60\text{dBFS}$, $f_{IN} = 1\text{kHz}$, A-Weighted	112	118		dB
Dynamic range, no weighting		$V_{IN} = -60\text{dBFS}$, $f_{IN} = 1\text{kHz}$		116		dB
Channel separation			100	120		dB
$f_S = 96\text{kHz}$, Dual Rate		BW = 20Hz to 40kHz				
Total harmonic distortion + noise	THD+N	$V_{IN} = -0.5\text{dBFS}$, $f_{IN} = 1\text{kHz}$		-105		dB
Dynamic range		$V_{IN} = -60\text{dBFS}$, $f_{IN} = 1\text{kHz}$, A-Weighted		118		dB
Dynamic range, no weighting		$V_{IN} = -60\text{dBFS}$, $f_{IN} = 1\text{kHz}$		112		dB
Channel separation				120		dB
$f_S = 192\text{kHz}$, Quad Rate		BW = 20Hz to 40kHz				
Total harmonic distortion + noise	THD+N	$V_{IN} = -0.5\text{dBFS}$, $f_{IN} = 1\text{kHz}$		-103		dB
Dynamic range		$V_{IN} = 0V_{RMS}$, A-Weighted		117		dB
Dynamic range, no weighting		$V_{IN} = 0V_{RMS}$		108		dB
Channel separation				120		dB
DSD Output, $64f_S$ Rate		DSDBCK = 2.8224MHz				
Total harmonic distortion + noise	THD+N	$V_{IN} = -0.5\text{dBFS}$, $f_{IN} = 1\text{kHz}$		-102		dB
Dynamic range		$V_{IN} = -60\text{dBFS}$, $f_{IN} = 1\text{kHz}$, A-Weighted		115		dB
Channel separation				120		dB
DSD Output, $128f_S$ Rate		DSDBCK = 5.6448MHz				
Total harmonic distortion + noise	THD+N	$V_{IN} = -0.5\text{dBFS}$, $f_{IN} = 1\text{kHz}$		-105		dB
Dynamic range		$V_{IN} = -60\text{dBFS}$, $f_{IN} = 1\text{kHz}$, A-Weighted		118		dB
Channel separation				120		dB

(1) Applies to the $\overline{\text{RST}}$ input, pin 19.

(2) Single, Dual, and Quad Rate sampling modes are described within this data sheet.

(3) Dynamic performance parameters are measured using an Audio Precision System Two Cascade or Cascade Plus test system. The measurement bandwidth is limited by using the Audio Precision 22Hz high-pass filter in combination with the Audio Precision 20kHz, $f_S/2$, or a user-defined 40kHz low-pass filter. All A-weighted measurements are performed using the Audio Precision A-weighting filter in combination with the previously mentioned filters.

ELECTRICAL CHARACTERISTICS (continued)

All parameters are specified at $T_A = +25^\circ\text{C}$ with $V_{CC} = +5\text{V}$, $V_{DD} = +3.3\text{V}$, and a measurement bandwidth from 20Hz to 20kHz, unless otherwise noted. System clock frequency is equal to $256f_S$ for Single and Dual Rate sampling modes, and $128f_S$ for Quad Rate sampling mode.

PARAMETER	CONDITIONS	PCM4202			UNITS
		MIN	TYP	MAX	
DIGITAL DECIMATION FILTER					
Passband edge	Single and Dual Rate			0.453 f_S	Hz
Passband ripple	Single and Dual Rate			± 0.005	dB
Passband edge	Single and Dual Rate	0.547 f_S			Hz
Stop band attenuation	Single and Dual Rate	-100			dB
Group delay	Single and Dual Rate		37/ f_S		sec
Passband edge (-0.005dB)	Quad Rate			0.375 f_S	Hz
-3dB cutoff frequency	Quad Rate			0.490 f_S	Hz
Passband ripple	Quad Rate			± 0.005	dB
Passband edge	Quad Rate	0.770 f_S			Hz
Stop band attenuation	Quad Rate	-135			dB
Group delay	Quad Rate		9.5/ f_S		sec
DIGITAL HIGH PASS FILTER					
Frequency response (-3dB)			$f_S/48000$		Hz
POWER SUPPLY					
Voltage range	V_{CC}	+4.75	+5.0	+5.25	VDC
	V_{DD}	+3.0	+3.3	+3.6	VDC
Operating supply current	$V_{CC} = +5\text{V}$, $V_{DD} = +3.3\text{V}$				
	$f_S = 48\text{kHz}$, Single Rate		55	65	mA
	$f_S = 96\text{kHz}$, Dual Rate		55	65	mA
	$f_S = 192\text{kHz}$, Quad Rate		55	65	mA
	$V_{CC} = +5\text{V}$, $V_{DD} = +3.3\text{V}$				
	$f_S = 48\text{kHz}$, Single Rate		10	12	mA
	$f_S = 96\text{kHz}$, Dual Rate		19	25	mA
	$f_S = 192\text{kHz}$, Quad Rate		13	15	mA
Power-down mode current	$V_{CC} = +5\text{V}$, $V_{DD} = +3.3\text{V}$, $\overline{\text{RST}} = 0$				
	I_{CC} Clocks applied			10	mA
	I_{DD} Clocks applied			2	mA
Total power dissipation	$V_{CC} = +5\text{V}$, $V_{DD} = +3.3\text{V}$				
	$f_S = 48\text{kHz}$, Single Rate		308	365	mW
	$f_S = 96\text{kHz}$, Dual Rate		338	408	mW
	$f_S = 192\text{kHz}$, Quad Rate		318	375	mW

(1) Applies to the $\overline{\text{RST}}$ input, pin 19.

(2) Single, Dual, and Quad Rate sampling modes are described within this data sheet.

(3) Dynamic performance parameters are measured using an Audio Precision System Two Cascade or Cascade Plus test system. The measurement bandwidth is limited by using the Audio Precision 22Hz high-pass filter in combination with the Audio Precision 20kHz, $f_S/2$, or a user-defined 40kHz low-pass filter. All A-weighted measurements are performed using the Audio Precision A-weighting filter in combination with the previously mentioned filters.

TYPICAL CHARACTERISTICS

At $T_A = +25^\circ\text{C}$ with $V_{CC} = +5\text{V}$, $V_{DD} = +3.3\text{V}$, and a measurement bandwidth from 20Hz to 20kHz, unless otherwise noted.

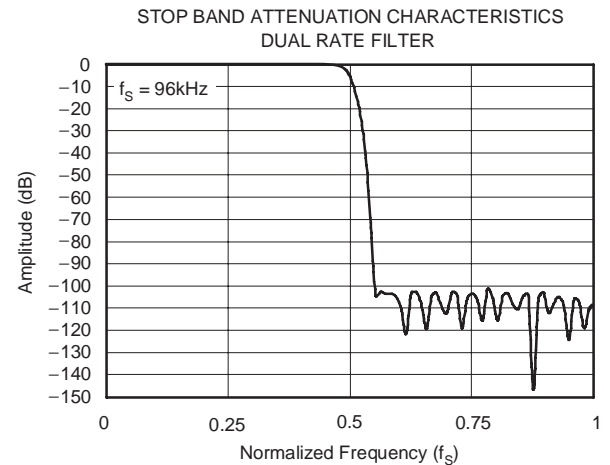
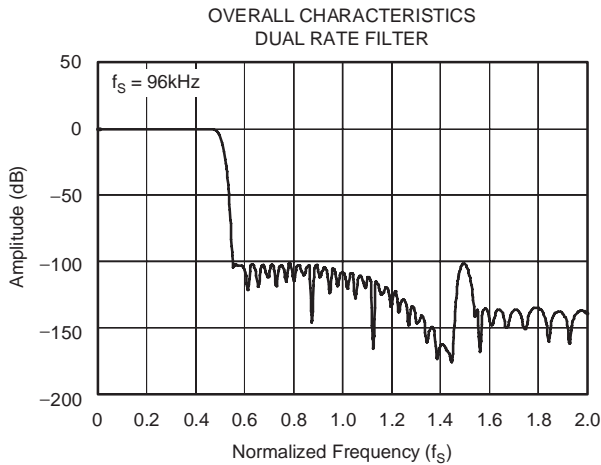
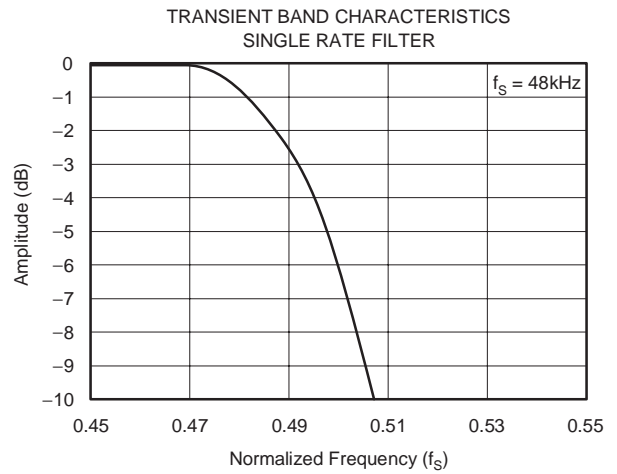
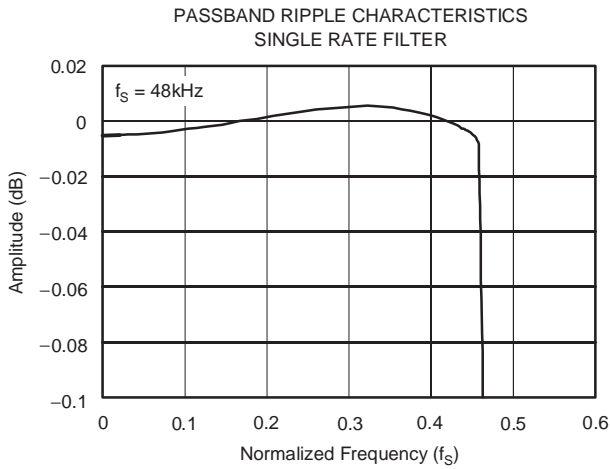
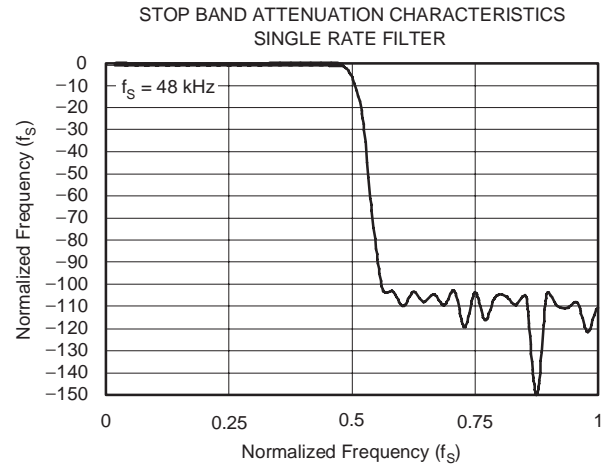
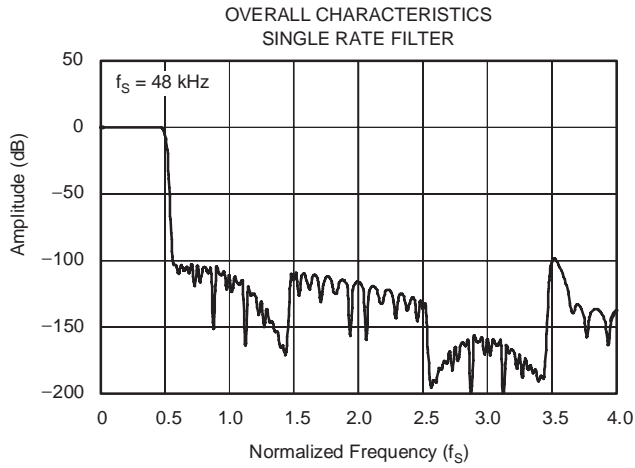

TYPICAL CHARACTERISTICS (continued)

At $T_A = +25^\circ\text{C}$ with $V_{CC} = +5\text{V}$, $V_{DD} = +3.3\text{V}$, and a measurement bandwidth from 20Hz to 20kHz, unless otherwise noted.

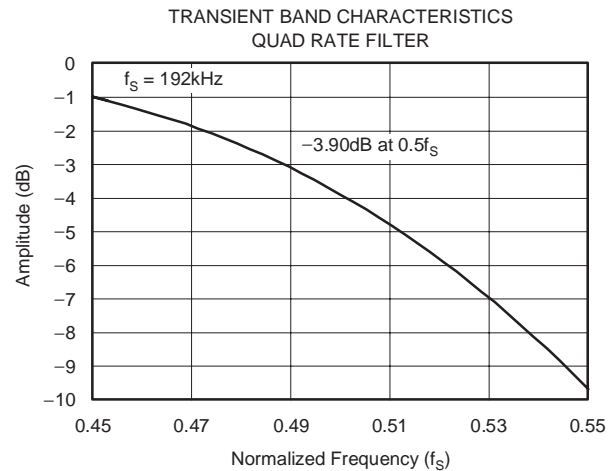
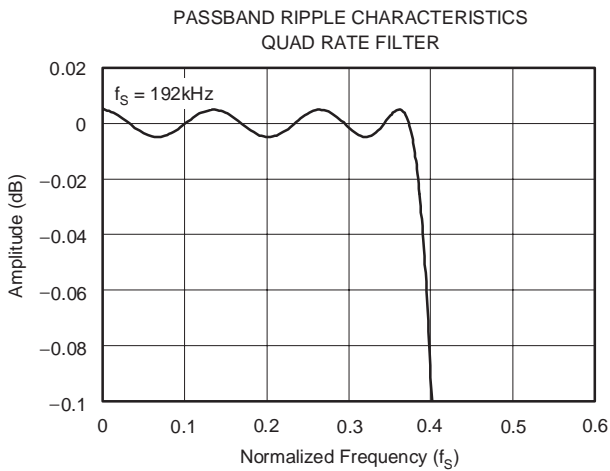
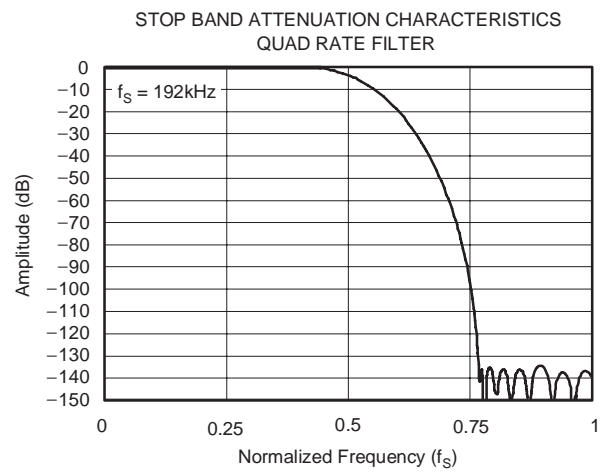
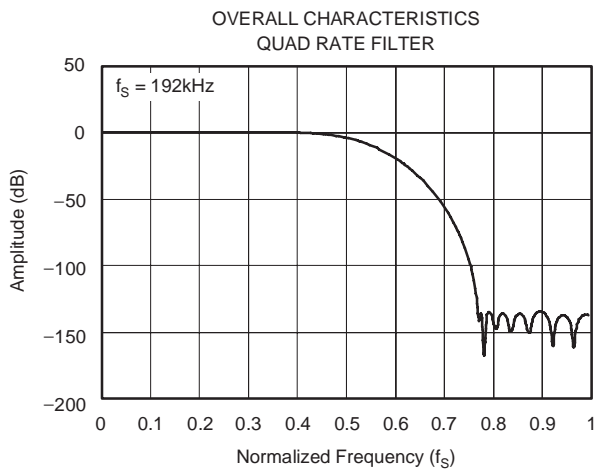
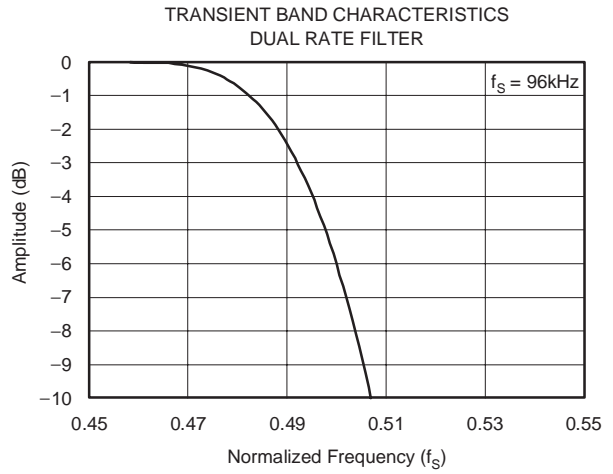
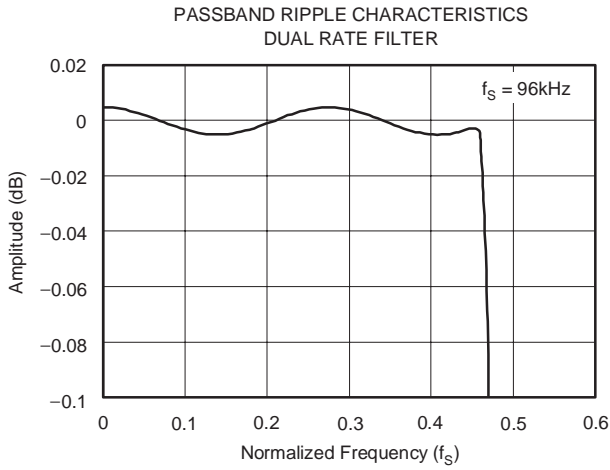

TYPICAL CHARACTERISTICS (continued)

At $T_A = +25^\circ\text{C}$ with $V_{CC} = +5\text{V}$, $V_{DD} = +3.3\text{V}$, and a measurement bandwidth from 20Hz to 20kHz, unless otherwise noted.

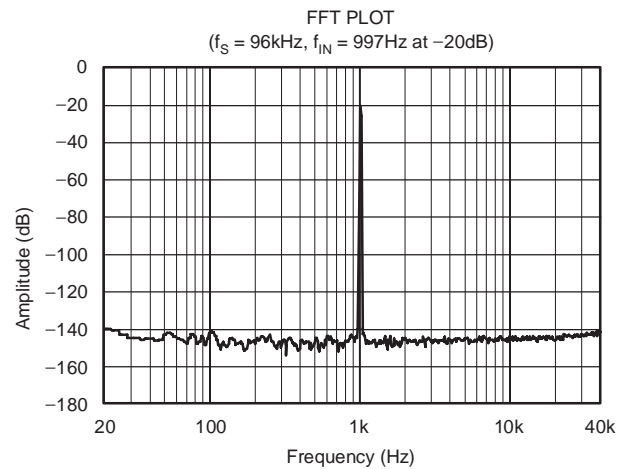
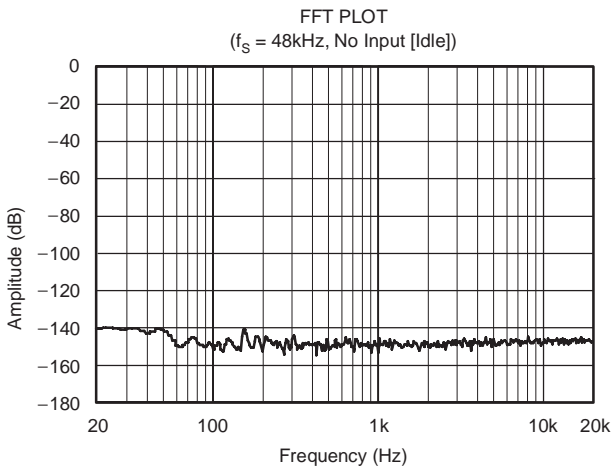
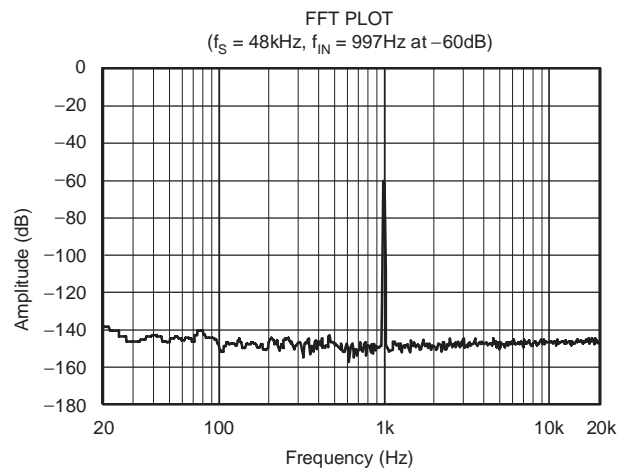
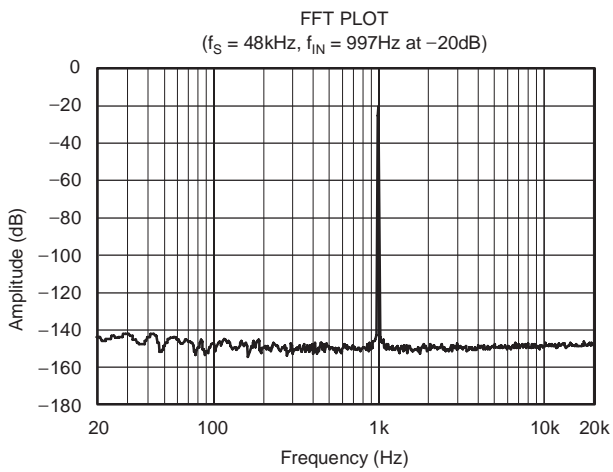
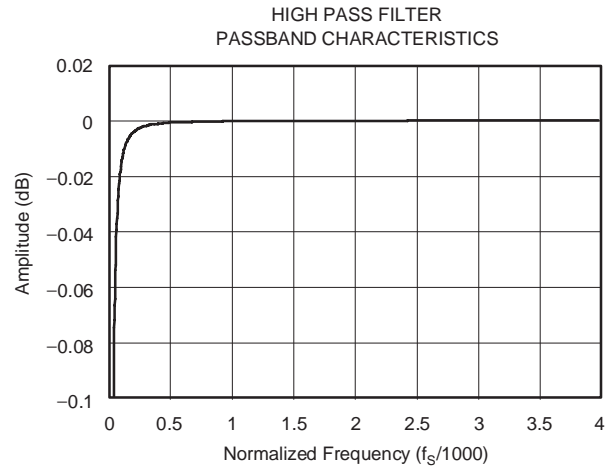
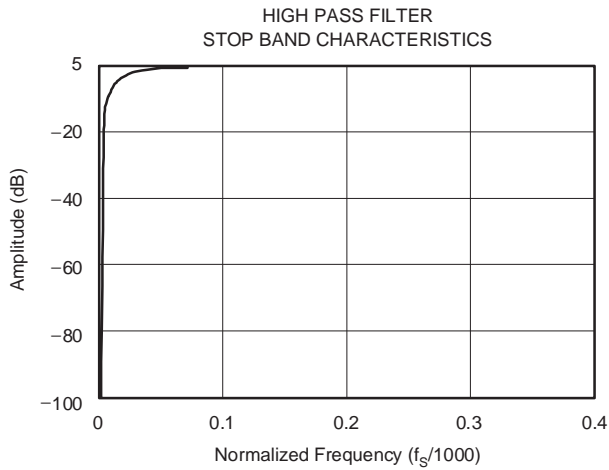

TYPICAL CHARACTERISTICS (continued)

At $T_A = +25^\circ\text{C}$ with $V_{CC} = +5\text{V}$, $V_{DD} = +3.3\text{V}$, and a measurement bandwidth from 20Hz to 20kHz, unless otherwise noted.

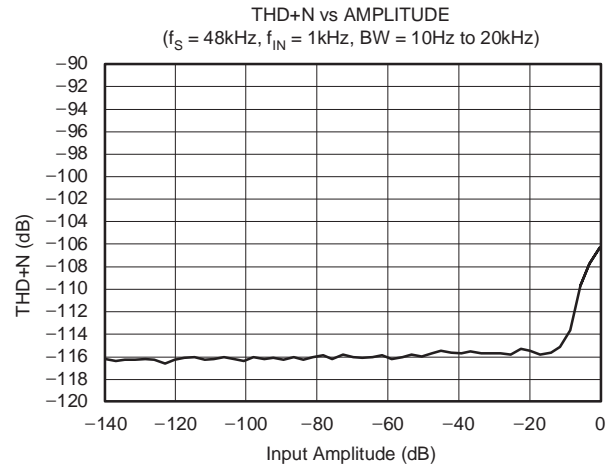
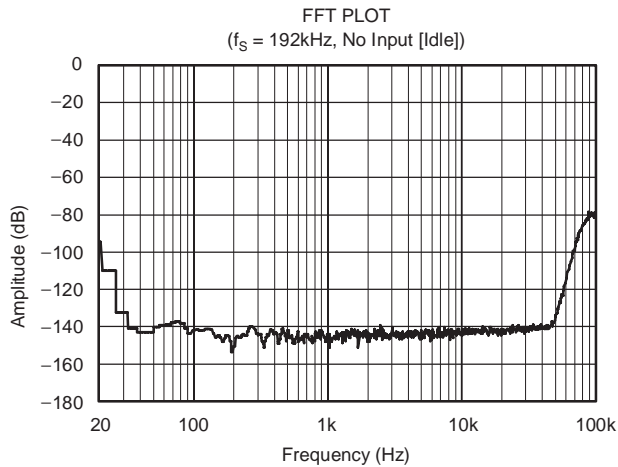
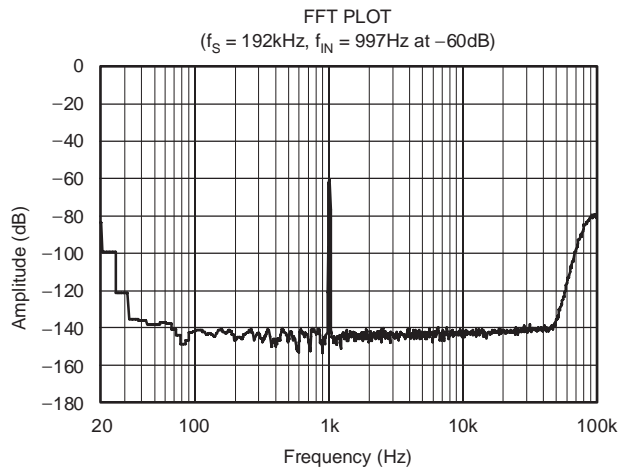
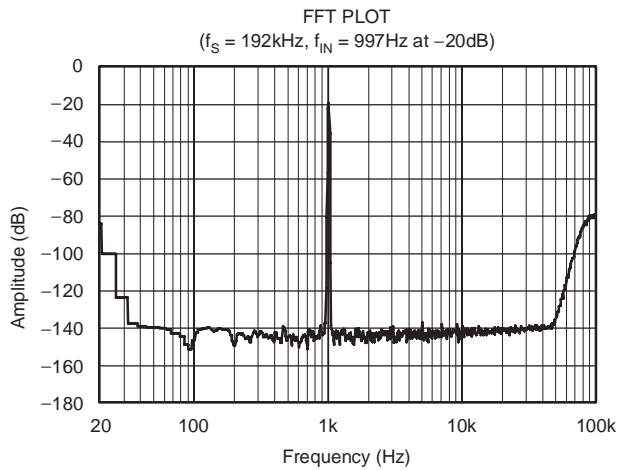
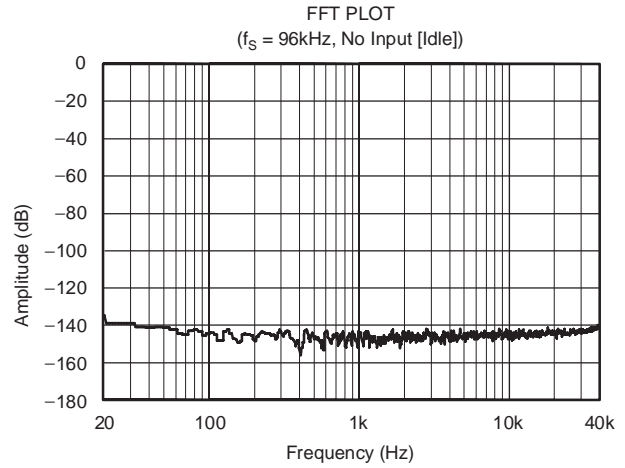
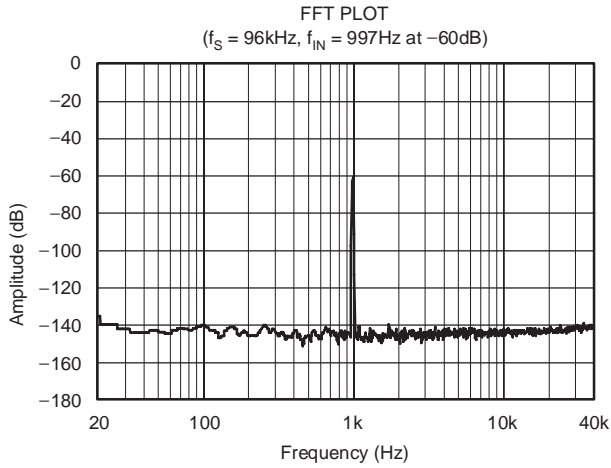

TYPICAL CHARACTERISTICS (continued)

At $T_A = +25^\circ\text{C}$ with $V_{CC} = +5\text{V}$, $V_{DD} = +3.3\text{V}$, and a measurement bandwidth from 20Hz to 20kHz, unless otherwise noted.

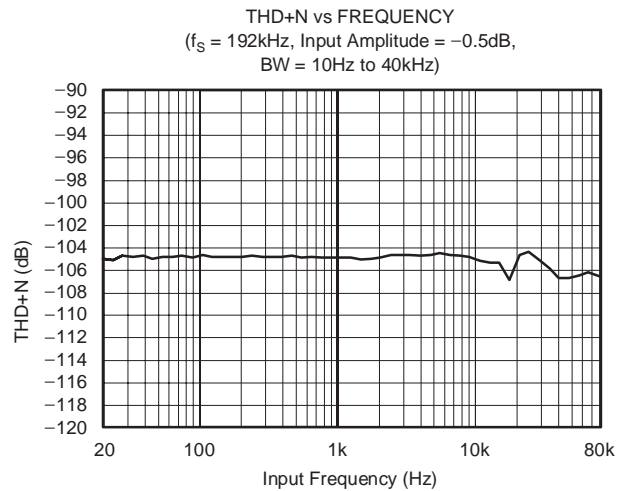
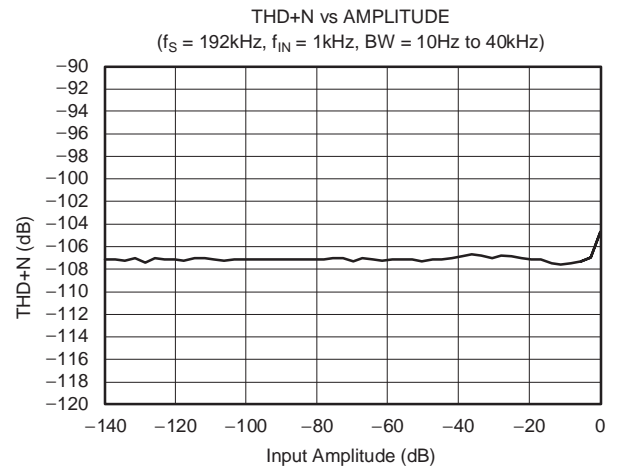
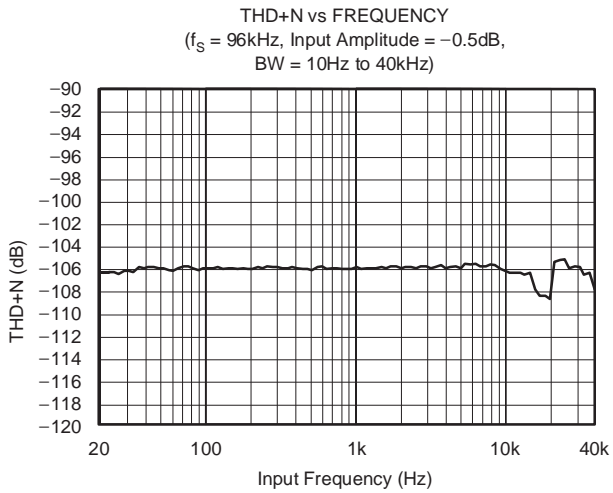
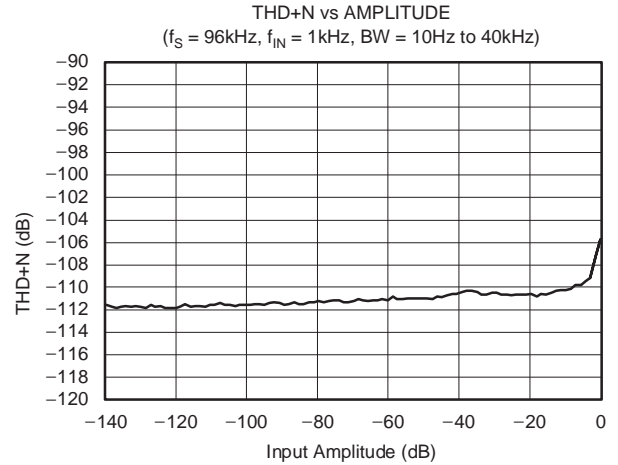
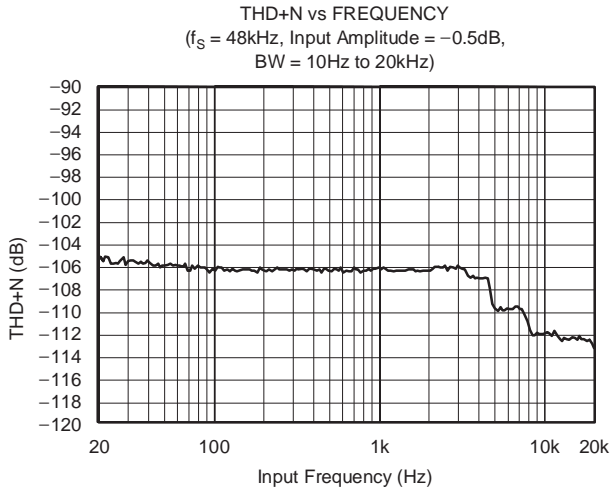

PRODUCT OVERVIEW

The PCM4202 is a high-performance, stereo audio analog-to-digital (A/D) converter designed for use in professional and broadcast audio applications. The PCM4202 features 24-bit linear PCM or 1-bit Direct Stream Digital (DSD) data output capability for both channels. Sampling rates up to 216kHz are supported for PCM output formats, while 64x or 128x oversampled 1-bit data is supported for DSD output mode. Native support for both PCM and DSD data formats makes the PCM4202 ideal for use in a wide variety of audio recording and processing applications.

The PCM4202 features 1-bit delta-sigma modulators employing density modulated dither for improved dynamic performance. Differential voltage inputs are utilized for the modulators, providing excellent common-mode rejection. On-chip voltage references are provided for the

modulators, in addition to generating DC common-mode bias voltage outputs for use with external input circuitry. Linear phase digital decimation filtering is provided for the 24-bit PCM data outputs, with a minimum stop band attenuation of -100dB for all sampling modes.

The PCM output mode features clipping flag outputs for each channel, as well as a digital high-pass filter for DC removal. The PCM4202 may be configured using dedicated input pins for sampling mode and audio data format selection, high-pass filter enable/disable, and reset/power-down operation.

A +5V power supply is required for the analog section of the device, while a +3.3V power supply is required for the digital circuitry. Figure 1 shows the functional block diagram for the PCM4202.

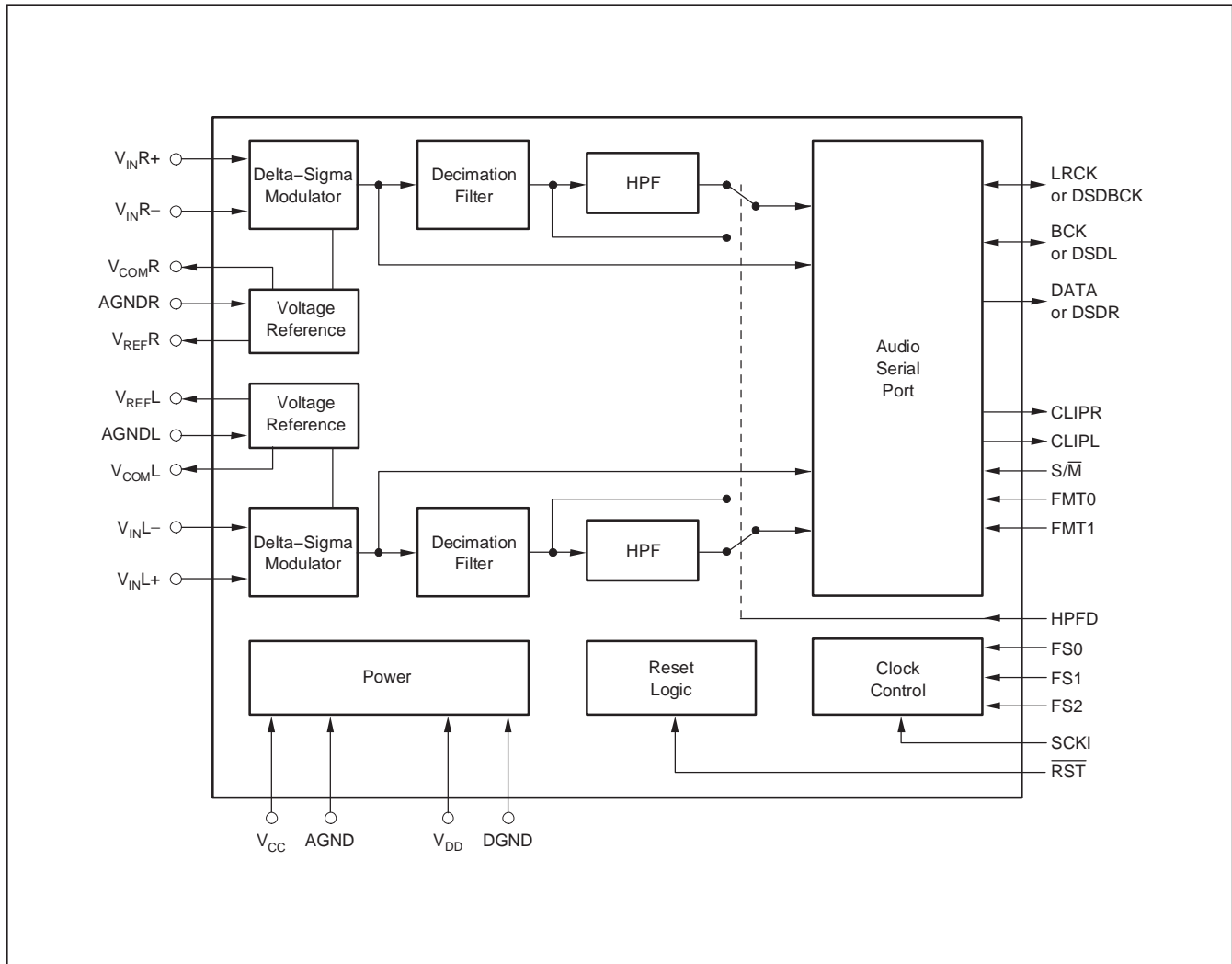

Figure 1. PCM4202 Functional Block Diagram

ANALOG INPUTS

The PCM4202 includes two channels of A/D conversion, each with its own pair of differential voltage input pins. The V_{INL+} (pin 4) and V_{INL-} (pin 5) inputs correspond to Left channel input, while V_{INR+} (pin 25) and V_{INR-} (pin 24) correspond to the Right channel input. The average input impedance of each input pin is $3k\Omega$.

Each analog input pair accepts a full-scale input voltage of approximately $6.0V_{PP}$ differential, which corresponds to a $2.12V_{RMS}$ or $+8.75dBu$ input swing. The analog input should not swing below analog ground or above the V_{CC} power supply by more than $300mV$. Refer to the **Applications Information** section of this datasheet for an example input buffer circuit.

VOLTAGE REFERENCES AND COMMON MODE BIAS VOLTAGE OUTPUTS

The PCM4202 includes two on-chip voltage references, one each for the Left and Right channels. The V_{REFL} (pin 1) and V_{REFR} (pin 28) outputs correspond to high reference outputs for Left and Right channels, respectively. De-coupling capacitors are connected between each of these pins and the corresponding reference ground pin, either AGNDL (pin 2) for the V_{REFL} output or AGNDR (pin 27) for the V_{REFR} output. It is recommended to have at least a $0.1\mu F$ X7R ceramic chip capacitor connected in parallel with a $33\mu F$ low ESR tantalum chip capacitor for de-coupling purposes. The V_{REFL} and V_{REFR} outputs should not be utilized to bias external circuitry, because they are not buffered. Use the V_{COML} (pin 3) and V_{COMR} (pin 26) outputs to bias external circuitry, as described in the following paragraphs.

Refer to the **Applications Information** section of this datasheet for the recommended voltage reference pin connections.

The PCM4202 analog inputs are internally biased to approximately $V_{CC}/2$. This bias voltage is referred to as the common mode voltage, and is output at V_{COML} (pin 3) and V_{COMR} (pin 26), corresponding to the Left and Right channels, respectively. These outputs provide a level shifting voltage for biasing external input buffer circuitry. Although the V_{COML} and V_{COMR} outputs are internally buffered, the output current is limited to a few hundred μA . It is recommended to connect these pins to external nodes with greater than $1M\Omega$ impedance, or to buffer the outputs with a voltage follower circuit when driving multiple external or low impedance nodes.

Refer to the **Applications Information** section of this datasheet for an example input buffer circuit that utilizes the common-mode bias voltage outputs.

SYSTEM CLOCK INPUT

The PCM4202 requires an external system clock, from which the modulator oversampling and digital sub-system clocks are derived. The system clock is applied at the SCKI input (pin 18). The frequency of the system clock is dependent upon the desired PCM output sampling frequency or DSD data rate, along with the sampling mode selection. Table 1 shows the corresponding system clock frequencies for common output sampling and data rates, along with the corresponding sampling modes. Timing requirements for the system clock are shown in Figure 2.

Table 1. System Clock Frequencies for Common Output Sampling and Data Rates

SAMPLING MODE	SAMPLING FREQUENCY, f_S (kHz)	SYSTEM CLOCK FREQUENCY (MHz)					
		128 f_S	192 f_S	256 f_S	384 f_S	512 f_S	768 f_S
Single Rate	32	n/a	n/a	8.192	12.288	16.384	24.576
Single Rate	44.1	n/a	n/a	11.2896	16.9344	22.5792	33.8688
Single Rate	48	n/a	n/a	12.288	18.432	24.576	36.864
Dual Rate	88.2	n/a	n/a	22.5792	33.8688	n/a	n/a
Dual Rate	96	n/a	n/a	24.576	36.864	n/a	n/a
Quad Rate	176.4	22.5792	33.8688	n/a	n/a	n/a	n/a
Quad Rate	192	24.576	36.864	n/a	n/a	n/a	n/a
DSD Output	128 f_S Data (Single Rate)	n/a	n/a	11.2896	16.9344	22.5792	33.8688
DSD Output	64 f_S Data (Dual Rate)	n/a	n/a	11.2896	16.9344	n/a	n/a

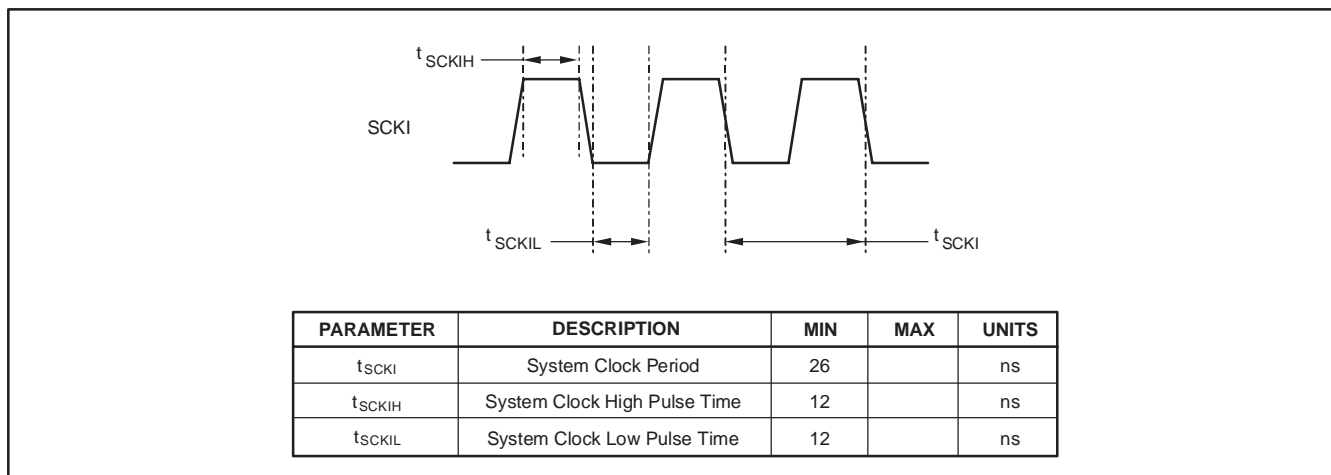

Figure 2. System Clock Timing Requirements

SAMPLING MODES

The PCM4202 may be operated in one of three PCM sampling modes, or at one of two DSD output data rates. The PCM sampling modes are referred to as Single Rate, Dual Rate, and Quad Rate.

Single Rate mode is utilized for sampling rates up to 54kHz. The delta-sigma modulator oversamples the analog input signal by a rate equal to 128 times the desired output sampling rate.

Dual Rate mode is utilized for sampling rates higher than 54kHz and up to 108kHz. The delta-sigma modulator oversamples the analog input signal by a rate equal to 64 times the desired output sampling rate.

Quad Rate mode is utilized for sampling frequencies higher than 108kHz and up to 216kHz. The delta-sigma modulator oversamples the analog input signal by a rate equal to 32 times the desired output sampling rate.

For DSD output data, the user may select either $64f_s$ or $128f_s$ oversampled data rates, where f_s is the base sampling rate, which is 44.1kHz for Super Audio CD (SACD) applications. The $64f_s$ data rate is analogous to the Dual Rate PCM sampling mode, where the analog input signal is oversampled by a rate equal to 64 times the base sampling rate. The $128f_s$ data rate corresponds to the Single Rate PCM sampling mode, where the analog input signal is oversampled by a rate equal to 128 times the base sampling rate.

Table 1 indicates the sampling mode utilized for common system clock and sampling rate combinations. The FS0 (pin 9), FS1 (pin 10), and FS2 (pin 11) inputs are utilized to select the sampling mode for the PCM4202. If the state of the sampling mode pins is changed any time after power-up reset initialization, the user should issue an external forced reset to re-initialize the PCM4202. Table 2,

Table 3, and Table 4 indicate the sampling mode selections for PCM Master and Slave mode operation, as well as the DSD Output mode.

Table 2. Sampling Mode Selection for PCM Master Mode Operation

FS2	FS1	FS0	SAMPLING MODE WITH SYSTEM CLOCK RATE
0	0	0	Single Rate with $f_{SCKI} = 768f_s$
0	0	1	Single Rate with $f_{SCKI} = 512f_s$
0	1	0	Single Rate with $f_{SCKI} = 384f_s$
0	1	1	Single Rate with $f_{SCKI} = 256f_s$
1	0	0	Dual Rate with $f_{SCKI} = 384f_s$
1	0	1	Dual Rate with $f_{SCKI} = 256f_s$
1	1	0	Quad Rate with $f_{SCKI} = 192f_s$
1	1	1	Quad Rate with $f_{SCKI} = 128f_s$

Table 3. Sampling Mode Selection for PCM Slave Mode Operation

FS2	FS1	FS0	SAMPLING MODE
0	0	0	Single Rate with Clock Auto-Detection
0	0	1	Dual Rate with Clock Auto-Detection
0	1	0	Quad Rate with Clock Auto-Detection
0	1	1	Reserved
1	0	0	Reserved
1	0	1	Reserved
1	1	0	Reserved
1	1	1	Reserved

Table 4. Sampling Mode Selection for DSD Output Mode Operation

FS2	FS1	FS0	SAMPLING MODE
0	0	0	128f _S DSD Output Rate with f _{SCKI} = 768f _S
0	0	1	128f _S DSD Output Rate with f _{SCKI} = 512f _S
0	1	0	128f _S DSD Output Rate with f _{SCKI} = 384f _S
0	1	1	128f _S DSD Output Rate with f _{SCKI} = 256f _S
1	0	0	64f _S DSD Output Rate with f _{SCKI} = 384f _S
1	0	1	64f _S DSD Output Rate with f _{SCKI} = 256f _S
1	1	0	Reserved
1	1	1	Reserved

In Slave mode, the PCM bit and left/right clocks (BCK and LRCK) are configured as input pins. DSD data formats are not supported in Slave mode. Slave mode supports commonly used PCM audio data formats, including Left Justified, Right Justified, and Philips I²S.

In Master mode, the PCM bit and left/right clocks (BCK and LRCK respectively) are configured as output pins, and are derived from the system clock input (SCKI). Alternatively, the DSD output data may be provided at the port output.

Table 5 shows the available data format selections. Figure 3 and Figure 4 illustrate the PCM and DSD data formats.

AUDIO DATA FORMATS

As mentioned previously, the PCM4202 supports 24-bit linear PCM output data, as well as 1-bit DSD output data. The available data formats are dependent upon whether the PCM4202 is configured in Slave or Master mode. The S/M (pin 8), FMT0 (pin 6), and FMT1 (pin 7) inputs are utilized to select either Slave or Master mode and the corresponding audio data format.

Table 5. Audio Data Format Selection

FMT1	FMT0	AUDIO DATA FORMAT
0	0	24-bit Left Justified
0	1	24-bit I ² S
1	0	24-bit Right Justified
1	1	1-bit DSD (Master Mode Only)

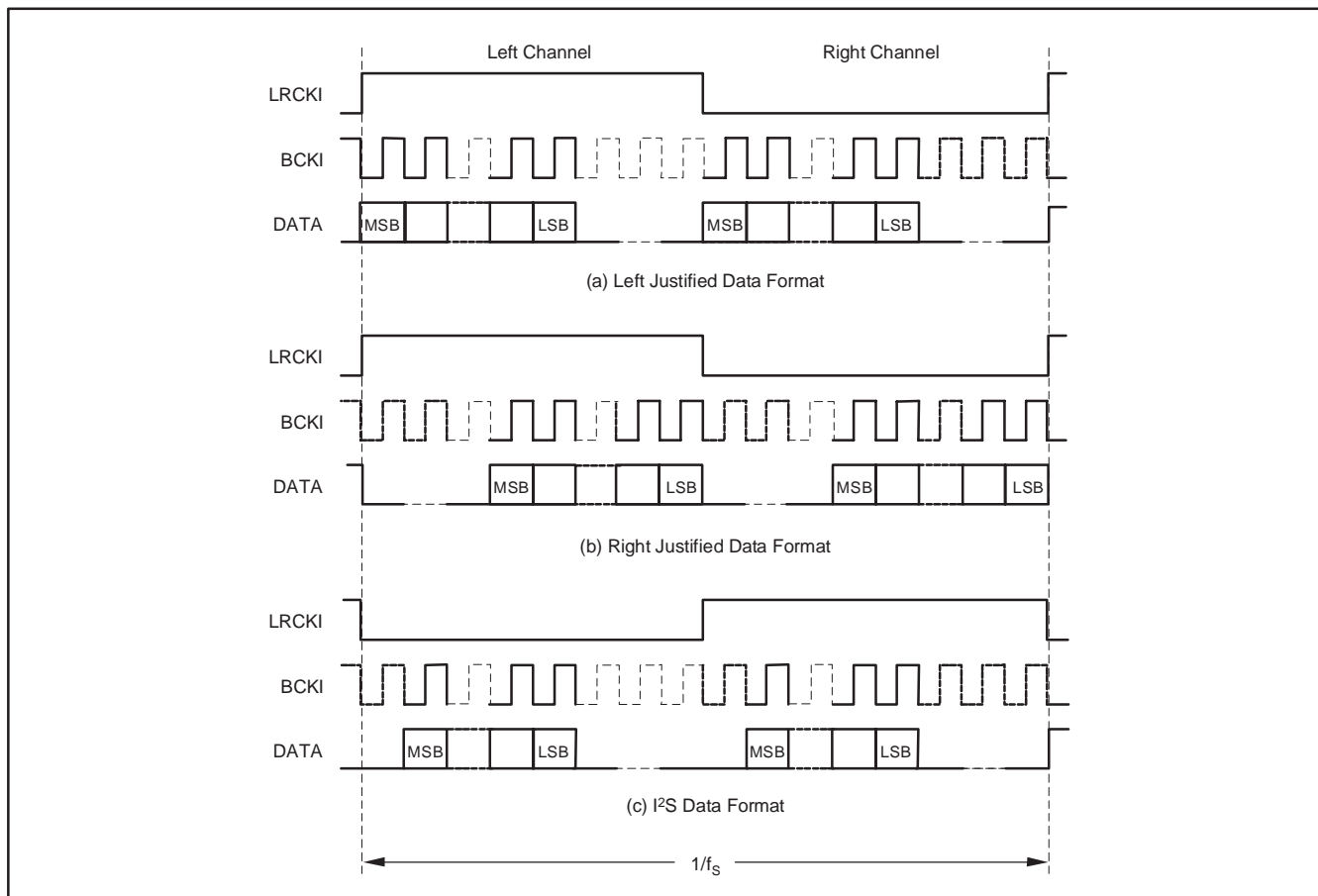

Figure 3. PCM Data Formats: Left Justified, Right Justified, and Philips I²S

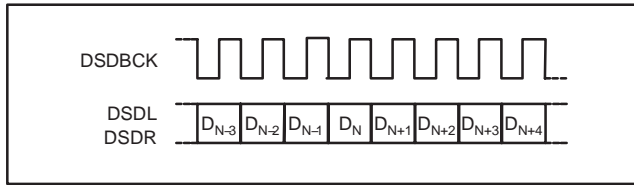

Figure 4. DSD Output Data Format

AUDIO SERIAL PORT OPERATION

This section provides additional details regarding the PCM4202 audio serial port, utilized for 24-bit linear PCM or 1-bit DSD output data. PCM output operation will be described in this section, while DSD output mode operation will be described in the following section.

For PCM data formats, the serial port is comprised of three signals: BCK (pin 16), LRCK (pin 17), and DATA (pin 15). The BCK signal functions as the data (or bit) clock for the serial audio data. The LRCK is the left/right word clock for the audio serial port. The LRCK and BCK clocks must be synchronous. The DATA signal is the serial audio data output, with data being clocked out on the falling edge of the BCK signal. DATA carries audio data for both the Left and Right channels.

As mentioned in the Audio Data Format section of this datasheet, the audio serial port can operate in Master or Slave mode. In Master mode, the BCK and LRCK clock signals are outputs, derived from the system clock input, SCKI. The BCK clock is fixed at $128f_S$ for Single Rate sampling mode, and at $64f_S$ for Dual or Quad Rate sampling modes. The LRCK clock operates at f_S , the output sampling rate (that is, 48kHz, 96kHz, etc.).

In Slave mode, the BCK and LRCK signals are inputs, with the clocks being generated by a master timing source, such as a DSP serial port, PLL clock synthesizer, or a crystal oscillator/divider circuit. The BCK rate is typically equal to $128f_S$ in Single Rate sampling mode, and $64f_S$ in Dual or Quad Rate sampling modes. Although other BCK clock rates are possible, they are not recommended as a result of potential clock phase sensitivity issues, which can degrade the dynamic performance of the PCM4202. The LRCK clock must be operated at f_S , the output sampling rate.

Figure 5 illustrates the typical audio serial port connections between a PCM4202 and an audio signal processor when using the PCM output data formats. Figure 6 illustrates the audio serial port timing for both the Master and Slave modes of operation.

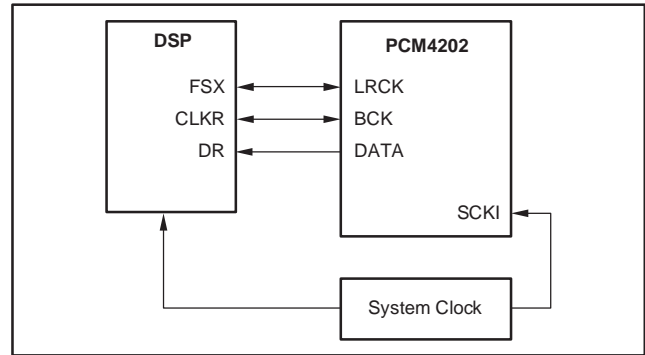

Figure 5. Typical Audio Serial Port Connections for Left Justified, Right Justified, and I²S Data Formats

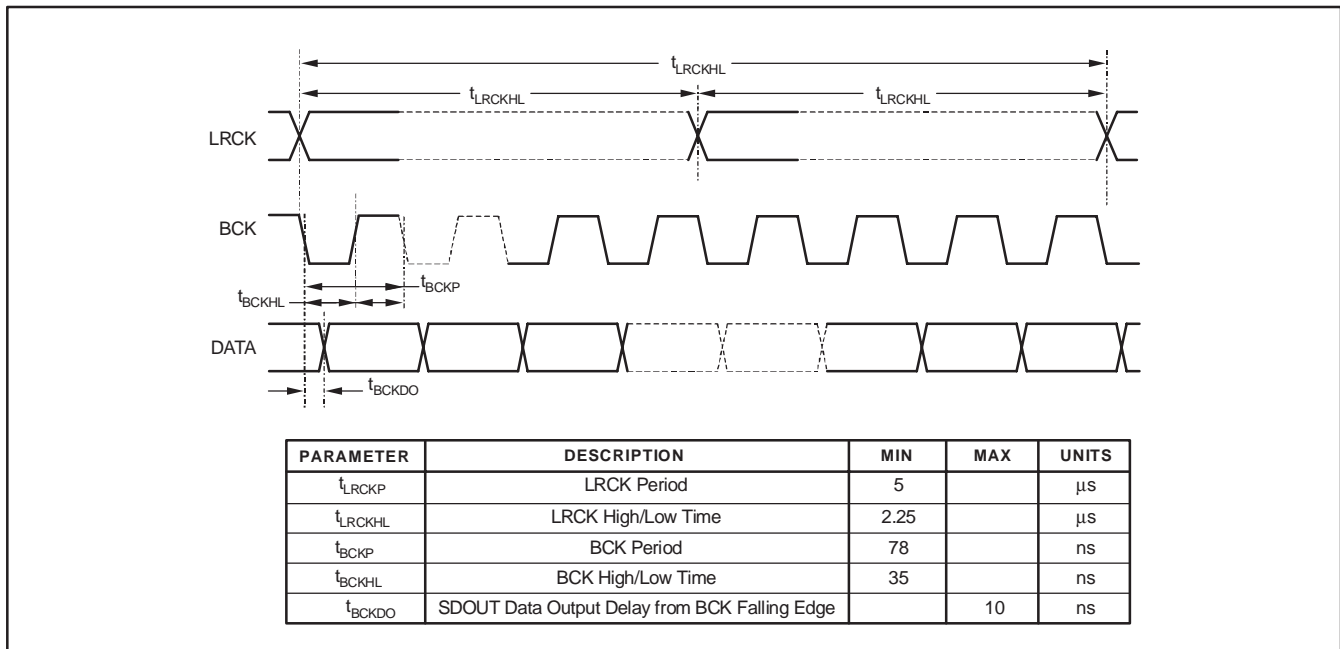

Figure 6. Master and Slave Mode Audio Serial Port Timing: Left Justified, Right Justified, and Philips I²S

DSD OUTPUT MODE OPERATION

The output port DSD mode operation consists of a single DSD data clock signal, DSDBCK (pin 17), along with two synchronous DSD data lines, DSDR (pin 15) and DSDL (pin 16). The data lines correspond to Right and Left channels, respectively. The DSD output rate is determined by the sampling mode settings for the device, discussed in the **Sampling Modes** section of this datasheet.

For DSD output data, the serial port is configured in Master mode, with the DSDBCK derived from the system clock input, SCKI. The DSDBCK is equivalent to the oversampling clock supplied to the delta-sigma modulators. The DSD data outputs, DSDR through DSDL, are synchronous to the DSDBCK. The clock and data lines are then connected to a data capture or processing device.

Figure 7 illustrates the DSD port timing for both the DSD output mode.

HIGH-PASS FILTER

A digital high-pass filter is available for removing the DC component of the digitized input signal. The filter is located at the output of the digital decimation filter, and is available only when using PCM output data formats. The high-pass

filter can be enabled or disabled for both the Left and Right channels using the HPFD input (pin 12). Driving the HPFD input low enables the high-pass filter. Driving the HPFD input high disables the high-pass filter.

The -3dB corner frequency for the high-pass filter scales with the output sampling rate, where $f_{-3dB} = f_S/48000$, where f_S is the output sampling rate.

CLIPPING FLAGS

The PCM4202 includes a clipping flag output for each channel. The outputs are designated CLIPL (pin 21) and CLIPR (pin 20), corresponding to the Left and Right channels, respectively. The clipping flags are only available when using PCM output data formats.

A clipping flag is forced high as soon as the digital output of the decimation filter exceeds the full-scale range for the corresponding channel. The clipping flag output is held high for a maximum of $(256 \times N) / f_S$ seconds, where $N = 128$ for Single Rate sampling mode, 256 for Dual Rate sampling mode, and 512 for Quad Rate sampling mode. If the decimation filter output does not exceed the full-scale range during the initial hold period, the output returns to a low state upon termination of the hold period.

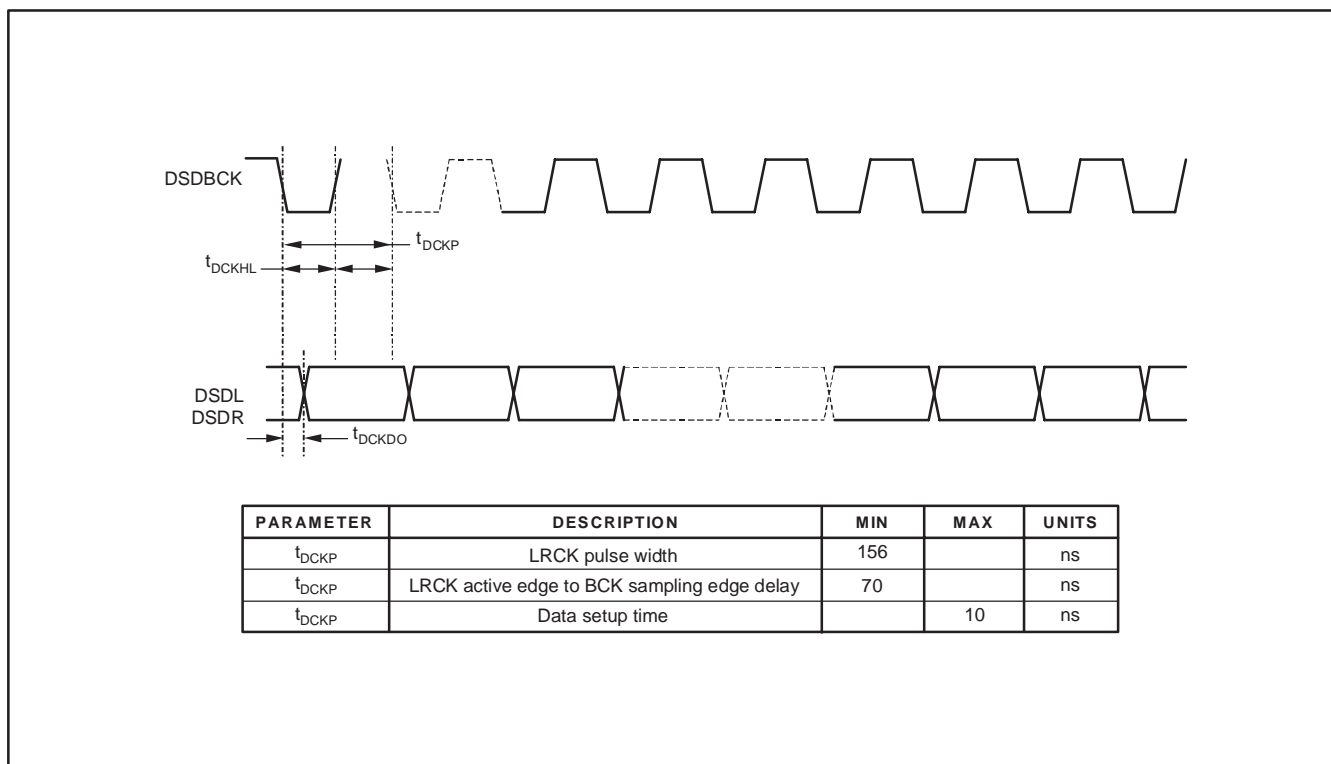

Figure 7. DSD Data Port Timing

RESET OPERATION

The PCM4202 includes two reset functions: power-on and externally controlled. This section describes the operation of each of these functions.

On power-up, the internal reset signal is forced low, forcing the PCM4202 into a reset state. The power-on reset circuit monitors the V_{DD} (pin 14) and V_{CC} (pin 22) power supplies. When the V_{DD} supply exceeds +2.0V ($\pm 400\text{mV}$) and the V_{CC} supply exceeds +4.0V ($\pm 400\text{mV}$), the internal reset signal is forced high. The PCM4202 then waits for the system clock input (SCKI) to become active. Once the system clock has been detected, the initialization sequence begins. The initialization sequence requires 1024 system clock periods for completion. During the initialization sequence, the ADC output data pins are

forced low. Once the initialization sequence is completed, the PCM4202 output is enabled. Figure 8 shows the power-on reset sequence timing.

The user may force a reset initialization sequence at any time while the system clock input is active by utilizing the $\overline{\text{RST}}$ input (pin 19). The $\overline{\text{RST}}$ input is active low, and requires a minimum low pulse width of 40ns. The low-to-high transition of the applied reset signal forces an initialization sequence to begin. As in the case of the power-on reset, the initialization sequence requires 1024 system clock periods for completion. Figure 9 illustrates the reset sequence initiated when using the $\overline{\text{RST}}$ input.

Figure 10 shows the state of the audio data outputs for the PCM4202 before, during and after the reset operations.

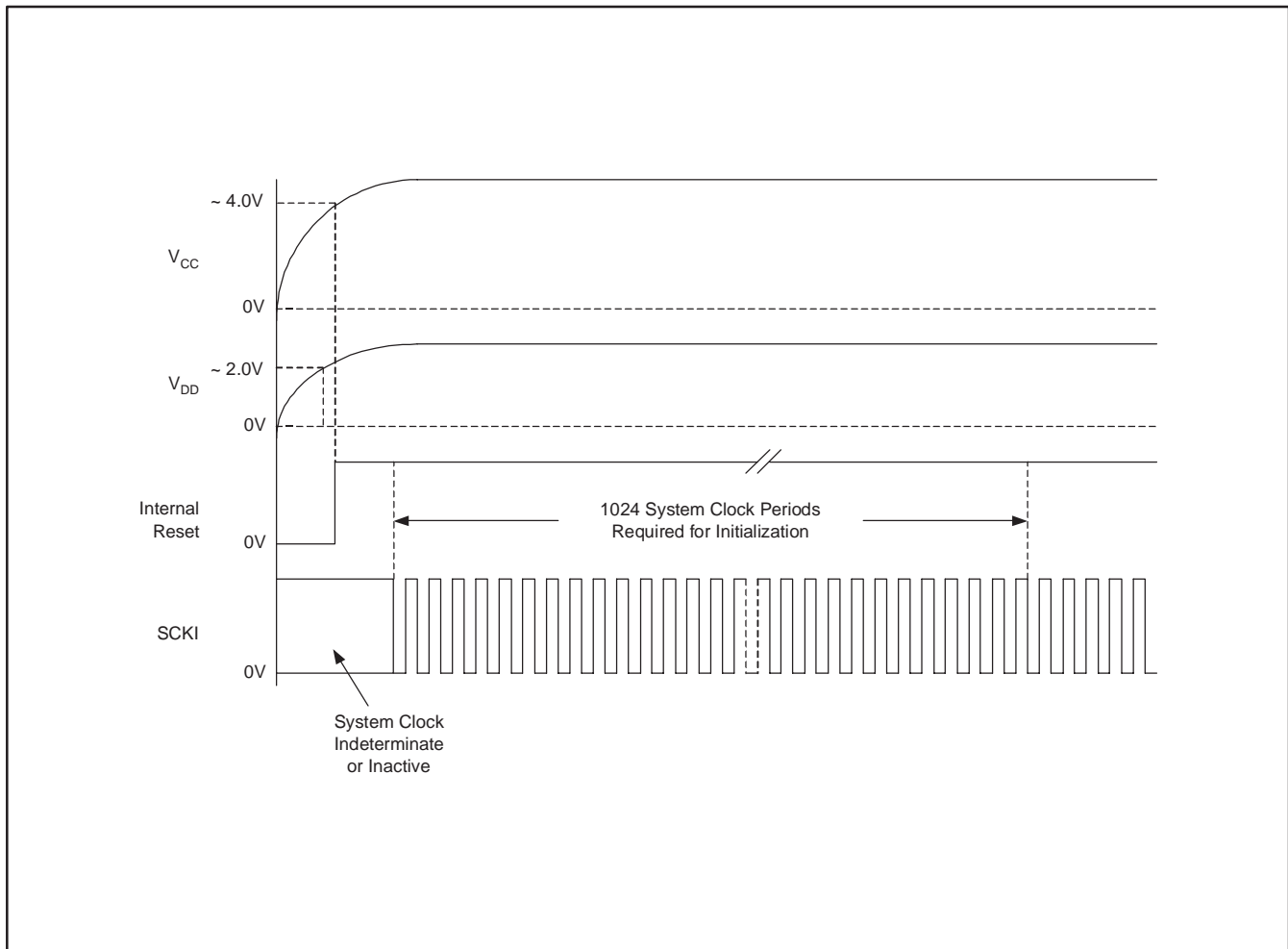

Figure 8. Power-On Reset Sequence

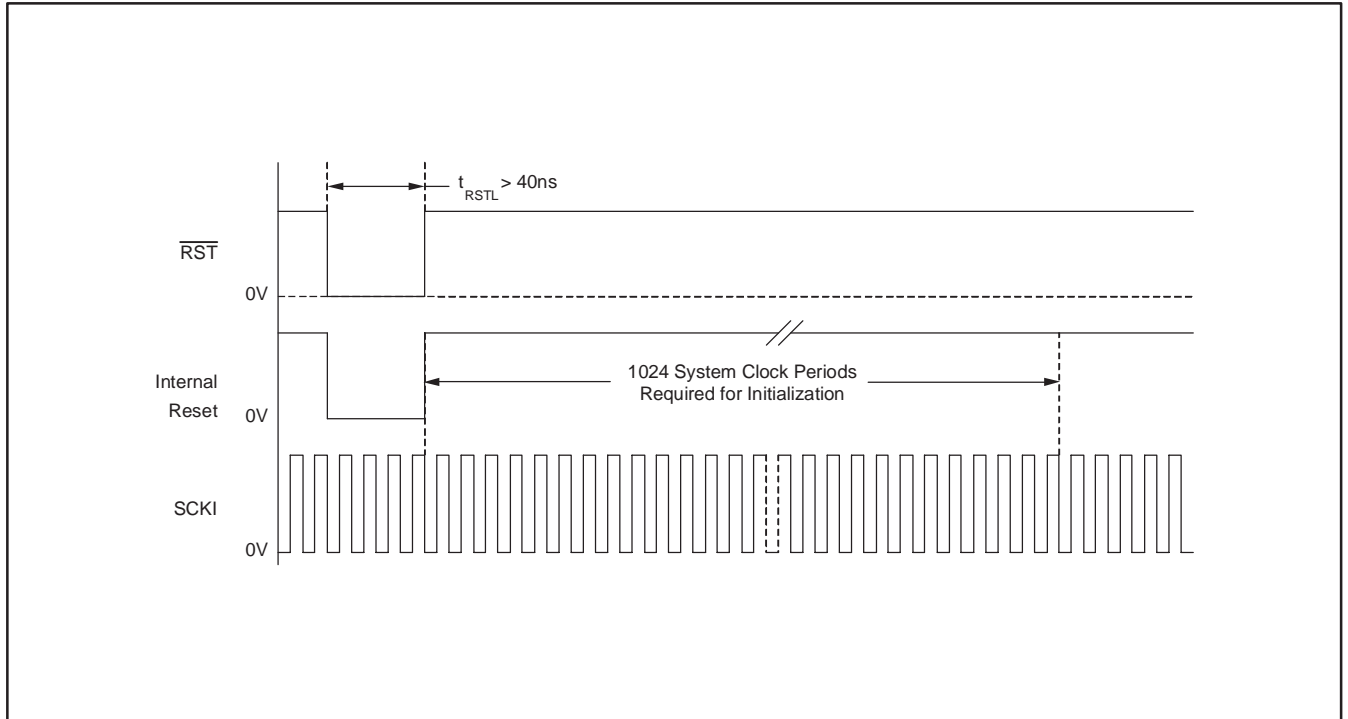

Figure 9. External Reset Sequence

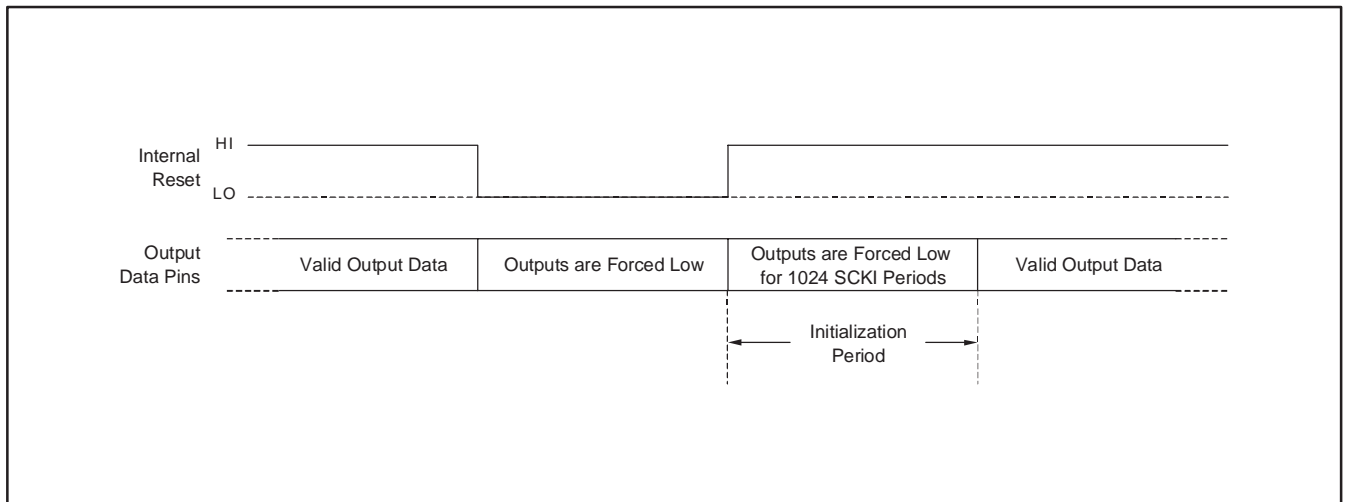

Figure 10. ADC Digital Output State for Reset Operations

POWER-DOWN OPERATION

The PCM4202 can be forced to a power-down state by applying a low level to the $\overline{\text{RST}}$ input (pin 19) for a minimum of 65,536 system clock cycles. In power-down mode, all internal clocks are stopped, and output data pins are forced low. The system clock may then be removed to conserve additional power. Before exiting power-down mode, the system and audio clocks should be restarted. Once the clocks are active, the $\overline{\text{RST}}$ input may be driven high, which initiates a reset initialization sequence. Figure 11 illustrates the state of the output data pins during before, during, and upon exiting the power-down state.

APPLICATIONS INFORMATION

A typical connection diagram for the PCM4202 is shown in Figure 12. Capacitors for power supply and reference bypassing are shown with recommended values. Bypass capacitors should be located as close as possible to the power supply and reference pins of the PCM4202. Due to its small size, the 0.1 μF capacitor can be located on the component (top) side of the board, while the larger 33 μF capacitor can be located on the solder (bottom) side of the board.

A single ground plane is utilized for the analog and digital ground connections. This approach ensures a low impedance connection between the analog and digital ground pins. The +5V analog and +3.3V digital power connections are provided from separate supplies.

Figure 13 illustrates an example input buffer circuit, designed for balanced differential input signals. This circuit is utilized on the PCM4202EVM evaluation board. The 2.7nF and 100pF capacitors shown at the output of the buffer should be located as close as possible to the analog input pins of the PCM4202. The buffer shown in Figure 13 can be easily made to function as a single ended to differential converter by simply grounding the (-) input terminal of the buffer circuit.

The input impedance for the V_{COMIN} pin of the OPA1632 is relatively low and will load down the V_{COML} or V_{COMR} outputs from the PCM4202. A voltage follower circuit is required to buffer these outputs, with a typical circuit configuration shown in Figure 14. An OPA227 is utilized as the buffer for the PCM4202EVM evaluation board. However, alternative op amps with comparable performance may be substituted.

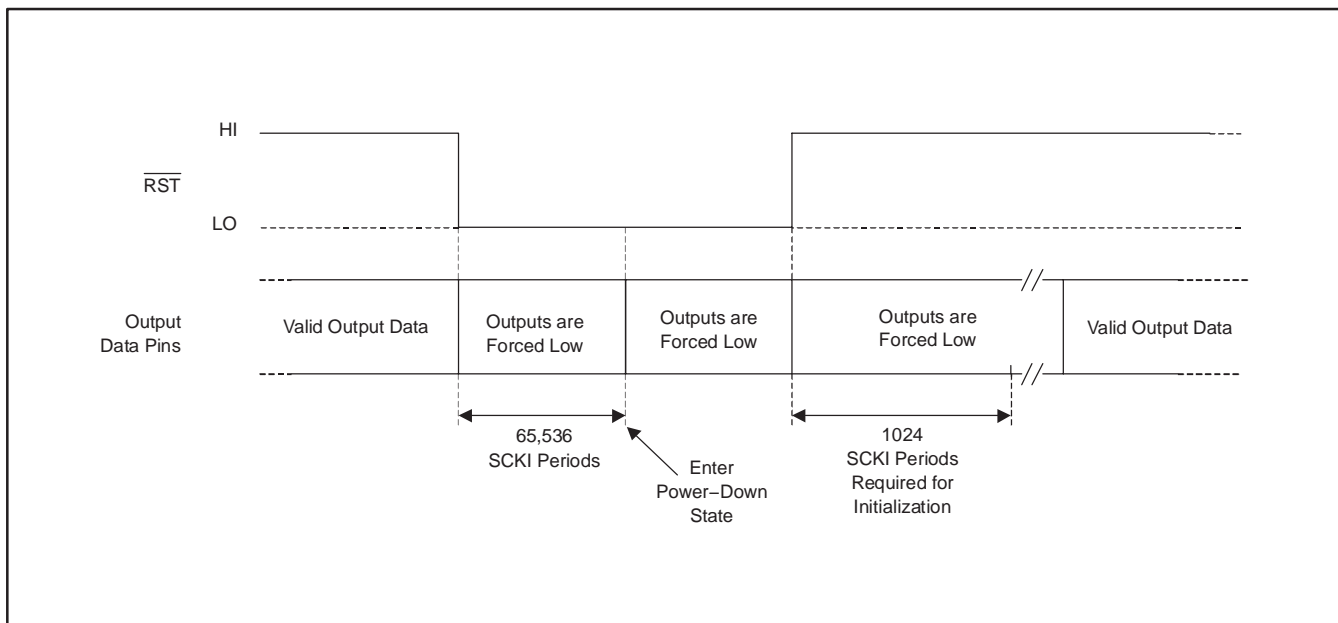

Figure 11. ADC Digital Output State for Power-Down Operations

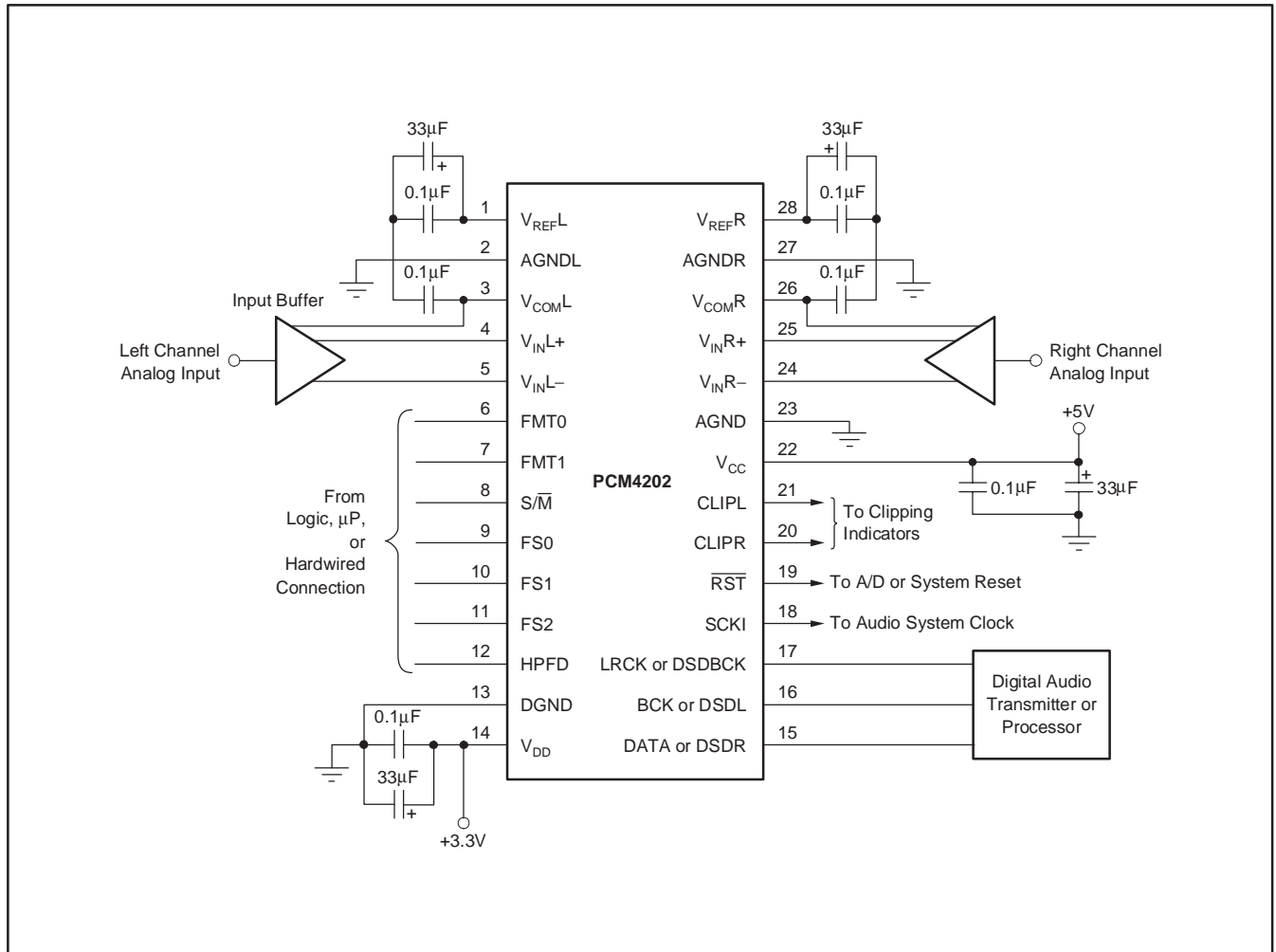

Figure 12. Typical Connection Diagram

COMPATIBILITY WITH THE PCM1804

Although the PCM4202 and PCM1804 are pin- and function-compatible, there are a few differences between the two devices that the designer should be aware of. These differences are noted here for clarity.

- The full-scale input of the PCM4202 is 6.0V_{PP} differential, while it is 5.0V_{PP} for the PCM1804. This is a result of the PCM4202 having an internal +3.0V voltage reference, and the PCM1804 having an internal +2.5V voltage reference.
- The PCM1804 includes +5V tolerant digital inputs. The PCM4202 does not include these because the digital inputs are designed for interfacing to +3.3V logic.
- The reset pin ($\overline{\text{RST}}$) pin of the PCM4202 has an internal pull-up resistor. For the PCM1804, this pin has an internal pull-down resistor.

- When operating in Master mode with Single Rate sampling selected, the audio serial port bit clock (BCK) is equal to $64f_s$ for the PCM1804, while the BCK rate is equal to $128f_s$ for the PCM4202.
- The following pins on the PCM4202 and PCM1804 have different names, but they perform the same functions.

TERMINAL NUMBER	PCM4202 TERMINAL NAME	PCM1804 TERMINAL NAME
9	FS0	OSR0
10	FS1	OSR1
11	FS2	OSR2
12	HPFD	BYPAS
20	CLIPR	OVFR
21	CL IPL	OVFL

PACKAGING INFORMATION

Orderable Device	Status (1)	Package Type	Package Drawing	Pins	Package Qty	Eco Plan (2)	Lead/Ball Finish (6)	MSL Peak Temp (3)	Op Temp (°C)	Device Marking (4/5)	Samples
PCM4202DB	ACTIVE	SSOP	DB	28	50	Green (RoHS & no Sb/Br)	CU NIPDAU	Level-2-260C-1 YEAR	-10 to 70	PCM4202	Samples
PCM4202DBR	ACTIVE	SSOP	DB	28	1000	Green (RoHS & no Sb/Br)	CU NIPDAU	Level-2-260C-1 YEAR	-10 to 70	PCM4202	Samples
PCM4202DBT	ACTIVE	SSOP	DB	28	250	Green (RoHS & no Sb/Br)	CU NIPDAU	Level-2-260C-1 YEAR	-10 to 70	PCM4202	Samples
PCM4202DBTG4	ACTIVE	SSOP	DB	28	250	Green (RoHS & no Sb/Br)	CU NIPDAU	Level-2-260C-1 YEAR	-10 to 70	PCM4202	Samples

(1) The marketing status values are defined as follows:

ACTIVE: Product device recommended for new designs.

LIFEBUY: TI has announced that the device will be discontinued, and a lifetime-buy period is in effect.

NRND: Not recommended for new designs. Device is in production to support existing customers, but TI does not recommend using this part in a new design.

PREVIEW: Device has been announced but is not in production. Samples may or may not be available.

OBSOLETE: TI has discontinued the production of the device.

(2) **RoHS:** TI defines "RoHS" to mean semiconductor products that are compliant with the current EU RoHS requirements for all 10 RoHS substances, including the requirement that RoHS substance do not exceed 0.1% by weight in homogeneous materials. Where designed to be soldered at high temperatures, "RoHS" products are suitable for use in specified lead-free processes. TI may reference these types of products as "Pb-Free".

RoHS Exempt: TI defines "RoHS Exempt" to mean products that contain lead but are compliant with EU RoHS pursuant to a specific EU RoHS exemption.

Green: TI defines "Green" to mean the content of Chlorine (Cl) and Bromine (Br) based flame retardants meet JS709B low halogen requirements of <=1000ppm threshold. Antimony trioxide based flame retardants must also meet the <=1000ppm threshold requirement.

(3) MSL, Peak Temp. - The Moisture Sensitivity Level rating according to the JEDEC industry standard classifications, and peak solder temperature.

(4) There may be additional marking, which relates to the logo, the lot trace code information, or the environmental category on the device.

(5) Multiple Device Markings will be inside parentheses. Only one Device Marking contained in parentheses and separated by a "-" will appear on a device. If a line is indented then it is a continuation of the previous line and the two combined represent the entire Device Marking for that device.

(6) Lead/Ball Finish - Orderable Devices may have multiple material finish options. Finish options are separated by a vertical ruled line. Lead/Ball Finish values may wrap to two lines if the finish value exceeds the maximum column width.

Important Information and Disclaimer: The information provided on this page represents TI's knowledge and belief as of the date that it is provided. TI bases its knowledge and belief on information provided by third parties, and makes no representation or warranty as to the accuracy of such information. Efforts are underway to better integrate information from third parties. TI has taken and

continues to take reasonable steps to provide representative and accurate information but may not have conducted destructive testing or chemical analysis on incoming materials and chemicals. TI and TI suppliers consider certain information to be proprietary, and thus CAS numbers and other limited information may not be available for release.

In no event shall TI's liability arising out of such information exceed the total purchase price of the TI part(s) at issue in this document sold by TI to Customer on an annual basis.

TAPE AND REEL INFORMATION



QUADRANT ASSIGNMENTS FOR PIN 1 ORIENTATION IN TAPE

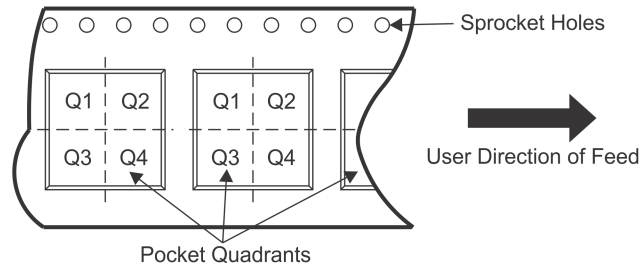

*All dimensions are nominal

Device	Package Type	Package Drawing	Pins	SPQ	Reel Diameter (mm)	Reel Width W1 (mm)	A0 (mm)	B0 (mm)	K0 (mm)	P1 (mm)	W (mm)	Pin1 Quadrant
PCM4202DBT	SSOP	DB	28	250	330.0	16.4	8.2	10.5	2.5	12.0	16.0	Q1

TAPE AND REEL BOX DIMENSIONS

*All dimensions are nominal

Device	Package Type	Package Drawing	Pins	SPQ	Length (mm)	Width (mm)	Height (mm)
PCM4202DBT	SSOP	DB	28	250	210.0	185.0	35.0

DB0028A



PACKAGE OUTLINE

SSOP - 2 mm max height

SMALL OUTLINE PACKAGE

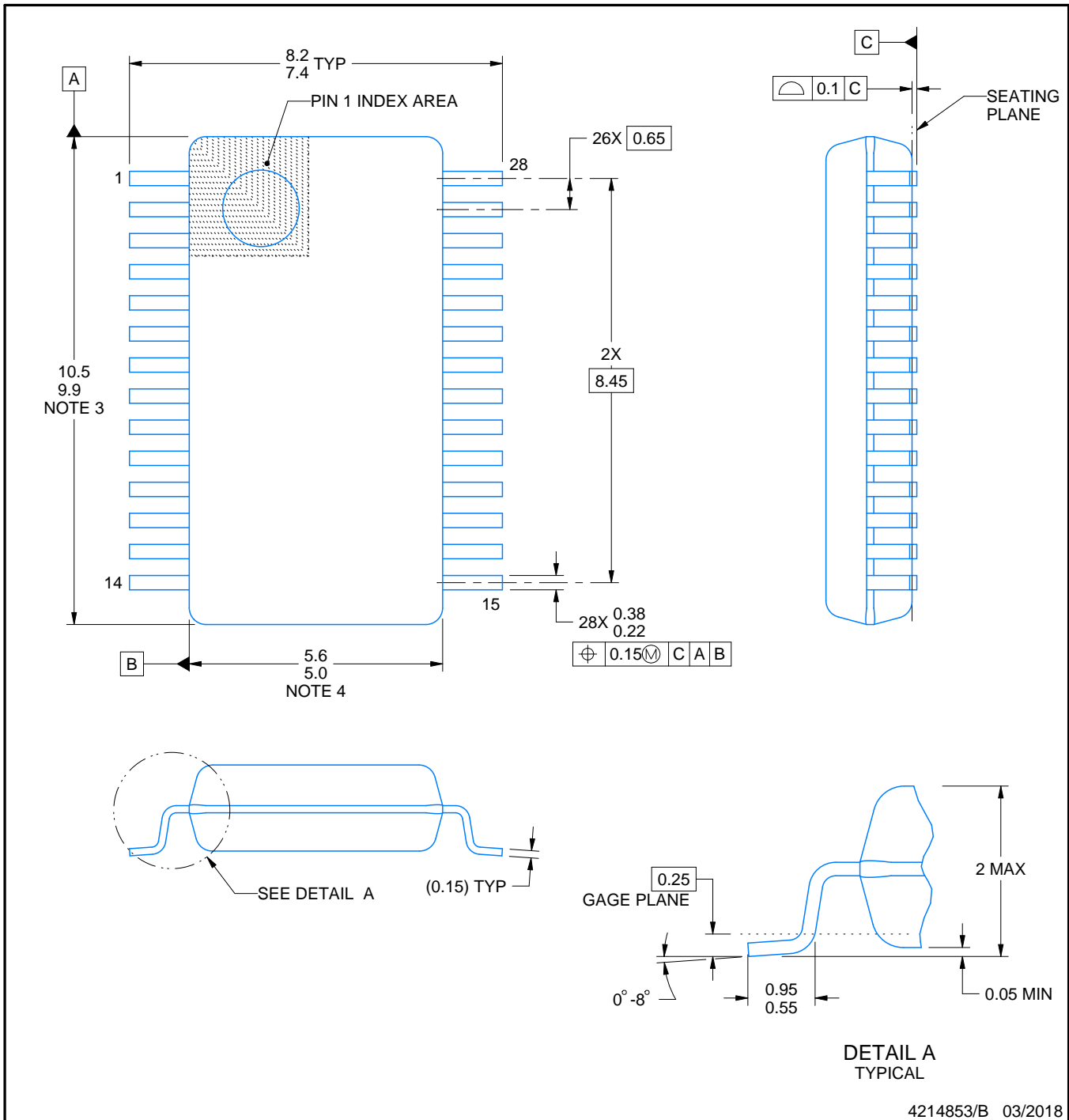

4214853/B 03/2018

NOTES:

1. All linear dimensions are in millimeters. Any dimensions in parenthesis are for reference only. Dimensioning and tolerancing per ASME Y14.5M.
2. This drawing is subject to change without notice.
3. This dimension does not include mold flash, protrusions, or gate burrs. Mold flash, protrusions, or gate burrs shall not exceed 0.15 mm per side.
4. This dimension does not include interlead flash. Interlead flash shall not exceed 0.25 mm per side.
5. Reference JEDEC registration MO-150.

EXAMPLE BOARD LAYOUT

DB0028A

SSOP - 2 mm max height

SMALL OUTLINE PACKAGE

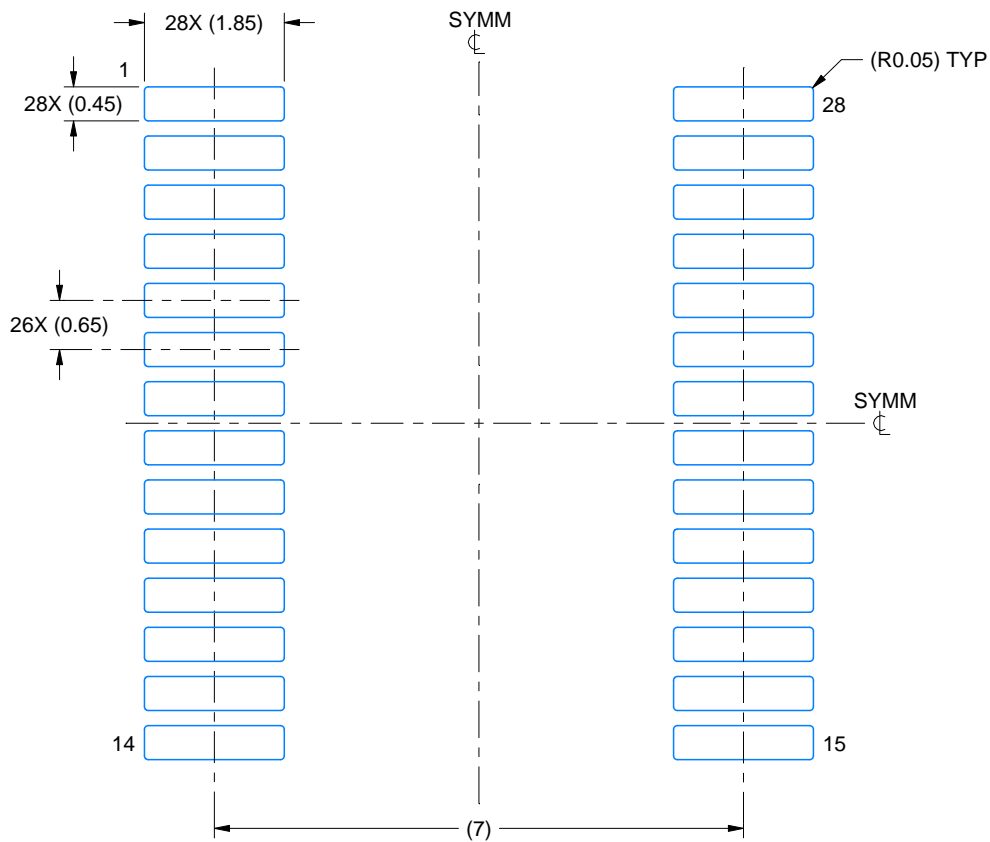

LAND PATTERN EXAMPLE
EXPOSED METAL SHOWN
SCALE: 10X

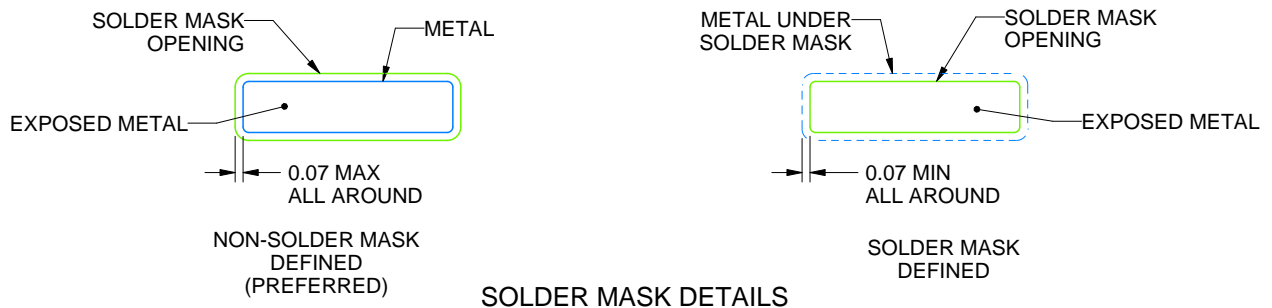

4214853/B 03/2018

NOTES: (continued)

- 6. Publication IPC-7351 may have alternate designs.
- 7. Solder mask tolerances between and around signal pads can vary based on board fabrication site.

EXAMPLE STENCIL DESIGN

DB0028A

SSOP - 2 mm max height

SMALL OUTLINE PACKAGE

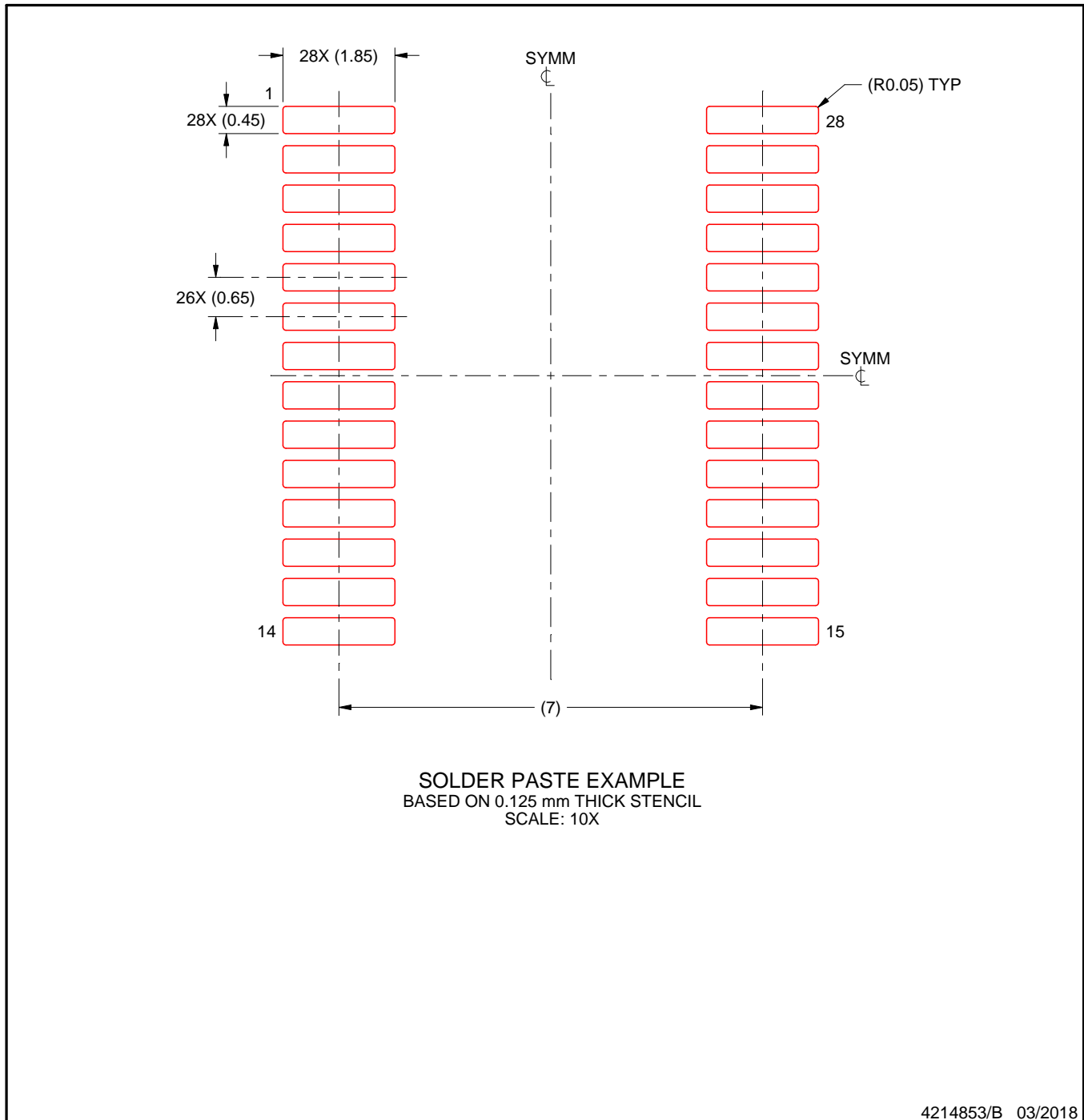

NOTES: (continued)

8. Laser cutting apertures with trapezoidal walls and rounded corners may offer better paste release. IPC-7525 may have alternate design recommendations.
9. Board assembly site may have different recommendations for stencil design.

IMPORTANT NOTICE

Texas Instruments Incorporated (TI) reserves the right to make corrections, enhancements, improvements and other changes to its semiconductor products and services per JESD46, latest issue, and to discontinue any product or service per JESD48, latest issue. Buyers should obtain the latest relevant information before placing orders and should verify that such information is current and complete.

TI's published terms of sale for semiconductor products (<http://www.ti.com/sc/docs/stdterms.htm>) apply to the sale of packaged integrated circuit products that TI has qualified and released to market. Additional terms may apply to the use or sale of other types of TI products and services.

Reproduction of significant portions of TI information in TI data sheets is permissible only if reproduction is without alteration and is accompanied by all associated warranties, conditions, limitations, and notices. TI is not responsible or liable for such reproduced documentation. Information of third parties may be subject to additional restrictions. Resale of TI products or services with statements different from or beyond the parameters stated by TI for that product or service voids all express and any implied warranties for the associated TI product or service and is an unfair and deceptive business practice. TI is not responsible or liable for any such statements.

Buyers and others who are developing systems that incorporate TI products (collectively, "Designers") understand and agree that Designers remain responsible for using their independent analysis, evaluation and judgment in designing their applications and that Designers have full and exclusive responsibility to assure the safety of Designers' applications and compliance of their applications (and of all TI products used in or for Designers' applications) with all applicable regulations, laws and other applicable requirements. Designer represents that, with respect to their applications, Designer has all the necessary expertise to create and implement safeguards that (1) anticipate dangerous consequences of failures, (2) monitor failures and their consequences, and (3) lessen the likelihood of failures that might cause harm and take appropriate actions. Designer agrees that prior to using or distributing any applications that include TI products, Designer will thoroughly test such applications and the functionality of such TI products as used in such applications.

TI's provision of technical, application or other design advice, quality characterization, reliability data or other services or information, including, but not limited to, reference designs and materials relating to evaluation modules, (collectively, "TI Resources") are intended to assist designers who are developing applications that incorporate TI products; by downloading, accessing or using TI Resources in any way, Designer (individually or, if Designer is acting on behalf of a company, Designer's company) agrees to use any particular TI Resource solely for this purpose and subject to the terms of this Notice.

TI's provision of TI Resources does not expand or otherwise alter TI's applicable published warranties or warranty disclaimers for TI products, and no additional obligations or liabilities arise from TI providing such TI Resources. TI reserves the right to make corrections, enhancements, improvements and other changes to its TI Resources. TI has not conducted any testing other than that specifically described in the published documentation for a particular TI Resource.

Designer is authorized to use, copy and modify any individual TI Resource only in connection with the development of applications that include the TI product(s) identified in such TI Resource. NO OTHER LICENSE, EXPRESS OR IMPLIED, BY ESTOPPEL OR OTHERWISE TO ANY OTHER TI INTELLECTUAL PROPERTY RIGHT, AND NO LICENSE TO ANY TECHNOLOGY OR INTELLECTUAL PROPERTY RIGHT OF TI OR ANY THIRD PARTY IS GRANTED HEREIN, including but not limited to any patent right, copyright, mask work right, or other intellectual property right relating to any combination, machine, or process in which TI products or services are used. Information regarding or referencing third-party products or services does not constitute a license to use such products or services, or a warranty or endorsement thereof. Use of TI Resources may require a license from a third party under the patents or other intellectual property of the third party, or a license from TI under the patents or other intellectual property of TI.

TI RESOURCES ARE PROVIDED "AS IS" AND WITH ALL FAULTS. TI DISCLAIMS ALL OTHER WARRANTIES OR REPRESENTATIONS, EXPRESS OR IMPLIED, REGARDING RESOURCES OR USE THEREOF, INCLUDING BUT NOT LIMITED TO ACCURACY OR COMPLETENESS, TITLE, ANY EPIDEMIC FAILURE WARRANTY AND ANY IMPLIED WARRANTIES OF MERCHANTABILITY, FITNESS FOR A PARTICULAR PURPOSE, AND NON-INFRINGEMENT OF ANY THIRD PARTY INTELLECTUAL PROPERTY RIGHTS. TI SHALL NOT BE LIABLE FOR AND SHALL NOT DEFEND OR INDEMNIFY DESIGNER AGAINST ANY CLAIM, INCLUDING BUT NOT LIMITED TO ANY INFRINGEMENT CLAIM THAT RELATES TO OR IS BASED ON ANY COMBINATION OF PRODUCTS EVEN IF DESCRIBED IN TI RESOURCES OR OTHERWISE. IN NO EVENT SHALL TI BE LIABLE FOR ANY ACTUAL, DIRECT, SPECIAL, COLLATERAL, INDIRECT, PUNITIVE, INCIDENTAL, CONSEQUENTIAL OR EXEMPLARY DAMAGES IN CONNECTION WITH OR ARISING OUT OF TI RESOURCES OR USE THEREOF, AND REGARDLESS OF WHETHER TI HAS BEEN ADVISED OF THE POSSIBILITY OF SUCH DAMAGES.

Unless TI has explicitly designated an individual product as meeting the requirements of a particular industry standard (e.g., ISO/TS 16949 and ISO 26262), TI is not responsible for any failure to meet such industry standard requirements.

Where TI specifically promotes products as facilitating functional safety or as compliant with industry functional safety standards, such products are intended to help enable customers to design and create their own applications that meet applicable functional safety standards and requirements. Using products in an application does not by itself establish any safety features in the application. Designers must ensure compliance with safety-related requirements and standards applicable to their applications. Designer may not use any TI products in life-critical medical equipment unless authorized officers of the parties have executed a special contract specifically governing such use. Life-critical medical equipment is medical equipment where failure of such equipment would cause serious bodily injury or death (e.g., life support, pacemakers, defibrillators, heart pumps, neurostimulators, and implantables). Such equipment includes, without limitation, all medical devices identified by the U.S. Food and Drug Administration as Class III devices and equivalent classifications outside the U.S.

TI may expressly designate certain products as completing a particular qualification (e.g., Q100, Military Grade, or Enhanced Product). Designers agree that it has the necessary expertise to select the product with the appropriate qualification designation for their applications and that proper product selection is at Designers' own risk. Designers are solely responsible for compliance with all legal and regulatory requirements in connection with such selection.

Designer will fully indemnify TI and its representatives against any damages, costs, losses, and/or liabilities arising out of Designer's non-compliance with the terms and provisions of this Notice.