

Surface Mount TRANSZORB® Transient Voltage Suppressors

eSMP® Series

SMP (DO-220AA)

Anode Cathode

DESIGN SUPPORT TOOLS
[click logo to get started](#)
3D
Models
Available

PRIMARY CHARACTERISTICS	
V _{BR} uni-directional	4.10 V to 44.2 V
V _{WM}	3.3 V to 36 V
P _{PPM}	400 W
I _{FSM}	40 A
T _J max.	150 °C
Polarity	Uni-directional
Package	SMP (DO-220AA)

FEATURES

- Very low profile - typical height of 1.0 mm
- Ideal for automated placement
- Available in uni-directional
- 400 W peak pulse power capability with a 10/1000 µs waveform
- Excellent clamping capability
- Very fast response time
- Low incremental surge resistance
- Meets MSL level 1, per J-STD-020, LF maximum peak of 260 °C
- Material categorization: for definitions of compliance please see www.vishay.com/doc?99912

RoHS
COMPLIANT
HALOGEN
FREE
TYPICAL APPLICATIONS

Use in sensitive electronics protection against voltage transients induced by inductive load switching and lighting on ICs, MOSFET, signal lines of sensor units for consumer, computer, industrial, and telecommunication.

MECHANICAL DATA
Case: SMP (DO-220AA)

Molding compound meets UL 94 V-0 flammability rating Base P/N-M3 - halogen-free, RoHS-compliant, and industrial grade

Terminals: matte tin plated leads, solderable per J-STD-002 and JESD 22-B102

M3 suffix meets JESD 201 class 2 whisker test

Polarity: color band denotes cathode end

MAXIMUM RATINGS (T _A = 25 °C unless otherwise noted)			
PARAMETER	SYMBOL	VALUE	UNIT
Peak pulse power dissipation with a 10/1000 µs waveform (fig. 1) ⁽¹⁾⁽²⁾	P _{PPM}	400	W
Peak pulse current with a 10/1000 µs waveform ⁽¹⁾	I _{PPM}	See table next page	A
Peak forward surge current 10 ms single half sine-wave ⁽²⁾	I _{FSM}	40	A
Maximum instantaneous forward voltage at 25 A ⁽³⁾	V _F	2.5	V
Operating junction and storage temperature range	T _J , T _{STG}	-55 to +150	°C

Notes

⁽¹⁾ Non-repetitive current pulse, per fig. 3 and derated above T_A = 25 °C per fig. 2

⁽²⁾ Mounted on 0.2" x 0.2" (5.0 mm x 5.0 mm) copper pads to each terminal

⁽³⁾ Pulse test: 300 µs pulse width, 1 % duty cycle



ELECTRICAL CHARACTERISTICS ($T_A = 25\text{ }^\circ\text{C}$ unless otherwise noted)								
DEVICE TYPE	DEVICE MARKING CODE	BREAKDOWN VOLTAGE V_{BR} AT I_T ⁽¹⁾ (V)		TEST CURRENT I_T (mA)	STAND-OFF VOLTAGE V_{WM} (V)	MAXIMUM REVERSE LEAKAGE AT V_{WM} I_D (μA) ⁽³⁾	MAXIMUM PEAK PULSE SURGE CURRENT I_{PPM} (A) ⁽²⁾	MAXIMUM CLAMPING VOLTAGE AT I_{PPM} V_C (V)
		MIN.	MAX.					
SMP3V3	AC	4.10	5.10	1.0	3.3	200	54.8	7.3
SMP5.0A	AE	6.40	7.07	10	5.0	150	43.5	9.2
SMP6.0A	AG	6.67	7.37	10	6.0	600	38.8	10.3
SMP6.5A	AK	7.22	7.98	10	6.5	100	35.7	11.2
SMP7.0A	AM	7.78	8.60	10	7.0	50	33.3	12.0
SMP7.5A	AN	8.33	9.21	1.0	7.5	50	31.0	12.9
SMP8.0A	AR	8.89	9.83	1.0	8.0	20	29.4	13.6
SMP11A	AZ	12.2	13.5	1.0	11	1.0	22.0	18.2
SMP12A	BE	13.3	14.7	1.0	12	1.0	20.1	19.9
SMP13A	BG	14.4	15.9	1.0	13	1.0	18.6	21.5
SMP14A	BK	15.6	17.2	1.0	14	1.0	17.2	23.2
SMP15A	BM	16.7	18.5	1.0	15	1.0	16.4	24.4
SMP16A	BP	17.8	19.7	1.0	16	1.0	15.4	26.0
SMP17A	BR	18.9	20.9	1.0	17	1.0	14.5	27.6
SMP18A	BT	20.0	22.1	1.0	18	1.0	13.7	29.2
SMP20A	BV	22.2	24.5	1.0	20	1.0	12.3	32.4
SMP22A	BX	24.4	26.9	1.0	22	1.0	11.3	35.5
SMP24A	BZ	26.7	29.5	1.0	24	1.0	10.3	38.9
SMP26A	CE	28.9	31.9	1.0	26	1.0	9.5	42.1
SMP28A	CG	31.1	34.4	1.0	28	1.0	8.8	45.4
SMP30A	CK	33.3	36.8	1.0	30	1.0	8.3	48.4
SMP33A	CM	36.7	40.6	1.0	33	1.0	7.5	53.3
SMP36A	CP	40.0	44.2	1.0	36	1.0	6.9	58.1

Notes

- (1) V_{BR} measured after I_T applied for 300 μs , I_T = square wave pulse or equivalent
(2) Surge current waveform per fig. 3 and derate per fig. 2
(3) All terms and symbols are consistent with ANSI/IEEE C62.35

THERMAL CHARACTERISTICS ($T_A = 25\text{ }^\circ\text{C}$ unless otherwise noted)			
PARAMETER	SYMBOL	LIMIT	UNIT
Typical thermal resistance, junction to lead ⁽¹⁾	$R_{\theta JL}$	50	$^\circ\text{C/W}$
Typical thermal resistance, junction to ambient ⁽²⁾	$R_{\theta JA}$	250	$^\circ\text{C/W}$

Notes

- (1) Mounted on PCB with 5.0 mm x 5.0 mm copper pad areas attached to each terminal
(2) Mounted on minimum recommended pad layout

ORDERING INFORMATION (Example)				
PREFERRED P/N	UNIT WEIGHT (g)	PREFERRED PACKAGE CODE	BASE QUANTITY	DELIVERY MODE
SMP3V3-M3/84A	0.024	84A	3000	7" diameter plastic tape and reel
SMP3V3-M3/85A	0.024	85A	10 000	13" diameter plastic tape and reel
SMP11A-M3/84A	0.024	84A	3000	7" diameter plastic tape and reel
SMP11A-M3/85A	0.024	85A	10 000	13" diameter plastic tape and reel



RATINGS AND CHARACTERISTICS CURVES ($T_A = 25\text{ }^\circ\text{C}$ unless otherwise noted)

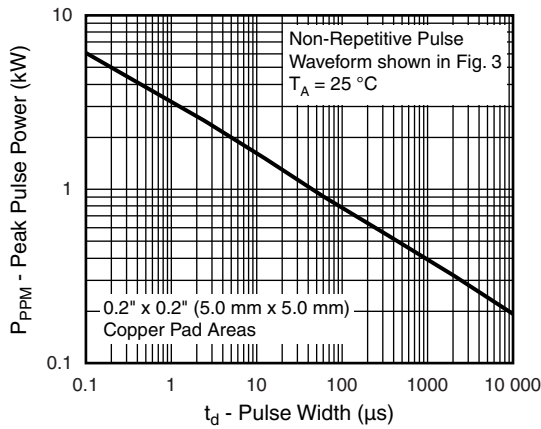

Fig. 1 - Peak Pulse Power Rating Curve

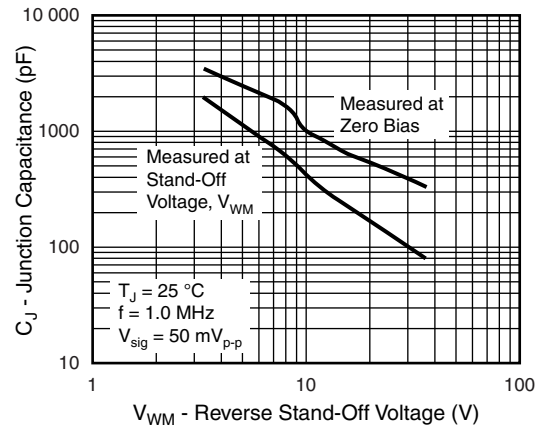

Fig. 4 - Typical Junction Capacitance

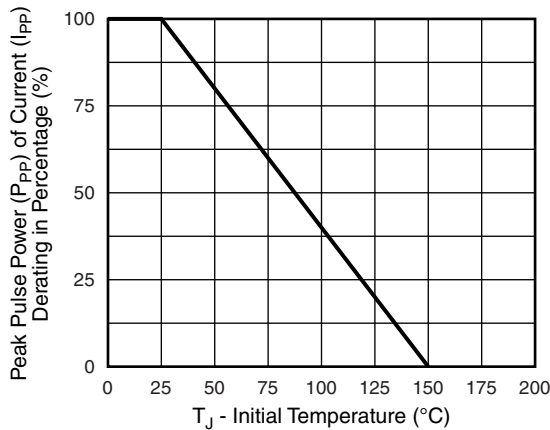

Fig. 2 - Pulse Derating Curve

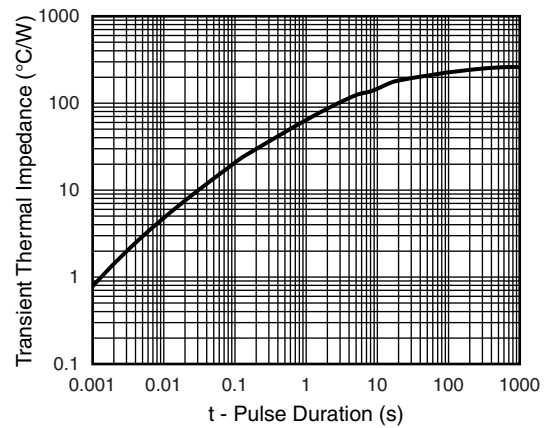

Fig. 5 - Typical Transient Thermal Impedance

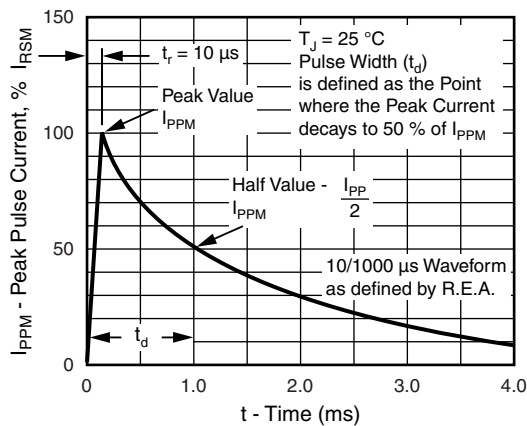
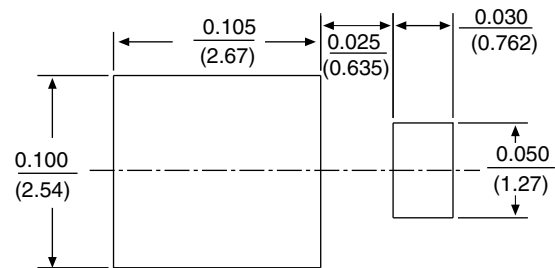
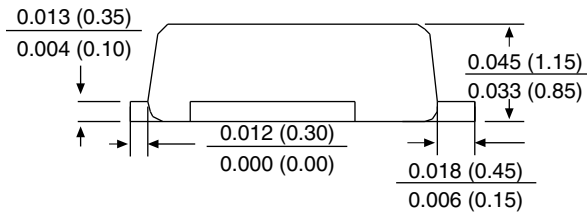
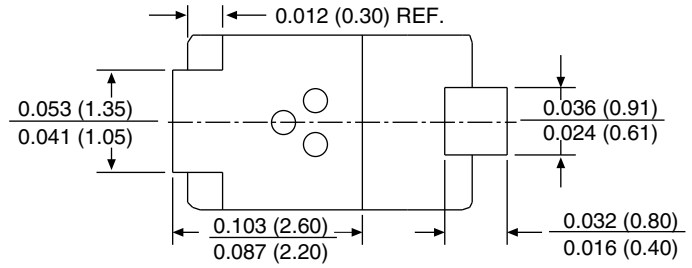
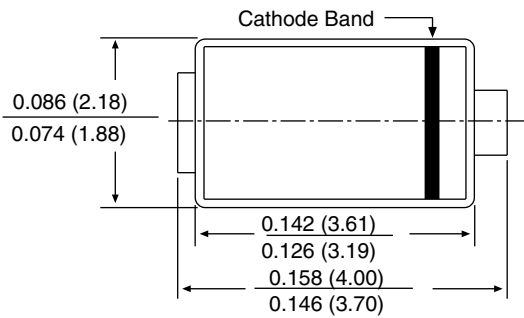

Fig. 3 - Pulse Waveform



PACKAGE OUTLINE DIMENSIONS in inches (millimeters)

SMP (DO-220AA)





Disclaimer

ALL PRODUCT, PRODUCT SPECIFICATIONS AND DATA ARE SUBJECT TO CHANGE WITHOUT NOTICE TO IMPROVE RELIABILITY, FUNCTION OR DESIGN OR OTHERWISE.

Vishay Intertechnology, Inc., its affiliates, agents, and employees, and all persons acting on its or their behalf (collectively, "Vishay"), disclaim any and all liability for any errors, inaccuracies or incompleteness contained in any datasheet or in any other disclosure relating to any product.

Vishay makes no warranty, representation or guarantee regarding the suitability of the products for any particular purpose or the continuing production of any product. To the maximum extent permitted by applicable law, Vishay disclaims (i) any and all liability arising out of the application or use of any product, (ii) any and all liability, including without limitation special, consequential or incidental damages, and (iii) any and all implied warranties, including warranties of fitness for particular purpose, non-infringement and merchantability.

Statements regarding the suitability of products for certain types of applications are based on Vishay's knowledge of typical requirements that are often placed on Vishay products in generic applications. Such statements are not binding statements about the suitability of products for a particular application. It is the customer's responsibility to validate that a particular product with the properties described in the product specification is suitable for use in a particular application. Parameters provided in datasheets and / or specifications may vary in different applications and performance may vary over time. All operating parameters, including typical parameters, must be validated for each customer application by the customer's technical experts. Product specifications do not expand or otherwise modify Vishay's terms and conditions of purchase, including but not limited to the warranty expressed therein.

Except as expressly indicated in writing, Vishay products are not designed for use in medical, life-saving, or life-sustaining applications or for any other application in which the failure of the Vishay product could result in personal injury or death. Customers using or selling Vishay products not expressly indicated for use in such applications do so at their own risk. Please contact authorized Vishay personnel to obtain written terms and conditions regarding products designed for such applications.

No license, express or implied, by estoppel or otherwise, to any intellectual property rights is granted by this document or by any conduct of Vishay. Product names and markings noted herein may be trademarks of their respective owners.