

FEATURES:

- UL Recognized
- .100" (2.54mm) Contact Spacing x .140" (3.56mm) Row Spacing
- Accepts .062" (1.57mm) Nominal Thickness P.C. Board
- Low Profile Insulator Body, .437" (11.10mm)
- Contact Termination Options include P.C. Tail, Wire Hole and Extender Board Bends
- Single or Dual Row Configurations
- Variety of Mounting Options
- Accepts between Contact and In-Contact Polarizing Keys
- RoHS Compliant

SPECIFICATIONS:

Insulator Material	UL 94V-0 Thermoplastic Polyester . DAP Material is available upon request
Contact Material	Copper Alloy
Contact Plating	Gold Plating on mating area and Tin Plating on tails with Nickel underplating all over
Current Rating	3 Amperes
Contact Resistance	10 milliohms maximum
Dielectric Withstanding Voltage	1200 VAC rms at sea level between adjacent contacts
Insulation Resistance	5000 Megohms minimum Insulation Resistance: 5000 Megohms minimum
Operating Temperature	-40°C to +105°C
Insertion Force	16oz (4.45N) maximum per contact pair when tested with .070" (1.78mm) thick gauge
Withdrawal Force	1oz (0.28N) minimum per contact pair when tested with .054" (1.37mm) thick gauge

EXAMPLE PART NUMBER 341-062-520-202

Series _____
 Total Number of Contacts _____
 Contact Code _____
 Contact Rows _____
 Mounting Options _____

Contact Rows:

- 1
- 2

Description

- Single Row
- Dual Row

Series:

- 341
- 391

Insulator Color

- Green
- Black

Total Number of Contacts:

- 005, 006, 060
- 010, 012, 120

Contact Rows

- Single Row
- Dual Row

Mounting Options:

- 01
- 02
- 03
- 04
- 07
- 08

Description

- No Mounting Lug
- ∅.128" (∅3.25mm) Mounting Holes
- ∅.116" (∅2.95mm) I.D. Floating Eyelets
- ∅.156" (∅3.96mm) Mounting Holes
- M3-0.5 Metric Threaded Inserts
- #4-40 Unified Threaded Inserts

Contact Code Description & Tail Size Tail Length "G"

Contact Code	Description & Tail Size	Tail Length "G"
500	Wire Hole .050 x .013 (1.27 x 0.33)	.220 (5.59)
520	P.C. Tail .025 x .013 (0.64 x 0.33)	.125 (3.18)
521	P.C. Tail .025 x .013 (0.64 x 0.33)	.260 (6.60)
522	P.C. Tail .025 x .013 (0.64 x 0.33)	.375 (9.53)
524	P.C. Tail .025 x .013 (0.64 x 0.33)	.100 (2.54)
555	Extender Board Bend(Code 500 Contacts)	
556	Extender Board Bend(Code 521 Contacts)	
560	Extender Board Bend(Code 522 Contacts)	

Ordering Code Notes:

- 1) All connector sizes up to 60 contacts single row / 120 contacts dual row are available upon request.
- 2) The 500 contact code is only available in the 341 series. Green polyphenylene sulphide insulator material will be supplied.
- 3) For details of the extender board bends refer to next pages.
- 4) For details of the mounting options refer to next pages.

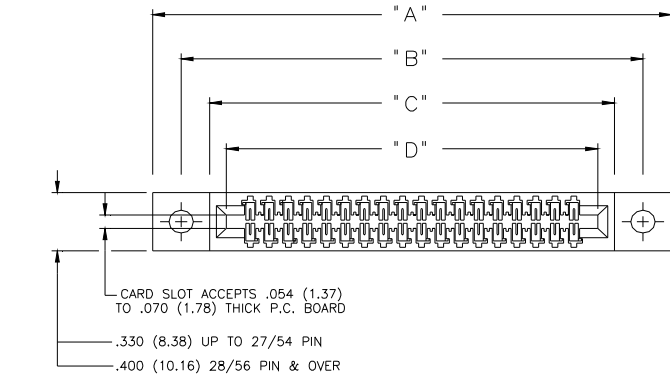

IN-CONTACT
POLARIZING KEY
P/N 321-240-328

BETWEEN CONTACT
POLARIZING KEY
P/N 341-240-318

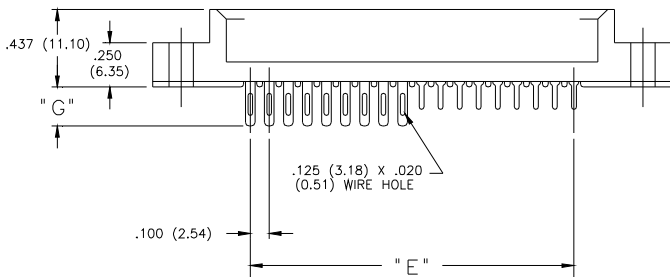
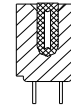

SECTION THROUGH
CONTACT POSITION

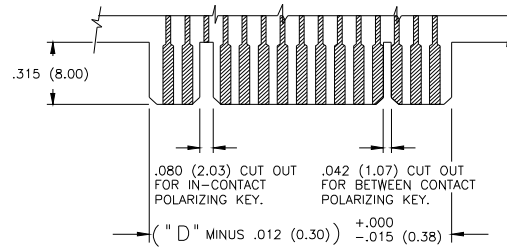
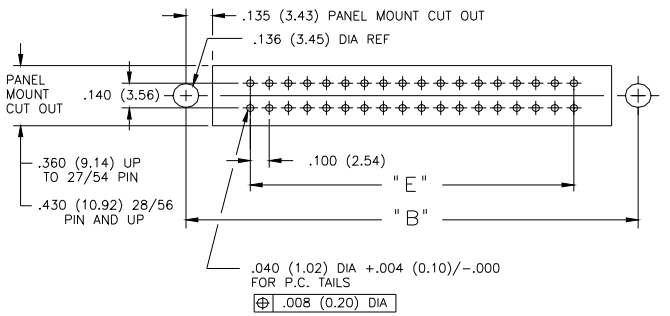
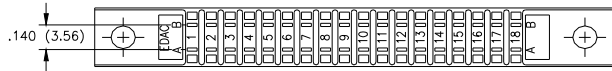
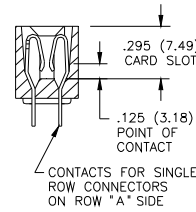

CONNECTOR MOUNTING PATTERN

RECOMMENDED DAUGHTER BOARD

NUMBER OF CONTACTS		"A"		"B"		"C"		"D"		"D"	
SINGLE	DOUBLE	INCH	MM	INCH	MM	INCH	MM	INCH	MM	INCH	MM
5	10	1.375	(34.93)	1.075	(27.31)	0.775	(19.69)	0.600	(15.24)	0.400	(10.16)
6	12	1.475	(37.47)	1.175	(29.85)	0.875	(22.23)	0.700	(17.78)	0.500	(12.7)
10	20	1.875	(47.63)	1.575	(40.01)	1.275	(32.39)	1.100	(27.94)	0.900	(22.86)
15	30	2.375	(60.33)	2.075	(52.71)	1.775	(45.09)	1.600	(40.64)	1.400	(35.56)
18	36	2.675	(67.95)	2.375	(60.33)	2.075	(52.71)	1.900	(48.26)	1.700	(43.18)
22	44	3.075	(78.11)	2.775	(70.49)	2.475	(62.87)	2.300	(58.42)	2.100	(53.34)
25	50	3.375	(85.73)	3.075	(78.11)	2.775	(70.49)	2.600	(66.04)	2.400	(60.96)
28	56	3.675	(93.35)	3.375	(85.73)	3.075	(78.11)	2.900	(73.66)	2.700	(68.58)
30	60	3.875	(98.43)	3.575	(90.81)	3.275	(83.19)	3.100	(78.74)	2.900	(73.66)
36	72	4.475	(113.67)	4.175	(106.05)	3.875	(98.43)	3.700	(93.98)	3.500	(88.9)
40	80	4.875	(123.83)	4.575	(116.21)	4.275	(108.59)	4.100	(104.14)	3.900	(99.06)
43	86	5.175	(131.45)	4.875	(123.83)	4.575	(116.21)	4.400	(111.76)	4.200	(106.68)
50	100	5.875	(149.23)	5.575	(141.61)	5.275	(133.99)	5.100	(129.54)	4.900	(124.46)
60	120	6.875	(174.63)	6.575	(167.01)	6.275	(159.39)	6.100	(154.94)	5.900	(149.86)

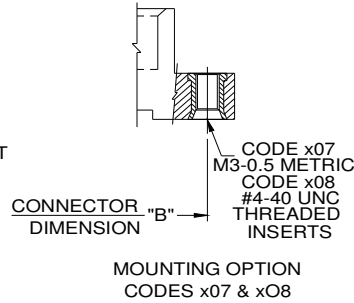
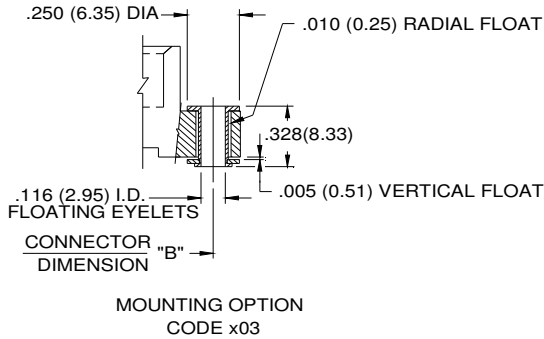
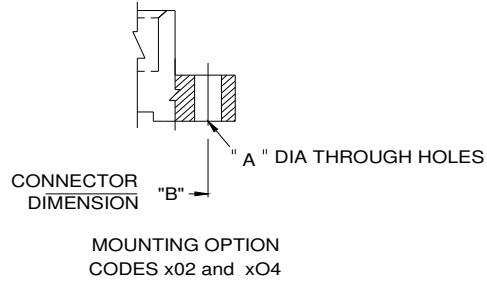
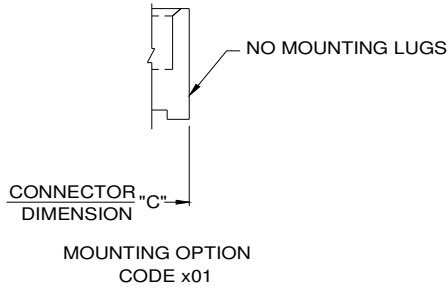

CODE X02 AND X04- THROUGH MTG. HOLES		
	CODE X02	CODE X04
"A" DIA.	0.128(3.25)	0.156(3.96)
CODE X07 AND X08- THREADED INSERTS		
	CODE X07	CODE X08
INSERT	M3-0.5(METRIC)	#4-40 UNC

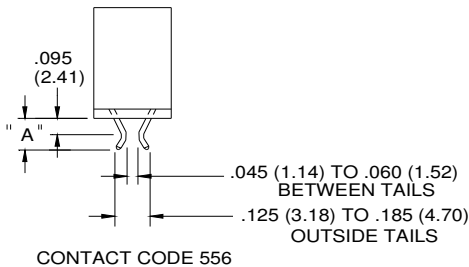
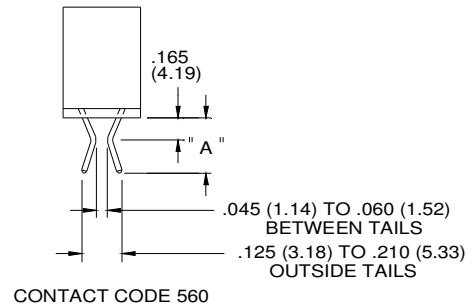
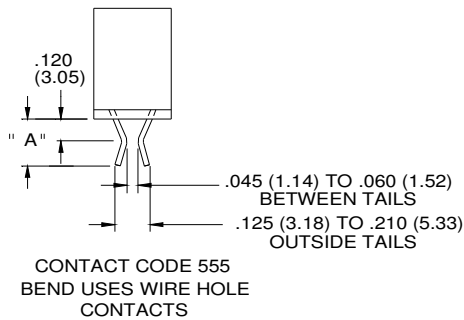

MTG. OPTION	A
555	0.205(5.21)
556	0.235(5.97)
560	0.365(9.27)

Mouser Electronics

Authorized Distributor

Click to View Pricing, Inventory, Delivery & Lifecycle Information:

EDAC:

[341-012-500-201](#) [341-012-500-202](#) [341-012-500-204](#) [341-012-520-204](#) [341-012-521-201](#) [341-012-521-202](#) [341-012-521-204](#) [341-012-522-201](#) [341-012-522-202](#) [341-012-522-204](#) [341-020-500-201](#) [341-020-500-204](#) [341-020-520-201](#) [341-020-520-204](#) [341-020-521-201](#) [341-020-521-202](#) [341-020-521-204](#) [341-020-522-201](#) [341-020-522-202](#) [341-020-522-204](#) [341-026-500-201](#) [341-026-500-202](#) [341-026-500-204](#) [341-026-520-201](#) [341-026-520-202](#) [341-026-520-204](#) [341-026-521-201](#) [341-026-521-202](#) [341-026-521-204](#) [341-026-522-201](#) [341-026-522-202](#) [341-026-522-204](#) [341-030-500-201](#) [341-030-500-202](#) [341-030-500-204](#) [341-030-520-201](#) [341-030-520-204](#) [341-030-521-201](#) [341-030-521-202](#) [341-030-521-204](#) [341-030-522-201](#) [341-030-522-202](#) [341-030-522-204](#) [341-036-500-201](#) [341-036-500-202](#) [341-036-500-204](#) [341-036-520-201](#) [341-036-520-202](#) [341-036-520-204](#) [341-036-521-201](#) [341-036-521-202](#) [341-036-521-204](#) [341-036-522-201](#) [341-036-522-202](#) [341-036-522-204](#) [341-040-500-201](#) [341-040-500-202](#) [341-040-500-204](#) [341-040-520-201](#) [341-040-520-202](#) [341-040-520-204](#) [341-040-521-201](#) [341-040-521-202](#) [341-040-521-204](#) [341-040-522-201](#) [341-040-522-202](#) [341-040-522-204](#) [341-044-500-201](#) [341-044-500-202](#) [341-044-500-204](#) [341-044-520-201](#) [341-044-520-202](#) [341-044-520-204](#) [341-044-521-201](#) [341-044-521-202](#) [341-044-521-204](#) [341-044-522-201](#) [341-044-522-202](#) [341-044-522-204](#) [341-050-500-201](#) [341-050-500-202](#) [341-050-500-204](#) [341-050-520-201](#) [341-050-520-202](#) [341-050-520-204](#) [341-050-521-201](#) [341-050-521-202](#) [341-050-521-204](#) [341-050-522-201](#) [341-050-522-202](#) [341-050-522-204](#) [341-056-500-201](#) [341-056-500-202](#) [341-056-500-204](#) [341-056-520-201](#) [341-056-520-202](#) [341-056-520-204](#) [341-056-521-201](#) [341-056-521-202](#) [341-056-521-204](#) [341-056-522-201](#) [341-056-522-202](#)