

FEATURES

- 45MHz Gain-Bandwidth
- 400V/ μ s Slew Rate
- Unity-Gain Stable
- 7V/mV DC Gain, $R_L = 500\Omega$
- 3mV Maximum Input Offset Voltage
- ± 12 V Minimum Output Swing into 500Ω
- Wide Supply Range: ± 2.5 V to ± 15 V
- 7mA Supply Current per Amplifier
- 90ns Settling Time to 0.1%, 10V Step
- Drives All Capacitive Loads

APPLICATIONS

- Wideband Amplifiers
- Buffers
- Active Filters
- Video and RF Amplification
- Cable Drivers
- Data Acquisition Systems

DESCRIPTION

The LT1208/LT1209 are dual and quad very high speed operational amplifiers with excellent DC performance. The LT1208/LT1209 feature reduced input offset voltage and higher DC gain than devices with comparable bandwidth and slew rate. Each amplifier is a single gain stage with outstanding settling characteristics. The fast settling time makes the circuit an ideal choice for data acquisition systems. Each output is capable of driving a 500Ω load to ± 12 V with ± 15 V supplies and a 150Ω load to ± 3 V on ± 5 V supplies. The amplifiers are also capable of driving large capacitive loads which make them useful in buffer or cable driver applications.

The LT1208/LT1209 are members of a family of fast, high performance amplifiers that employ Linear Technology Corporation's advanced bipolar complementary processing.

TYPICAL APPLICATION

1MHz, 4th Order Butterworth Filter

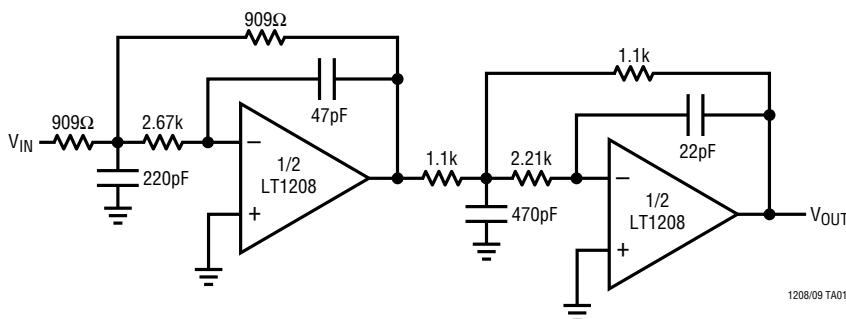

Inverter Pulse Response

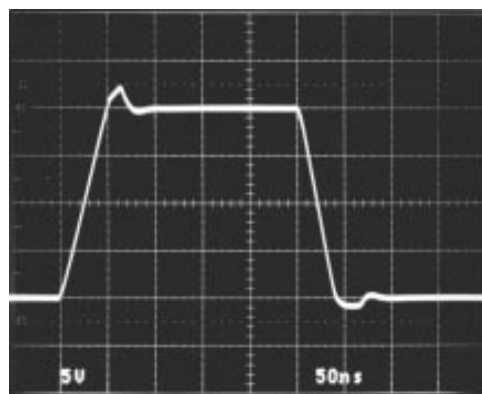

1208/09 TA02

LT1208/LT1209

ABSOLUTE MAXIMUM RATINGS

Total Supply Voltage (V^+ to V^-)	36V	Maximum Junction Temperature	
Differential Input Voltage	$\pm 6V$	Plastic Package	150°C
Input Voltage	$\pm V_S$	Storage Temperature Range	-65°C to 150°C
Output Short-Circuit Duration (Note 1)	Indefinite	Lead Temperature (Soldering, 10 sec)	300°C
Operating Temperature Range			
LT1208C/LT1209C	-40°C to 85°C		

PACKAGE/ORDER INFORMATION

<p>N8 PACKAGE 8-LEAD PLASTIC DIP $T_{JMAX} = 150^\circ\text{C}$, $\theta_{JA} = 100^\circ\text{C/W}$</p>	ORDER PART NUMBER	<p>S8 PACKAGE 8-LEAD PLASTIC SOIC $T_{JMAX} = 150^\circ\text{C}$, $\theta_{JA} = 150^\circ\text{C/W}$</p>	ORDER PART NUMBER
	LT1208CN8		CONTACT FACTORY FOR MILITARY/883B PARTS
			S8 PART MARKING
			1208
<p>N PACKAGE 14-LEAD PLASTIC DIP $T_{JMAX} = 150^\circ\text{C}$, $\theta_{JA} = 70^\circ\text{C/W}$</p>	ORDER PART NUMBER	<p>S PACKAGE 16-LEAD PLASTIC SOIC $T_{JMAX} = 150^\circ\text{C}$, $\theta_{JA} = 100^\circ\text{C/W}$</p>	ORDER PART NUMBER
	LT1209CN		

ELECTRICAL CHARACTERISTICS $V_S = \pm 15V$, $T_A = 25^\circ\text{C}$, $R_L = 1k$, $V_{CM} = 0V$, unless otherwise noted.

SYMBOL	PARAMETER	CONDITIONS	MIN	TYP	MAX	UNITS
V_{OS}	Input Offset Voltage	$V_S = \pm 5V$ (Note 2) 0°C to 70°C	●	0.5	3.0	mV
			●		4.0	mV
		$V_S = \pm 15V$ (Note 2) 0°C to 70°C	●	1.0	5.0	mV
			●		6.0	mV
	Input V_{OS} Drift			25		$\mu\text{V}/^\circ\text{C}$
I_{OS}	Input Offset Current	$V_S = \pm 5V$ and $V_S = \pm 15V$ 0°C to 70°C	●	100	400	nA
			●		600	nA
I_B	Input Bias Current	$V_S = \pm 5V$ and $V_S = \pm 15V$ 0°C to 70°C	●	4	8	μA
			●		9	μA
e_n	Input Noise Voltage	$f = 10\text{kHz}$		22		$\text{nV}/\sqrt{\text{Hz}}$
i_n	Input Noise Current	$f = 10\text{kHz}$		1.1		$\text{pA}/\sqrt{\text{Hz}}$

ELECTRICAL CHARACTERISTICS $V_S = \pm 15V$, $T_A = 25^\circ C$, $R_L = 1k$, $V_{CM} = 0V$, unless otherwise noted.

SYMBOL	PARAMETER	CONDITIONS	MIN	TYP	MAX	UNITS
R_{IN}	Input Resistance	$V_{CM} = \pm 12V$	20	40		M Ω
		Differential		250		k Ω
C_{IN}	Input Capacitance			2		pF
CMRR	Common-Mode Rejection Ratio	$V_S = \pm 15V$, $V_{CM} = \pm 12V$; $V_S = \pm 5V$, $V_{CM} = \pm 2.5V$, $0^\circ C$ to $70^\circ C$	86	98		dB
			83			dB
PSRR	Power Supply Rejection Ratio	$V_S = \pm 5V$ to $\pm 15V$	76	84		dB
		$0^\circ C$ to $70^\circ C$	75			dB
	Input Voltage Range	$V_S = \pm 15V$	± 12	± 13		V
		$V_S = \pm 5V$	± 2.5	± 3		V
A_{VOL}	Large-Signal Voltage Gain	$V_S = \pm 15V$, $V_{OUT} = \pm 10V$, $R_L = 500\Omega$ $0^\circ C$ to $70^\circ C$	3.3	7		V/mV
			2.5			V/mV
		$V_S = \pm 5V$, $V_{OUT} = \pm 2.5V$, $R_L = 500\Omega$ $0^\circ C$ to $70^\circ C$	2.5	7		V/mV
		2.0			V/mV	
		$V_S = \pm 5V$, $V_{OUT} = \pm 2.5V$, $R_L = 150\Omega$		3		V/mV
V_{OUT}	Output Swing	$V_S = \pm 15V$, $R_L = 500\Omega$, $0^\circ C$ to $70^\circ C$	12.0	13.3		$\pm V$
		$V_S = \pm 5V$, $R_L = 150\Omega$, $0^\circ C$ to $70^\circ C$	3.0	3.3		$\pm V$
I_{OUT}	Output Current	$V_S = \pm 15V$, $V_{OUT} = \pm 12V$, $0^\circ C$ to $70^\circ C$	24	40		mA
		$V_S = \pm 5V$, $V_{OUT} = \pm 3V$, $0^\circ C$ to $70^\circ C$	20	40		mA
SR	Slew Rate	$V_S = \pm 15V$, $A_{VCL} = -2$, (Note 3) $0^\circ C$ to $70^\circ C$	250	400		V/ μs
			200			V/ μs
		$V_S = \pm 5V$, $A_{VCL} = -2$, (Note 3) $0^\circ C$ to $70^\circ C$	150	250		V/ μs
			130			V/ μs
	Full Power Bandwidth	10V Peak, (Note 4)		6.4		MHz
GBW	Gain-Bandwidth	$V_S = \pm 15V$, $f = 1MHz$		45		MHz
		$V_S = \pm 5V$, $f = 1MHz$		34		MHz
t_r , t_f	Rise Time, Fall Time	$V_S = \pm 15V$, $A_{VCL} = 1$, 10% to 90%, 0.1V		5		ns
		$V_S = \pm 5V$, $A_{VCL} = 1$, 10% to 90%, 0.1V		7		ns
	Overshoot	$V_S = \pm 15V$, $A_{VCL} = 1$, 0.1V		30		%
		$V_S = \pm 5V$, $A_{VCL} = 1$, 0.1V		20		%
	Propagation Delay	$V_S = \pm 15V$, 50% V_{IN} to 50% V_{OUT}		5		ns
		$V_S = \pm 5V$, 50% V_{IN} to 50% V_{OUT}		7		ns
t_s	Settling Time	$V_S = \pm 15V$, 10V Step, $V_S = \pm 5V$, 5V Step, 0.1%		90		ns
	Differential Gain	$f = 3.58MHz$, $R_L = 150\Omega$		1.30		%
		$f = 3.58MHz$, $R_L = 1k$		0.09		%
	Differential Phase	$f = 3.58MHz$, $R_L = 150\Omega$		1.8		Deg
		$f = 3.58MHz$, $R_L = 1k$		0.1		Deg
R_O	Output Resistance	$A_{VCL} = 1$, $f = 1MHz$		2.5		Ω
	Crosstalk	$V_{OUT} = \pm 10V$, $R_L = 500\Omega$		-100	-94	dB
I_S	Supply Current	Each Amplifier, $V_S = \pm 5V$ and $V_S = \pm 15V$ $0^\circ C$ to $70^\circ C$		7	9	mA
					10.5	mA

The ● denotes the specifications which apply over the full operating temperature range.

Note 1: A heat sink may be required to keep the junction temperature below absolute maximum when the output is shorted indefinitely.

Note 2: Input offset voltage is tested with automated test equipment and is exclusive of warm-up drift.

Note 3: Slew rate is measured in a gain of -2. For $\pm 15V$ supplies measure between $\pm 10V$ on the output with $\pm 6V$ on the input. For $\pm 5V$ supplies measure between $\pm 2V$ on the output with $\pm 1.75V$ on the input.

Note 4: Full power bandwidth is calculated from the slew rate measurement: $FPBW = SR/2\pi V_p$.

TYPICAL PERFORMANCE CHARACTERISTICS

Input Common-Mode Range vs Supply Voltage

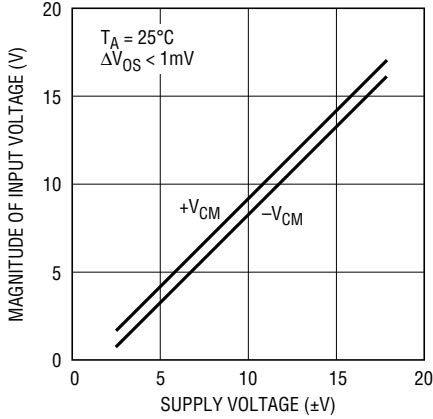

Supply Current vs Supply Voltage and Temperature

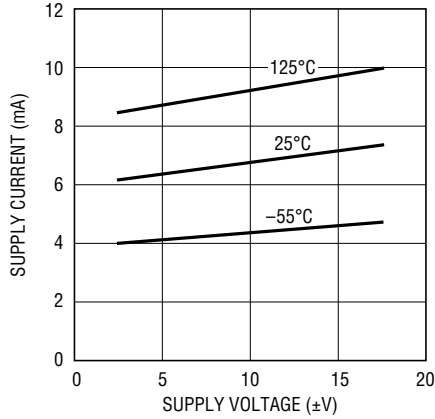

Output Voltage Swing vs Supply Voltage

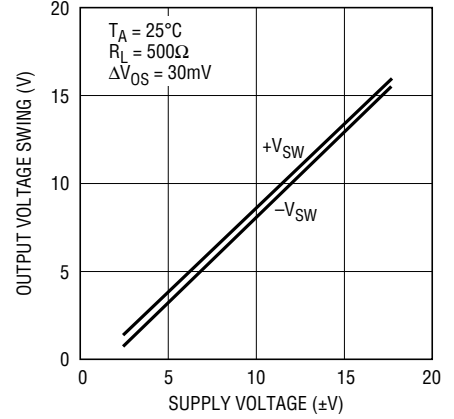

Output Voltage Swing vs Resistive Load

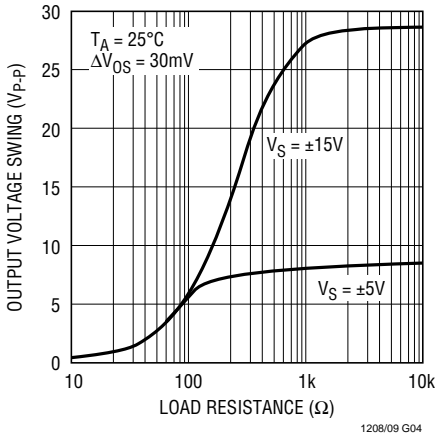

Input Bias Current vs Input Common-Mode Voltage

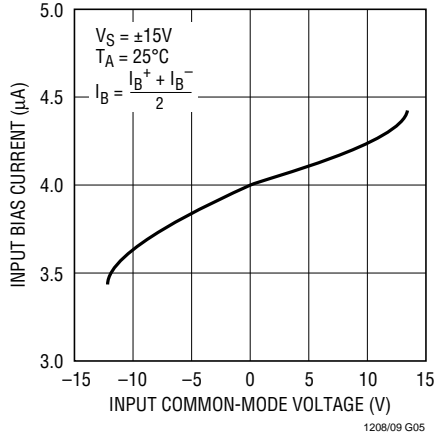

Open-Loop Gain vs Resistive Load

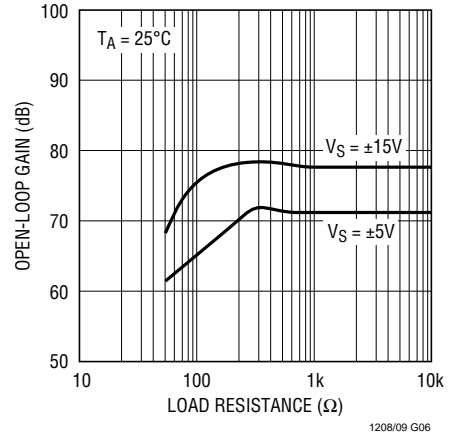

Input Bias Current vs Temperature

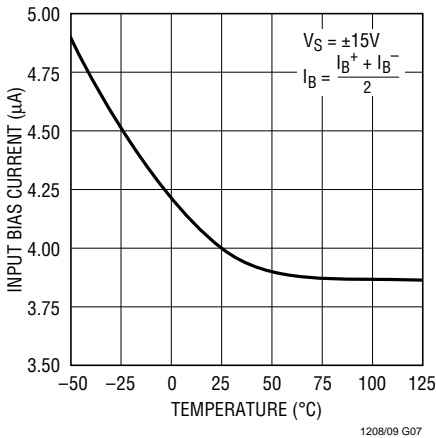

Output Short-Circuit Current vs Temperature

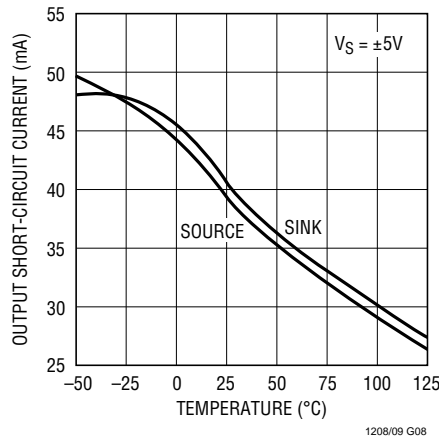

Input Noise Spectral Density

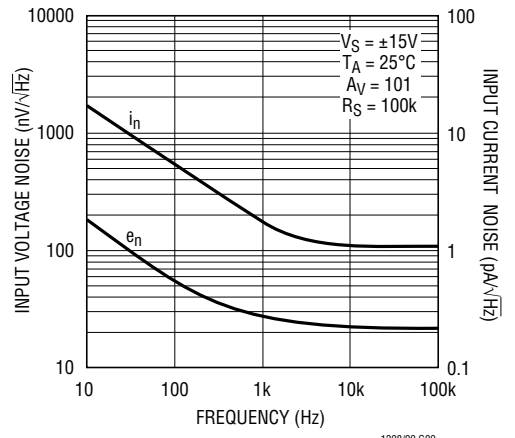

TYPICAL PERFORMANCE CHARACTERISTICS

Crosstalk vs Frequency

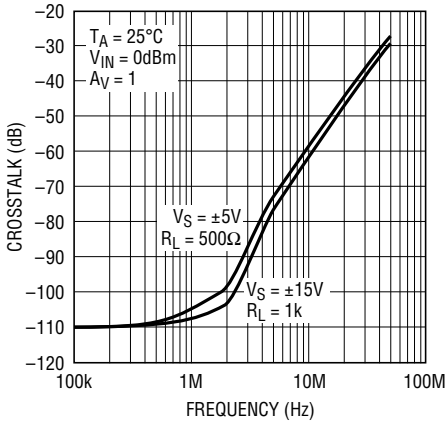

1208/09 G10

Power Supply Rejection Ratio vs Frequency

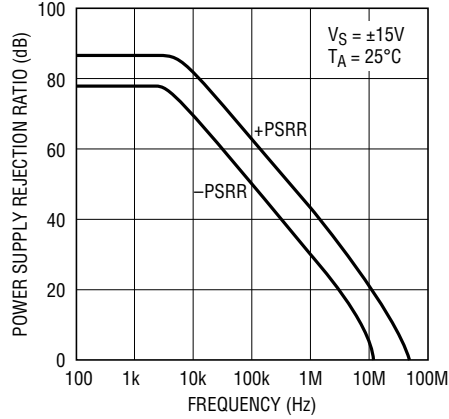

1208/09 G11

Common-Mode Rejection Ratio vs Frequency

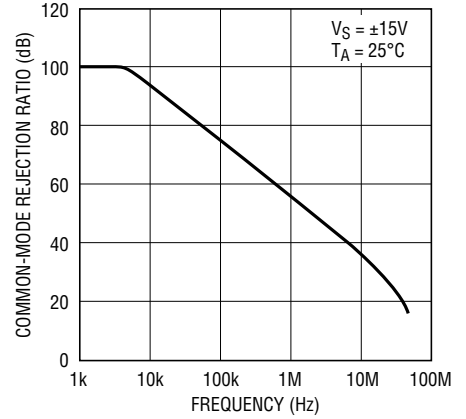

1208/09 G12

Voltage Gain and Phase vs Frequency

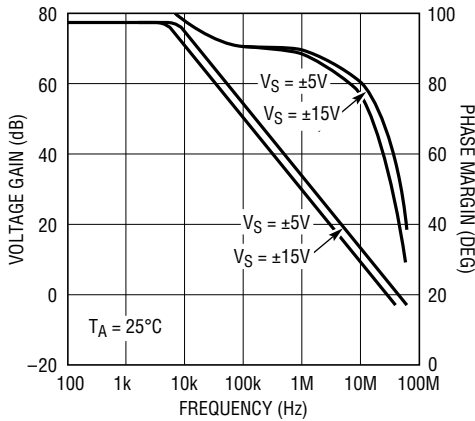

1208/09 B13

Output Swing vs Settling Time

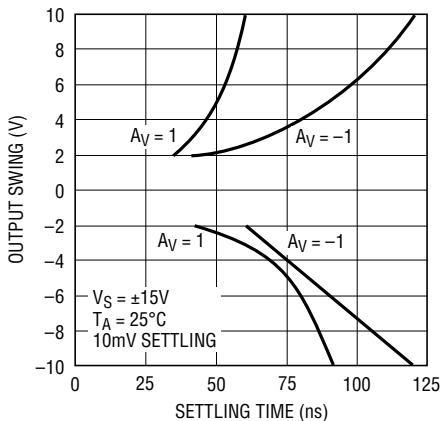

1208/09 G14

Frequency Response vs Capacitive Load

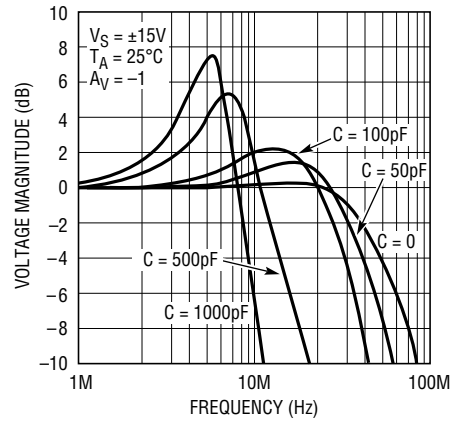

1208/09 G15

Closed-Loop Output Impedance vs Frequency

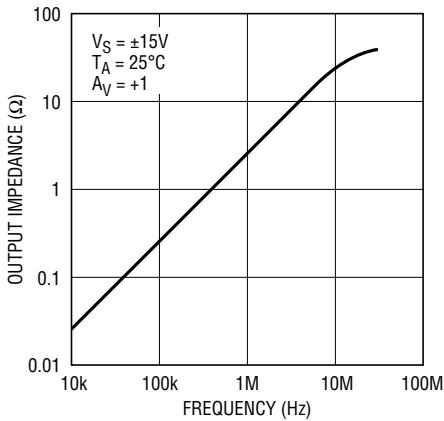

1208/09 G16

Gain-Bandwidth vs Temperature

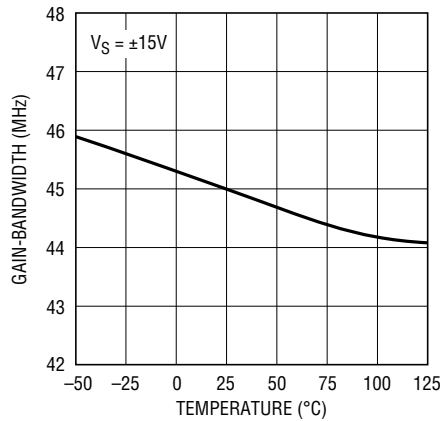

1208/09 G17

Slew Rate vs Temperature

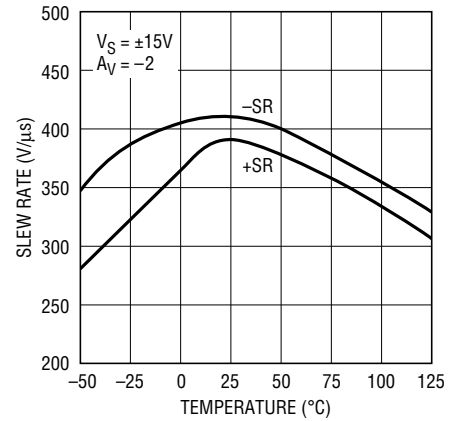

1208/09 G18

TYPICAL PERFORMANCE CHARACTERISTICS

Gain-Bandwidth and Phase Margin vs Supply Voltage

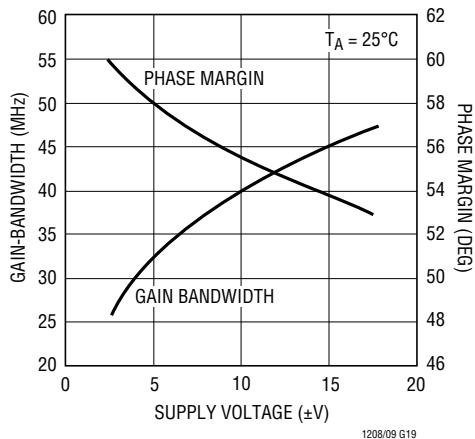

1208/09 G19

Slew Rate vs Supply Voltage

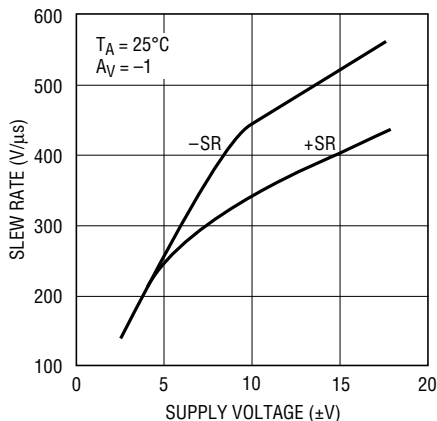

1208/09 G20

Total Harmonic Distortion vs Frequency

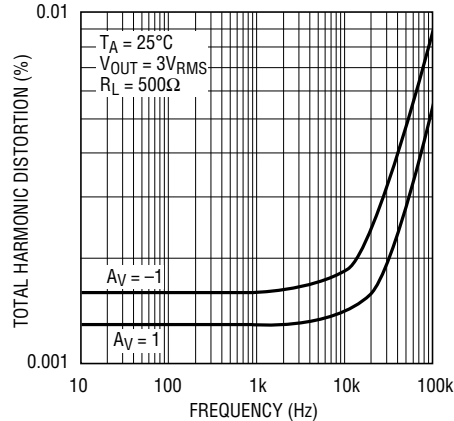

1208/09 G21

APPLICATIONS INFORMATION

Layout and Passive Components

As with any high speed operational amplifier, care must be taken in board layout in order to obtain maximum performance. Key layout issues include: use of a ground plane, minimization of stray capacitance at the input pins, short lead lengths, RF-quality bypass capacitors located close to the device (typically 0.01µF to 0.1µF), and use of low ESR bypass capacitors for high drive current applications (typically 1µF to 10µF tantalum). Sockets should be avoided when maximum frequency performance is required, although low profile sockets can provide reasonable performance up to 50MHz. For more details see Design Note 50. The parallel combination of the feedback resistor and gain setting resistor on the inverting input combine with the input capacitance to form a pole which can cause peaking. If feedback resistors greater than 5k are used, a parallel capacitor of value

$$C_F \geq R_G \times C_{IN}/R_F$$

should be used to cancel the input pole and optimize dynamic performance. For unity-gain applications where a large feedback resistor is used, C_F should be greater than or equal to C_{IN} .

Capacitive Loading

The LT1208/LT1209 amplifiers are stable with capacitive loads. This is accomplished by sensing the load induced output pole and adding compensation at the amplifier gain node. As the capacitive load increases, both the bandwidth and phase margin decrease so there will be peaking in the frequency domain and in the transient response. The photo of the small-signal response with 1000pF load shows 50% peaking. The large-signal response with a 10,000pF load shows the output slew rate being limited by the short-circuit current. To reduce peaking with capacitive loads, insert a small decoupling resistor between the output and the load, and add a capacitor between the output and inverting input to provide an AC feedback path. Coaxial cable can be driven directly, but for best pulse fidelity the cable should be doubly terminated with a resistor in series with the output.

APPLICATIONS INFORMATION

Small-Signal Capacitive Loading

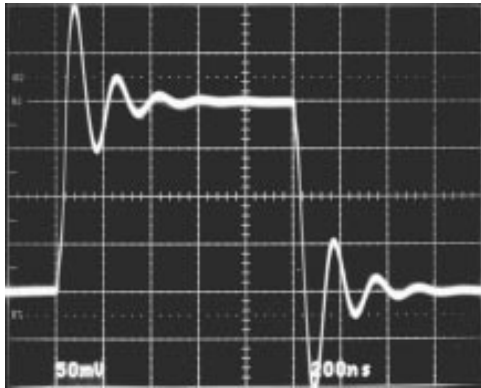

$A_V = -1$
 $C_L = 1000\text{pF}$

1208/09 AI01

caused by a second pole beyond the unity-gain crossover. This is reflected in the 50° phase margin and shows up as overshoot in the unity-gain small-signal transient response. Higher noise gain configurations exhibit less overshoot as seen in the inverting gain of one response.

The large-signal response in both inverting and non-inverting gain show symmetrical slewing characteristics. Normally the noninverting response has a much faster rising edge due to the rapid change in input common-mode voltage which affects the tail current of the input differential pair. Slew enhancement circuitry has been added to the LT1208/LT1209 so that the falling edge slew rate is balanced.

Large-Signal Capacitive Loading

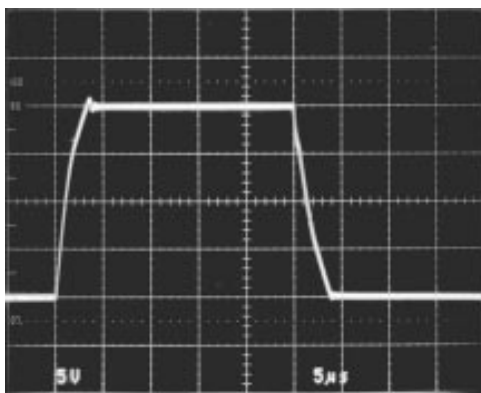

$A_V = 1$
 $C_L = 10,000\text{pF}$

1208/09 AI02

Small-Signal Transient Response

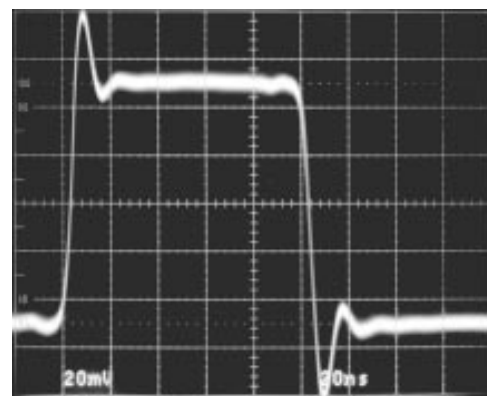

$A_V = 1$

1208/09 AI03

Input Considerations

Resistors in series with the inputs are recommended for the LT1208/LT1209 in applications where the differential input voltage exceeds $\pm 6\text{V}$ continuously or on a transient basis. An example would be in noninverting configurations with high input slew rates or when driving heavy capacitive loads. The use of balanced source resistance at each input is recommended for applications where DC accuracy must be maximized.

Transient Response

The LT1208/LT1209 gain-bandwidth is 45MHz when measured at 100kHz. The actual frequency response in unity-gain is considerably higher than 45MHz due to peaking

Small-Signal Transient Response

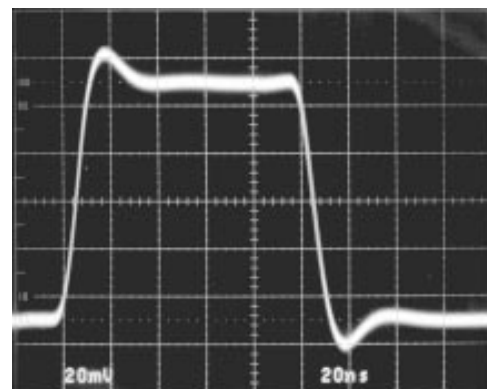

$A_V = -1$

1208/09 AI04

APPLICATIONS INFORMATION

Large-Signal Transient Response

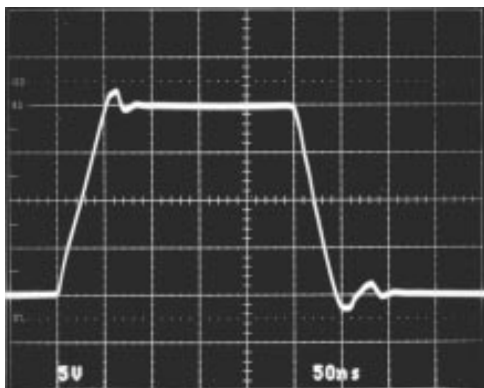

$A_V = 1$

1208/09 AI04

Large-Signal Transient Response

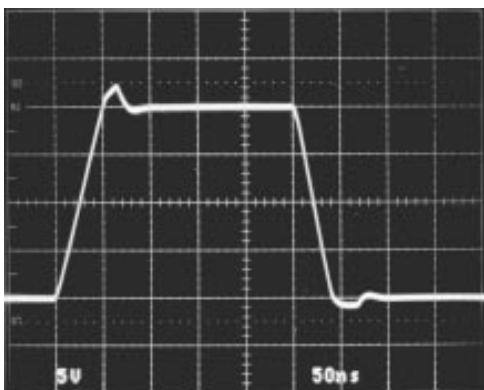

$A_V = -1$

1208/09 AI06

Low Voltage Operation

The LT1208/LT1209 are functional at room temperature with only 3V of total supply voltage. Under this condition, however, the undistorted output swing is only $0.8V_{P-P}$. A more realistic condition is operation at $\pm 2.5V$ supplies (or 5V and ground). Under these conditions, at room temperature, the typical input common-mode range is 1.9V to $-1.3V$ (for a V_{OS} change of 1mV), and a 5MHz, $2V_{P-P}$ sine wave can be faithfully reproduced. With 5V total supply voltage the gain-bandwidth is reduced to 26MHz and the slew rate is reduced to $135V/\mu s$.

Power Dissipation

The LT1208/LT1209 combine high speed and large output current drive in small packages. Because of the wide supply voltage range, it is possible to exceed the maximum junction temperature under certain conditions.

Maximum junction temperature (T_J) is calculated from the ambient temperature (T_A) and power dissipation (P_D) as follows:

$$\text{LT1208CN8: } T_J = T_A + (P_D \times 100^\circ\text{C/W})$$

$$\text{LT1208CS8: } T_J = T_A + (P_D \times 150^\circ\text{C/W})$$

$$\text{LT1209CN: } T_J = T_A + (P_D \times 70^\circ\text{C/W})$$

$$\text{LT1209CS: } T_J = T_A + (P_D \times 100^\circ\text{C/W})$$

Maximum power dissipation occurs at the maximum supply current and when the output voltage is at 1/2 of either supply voltage (or the maximum swing if less than 1/2 supply voltage).

For each amplifier $P_{D\text{MAX}}$ is as follows:

$$P_{D\text{MAX}} = (V^+ - V^-)(I_{S\text{MAX}}) + \frac{(0.5V^+)^2}{R_L}$$

Example: LT1208 in S8 at 70°C , $V_S = \pm 10V$, $R_L = 500\Omega$

$$P_{D\text{MAX}} = (20V)(10.5\text{mA}) + \frac{(5V)^2}{500\Omega} = 260\text{mW}$$

$$T_J = 70^\circ\text{C} + (2 \times 260\text{mW})(150^\circ\text{C/W}) = 148^\circ\text{C}$$

DAC Current-to-Voltage Converter

The wide bandwidth, high slew rate and fast settling time of the LT1208/LT1209 make them well-suited for current-to-voltage conversion after current output D/A converters. A typical application with a DAC-08 type converter (full-scale output of 2mA) uses a 5k feedback resistor. A 7pF compensation capacitor across the feedback resistor is used to null the pole at the inverting input caused by the DAC output capacitance. The combination of the LT1208/LT1209 and DAC settles to less than 40mV (1LSB) in 140ns for a 10V step.

TYPICAL APPLICATIONS

DAC Current-to-Voltage Converter

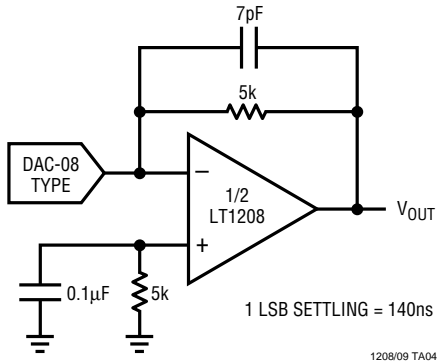

Cable Driving

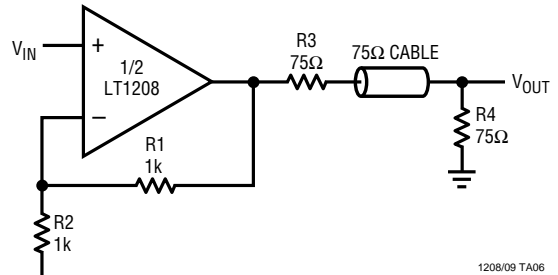

Instrumentation Amplifier

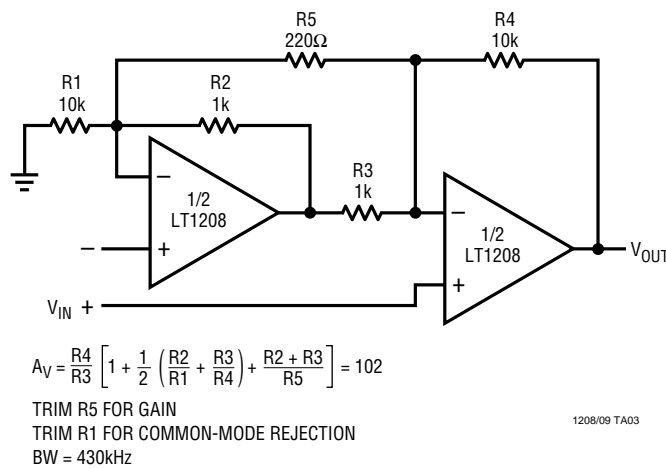

Full-Wave Rectifier

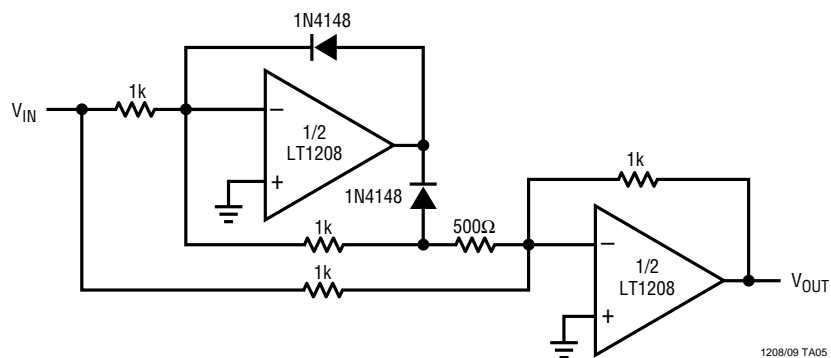

SIMPLIFIED SCHEMATIC

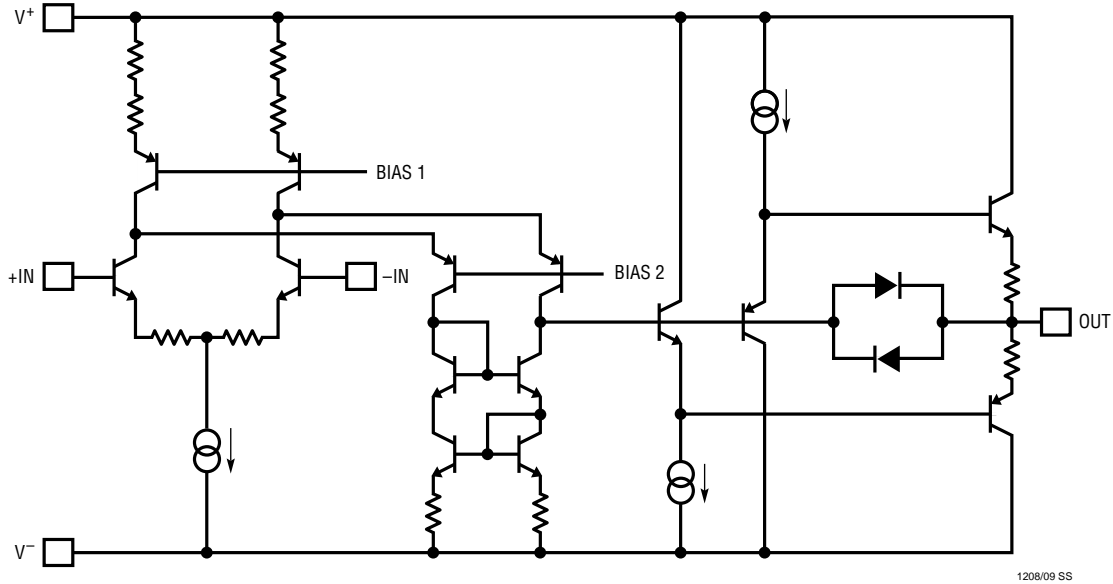

PACKAGE DESCRIPTION Dimensions in inches (millimeters) unless otherwise noted.

**N8 Package
8-Lead Plastic DIP**

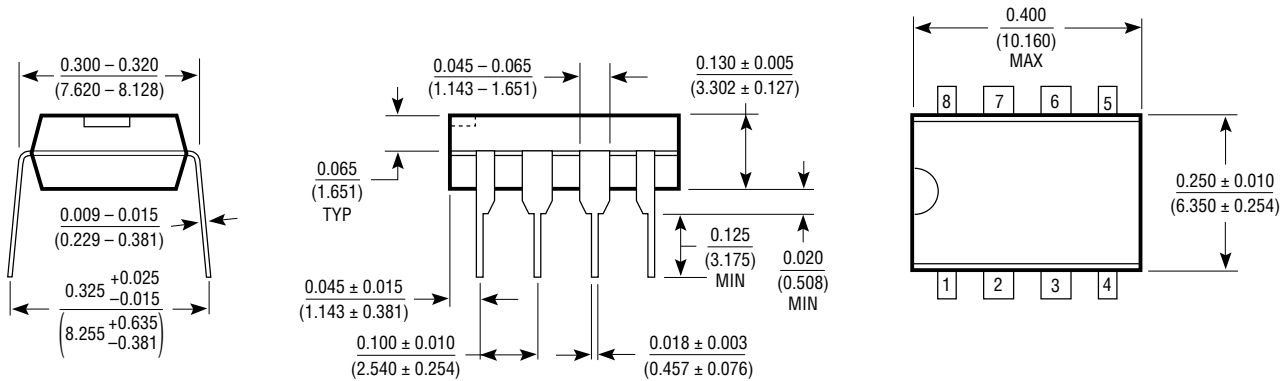

**S8 Package
8-Lead Plastic SOIC**

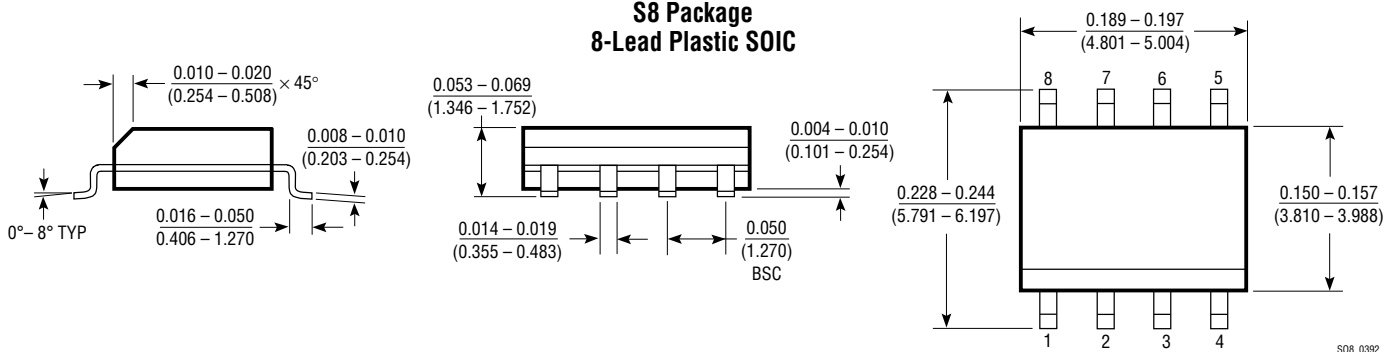

PACKAGE DESCRIPTION Dimensions in inches (millimeters) unless otherwise noted.

**N Package
14-Lead Plastic DIP**

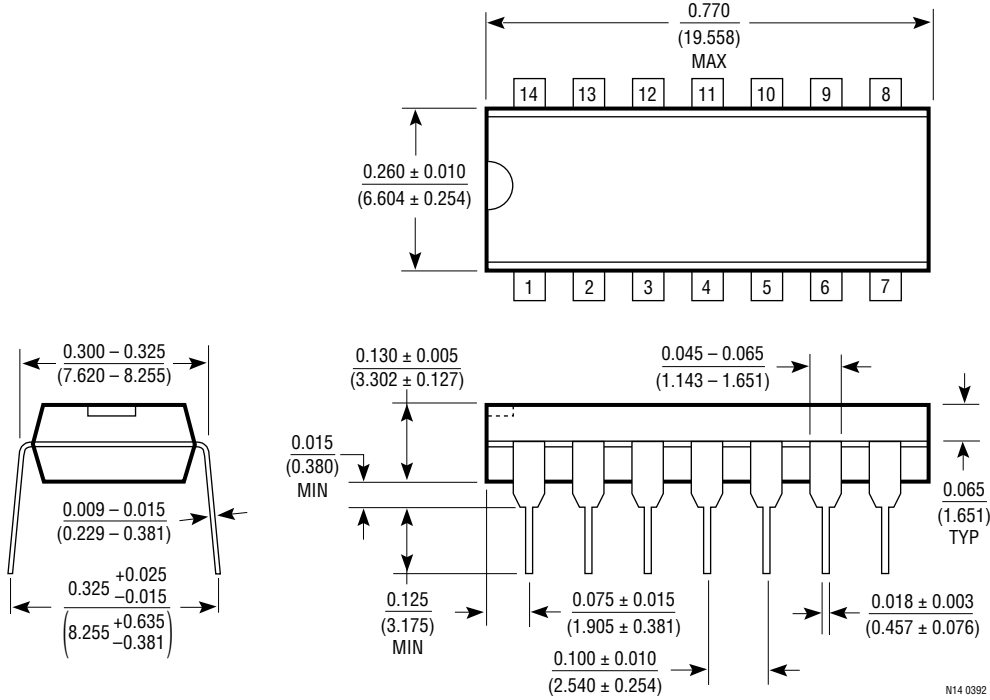

**S Package
16-Lead Plastic SOIC**

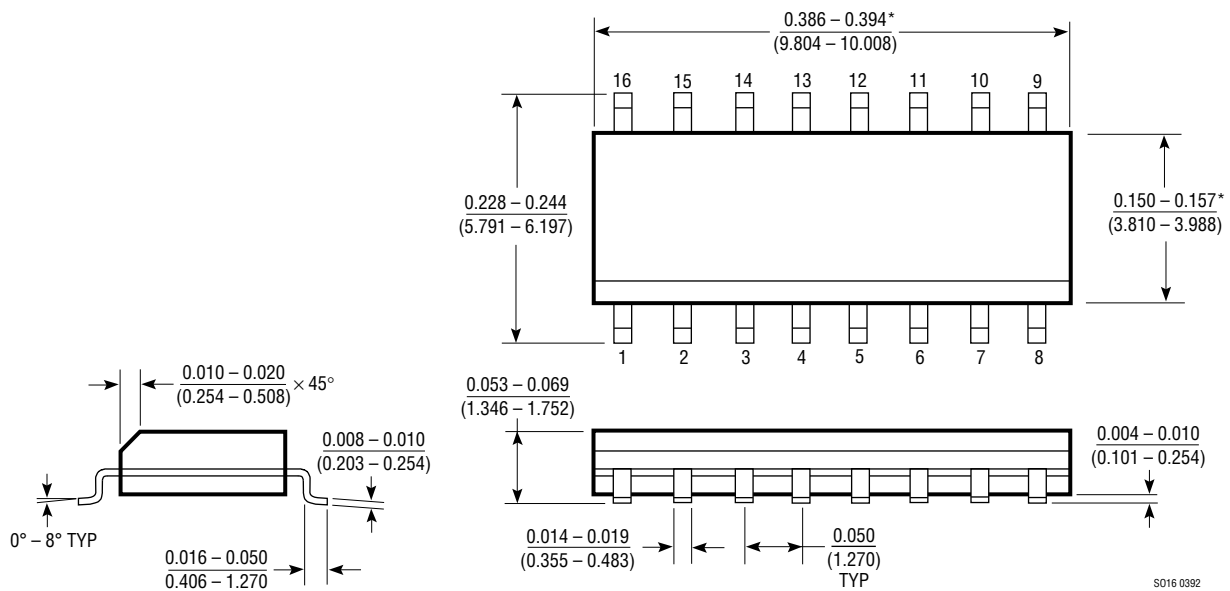

*THESE DIMENSIONS DO NOT INCLUDE MOLD FLASH OR PROTRUSIONS. MOLD FLASH OR PROTRUSIONS SHALL NOT EXCEED 0.006 INCH (0.15mm).

U.S. Area Sales Offices

NORTHEAST REGION

Linear Technology Corporation
One Oxford Valley
2300 E. Lincoln Hwy., Suite 306
Langhorne, PA 19047
Phone: (215) 757-8578
FAX: (215) 757-5631

Linear Technology Corporation

266 Lowell St., Suite B-8
Wilmington, MA 01887
Phone: (508) 658-3881
FAX: (508) 658-2701

SOUTHEAST REGION

Linear Technology Corporation
17060 Dallas Parkway
Suite 208
Dallas, TX 75248
Phone: (214) 733-3071
FAX: (214) 380-5138

CENTRAL REGION

Linear Technology Corporation
Chesapeake Square
229 Mitchell Court, Suite A-25
Addison, IL 60101
Phone: (708) 620-6910
FAX: (708) 620-6977

SOUTHWEST REGION

Linear Technology Corporation
22141 Ventura Blvd.
Suite 206
Woodland Hills, CA 91364
Phone: (818) 703-0835
FAX: (818) 703-0517

NORTHWEST REGION

Linear Technology Corporation
782 Sycamore Dr.
Milpitas, CA 95035
Phone: (408) 428-2050
FAX: (408) 432-6331

International Sales Offices

FRANCE

Linear Technology S.A.R.L.
Immeuble "Le Quartz"
58 Chemin de la Justice
92290 Chatenay Malabry
France
Phone: 33-1-41079555
FAX: 33-1-46314613

KOREA

Linear Technology Korea Branch
Namsong Building, #505
Itaewon-Dong 260-199
Yongsan-Ku, Seoul
Korea
Phone: 82-2-792-1617
FAX: 82-2-792-1619

TAIWAN

Linear Technology Corporation
Rm. 801, No. 46, Sec. 2
Chung Shan N. Rd.
Taipei, Taiwan, R.O.C.
Phone: 886-2-521-7575
FAX: 886-2-562-2285

GERMANY

Linear Technolgy GMBH
Untere Hauptstr. 9
D-8057 Eching
Germany
Phone: 49-89-3197410
FAX: 49-89-3194821

SINGAPORE

Linear Technology Pte. Ltd.
101 Boon Keng Road
#02-15 Kallang Ind. Estates
Singapore 1233
Phone: 65-293-5322
FAX: 65-292-0398

UNITED KINGDOM

Linear Technology (UK) Ltd.
The Coliseum, Riverside Way
Camberley, Surrey GU15 3YL
United Kingdom
Phone: 44-276-677676
FAX: 44-276-64851

JAPAN

Linear Technology KK
5F YZ Bldg.
Iidabashi, Chiyoda-Ku
Tokyo, 102 Japan
Phone: 81-3-3237-7891
FAX: 81-3-3237-8010

World Headquarters

Linear Technology Corporation
1630 McCarthy Blvd.
Milpitas, CA 95035-7487
Phone: (408) 432-1900
FAX: (408) 434-0507

03/10/93

Mouser Electronics

Authorized Distributor

Click to View Pricing, Inventory, Delivery & Lifecycle Information:

[Analog Devices Inc.:](#)

[LT1209CS#PBF](#) [LT1209CS#TR](#) [LT1208CN8](#) [LT1208CS8#PBF](#) [LT1209CN](#) [LT1208CS8#TR](#) [LT1208CS8](#)
[LT1209CS](#) [LT1209CS#TRPBF](#) [LT1208CS8#TRPBF](#) [LT1208CN8#PBF](#) [LT1209CN#PBF](#)