

## LED Drivers for LCD Backlights

# Multifunction Backlight LED Driver for Small LCD Panels (Charge Pump Type)



BD6095GUL, BD6095GU

No.11040EAT31

## ●Description

BD6095GUL/BD6095GU is "Intelligent LED Driver" that is the most suitable for the cellular phone. It has many functions that are needed to "the upper side" of the cellular phone. It has ALC function, that is "Low Power Consumption System" realized. It has "Contents Adaptive Interface" (External PWM control), that is "Low Power Consumption System" realized. It adopts the very thin CSP package that is the most suitable for the slim phone.

## ●Features

- 1) Total 5LEDs driver for LCD Backlight  
It can set maximum 25.6mA /ch by 128steps (Current DAC) for LCD Display.  
3LEDs(LED1~LED3) are same controlled.  
Another 2LEDs(LED4~5) can be independent controlled. (Enable and Current setting)  
2LEDs(LED4~5) can be attributed to "Main Group".  
"Main Group" can be controlled by Auto Luminous Control (ALC) system.  
"Main Group" can be controlled by external PWM signal.
- 2) 1LED driver for Flash/Torch  
It can set maximum 120mA for Flash LED Driver.  
It has Flash mode and Torch mode, there can be changed by external pin or register.
- 3) Auto Luminous Control (ALC)  
Main backlight can be controlled by ambient brightness.  
Photo Diode, Photo Transistor, Photo IC(Linear/Logarithm) can be connected.  
Bias source for ambient light sensor, gain and offset adjustment are built in.  
LED driver current as ambient level can be customized.
- 4) 2ch Series Regulator (LDO)  
It has selectable output voltage by the register.  
LDO1, LDO2 : I<sub>max</sub>=150mA
- 5) Charge Pump DC/DC for LED driver  
It has x1/x1.33/x1.5/x2 mode that will be selected automatically.  
Soft start functions  
Over voltage protection (Auto-return type)  
Over current protection (Auto-return type)
- 6) Thermal shutdown (Auto-return type)
- 7) I<sup>2</sup>C BUS FS mode (max 400kHz)
- 8) VCSP50L3 (3.75mm<sup>2</sup>, 0.55mm max) Small and thin CSP package (BD6095GUL)
- 9) VCSP85H3 (3.75mm<sup>2</sup>, 1.0mm max) Small and thin CSP package (BD6095GU)

\*This chip is not designed to protect itself against radioactive rays.

\*This material may be changed on its way to designing.

\*This material is not the official specification.

## ●Absolute Maximum Ratings (Ta=25 °C)

Parameter	Symbol	Ratings	Unit
Maximum voltage	V <sub>MAX</sub>	7	V
Power Dissipation	P <sub>d</sub>	1500	mW
Operating Temperature Range	T <sub>opr</sub>	-35 ~ +85	°C
Storage Temperature Range	T <sub>stg</sub>	-55 ~ +150	°C

note) Power dissipation deleting is 12.0mW/°C, when it's used in over 25 °C. (It's deleting is on the board that is ROHM's standard)

● Operating conditions (VBAT ≥ VIO, Ta = -35~85 °C)

Parameter	Symbol	Rating	Unit
VBAT input voltage	VBAT	2.7~5.5	V
VIO pin voltage	VIO	1.65~3.3	V

● Electrical Characteristics (Unless otherwise specified, Ta = 25 °C, VBAT = 3.6V, VIO = 1.8V)

Parameter	Symbol	Limits			Unit	Condition
		Min.	Typ.	Max.		
<b>【Circuit Current】</b>						
VBAT Circuit current 1	IBAT1	-	0.1	1.0	μA	RESETB=0V, VIO=0V
VBAT Circuit current 2	IBAT2	-	0.5	3.0	μA	RESETB=0V, VIO=1.8V
VBAT Circuit current 3	IBAT3	-	90	150	μA	LDO1=LDO2=ON, ILDO=0mA Other blocks=OFF
VBAT Circuit current 4	IBAT4	-	61	65	mA	DC/DC x1mode, ILED=60mA VBAT=3.7V, LED Vf=3.0V
VBAT Circuit current 5	IBAT5	-	83	94	mA	DC/DC x1.33mode, ILED=60mA VBAT=3.1V, LED Vf=3.0V
VBAT Circuit current 6	IBAT6	-	93	104	mA	DC/DC x1.5mode, ILED=60mA VBAT=2.9V, LED Vf=3.5V
VBAT Circuit current 7	IBAT7	-	124	136	mA	DC/DC x2mode, ILED=60mA VBAT=3.2V, LED Vf=4.0V
VBAT Circuit current 8	IBAT8	-	0.25	1.0	mA	Only ALC block ON ADCYC=0.5s setting Except sensor current
<b>【LED Driver】</b>						
LED current Step (Setup)	ILEDSTP1	128			Step	LED1~5
LED current Step (At slope)	ILEDSTP2	256			Step	LED1~5
LED current Step (Flash)	ILEDSTPFL	32			Step	LEDFL
White LED Maximum setup current	IMAXWLED	-	25.6	-	mA	LED1~5
Flash LED Maximum setup current	IMAXFLED	-	120	-	mA	LEDFL
LED1~5 current accuracy	IWLED	-7%	15	+7%	mA	ILED=15mA setting at VLED=1.0V
Flash LED current accuracy	IFLED	-7%	60	+7%	mA	ILED=60mA setting at VLED=1.0V
LED current Matching	ILEDMT	-	-	4	%	Between LED1~5 at VLED=1.0V
LED OFF Leak current	ILKLED	-	-	1.0	μA	VLED=4.5V
<b>【DC/DC (Charge Pump)】</b>						
Maximum Output voltage	VoCP	4.65	5.1	5.55	V	
Current Load	IOUT	-	-	250	mA	VBAT ≥ 3.2V, VOUT = 4V
Oscillator frequency	fosc	0.8	1.0	1.2	MHz	
Over Voltage Protection detect voltage	OVP	-	-	6.0	V	
Short Circuit current limit	Ilim	-	125	250	mA	VOUT = 0V
<b>【I<sup>2</sup>C Input (SDA, SCL)】</b>						
LOW level input voltage	VIL	-0.3	-	0.25 × VIO	V	
HIGH level input voltage	VIH	0.75 × VIO	-	VBAT + 0.3	V	
Hysteresis of Schmitt trigger input	Vhys	0.05 × VIO	-	-	V	
LOW level output voltage (SDA) at 3mA sink current	VOL	0	-	0.3	V	
Input current each I/O pin	Iin	-3	-	3	μA	Input voltage = 0.1 × VIO ~ 0.9 × VIO
<b>【RESETB】</b>						
LOW level input voltage	VIL	-0.3	-	0.25 × VIO	V	
HIGH level input voltage	VIH	0.75 × VIO	-	VBAT + 0.3	V	
Input current each I/O pin	Iin	-3	-	3	μA	Input voltage = 0.1 × VIO ~ 0.9 × VIO

●Electrical Characteristics (Unless otherwise specified, Ta=25°C, VBAT=3.6V, VIO=1.8V)

Parameter	Symbol	Limits			Unit	Condition
		Min.	Typ.	Max.		
<b>【Regulator (LDO1)】</b>						
Output voltage	Vo1	1.164	1.20	1.236	V	Io=50mA
		1.261	1.30	1.339	V	Io=50mA
		1.455	1.50	1.545	V	Io=50mA
		1.552	1.60	1.648	V	Io=50mA
		1.746	1.80	1.854	V	Io=50mA <Initial Voltage>
		2.134	2.20	2.266	V	Io=50mA
		2.328	2.40	2.472	V	Io=50mA
		2.425	2.50	2.575	V	Io=50mA
		2.522	2.60	2.678	V	Io=50mA
		2.619	2.70	2.781	V	Io=50mA
		2.716	2.80	2.884	V	Io=50mA
		2.813	2.90	2.987	V	Io=50mA
		2.910	3.00	3.090	V	Io=50mA
		3.007	3.10	3.193	V	Io=50mA
		3.104	3.20	3.296	V	Io=50mA
3.201	3.30	3.399	V	Io=50mA		
Output Current	Io1	-	-	150	mA	Vo=1.8V
Dropout Voltage	Vsat1	-	0.05	0.1	V	VBAT=2.5V, Io=50mA, Vo=2.8V
Load stability	ΔVo11	-	10	60	mV	Io=1~150mA, Vo=1.8V
Input voltage stability	ΔVo12	-	10	60	mV	VBAT=3.4~4.5V, Io=50mA, Vo=1.8V
Ripple Rejection Ratio	RR1	-	65	-	dB	f=100Hz, Vin=200mVp-p, Vo=1.2V Io=50mA, BW=20Hz~20kHz
Short circuit current limit	Ilim1	-	200	400	mA	Vo=0V
Discharge resister at OFF	ROFF1	-	1.0	1.5	kΩ	
<b>【Regulator (LDO2)】</b>						
Output voltage	Vo2	1.164	1.20	1.236	V	Io=50mA
		1.261	1.30	1.339	V	Io=50mA
		1.455	1.50	1.545	V	Io=50mA
		1.552	1.60	1.648	V	Io=50mA
		1.746	1.80	1.854	V	Io=50mA
		2.134	2.20	2.266	V	Io=50mA
		2.328	2.40	2.472	V	Io=50mA
		2.425	2.50	2.575	V	Io=50mA <Initial Voltage>
		2.522	2.60	2.678	V	Io=50mA
		2.619	2.70	2.781	V	Io=50mA
		2.716	2.80	2.884	V	Io=50mA
		2.813	2.90	2.987	V	Io=50mA
		2.910	3.00	3.090	V	Io=50mA
		3.007	3.10	3.193	V	Io=50mA
		3.104	3.20	3.296	V	Io=50mA
3.201	3.30	3.399	V	Io=50mA		
Output Current	Io2	-	-	150	mA	Vo=2.5V
Dropout Voltage	Vsat2	-	0.05	0.1	V	VBAT=2.5V, Io=50mA, Vo=2.8V
Load stability	Δvo21	-	10	60	mV	Io=1~150mA, Vo=2.5V
Input voltage stability	Δvo22	-	10	60	mV	VBAT=3.4~4.5V, Io=50mA, Vo=2.5V
Ripple Rejection Ratio	RR2	-	65	-	dB	f=100Hz, Vin=200mVp-p, Vo=1.2V Io=50mA, BW=20Hz~20kHz
Short circuit current limit	Ilim2	-	200	400	mA	Vo=0V
Discharge resister at OFF	ROFF2	-	1.0	1.5	kΩ	

## ● Electrical Characteristics (Unless otherwise specified, Ta=25°C, VBAT=3.6V, VIO=1.8V)

Parameter	Symbol	Limits			Unit	Condition
		Min.	Typ.	Max.		
<b>【Sensor Interface】</b>						
SBIAS Output voltage	VoS	2.850	3.0	3.150	V	Io=200μA <Initial Voltage>
		2.470	2.6	2.730	V	Io=200μA
SBIAS Output current	IoS	-	-	30	mA	Vo=3.0V
SSENS Input range	VISS	0	-	VoS x 255/256	V	
SBIAS Discharge resistor at OFF	ROFFS	-	1.0	1.5	kΩ	
ADC resolution	ADRES	8			bit	
ADC non-linearity error	ADINL	-3	-	+3	LSB	
ADC differential non-linearity error	ADDNL	-1	-	+1	LSB	
SSENS Input impedance	RSENS	1	-	-	MΩ	
<b>【WPWMIN】</b>						
L level input voltage	VILA	-0.3	-	0.3	V	
H level input voltage	VIHA	1.4	-	VBAT +0.3	V	
Input current	IinA	-	3.6	10	μA	Vin=1.8V
PWM input minimum High pulse width	PWpwm	80	-	-	μs	
<b>【GC1, GC2】</b>						
L level output voltage	VOLS	-	-	0.2	V	IOL=1mA
H level output voltage	VOHS	VoS -0.2	-	-	V	IOH=1mA
<b>【FLASHCNT】</b>						
L level input voltage	VILF	-0.3	-	0.3	V	
H level input voltage	VIHF	1.4	-	VBAT +0.3	V	
Input current	IinF	-	3.6	10	μA	Vin=1.8V

●Block Diagram / Application Circuit example

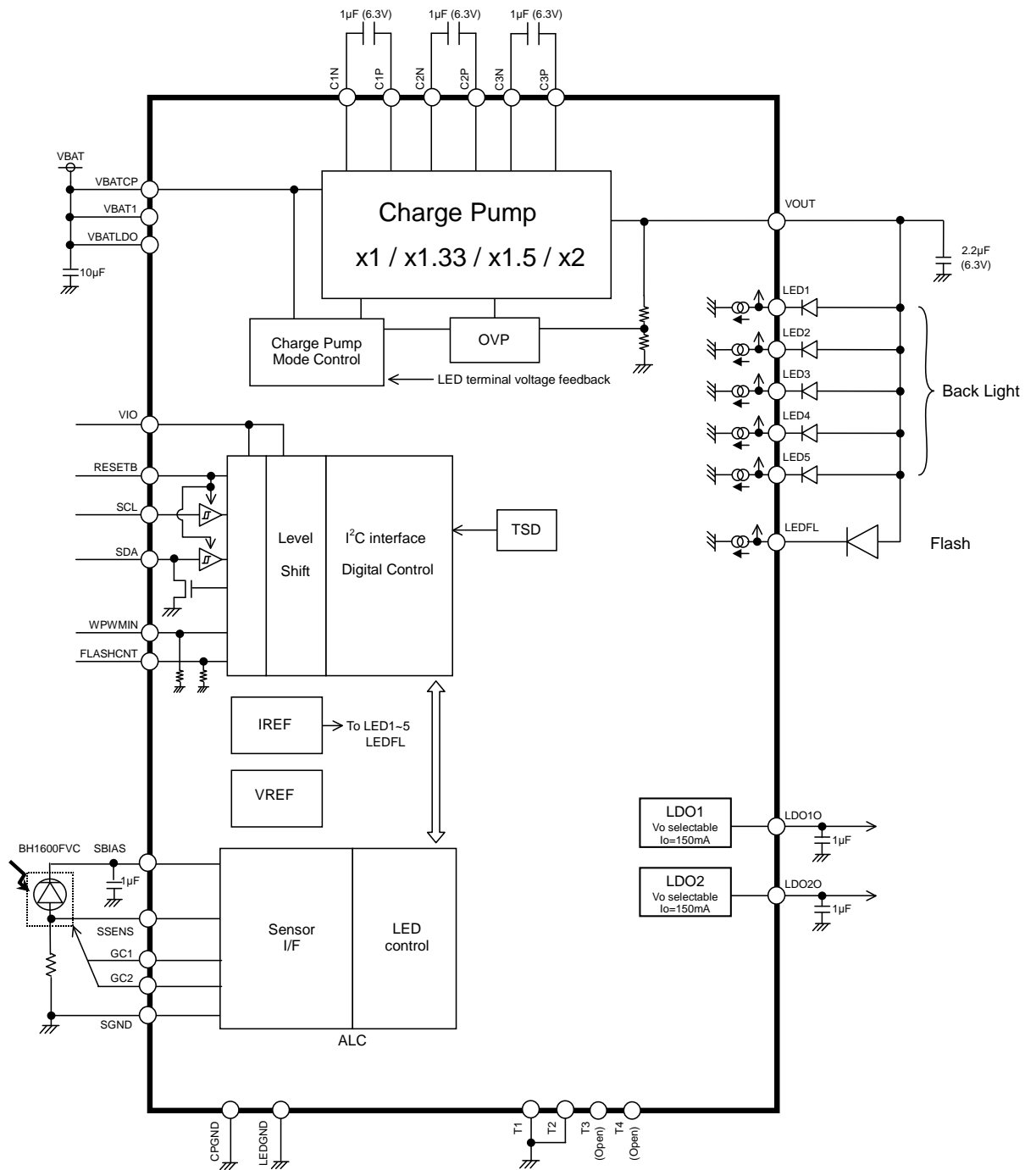
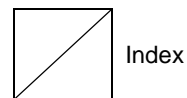

Fig.1 Block Diagram / Application Circuit example

● Pin Arrangement [Bottom View]

F	T4	LDO1O	SSENS	VBAT1	SBIAS	T3
E	VBATLDO	LDO2O	GC2	GC1	SGND	VIO
D	WPWMIN	LED1	FLASHCNT	SDA	SCL	C1N
C	LED3	LED2	/	RESETB	C1P	C2N
B	LED4	LED5	LEDGND	VOUT	VBATCP	C2P
A	T1	LEDFL	CPGND	C3N	C3P	T2
	1	2	3	4	5	6



Total: 35 balls

● Package

- BD6095GUL
- VCSP50L3
- SIZE : 3.75mm
- A ball pitch : 0.5mm
- Height : 0.55mm max

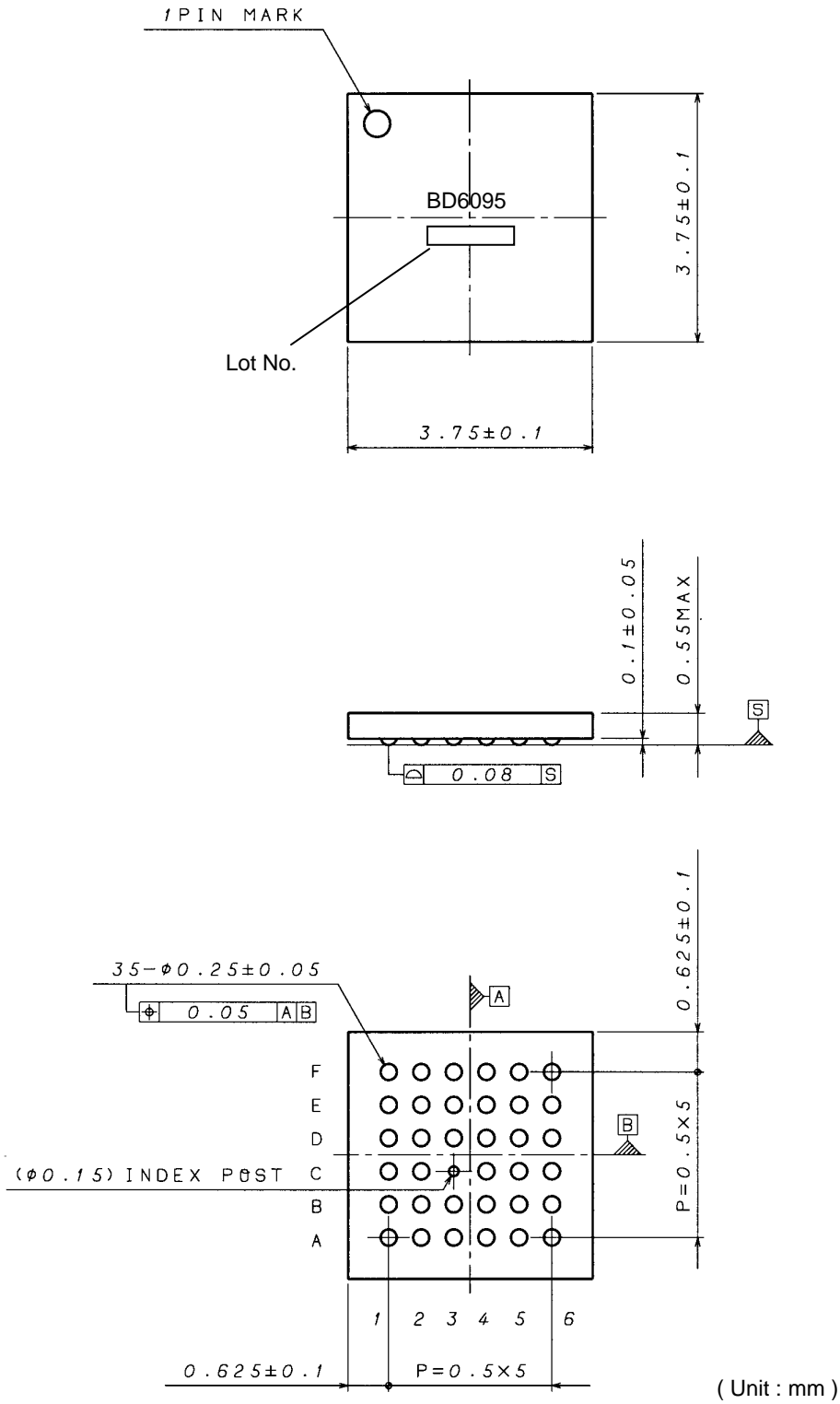

- BD6095GU
- VCSP85H3
- SIZE : 3.75mm
- A ball pitch : 0.5mm
- Height : 1.0mm max

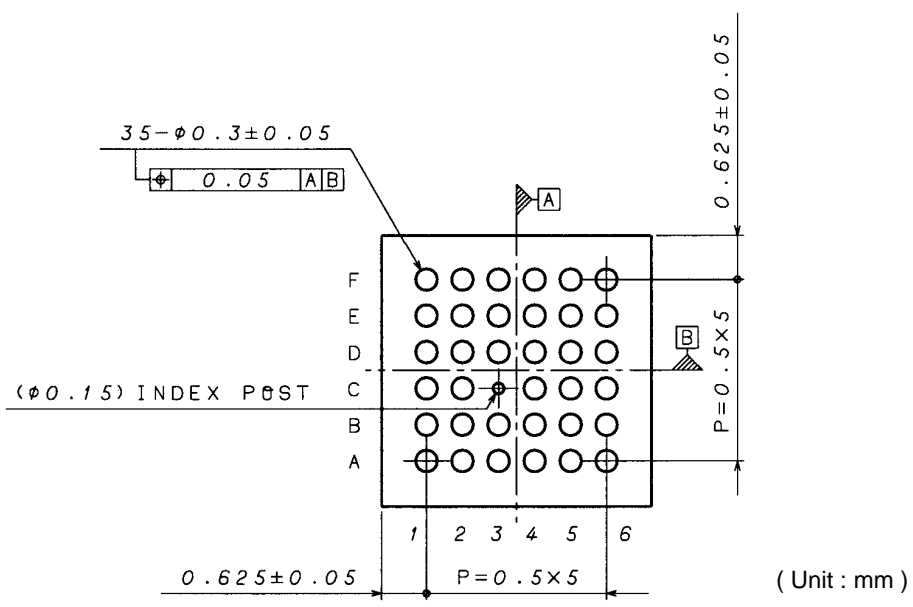
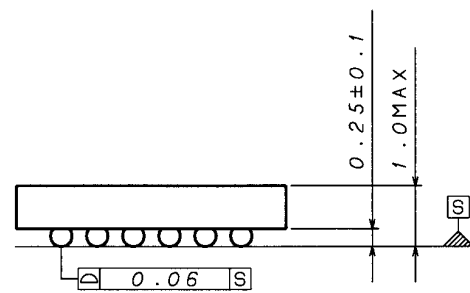
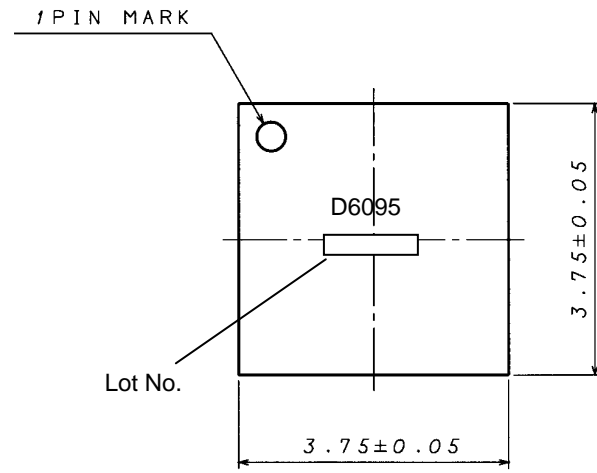

## ● Pin Functions

No	Ball No.	Pin Name	I/O	ESD Diode		Functions	Equivalent Circuit
				For Power	For Ground		
1	B5	VBATCP	-	-	GND	Power supply for charge pump	A
2	F4	VBAT1	-	-	GND	Power supply	A
3	E1	VBATLDO	-	-	GND	Power supply for LDO	A
4	A1	T1	I	VBAT	GND	Test Input Pin (short to Ground)	S
5	A6	T2	I	VBAT	GND	Test Input Pin (short to Ground)	S
6	F6	T3	O	VBAT	GND	Test Output Pin (Open)	M
7	F1	T4	O	VBAT	GND	Test Output Pin (Open)	N
8	E6	VIO	-	VBAT	GND	Power supply for I/O and Digital	C
9	C4	RESETB	I	VBAT	GND	Reset input (L: reset, H: reset cancel)	H
10	D4	SDA	I/O	VBAT	GND	I <sup>2</sup> C data input / output	I
11	D5	SCL	I	VBAT	GND	I <sup>2</sup> C clock input	H
12	A3	CPGND	-	VBAT	-	Ground	B
13	B3	LEDGND	-	VBAT	-	Ground	B
14	D6	C1N	I/O	VBAT	GND	Charge Pump capacitor is connected	F
15	C5	C1P	I/O	-	GND	Charge Pump capacitor is connected	G
16	C6	C2N	I/O	VBAT	GND	Charge Pump capacitor is connected	F
17	B6	C2P	I/O	-	GND	Charge Pump capacitor is connected	G
18	A4	C3N	I/O	VBAT	GND	Charge Pump capacitor is connected	F
19	A5	C3P	I/O	-	GND	Charge Pump capacitor is connected	G
20	B4	VOOUT	O	-	GND	Charge Pump output pin	A
21	F2	LDO1O	O	VBAT	GND	LDO1 output pin	Q
22	E2	LDO2O	O	VBAT	GND	LDO2 output pin	Q
23	D2	LED1	I	-	GND	LED cathode connection 1	E
24	C2	LED2	I	-	GND	LED cathode connection 2	E
25	C1	LED3	I	-	GND	LED cathode connection 3	E
26	B1	LED4	I	-	GND	LED cathode connection 4	E
27	B2	LED5	I	-	GND	LED cathode connection 5	E
28	A2	LEDFL	I	-	GND	LED cathode connection for Flash	E
29	F5	SBIAS	O	VBAT	GND	Bias output for the Ambient Light Sensor	Q
30	F3	SSENS	I	VBAT	GND	Ambient Light Sensor input	N
31	E4	GC1	O	VBAT	GND	Ambient Light Sensor gain control output 1	X
32	E3	GC2	O	VBAT	GND	Ambient Light Sensor gain control output 2	X
33	E5	SGND	-	VBAT	-	Ground	B
34	D1	WPWMIN	I	VBAT	GND	External PWM input for Back Light	L
35	D3	FLASHCNT	I	VBAT	GND	External enable for Flash	L

※ The LED terminal that isn't used is to short-circuit to the ground. But, the setup of a register concerned with LED that isn't used is prohibited.

Total: 35 Pin

●Equivalent Circuit

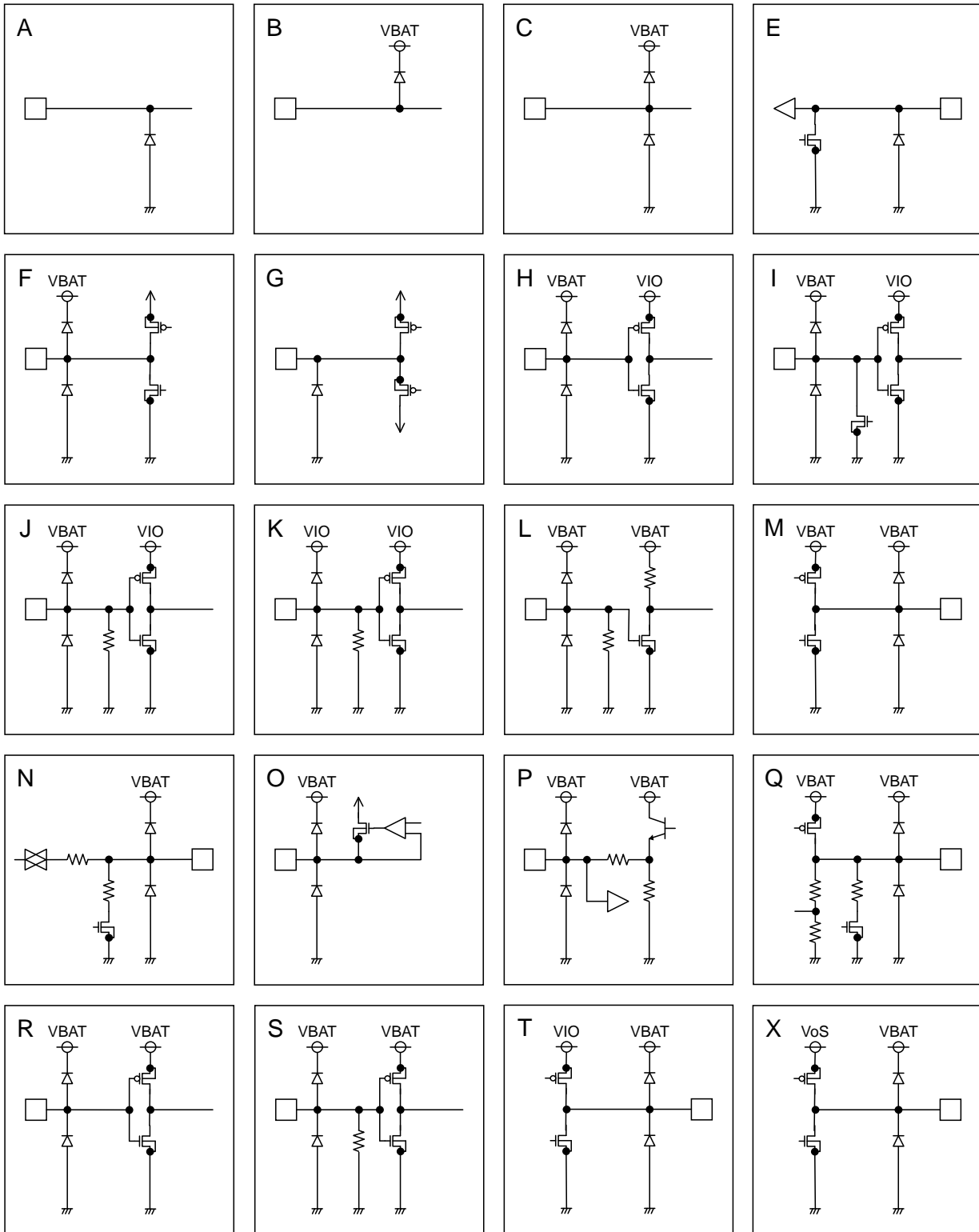

● I<sup>2</sup>C BUS format

The writing/reading operation is based on the I<sup>2</sup>C slave standard.

• Slave address

A7	A6	A5	A4	A3	A2	A1	R/W
1	1	1	0	1	1	0	1/0

• Bit Transfer

SCL transfers 1-bit data during H. SCL cannot change signal of SDA during H at the time of bit transfer. If SDA changes while SCL is H, START conditions or STOP conditions will occur and it will be interpreted as a control signal.

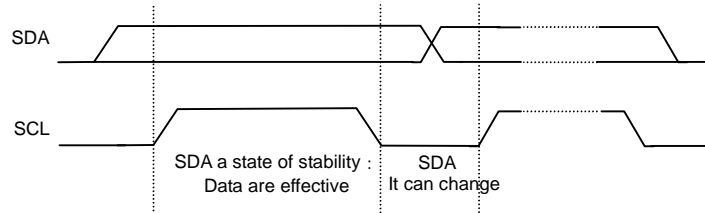

• START and STOP condition

When SDA and SCL are H, data is not transferred on the I<sup>2</sup>C- bus. This condition indicates, if SDA changes from H to L while SCL has been H, it will become START (S) conditions, and an access start, if SDA changes from L to H while SCL has been H, it will become STOP (P) conditions and an access end.

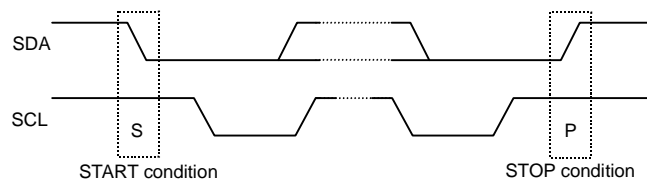

• Acknowledge

It transfers data 8 bits each after the occurrence of START condition. A transmitter opens SDA after transfer 8bits data, and a receiver returns the acknowledge signal by setting SDA to L.

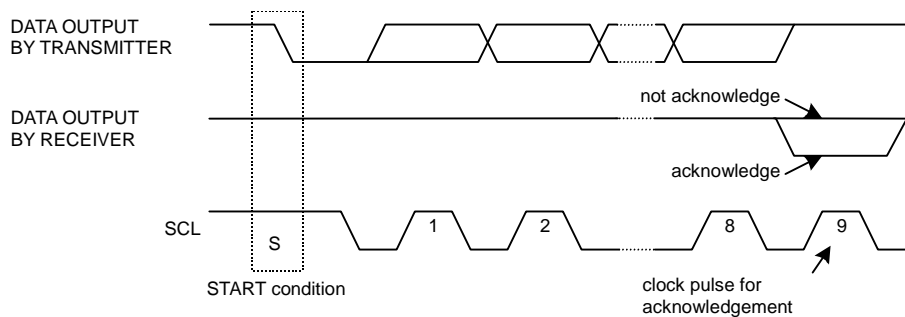

• Writing protocol

A register address is transferred by the next 1 byte that transferred the slave address and the write-in command. The 3rd byte writes data in the internal register written in by the 2nd byte, and after 4th byte or, the increment of register address is carried out automatically. However, when a register address turns into the last address, it is set to 00h by the next transmission. After the transmission end, the increment of the address is carried out.

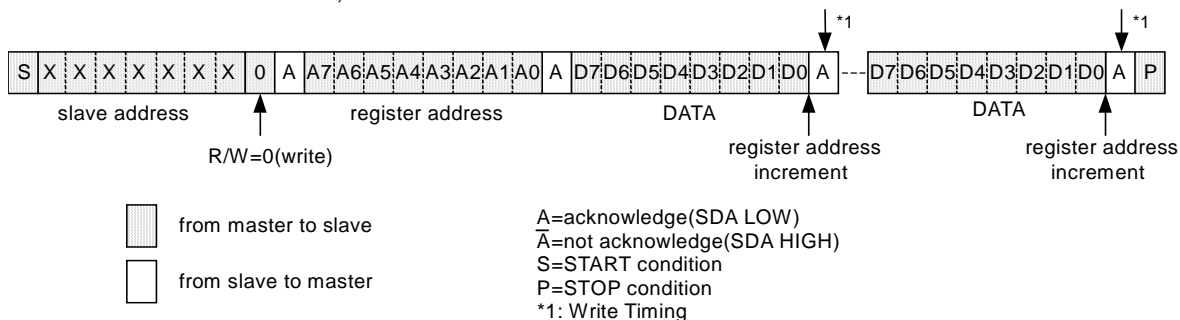

• Reading protocol

It reads from the next byte after writing a slave address and R/W bit. The register to read considers as the following address accessed at the end, and the data of the address that carried out the increment is read after it. If an address turns into the last address, the next byte will read out 00h. After the transmission end, the increment of the address is carried out.

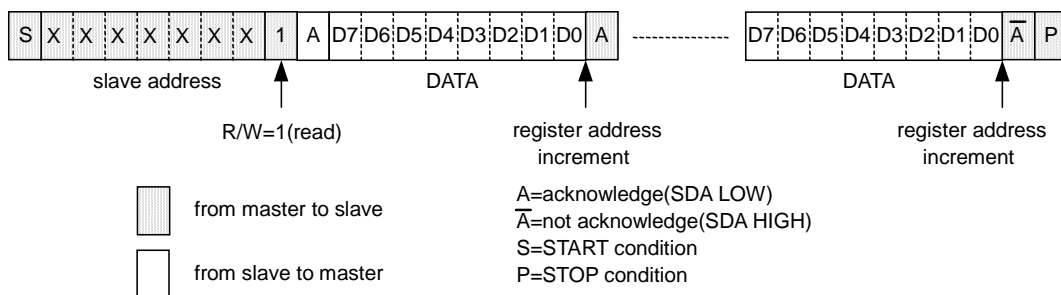

• Multiple reading protocols

After specifying an internal address, it reads by repeated START condition and changing the data transfer direction. The data of the address that carried out the increment is read after it. If an address turns into the last address, the next byte will read out 00h. After the transmission end, the increment of the address is carried out.

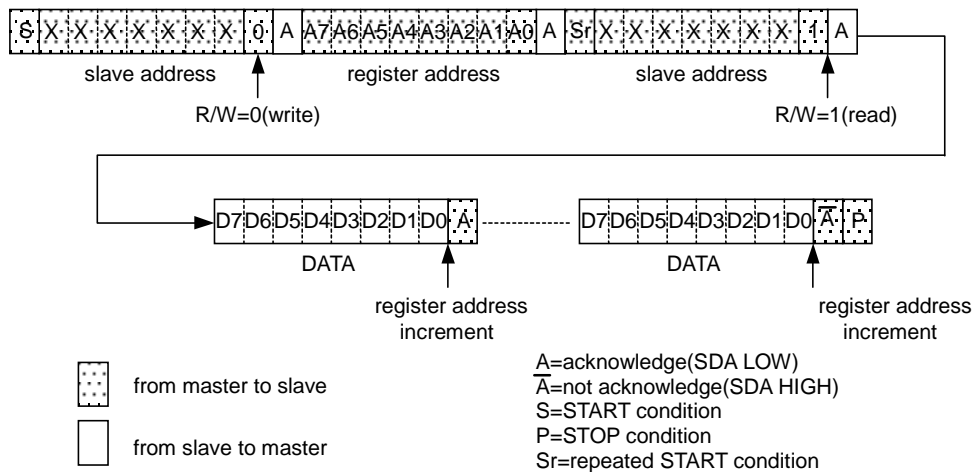

As for reading protocol and multiple reading protocols, please do  $\bar{A}$ (not acknowledge) after doing the final reading operation. It stops with read when ending by A(acknowledge), and SDA stops in the state of Low when the reading data of that time is 0. However, this state returns usually when SCL is moved, data is read, and A(not acknowledge) is done.

## ● Timing diagram

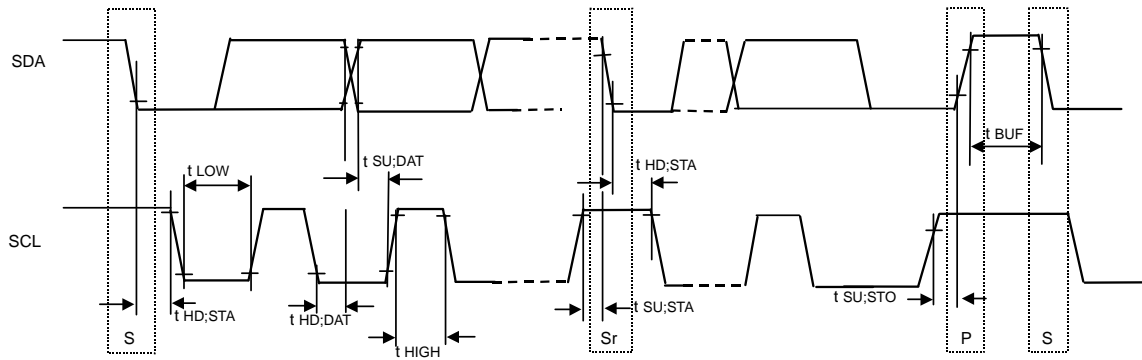
● Electrical Characteristics (Unless otherwise specified,  $T_a=25\text{ }^\circ\text{C}$ ,  $V_{BAT}=3.6\text{V}$ ,  $V_{IO}=1.8\text{V}$ )

Parameter	Symbol	Standard-mode			Fast-mode			Unit
		Min.	Typ.	Max.	Min.	Typ.	Max.	
<b>【I<sup>2</sup>C BUS format】</b>								
SCL clock frequency	fSCL	0	-	100	0	-	400	kHz
LOW period of the SCL clock	tLOW	4.7	-	-	1.3	-	-	$\mu\text{s}$
HIGH period of the SCL clock	tHIGH	4.0	-	-	0.6	-	-	$\mu\text{s}$
Hold time (repeated) START condition After this period, the first clock is generated	tHD;STA	4.0	-	-	0.6	-	-	$\mu\text{s}$
Set-up time for a repeated START condition	tSU;STA	4.7	-	-	0.6	-	-	$\mu\text{s}$
Data hold time	tHD;DAT	0	-	3.45	0	-	0.9	$\mu\text{s}$
Data set-up time	tSU;DAT	250	-	-	100	-	-	ns
Set-up time for STOP condition	tSU;STO	4.0	-	-	0.6	-	-	$\mu\text{s}$
Bus free time between a STOP and START condition	tBUF	4.7	-	-	1.3	-	-	$\mu\text{s}$

## ● Register List

Address	W/R	Register data								Function	
		D7	D6	D5	D4	D3	D2	D1	D0		
00h	W	-	-	-	-	-	-	-	-	SFTRST	Software Reset
01h	W	-	LED5MD(1)	LED5MD(0)	LED4MD	-	WPWMEN	ALCEN	MLEDMD		LED, ALC Control
02h	W	FLASHEN	TORCHEN	SLEDEN	MLEDEN	-	-	LDO2EN	LDO1EN		Power Control
03h	W	-	IMLED(6)	IMLED(5)	IMLED(4)	IMLED(3)	IMLED(2)	IMLED(1)	IMLED(0)		"Main Group" LED Current Setting at non-ALC mode
04h	W	-	ISLED(6)	ISLED(5)	ISLED(4)	ISLED(3)	ISLED(2)	ISLED(1)	ISLED(0)		"Sub Group" LED Current Setting
05h	W	-	-	-	IFTLED(4)	IFTLED(3)	IFTLED(2)	IFTLED(1)	IFTLED(0)		Flash LED "Torch mode" Current Setting
06h	W	-	-	-	IFFLED(4)	IFFLED(3)	IFFLED(2)	IFFLED(1)	IFFLED(0)		Flash LED "Flash mode" Current Setting
07h	W	LDO2VSEL(3)	LDO2VSEL(2)	LDO2VSEL(1)	LDO2VSEL(0)	LDO1VSEL(3)	LDO1VSEL(2)	LDO1VSEL(1)	LDO1VSEL(0)		LDO1, LDO2 Vout Setting
08h	W	THL(3)	THL(2)	THL(1)	THL(0)	TLH(3)	TLH(2)	TLH(1)	TLH(0)		Main Current transition
09h	-	-	-	-	-	-	-	-	-		-
0Ah	-	-	-	-	-	-	-	-	-		-
0Bh	W	ADCCYC(1)	ADCCYC(0)	GAIN(1)	GAIN(0)	STYPE	VSB	MDCIR	SBIASON		ALC mode setting
0Ch	W	SOFS(3)	SOFS(2)	SOFS(1)	SOFS(0)	SGAIN(3)	SGAIN(2)	SGAIN(1)	SGAIN(0)		ADC Data adjustment
0Dh	R	-	-	-	-	AMB(3)	AMB(2)	AMB(1)	AMB(0)		Ambient level
0Eh	W	-	IU0(6)	IU0(5)	IU0(4)	IU0(3)	IU0(2)	IU0(1)	IU0(0)		Main Current at Ambient level 0h
0Fh	W	-	IU1(6)	IU1(5)	IU1(4)	IU1(3)	IU1(2)	IU1(1)	IU1(0)		Main Current at Ambient level 1h
10h	W	-	IU2(6)	IU2(5)	IU2(4)	IU2(3)	IU2(2)	IU2(1)	IU2(0)		Main Current at Ambient level 2h
11h	W	-	IU3(6)	IU3(5)	IU3(4)	IU3(3)	IU3(2)	IU3(1)	IU3(0)		Main Current at Ambient level 3h
12h	W	-	IU4(6)	IU4(5)	IU4(4)	IU4(3)	IU4(2)	IU4(1)	IU4(0)		Main Current at Ambient level 4h
13h	W	-	IU5(6)	IU5(5)	IU5(4)	IU5(3)	IU5(2)	IU5(1)	IU5(0)		Main Current at Ambient level 5h
14h	W	-	IU6(6)	IU6(5)	IU6(4)	IU6(3)	IU6(2)	IU6(1)	IU6(0)		Main Current at Ambient level 6h
15h	W	-	IU7(6)	IU7(5)	IU7(4)	IU7(3)	IU7(2)	IU7(1)	IU7(0)		Main Current at Ambient level 7h
16h	W	-	IU8(6)	IU8(5)	IU8(4)	IU8(3)	IU8(2)	IU8(1)	IU8(0)		Main Current at Ambient level 8h
17h	W	-	IU9(6)	IU9(5)	IU9(4)	IU9(3)	IU9(2)	IU9(1)	IU9(0)		Main Current at Ambient level 9h
18h	W	-	IUA(6)	IUA(5)	IUA(4)	IUA(3)	IUA(2)	IUA(1)	IUA(0)		Main Current at Ambient level Ah
19h	W	-	IUB(6)	IUB(5)	IUB(4)	IUB(3)	IUB(2)	IUB(1)	IUB(0)		Main Current at Ambient level Bh
1Ah	W	-	IUC(6)	IUC(5)	IUC(4)	IUC(3)	IUC(2)	IUC(1)	IUC(0)		Main Current at Ambient level Ch
1Bh	W	-	IUD(6)	IUD(5)	IUD(4)	IUD(3)	IUD(2)	IUD(1)	IUD(0)		Main Current at Ambient level Dh
1Ch	W	-	IUE(6)	IUE(5)	IUE(4)	IUE(3)	IUE(2)	IUE(1)	IUE(0)		Main Current at Ambient level Eh
1Dh	W	-	IUF(6)	IUF(5)	IUF(4)	IUF(3)	IUF(2)	IUF(1)	IUF(0)		Main Current at Ambient level Fh

Input "0" for "-".

Prohibit to accessing the address that isn't mentioned.

The time indicated by register explanation is the TYP time made by dividing of the built-in OSC.

### ● Register Map

Address 00h < Software Reset >

Address	R/W	Bit7	Bit6	Bit5	Bit4	Bit3	Bit2	Bit1	Bit0
00h	W	-	-	-	-	-	-	-	SFTRST
Initial Value	00h	-	-	-	-	-	-	-	0

Bit [7:1] : (Not used)

Bit0 : **SFTRST** Software Reset Command  
 "0" : Reset cancel  
 "1" : Reset (All register initializing)  
 Refer to "The explanation of Reset" for detail.

Address 01h < LED, ALC Control >

Address	R/W	Bit7	Bit6	Bit5	Bit4	Bit3	Bit2	Bit1	Bit0
01h	W	-	LED5MD(1)	LED5MD(0)	LED4MD	-	WPWMEN	ALCEN	MLEDMD
Initial Value	00h	-	0	0	0	-	0	0	0

Bit7 : (Not used)

Bit [6:5] : **LED5MD(1:0)** LED5 Group Select (Main/Sub/OFF)  
 "00" : LED5 OFF  
 "01" : reserved  
 "10" : LED5 "Sub Group"  
 "11" : LED5 "Main Group"  
 Refer to "The explanation of LED Driver" for detail.

Bit4 : **LED4MD** LED4 Group Select (Main/Sub)  
 "0" : LED4 "Sub Group"  
 "1" : LED4 "Main Group"  
 Refer to "The explanation of LED Driver" for detail.

Bit3 : (Not used)

Bit2 : **WPWMEN** External PWM Input "WPWMIN" terminal Enable Control (Valid/Invalid)  
 "0" : WPWMIN input invalid  
 "1" : WPWMIN input valid  
 Refer to "(11) Current Adjustment" of "The explanation of ALC" for detail.

Bit1 : **ALCEN** ALC Function Control (ON/OFF)  
 "0" : ALC function OFF  
 "1" : ALC function ON  
 Refer to "(1) Auto Luminous Control ON/OFF" of "The explanation of ALC" for detail.

Bit0 : **MLEDMD** "Main Group" LED Mode Select (Non ALC / with ALC)  
 "0" : Non ALC mode  
 "1" : ALC mode  
 Refer to "(1) Auto Luminous Control ON/OFF" of "The explanation of ALC" for detail.

Address 02h &lt; Power Control &gt;

Address	R/W	Bit7	Bit6	Bit5	Bit4	Bit3	Bit2	Bit1	Bit0
02h	W	FLASHEN	TORCHEN	SLEDEN	MLEDEN	-	-	LDO2EN	LDO1EN
Initial Value	00h	0	0	0	0	-	-	0	0

Bit [7:6] : **FLASHEN, TORCHEN** LEDFL Control (Flash ON / Torch ON / OFF)

	(At FLASHCNT=L)	(At FLASHCNT=H)	"FLASHCNT" means external pin.
"00" :	LEDFL: OFF,	Flash mode ON	
"01" :	LEDFL: Torch mode ON,	Flash mode ON	
"10" :	LEDFL: Flash mode ON,	Flash mode ON	
"11" :	reserved		

For Torch/Flash, refer to "Flash LED Current Setting" (address 05h, 06h)

At FLASHCNT=H, even if RESETB=L, the Flash mode becomes ON, and LED is turned on.

But, the setup of LED current becomes the minimum setting in this case.

(Because the setting of LED current is reset at the time of RESETB=L.)

Refer to "The explanation of LED Driver" for detail.

Bit 5 : **SLEDEN** Sub Group LED Control (ON/OFF)

"0" : "Sub Group" LED OFF

"1" : "Sub Group" LED ON

Bit 4 : **MLEDEN** Main Group LED Control (ON/OFF)

"0" : "Main Group" LED OFF

"1" : "Main Group" LED ON

Bit [3:2] : (Not used)

Bit 1 : **LDO2EN** LDO2 Control (ON/OFF)

"0" : LDO2 OFF

"1" : LDO2 ON

Bit 0 : **LDO1EN** LDO1 Control (ON/OFF)

"0" : LDO1 OFF

"1" : LDO1 ON

Address 03h < "Main Group" LED Current Setting at non-ALC mode >

Address	R/W	Bit7	Bit6	Bit5	Bit4	Bit3	Bit2	Bit1	Bit0
03h	W	-	IMLED(6)	IMLED(5)	IMLED(4)	IMLED(3)	IMLED(2)	IMLED(1)	IMLED(0)
Initial Value	00h	-	0	0	0	0	0	0	0

Bit7 : (Not used)

Bit [6:0] : **IMLED(6:0)** Main Group LED Current Setting at non-ALC mode

"0000000" : 0.2 mA	"1000000" : 13.0 mA
"0000001" : 0.4 mA	"1000001" : 13.2 mA
"0000010" : 0.6 mA	"1000010" : 13.4 mA
"0000011" : 0.8 mA	"1000011" : 13.6 mA
"0000100" : 1.0 mA	"1000100" : 13.8 mA
"0000101" : 1.2 mA	"1000101" : 14.0 mA
"0000110" : 1.4 mA	"1000110" : 14.2 mA
"0000111" : 1.6 mA	"1000111" : 14.4 mA
"0001000" : 1.8 mA	"1001000" : 14.6 mA
"0001001" : 2.0 mA	"1001001" : 14.8 mA
"0001010" : 2.2 mA	"1001010" : 15.0 mA
"0001011" : 2.4 mA	"1001011" : 15.2 mA
"0001100" : 2.6 mA	"1001100" : 15.4 mA
"0001101" : 2.8 mA	"1001101" : 15.6 mA
"0001110" : 3.0 mA	"1001110" : 15.8 mA
"0001111" : 3.2 mA	"1001111" : 16.0 mA
"0010000" : 3.4 mA	"1010000" : 16.2 mA
"0010001" : 3.6 mA	"1010001" : 16.4 mA
"0010010" : 3.8 mA	"1010010" : 16.6 mA
"0010011" : 4.0 mA	"1010011" : 16.8 mA
"0010100" : 4.2 mA	"1010100" : 17.0 mA
"0010101" : 4.4 mA	"1010101" : 17.2 mA
"0010110" : 4.6 mA	"1010110" : 17.4 mA
"0010111" : 4.8 mA	"1010111" : 17.6 mA
"0011000" : 5.0 mA	"1011000" : 17.8 mA
"0011001" : 5.2 mA	"1011001" : 18.0 mA
"0011010" : 5.4 mA	"1011010" : 18.2 mA
"0011011" : 5.6 mA	"1011011" : 18.4 mA
"0011100" : 5.8 mA	"1011100" : 18.6 mA
"0011101" : 6.0 mA	"1011101" : 18.8 mA
"0011110" : 6.2 mA	"1011110" : 19.0 mA
"0011111" : 6.4 mA	"1011111" : 19.2 mA
"0100000" : 6.6 mA	"1100000" : 19.4 mA
"0100001" : 6.8 mA	"1100001" : 19.6 mA
"0100010" : 7.0 mA	"1100010" : 19.8 mA
"0100011" : 7.2 mA	"1100011" : 20.0 mA
"0100100" : 7.4 mA	"1100100" : 20.2 mA
"0100101" : 7.6 mA	"1100101" : 20.4 mA
"0100110" : 7.8 mA	"1100110" : 20.6 mA
"0100111" : 8.0 mA	"1100111" : 20.8 mA
"0101000" : 8.2 mA	"1101000" : 21.0 mA
"0101001" : 8.4 mA	"1101001" : 21.2 mA
"0101010" : 8.6 mA	"1101010" : 21.4 mA
"0101011" : 8.8 mA	"1101011" : 21.6 mA
"0101100" : 9.0 mA	"1101100" : 21.8 mA
"0101101" : 9.2 mA	"1101101" : 22.0 mA
"0101110" : 9.4 mA	"1101110" : 22.2 mA
"0101111" : 9.6 mA	"1101111" : 22.4 mA
"0110000" : 9.8 mA	"1110000" : 22.6 mA
"0110001" : 10.0 mA	"1110001" : 22.8 mA
"0110010" : 10.2 mA	"1110010" : 23.0 mA
"0110011" : 10.4 mA	"1110011" : 23.2 mA
"0110100" : 10.6 mA	"1110100" : 23.4 mA
"0110101" : 10.8 mA	"1110101" : 23.6 mA
"0110110" : 11.0 mA	"1110110" : 23.8 mA
"0110111" : 11.2 mA	"1110111" : 24.0 mA
"0111000" : 11.4 mA	"1111000" : 24.2 mA
"0111001" : 11.6 mA	"1111001" : 24.4 mA
"0111010" : 11.8 mA	"1111010" : 24.6 mA
"0111011" : 12.0 mA	"1111011" : 24.8 mA
"0111100" : 12.2 mA	"1111100" : 25.0 mA
"0111101" : 12.4 mA	"1111101" : 25.2 mA
"0111110" : 12.6 mA	"1111110" : 25.4 mA
"0111111" : 12.8 mA	"1111111" : 25.6 mA

Address 04h &lt; "Sub Group" LED Current Setting &gt;

Address	R/W	Bit7	Bit6	Bit5	Bit4	Bit3	Bit2	Bit1	Bit0
04h	W	-	ISLED(6)	ISLED(5)	ISLED(4)	ISLED(3)	ISLED(2)	ISLED(1)	ISLED(0)
Initial Value	00h	-	0	0	0	0	0	0	0

Bit7 : (Not used)

Bit [6:0] : **ISLED(6:0)** Sub Group LED Current Setting

"0000000" : 0.2 mA	"1000000" : 13.0 mA
"0000001" : 0.4 mA	"1000001" : 13.2 mA
"0000010" : 0.6 mA	"1000010" : 13.4 mA
"0000011" : 0.8 mA	"1000011" : 13.6 mA
"0000100" : 1.0 mA	"1000100" : 13.8 mA
"0000101" : 1.2 mA	"1000101" : 14.0 mA
"0000110" : 1.4 mA	"1000110" : 14.2 mA
"0000111" : 1.6 mA	"1000111" : 14.4 mA
"0001000" : 1.8 mA	"1001000" : 14.6 mA
"0001001" : 2.0 mA	"1001001" : 14.8 mA
"0001010" : 2.2 mA	"1001010" : 15.0 mA
"0001011" : 2.4 mA	"1001011" : 15.2 mA
"0001100" : 2.6 mA	"1001100" : 15.4 mA
"0001101" : 2.8 mA	"1001101" : 15.6 mA
"0001110" : 3.0 mA	"1001110" : 15.8 mA
"0001111" : 3.2 mA	"1001111" : 16.0 mA
"0010000" : 3.4 mA	"1010000" : 16.2 mA
"0010001" : 3.6 mA	"1010001" : 16.4 mA
"0010010" : 3.8 mA	"1010010" : 16.6 mA
"0010011" : 4.0 mA	"1010011" : 16.8 mA
"0010100" : 4.2 mA	"1010100" : 17.0 mA
"0010101" : 4.4 mA	"1010101" : 17.2 mA
"0010110" : 4.6 mA	"1010110" : 17.4 mA
"0010111" : 4.8 mA	"1010111" : 17.6 mA
"0011000" : 5.0 mA	"1011000" : 17.8 mA
"0011001" : 5.2 mA	"1011001" : 18.0 mA
"0011010" : 5.4 mA	"1011010" : 18.2 mA
"0011011" : 5.6 mA	"1011011" : 18.4 mA
"0011100" : 5.8 mA	"1011100" : 18.6 mA
"0011101" : 6.0 mA	"1011101" : 18.8 mA
"0011110" : 6.2 mA	"1011110" : 19.0 mA
"0011111" : 6.4 mA	"1011111" : 19.2 mA
"0100000" : 6.6 mA	"1100000" : 19.4 mA
"0100001" : 6.8 mA	"1100001" : 19.6 mA
"0100010" : 7.0 mA	"1100010" : 19.8 mA
"0100011" : 7.2 mA	"1100011" : 20.0 mA
"0100100" : 7.4 mA	"1100100" : 20.2 mA
"0100101" : 7.6 mA	"1100101" : 20.4 mA
"0100110" : 7.8 mA	"1100110" : 20.6 mA
"0100111" : 8.0 mA	"1100111" : 20.8 mA
"0101000" : 8.2 mA	"1101000" : 21.0 mA
"0101001" : 8.4 mA	"1101001" : 21.2 mA
"0101010" : 8.6 mA	"1101010" : 21.4 mA
"0101011" : 8.8 mA	"1101011" : 21.6 mA
"0101100" : 9.0 mA	"1101100" : 21.8 mA
"0101101" : 9.2 mA	"1101101" : 22.0 mA
"0101110" : 9.4 mA	"1101110" : 22.2 mA
"0101111" : 9.6 mA	"1101111" : 22.4 mA
"0110000" : 9.8 mA	"1110000" : 22.6 mA
"0110001" : 10.0 mA	"1110001" : 22.8 mA
"0110010" : 10.2 mA	"1110010" : 23.0 mA
"0110011" : 10.4 mA	"1110011" : 23.2 mA
"0110100" : 10.6 mA	"1110100" : 23.4 mA
"0110101" : 10.8 mA	"1110101" : 23.6 mA
"0110110" : 11.0 mA	"1110110" : 23.8 mA
"0110111" : 11.2 mA	"1110111" : 24.0 mA
"0111000" : 11.4 mA	"1111000" : 24.2 mA
"0111001" : 11.6 mA	"1111001" : 24.4 mA
"0111010" : 11.8 mA	"1111010" : 24.6 mA
"0111011" : 12.0 mA	"1111011" : 24.8 mA
"0111100" : 12.2 mA	"1111100" : 25.0 mA
"0111101" : 12.4 mA	"1111101" : 25.2 mA
"0111110" : 12.6 mA	"1111110" : 25.4 mA
"0111111" : 12.8 mA	"1111111" : 25.6 mA

Address 05h < Flash LED "Torch mode" Current Setting >

Address	R/W	Bit7	Bit6	Bit5	Bit4	Bit3	Bit2	Bit1	Bit0
05h	W	-	-	-	IFTLED(4)	IFTLED(3)	IFTLED(2)	IFTLED(1)	IFTLED(0)
Initial Value	00h	-	-	-	0	0	0	0	0

Bit [7:5] : (Not used)

Bit [4:0] : **IFTLED(4:0)** "Torch mode" of LEDFL Current Setting

"00000"	: 3.75 mA	(Initial value)
"00001"	: 7.50 mA	
"00010"	: 11.25 mA	
"00011"	: 15.00 mA	
"00100"	: 18.75 mA	
"00101"	: 22.50 mA	
"00110"	: 26.25 mA	
"00111"	: 30.00 mA	
"01000"	: 33.75 mA	
"01001"	: 37.50 mA	
"01010"	: 41.25 mA	
"01011"	: 45.00 mA	
"01100"	: 48.75 mA	
"01101"	: 52.50 mA	
"01110"	: 56.25 mA	
"01111"	: 60.00 mA	
"10000"	: 63.75 mA	
"10001"	: 67.50 mA	
"10010"	: 71.25 mA	
"10011"	: 75.00 mA	
"10100"	: 78.75 mA	
"10101"	: 82.50 mA	
"10110"	: 86.25 mA	
"10111"	: 90.00 mA	
"11000"	: 93.75 mA	
"11001"	: 97.50 mA	
"11010"	: 101.25 mA	
"11011"	: 105.00 mA	
"11100"	: 108.75 mA	
"11101"	: 112.50 mA	
"11110"	: 116.25 mA	
"11111"	: 120.00 mA	

\* LED Current : 120 x 1/32 mA Step (=3.75 mA Step)

Address 06h < Flash LED "Flash mode" Current Setting >

Address	R/W	Bit7	Bit6	Bit5	Bit4	Bit3	Bit2	Bit1	Bit0
06h	W	-	-	-	IFFLED(4)	IFFLED(3)	IFFLED(2)	IFFLED(1)	IFFLED(0)
Initial Value	00h	-	-	-	0	0	0	0	0

Bit [7:5] : (Not used)

Bit [4:0] : **IFFLED(4:0)** "Flash mode" of LEDFL Current Setting

"00000"	: 3.75 mA	(Initial value)
"00001"	: 7.50 mA	
"00010"	: 11.25 mA	
"00011"	: 15.00 mA	
"00100"	: 18.75 mA	
"00101"	: 22.50 mA	
"00110"	: 26.25 mA	
"00111"	: 30.00 mA	
"01000"	: 33.75 mA	
"01001"	: 37.50 mA	
"01010"	: 41.25 mA	
"01011"	: 45.00 mA	
"01100"	: 48.75 mA	
"01101"	: 52.50 mA	
"01110"	: 56.25 mA	
"01111"	: 60.00 mA	
"10000"	: 63.75 mA	
"10001"	: 67.50 mA	
"10010"	: 71.25 mA	
"10011"	: 75.00 mA	
"10100"	: 78.75 mA	
"10101"	: 82.50 mA	
"10110"	: 86.25 mA	
"10111"	: 90.00 mA	
"11000"	: 93.75 mA	
"11001"	: 97.50 mA	
"11010"	: 101.25 mA	
"11011"	: 105.00 mA	
"11100"	: 108.75 mA	
"11101"	: 112.50 mA	
"11110"	: 116.25 mA	
"11111"	: 120.00 mA	

\* LED Current : 120 x 1/32 mA Step (=3.75 mA Step)

Address 07h &lt; LDO1 Vout Control, LDO2 Vout Control &gt;

Address	R/W	Bit7	Bit6	Bit5	Bit4	Bit3	Bit2	Bit1	Bit0
07h	W	LDO2VSEL(3)	LDO2VSEL(2)	LDO2VSEL(1)	LDO2VSEL(0)	LDO1VSEL(3)	LDO1VSEL(2)	LDO1VSEL(1)	LDO1VSEL(0)
Initial Value	74h	0	1	1	1	0	1	0	0

Bit [7:4] : **LDO2VSEL(3:0)** LDO2 Output Voltage Control

"0000"	: 1.20 V	
"0001"	: 1.30 V	
"0010"	: 1.50 V	
"0011"	: 1.60 V	
"0100"	: 1.80 V	
"0101"	: 2.20 V	
"0110"	: 2.40 V	
"0111"	: 2.50 V	(Initial value)
"1000"	: 2.60 V	
"1001"	: 2.70 V	
"1010"	: 2.80 V	
"1011"	: 2.90 V	
"1100"	: 3.00 V	
"1101"	: 3.10 V	
"1110"	: 3.20 V	
"1111"	: 3.30 V	

Bit [3:0] : **LDO1VSEL(3:0)** LDO1 Output Voltage Control

"0000"	: 1.20 V	
"0001"	: 1.30 V	
"0010"	: 1.50 V	
"0011"	: 1.60 V	
"0100"	: 1.80 V	(Initial value)
"0101"	: 2.20 V	
"0110"	: 2.40 V	
"0111"	: 2.50 V	
"1000"	: 2.60 V	
"1001"	: 2.70 V	
"1010"	: 2.80 V	
"1011"	: 2.90 V	
"1100"	: 3.00 V	
"1101"	: 3.10 V	
"1110"	: 3.20 V	
"1111"	: 3.30 V	

Address 08h &lt; Main Current transition &gt;

Address	R/W	Bit7	Bit6	Bit5	Bit4	Bit3	Bit2	Bit1	Bit0
08h	W	THL(3)	THL(2)	THL(1)	THL(0)	TLH(3)	TLH(2)	TLH(1)	TLH(0)
Initial Value	C7h	1	1	0	0	0	1	1	1

Bit [7:4] : **THL(3:0)** Main LED current Down transition per 0.2mA step

"0000" :	0.256 ms
"0001" :	0.512 ms
"0010" :	1.024 ms
"0011" :	2.048 ms
"0100" :	4.096 ms
"0101" :	8.192 ms
"0110" :	16.38 ms
"0111" :	32.77 ms
"1000" :	65.54 ms
"1001" :	131.1 ms
"1010" :	196.6 ms
"1011" :	262.1 ms
"1100" :	327.7 ms (Initial value)
"1101" :	393.2 ms
"1110" :	458.8 ms
"1111" :	524.3 ms

Setting time is counted based on the switching frequency of Charge Pump.

The above value becomes the value of the Typ (1MHz) time.

Refer to "(9) Slope Process" of "The explanation of ALC" for detail.

Bit [3:0] : **TLH(3:0)** Main LED current Up transition per 0.2mA step

"0000" :	0.256 ms
"0001" :	0.512 ms
"0010" :	1.024 ms
"0011" :	2.048 ms
"0100" :	4.096 ms
"0101" :	8.192 ms
"0110" :	16.38 ms
"0111" :	32.77 ms (Initial value)
"1000" :	65.54 ms
"1001" :	131.1 ms
"1010" :	196.6 ms
"1011" :	262.1 ms
"1100" :	327.7 ms
"1101" :	393.2 ms
"1110" :	458.8 ms
"1111" :	524.3 ms

Setting time is counted based on the switching frequency of Charge Pump.

The above value becomes the value of the Typ (1MHz) time.

Refer to "(9) Slope Process" of "The explanation of ALC" for detail.

Address 0Bh &lt; ALC mode setting &gt;

Address	R/W	Bit7	Bit6	Bit5	Bit4	Bit3	Bit2	Bit1	Bit0
0Bh	W	ADCYC(1)	ADCYC(0)	GAIN(1)	GAIN(0)	STYPE	VSB	MDCIR	SBIASON
Initial Value	81h	1	0	0	0	0	0	0	1

Bit [7:6] : **ADCYC(1:0)** ADC Measurement Cycle

- "00" : 0.52 s
- "01" : 1.05 s
- "10" : 1.57 s (Initial value)
- "11" : 2.10 s

Refer to "(4) A/D conversion" of "The explanation of ALC" for detail.

Bit [5:4] : **GAIN(1:0)** Sensor Gain Switching Function Control (This is effective only at STYPE="0".)

- "00" : Auto Change (Initial value)
- "01" : High
- "10" : Low
- "11" : Fixed

Refer to "(3) Gain control" of "The explanation of ALC" for detail.

Bit3 : **STYPE** Ambient Light Sensor Type Select (Linear/Logarithm)

- "0" : For Linear sensor (Initial value)
- "1" : For Log sensor

Refer to "(7) Ambient level detection" of "The explanation of ALC" for detail.

Bit2 : **VSB** SBIAS Output Voltage Control

- "0" : SBIAS output voltage 3.0V (Initial value)
- "1" : SBIAS output voltage 2.6V

Refer to "(2) I/V conversion" of "The explanation of ALC" for detail.

Bit1 : **MDCIR** LED Current Reset Select by Mode Change

- "0" : LED current non-reset when mode change (Initial value)
- "1" : LED current reset when mode change

Refer to "(10) LED current reset when mode change" of "The explanation of ALC" for detail.

Bit0 : **SBIASON** SBIAS Control (ON/OFF)

- "0" : Measurement cycle synchronous
- "1" : Usually ON (at ALCEN=1) (Initial value)

Refer to "(4) A/D conversion" of "The explanation of ALC" for detail.

Address 0Ch < ADC Data adjustment >

Address	R/W	Bit7	Bit6	Bit5	Bit4	Bit3	Bit2	Bit1	Bit0
0Ch	W	SOFS(3)	SOFS(2)	SOFS(1)	SOFS(0)	SGAIN(3)	SGAIN(2)	SGAIN(1)	SGAIN(0)
Initial Value	00h	0	0	0	0	0	0	0	0

Bit [7:4] : **SOFS(3:0)** AD Data Offset Adjustment

"1000" :	-8 LSB
"1001" :	-7 LSB
"1010" :	-6 LSB
"1011" :	-5 LSB
"1100" :	-4 LSB
"1101" :	-3 LSB
"1110" :	-2 LSB
"1111" :	-1 LSB
"0000" :	non-adjust
"0001" :	+1 LSB
"0010" :	+2 LSB
"0011" :	+3 LSB
"0100" :	+4 LSB
"0101" :	+5 LSB
"0110" :	+6 LSB
"0111" :	+7 LSB

Offset adjust is performed to ADC data.

Refer to "(5) ADC data Gain/offset adjustment" of "The explanation of ALC" for detail.

Bit [3:0] : **SGAIN(3:0)** AD Data Gain Adjustment

"1000" :	reserved
"1001" :	reserved
"1010" :	-37.50%
"1011" :	-31.25%
"1100" :	-25.00%
"1101" :	-18.75%
"1110" :	-12.50%
"1111" :	-6.25%
"0000" :	non-adjust
"0001" :	+6.25%
"0010" :	+12.50%
"0011" :	+18.75%
"0100" :	+25.00%
"0101" :	+31.25%
"0110" :	+37.50%
"0111" :	reserved

Gain adjust is performed to ADC data.

The data after adjustment are round off by 8-bit data.

Refer to "(5) ADC data Gain/offset adjustment" of "The explanation of ALC" for detail.

Address 0Dh < Ambient level (Read Only) >

Address	R/W	Bit7	Bit6	Bit5	Bit4	Bit3	Bit2	Bit1	Bit0
0Dh	R	-	-	-	-	AMB(3)	AMB(2)	AMB(1)	AMB(0)
Initial Value	-	-	-	-	-	-	-	-	-

Bit [7:4] : (Not used)

Bit [3:0] : **AMB(3:0)** Ambient Level

"0000" : 0h

"0001" : 1h

"0010" : 2h

"0011" : 3h

"0100" : 4h

"0101" : 5h

"0110" : 6h

"0111" : 7h

"1000" : 8h

"1001" : 9h

"1010" : Ah

"1011" : Bh

"1100" : Ch

"1101" : Dh

"1110" : Eh

"1111" : Fh

The data can be read through I<sup>2</sup>C.

Refer to "(7) Ambient level detection" of "The explanation of ALC" for detail.

Address 0Eh~1Dh &lt; Main Current at Ambient level 0h~Fh &gt;

Address	R/W	Bit7	Bit6	Bit5	Bit4	Bit3	Bit2	Bit1	Bit0
0Eh~1Dh	W	-	IU*(6)	IU*(5)	IU*(4)	IU*(3)	IU*(2)	IU*(1)	IU*(0)
Initial Value	-	Refer to after page for initial table.							

“\*\*” means 0~F.

Bit7 : (Not used)

Bit [6:0] : **IU\*(6:0)** Main Current at Ambient Level for 0h~Fh

“0000000” : 0.2 mA	“1000000” : 13.0 mA
“0000001” : 0.4 mA	“1000001” : 13.2 mA
“0000010” : 0.6 mA	“1000010” : 13.4 mA
“0000011” : 0.8 mA	“1000011” : 13.6 mA
“0000100” : 1.0 mA	“1000100” : 13.8 mA
“0000101” : 1.2 mA	“1000101” : 14.0 mA
“0000110” : 1.4 mA	“1000110” : 14.2 mA
“0000111” : 1.6 mA	“1000111” : 14.4 mA
“0001000” : 1.8 mA	“1001000” : 14.6 mA
“0001001” : 2.0 mA	“1001001” : 14.8 mA
“0001010” : 2.2 mA	“1001010” : 15.0 mA
“0001011” : 2.4 mA	“1001011” : 15.2 mA
“0001100” : 2.6 mA	“1001100” : 15.4 mA
“0001101” : 2.8 mA	“1001101” : 15.6 mA
“0001110” : 3.0 mA	“1001110” : 15.8 mA
“0001111” : 3.2 mA	“1001111” : 16.0 mA
“0010000” : 3.4 mA	“1010000” : 16.2 mA
“0010001” : 3.6 mA	“1010001” : 16.4 mA
“0010010” : 3.8 mA	“1010010” : 16.6 mA
“0010011” : 4.0 mA	“1010011” : 16.8 mA
“0010100” : 4.2 mA	“1010100” : 17.0 mA
“0010101” : 4.4 mA	“1010101” : 17.2 mA
“0010110” : 4.6 mA	“1010110” : 17.4 mA
“0010111” : 4.8 mA	“1010111” : 17.6 mA
“0011000” : 5.0 mA	“1011000” : 17.8 mA
“0011001” : 5.2 mA	“1011001” : 18.0 mA
“0011010” : 5.4 mA	“1011010” : 18.2 mA
“0011011” : 5.6 mA	“1011011” : 18.4 mA
“0011100” : 5.8 mA	“1011100” : 18.6 mA
“0011101” : 6.0 mA	“1011101” : 18.8 mA
“0011110” : 6.2 mA	“1011110” : 19.0 mA
“0011111” : 6.4 mA	“1011111” : 19.2 mA
“0100000” : 6.6 mA	“1100000” : 19.4 mA
“0100001” : 6.8 mA	“1100001” : 19.6 mA
“0100010” : 7.0 mA	“1100010” : 19.8 mA
“0100011” : 7.2 mA	“1100011” : 20.0 mA
“0100100” : 7.4 mA	“1100100” : 20.2 mA
“0100101” : 7.6 mA	“1100101” : 20.4 mA
“0100110” : 7.8 mA	“1100110” : 20.6 mA
“0100111” : 8.0 mA	“1100111” : 20.8 mA
“0101000” : 8.2 mA	“1101000” : 21.0 mA
“0101001” : 8.4 mA	“1101001” : 21.2 mA
“0101010” : 8.6 mA	“1101010” : 21.4 mA
“0101011” : 8.8 mA	“1101011” : 21.6 mA
“0101100” : 9.0 mA	“1101100” : 21.8 mA
“0101101” : 9.2 mA	“1101101” : 22.0 mA
“0101110” : 9.4 mA	“1101110” : 22.2 mA
“0101111” : 9.6 mA	“1101111” : 22.4 mA
“0110000” : 9.8 mA	“1110000” : 22.6 mA
“0110001” : 10.0 mA	“1110001” : 22.8 mA
“0110010” : 10.2 mA	“1110010” : 23.0 mA
“0110011” : 10.4 mA	“1110011” : 23.2 mA
“0110100” : 10.6 mA	“1110100” : 23.4 mA
“0110101” : 10.8 mA	“1110101” : 23.6 mA
“0110110” : 11.0 mA	“1110110” : 23.8 mA
“0110111” : 11.2 mA	“1110111” : 24.0 mA
“0111000” : 11.4 mA	“1111000” : 24.2 mA
“0111001” : 11.6 mA	“1111001” : 24.4 mA
“0111010” : 11.8 mA	“1111010” : 24.6 mA
“0111011” : 12.0 mA	“1111011” : 24.8 mA
“0111100” : 12.2 mA	“1111100” : 25.0 mA
“0111101” : 12.4 mA	“1111101” : 25.2 mA
“0111110” : 12.6 mA	“1111110” : 25.4 mA
“0111111” : 12.8 mA	“1111111” : 25.6 mA

## ● Explanation for operate

### 1. The explanation of Reset

There are two kinds of reset, software reset and hardware reset.

#### ● Software reset

- All the registers are initialized by SFTRST="1".
- SFTRST is an automatically returned to "0". (Auto Return 0).

#### ● Hardware reset

- It shifts to hardware reset by changing RESETB pin "H" → "L".
- The condition of all the registers under hardware reset pin is returned to the initial value, and it stops accepting all address.
- It's possible to release from a state of hardware reset by changing RESETB pin "L" → "H".
- RESETB pin has delay circuit. It doesn't recognize as hardware reset in "L" period under 5 $\mu$ s.
- Even if RESETB=L, at FLASHCNT=H, Flash mode becomes ON by minimum setting.

#### ● Reset Sequence

- When hardware reset was done during software reset, software reset is canceled when hardware reset is canceled. (Because the initial value of software reset is "0")

### 2. The explanation of Thermal shutdown

The blocks which thermal shutdown function is effective in the following.

Charge pump  
LED Driver  
LDO1, LDO2, SBIAS

A thermal shutdown function works in about 190°C.

Detection temperature has a hysteresis, and detection release temperature is about 170°C. (Design reference value)

### 3. The explanation of Charge Pump for LED driver

Charge Pump block is designed for the power supply for LED driver.

It has the x1.0/x1.33/x1.5/x2.0 mode. It changes to the most suitable mode automatically by  $V_f$  of LED and the battery voltage. It has the mode of x1.33 and it can be higher efficiency than traditional.

#### ● Start

Charge Pump circuit operates when any LED turns ON.

#### ● Soft start

When the start of the Charge Pump circuit is done, it has the soft start function to prevent a rush current.

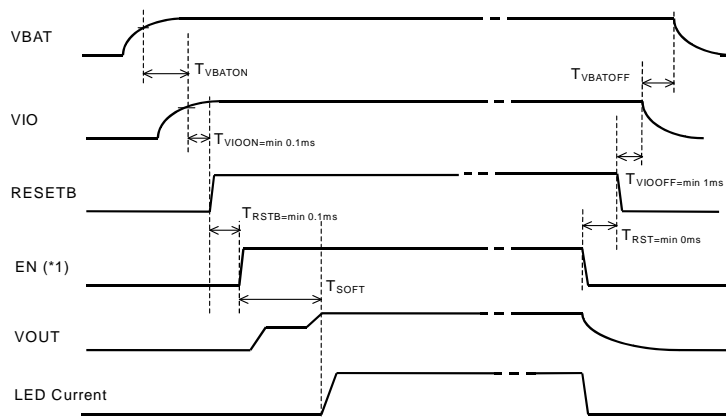

(\*1) An EN signal in the upper figure means the following:  
"EN is high" = Any LED turns ON  
But if  $T_a > T_{SD}$ , EN Signal doesn't become effective.

### ●Charge Pump Mode transition

The transition of boost multiple transits automatically by Vf of LED and the battery voltage.

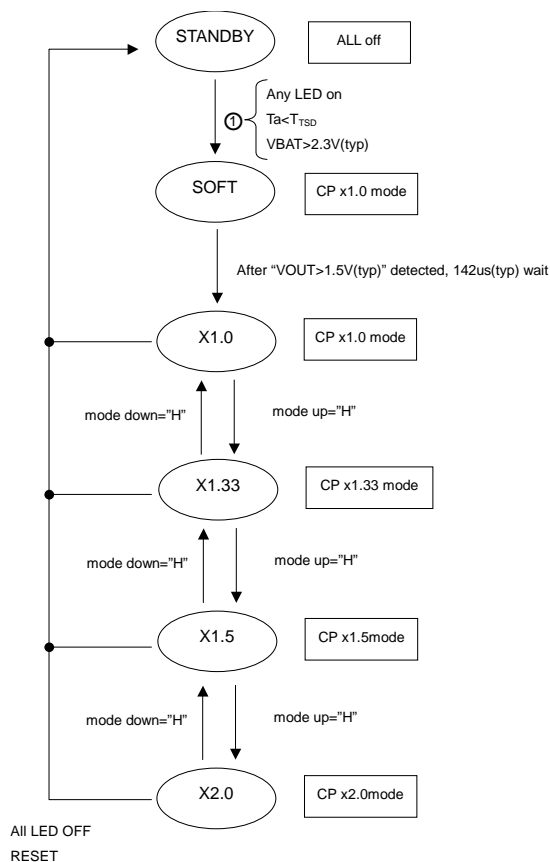

BD6095GUL/BD6095GU changes the four charge pump movement mode automatically to realize low consumption power.

#### < Mode Up >

A LED terminal voltage is monitored, and the movement mode is changed to  $x1 \rightarrow x1.33$ ,  $x1.33 \rightarrow x1.5$  and  $x1.5 \rightarrow x2$  automatically when a LED terminal voltage is lower than 0.2V (typ).

At this time, the maximum output voltage of the charge pump is restricted to 5.1V (typ).

#### < Mode Down >

The rise in the battery voltage, the off control of LED lighting, "Main Group" LED current value and the data writing to the address 04h,05h,06h (LED Current Setting) is monitored, and the movement mode is changed to  $x2 \rightarrow x1.5 \rightarrow x1.33 \rightarrow x1$  automatically.

This mode down movement lasts until a mode up movement happens.

At Flash mode and Torch mode, the mode down doesn't happen.

The thresholds of rise in a battery voltage are 2.9V, 3.3V, 3.7V and 4.1V (typ).

And, as for the off control of LED lighting, it is shown that MLEDEN, SLEDEN, TORCHEN, FLASHEN and FLASHCNT transited in "1"  $\rightarrow$  "0".

### ●Over Voltage protection / Over Current protection

Charge Pump circuit output (VOUT) is equipped with the over-voltage protection and the over current protection function. A VOUT over-voltage detection voltage is about 5.5V(typ). (VOUT at the time of rise in a voltage)

A detection voltage has a hysteresis, and a detection release voltage is about 5.1V(typ).

And, when VOUT output short to ground, input current of the battery terminal is limited by an over current protection function.

4. The explanation of LED Driver

●LED1~LED3

LED1~LED3 are same controlled. These are using for "Main backlight" and we call it "Main Group".

Current setting: IMLED(6:0)  
ON/OFF: MLEDEN (ON=1, OFF=0)

●LED4~LED5

LED4 and LED5 can be independent controlled. There are attributed to "Main Group" or "Sub Group".

If these are attributed to "Main Group", these are controlled by same as LED1~LED3.

<Independent Control>

Current setting: ISLED(6:0)  
ON/OFF: SLEDEN (ON=1, OFF=0)

<Attribute to "Main Group">

Current setting: IMLED(6:0)  
ON/OFF: MLEDEN (ON=1, OFF=0)

●The number of LED Lighting (LED1~LED5)

The number of lighting for Main/Sub LED can be set up grouping by the register

The setting of the number of lighting is as the following.

The Main/Sub LED is independently controlled by register MLEDEN, SLEDEN.

LED5MD(1)	LED5MD(0)	LED4MD	LED1	LED2	LED3	LED4	LED5	Main/Sub Setting Example
0	0	0	Main	Main	Main	Sub	OFF	3 / 0 , 3 / 1
0	0	1	Main	Main	Main	Main	OFF	4 / 0
1	0	0	Main	Main	Main	Sub	Sub	3 / 0 , 3 / 2
1	0	1	Main	Main	Main	Main	Sub	4 / 0 , 4 / 1
1	1	0	Main	Main	Main	Sub	Main	4 / 0 , 4 / 1
1	1	1	Main	Main	Main	Main	Main	5 / 0

The change of the Grouping setting with turning it on is prohibited.  
The LED terminal that isn't used must be connected to the ground.

●LEDFL

LEDFL is for Flash. It has the two mode, "Torch" and "Flash".

Torch mode current: IFTLED(4:0)

Flash mode current: IFFLED(4:0)

ON/OFF: TORCHEN, FLASHEN, FLASHCNT (refer to "Power Control" address 02h)

Flash mode is started by the rise edge of FLASHEN or FLASHCNT.

At FLASHCNT=H, even if RESETB=L, the Flash mode becomes ON, and LED is turned on.

(But, the setup of LED current becomes the minimum setting in this case because current setting is reset.)

Please set FLASHCNT=L when you don't turn on Flash.

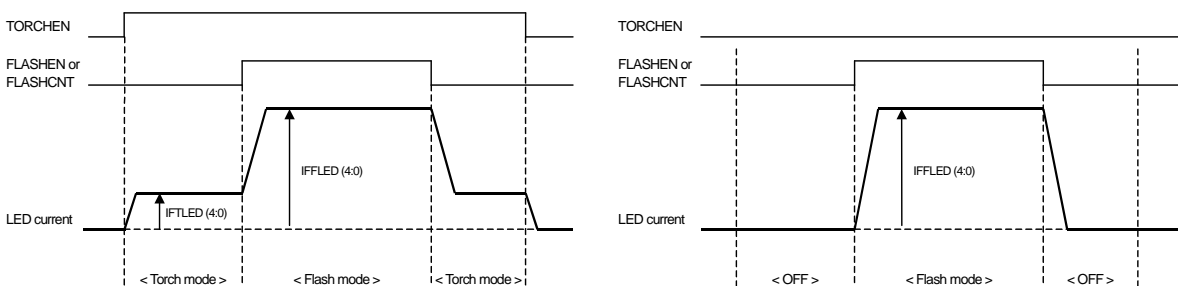

**5. The explanation of ALC (Auto Luminous Control)**

- LCD backlight current adjustment is possible in the basis of the data detected by external ambient light sensor.
- Extensive selection of the ambient light sensors (Photo Diode, Photo Transistor, Photo IC(linear/logarithm)) is possible by building adjustment feature of Sensor bias, gain adjustment and offset adjustment.
  - Ambient data is changed into ambient level by digital data processing, and it can be read through I<sup>2</sup>C I/F.
  - Register setting can customize a conversion to LED current. (Initial value is pre-set.)
  - Natural dimming of LED driver is possible with the adjustment of the current transition speed.

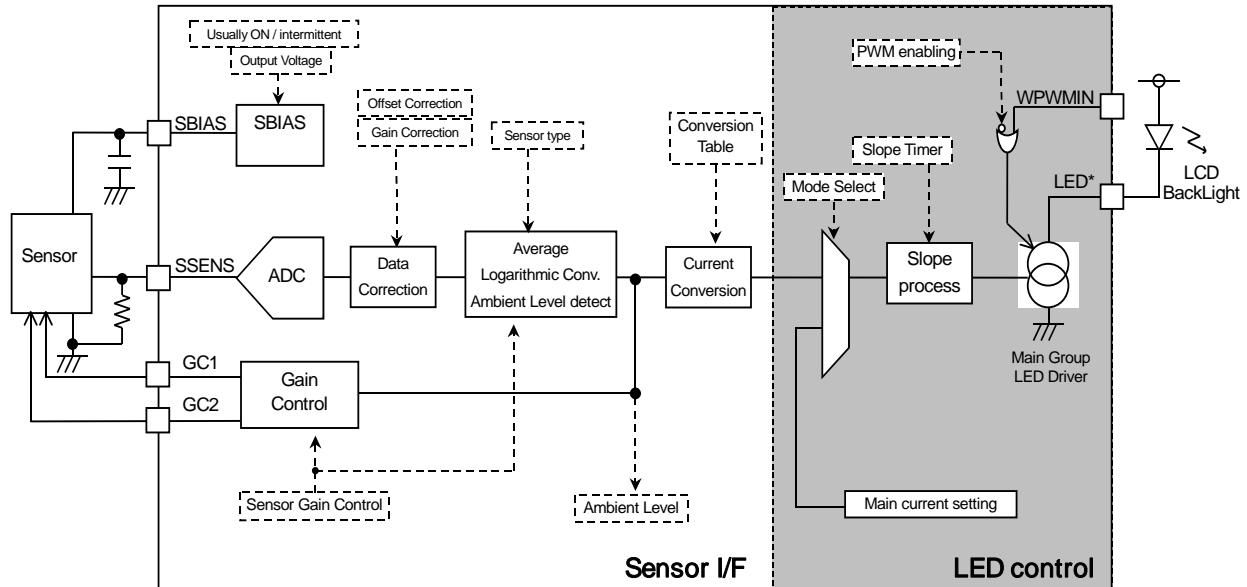

\* Wave form in this explanation just shows operation image, not shows absolute value precisely.

**(1) Auto Luminous Control ON/OFF**

- ALC block can be independent setting ON/OFF.
- It can use only to measure the Ambient level.  
Register : ALCEN  
Register : MLEDEN  
Register : MLEDMD
- Refer to under about the associate ALC mode and Main LED current.

ALCEN	MLEDEN	MLEDMD	Sensor I/F	LED control	Mode	Main LED current
0	0	x	OFF ( AMB(3:0)=0h )	OFF	OFF	-
0	1	0		ON	Non ALC mode	IMLED(6:0)
0	1	1		ON	Non ALC mode	IU0(6:0) (*1)
1	0	x	ON	OFF	ALC mode	-
1	1	0		ON		IMLED(6:0)
1	1	1		ON		ALC mode (*2)

(\*1) At this mode, because Sensor I/F is OFF, AMB(3:0)=0h.  
So, Main LED current is selected IU0(6:0).

(\*2) At this mode, Main LED current is selected IU0(6:0)~IUF(6:0)  
It becomes current value corresponding to each brightness.

(2) I/V conversion

- The bias voltage and external resistance for the I-V conversion ( $R_s$ ) are adjusted with adaptation of sensor characteristic
- The bias voltage is selectable by register setup.

Register : VSB

“0” : SBIAS output voltage 3.0V

“1” : SBIAS output voltage 2.6V

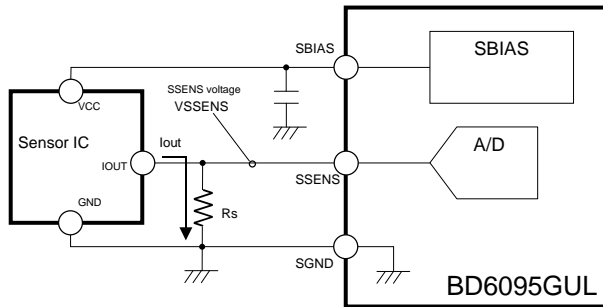

$R_s$  : Sense resistance (A sensor output current is changed into the voltage value.)

SBIAS : Bias power supply terminal for the sensor (3.0V / 2.6V by register setting)

SSENS : Sense voltage input terminal

$$\text{SSENS Voltage} = I_{\text{out}} \times R_s$$

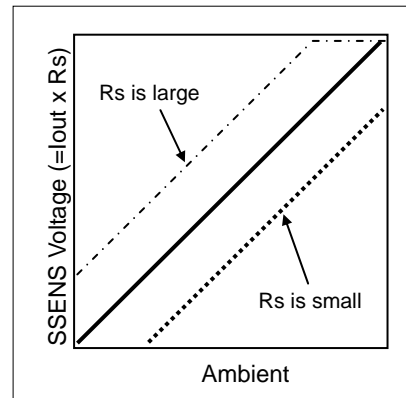
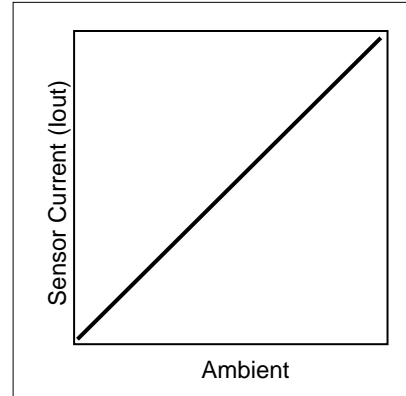

(3) Gain control

- Sensor gain switching function is built in to extend the dynamic range.
- It is controlled by register setup.
- When automatic gain control is off, the gain status can be set up in the manual.
- Register : GAIN(1:0)
- GC1 and GC2 are outputted corresponding to each gain status.

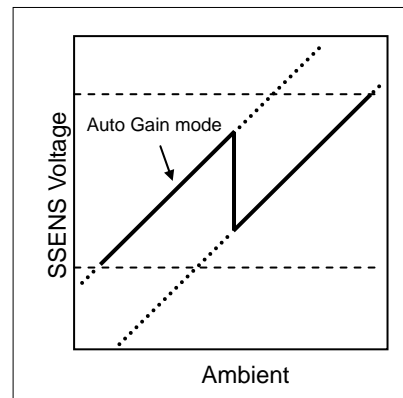
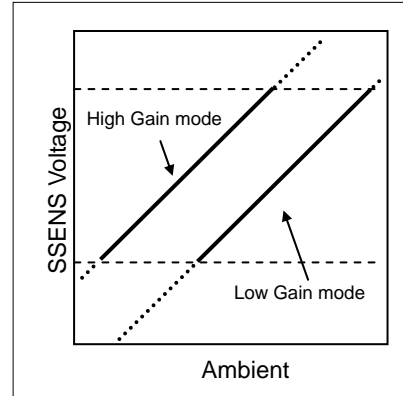

	Example 1 (Use BH1600FVC)				Example 2				Example 3	
Application example										
	Resister values are relative									
Operating mode	Auto	Manual		Auto	Manual		Fixed			
		High	Low		High	Low				
GAIN(1:0) setting	00	01	10	00	01	10	11			
Gain status	High   Low	High	Low	High   Low	High	Low	-			
GC1 output										
GC2 output										

: This means that it becomes High with A/D measurement cycle synchronously.  
 (\*1) : Set up the relative ratio of the resistance in the difference in the brightness change of the High Gain mode and the Low Gain mode carefully.

(4) A/D conversion

- The detection of ambient data is done periodically for the low power.
- SBIAS and ADC are turned off except for the ambient measurement.
- The sensor current may be shut in this function, it can possible to decrease the current consumption.
- SBIAS pin and SSENS pin are pull-down in internal when there are OFF.
- SBIAS circuit has the two modes. (Usually ON mode or intermittent mode)

Register : ADCYC(1:0)

Register : SBIASON

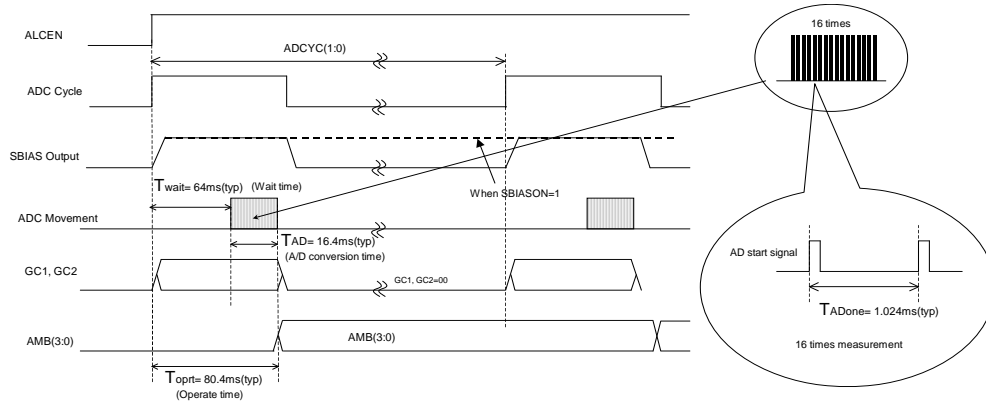

(5) ADC data Gain / offset adjustment

- To correct the characteristic dispersion of the sensor, Gain and offset adjustment to ADC output data is possible.
- They are controlled by register setup.

Register : SGAIN(3:0)

Register : SOFS(3:0)

< Gain Adjustment >

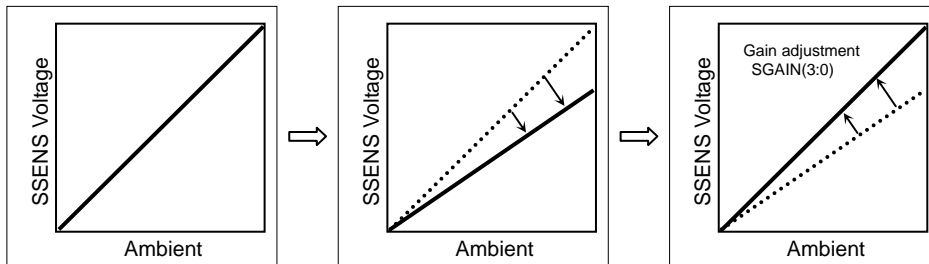

< Offset Adjustment >

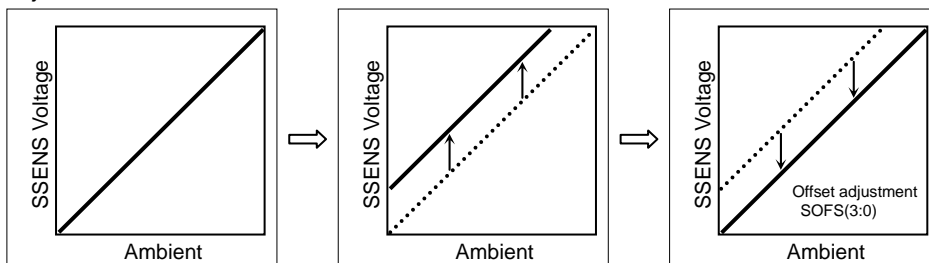

(6) Average filter

- Average filter is built in to rid noise or flicker.
- Average is 16 times

(7) Ambient level detection

- Averaged A/D value is converted to Ambient level corresponding to Gain control and sensor type.
- Ambient level is judged to rank of 16 steps by ambient data.
- The type of ambient light sensor can be chosen by register.

(Linear type sensor / Logarithm type sensor)

Register : STYPE

“0” : For Linear sensor

“1” : For Log sensor

- Ambient level is output through I<sup>2</sup>C.

Register : AMB(3:0)

STYPE	0				1	
GAIN(1:0)	00		10	01	11	xx
Gain Status	Low	High	Low	High	-	-
Ambient level	SSENS voltage					
0h	/	VoSx0 / 256	/	VoSx0 / 256	VoSx0 / 256	VoSx0 / 256 VoSx17 / 256
1h		VoSx1 / 256		VoSx1 / 256	VoSx1 / 256	VoSx18 / 256 VoSx26 / 256
2h		VoSx2 / 256		VoSx2 / 256	VoSx2 / 256	VoSx27 / 256 VoSx36 / 256
3h		VoSx3 / 256 VoSx4 / 256		VoSx3 / 256 VoSx4 / 256	VoSx3 / 256 VoSx4 / 256	VoSx37 / 256 VoSx47 / 256
4h		VoSx5 / 256 VoSx7 / 256		VoSx5 / 256 VoSx7 / 256	VoSx5 / 256 VoSx7 / 256	VoSx48 / 256 VoSx59 / 256
5h	VoSx0 / 256	VoSx8 / 256 VoSx12 / 256	VoSx0 / 256	VoSx8 / 256 VoSx12 / 256	VoSx7 / 256 VoSx9 / 256	VoSx60 / 256 VoSx71 / 256
6h	VoSx1 / 256	VoSx13 / 256 VoSx21 / 256	VoSx1 / 256	VoSx13 / 256 VoSx21 / 256	VoSx10 / 256 VoSx13 / 256	VoSx72 / 256 VoSx83 / 256
7h	VoSx2 / 256 VoSx3 / 256	VoSx22 / 256 VoSx37 / 256	VoSx2 / 256 VoSx3 / 256	VoSx22 / 256 VoSx37 / 256	VoSx14 / 256 VoSx19 / 256	VoSx84 / 256 VoSx95 / 256
8h	VoSx4 / 256 VoSx6 / 256	VoSx38 / 256 VoSx65 / 256	VoSx4 / 256 VoSx6 / 256	VoSx38 / 256 VoSx65 / 256	VoSx20 / 256 VoSx27 / 256	VoSx96 / 256 VoSx107 / 256
9h	VoSx7 / 256 VoSx11 / 256	VoSx66 / 256 VoSx113 / 256	VoSx7 / 256 VoSx11 / 256	VoSx66 / 256 VoSx113 / 256	VoSx28 / 256 VoSx38 / 256	VoSx108 / 256 VoSx119 / 256
Ah	VoSx12 / 256 VoSx20 / 256	VoSx114 / 256 VoSx199 / 256	VoSx12 / 256 VoSx20 / 256	VoSx114 / 256 VoSx199 / 256	VoSx39 / 256 VoSx53 / 256	VoSx120 / 256 VoSx131 / 256
Bh	VoSx21 / 256 VoSx36 / 256	VoSx200 / 256 VoSx255 / 256	VoSx21 / 256 VoSx36 / 256	VoSx200 / 256 VoSx255 / 256	VoSx54 / 256 VoSx74 / 256	VoSx132 / 256 VoSx143 / 256
Ch	VoSx37 / 256 VoSx64 / 256	/	VoSx37 / 256 VoSx64 / 256	/	VoSx75 / 256 VoSx104 / 256	VoSx144 / 256 VoSx155 / 256
Dh	VoSx65 / 256 VoSx114 / 256		VoSx65 / 256 VoSx114 / 256		VoSx105 / 256 VoSx144 / 256	VoSx156 / 256 VoSx168 / 256
Eh	VoSx115 / 256 VoSx199 / 256		VoSx115 / 256 VoSx199 / 256		VoSx145 / 256 VoSx199 / 256	VoSx169 / 256 VoSx181 / 256
Fh	VoSx200 / 256 VoSx255 / 256		VoSx200 / 256 VoSx255 / 256		VoSx200 / 256 VoSx255 / 256	VoSx182 / 256 VoSx255 / 256

- This is in case of not adjustments of the gain/offset control.
- In the Auto Gain control mode, sensor gain changes in gray-colored ambient level.
- “/” : This means that this zone is not outputted in this mode.

(8) LED current assignment

- LED current can be assigned as each of 16 steps of the ambient level.
- Setting of a user can do by overwriting, though it prepares for the table setup in advance.

Register : IU\*(6:0)

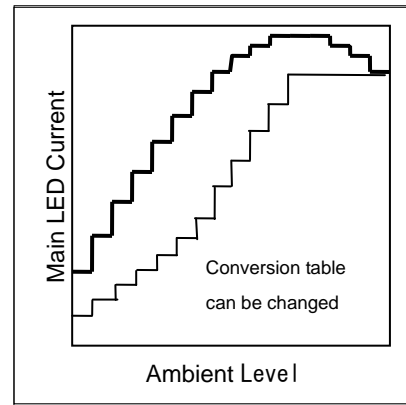

Conversion Table (initial value)

Ambient Level	Setting data	Current value	Ambient Level	Setting data	Current value
0h	11h	3.6mA	8h	48h	14.6mA
1h	13h	4.0mA	9h	56h	17.4mA
2h	15h	4.4mA	Ah	5Fh	19.2mA
3h	18h	5.0mA	Bh	63h	20.0mA
4h	1Eh	6.2mA	Ch	63h	20.0mA
5h	25h	7.6mA	Dh	63h	20.0mA
6h	2Fh	9.6mA	Eh	63h	20.0mA
7h	3Bh	12.0mA	Fh	63h	20.0mA

(9) Slope process

- Slope process is given to LED current to dim naturally.
- LED current changes in the 256Step gradation in sloping.
- Up(dark→bright), Down(bright→dark) LED current transition speed are set individually.

Register : THL(3:0)

Register : TLH(3:0)

- Main LED current changes as follows at the time as the slope. TLH (THL) is setup of time of the current step 2/256.

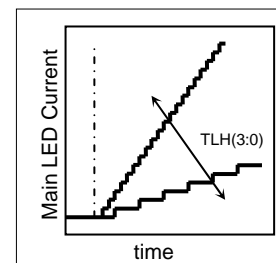
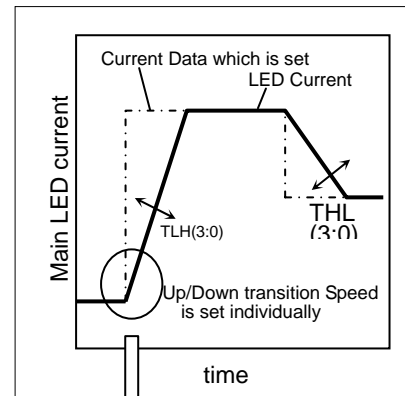
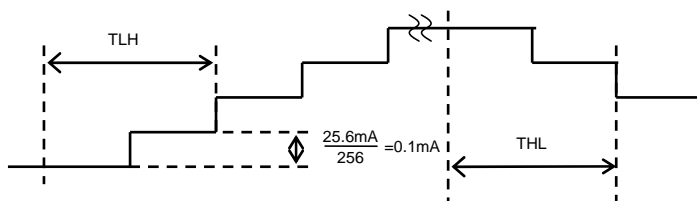

(10) LED current reset when mode change

- When mode is changed (ALC ↔ Non ALC), it can select the way to sloping.
- Register : MDCIR
- “0” : LED current non-reset when mode change
  - “1” : LED current reset when mode change

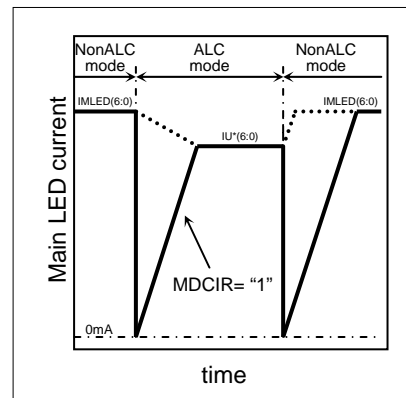
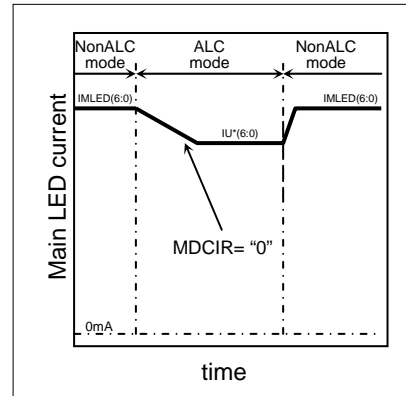

(11) Current adjustment

- When it is permitted by the register setting, PWM drive by the external terminal (WPWMIN) is possible.
- Register : WPWMEN
- It is suitable for the intensity correction by external control, because PWM based on Main LED current of register setup or ALC control.

WPWMEN	WPWMIN (External input)	Back light current	
0	L	ON	PWM input invalid
0	H	ON	
1	L	Forced OFF	PWM input valid
1	H	ON	

Current ON is depending on “MLEDEN”.

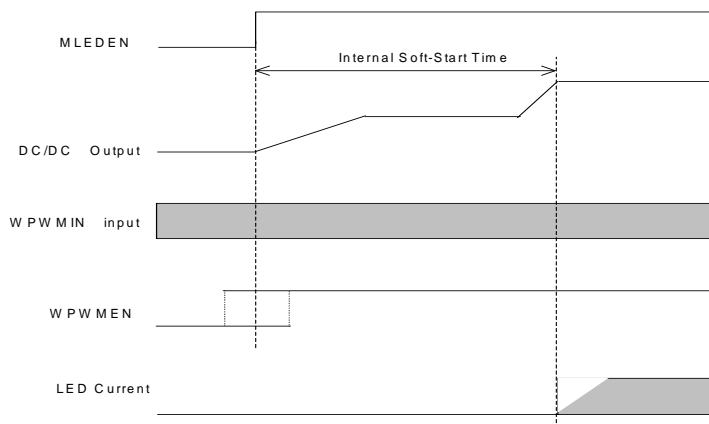

It can be inputted WPWMIN before MLEDEN=1.  
 It can be set WPWMEN=1 before MLEDEN=1.  
 PWM movement is effective at the time LED current rise up.  
 PWM High pulse width must be more than 80µs.

## 6. The explanation of I/O

When the RESETB pin is Low, the input buffers (SDA and SCL) are disabling for the Low consumption power.

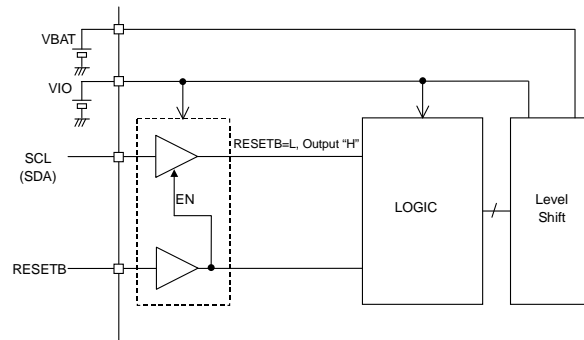

## 7. The explanation of the start of LDO1~LDO2

It must start as follows.

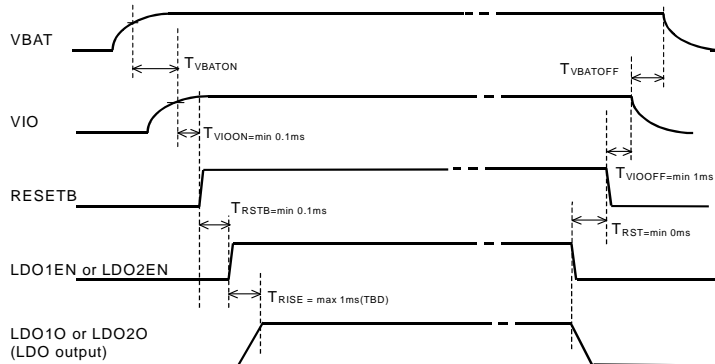

<Start Sequence>

VBAT ON (Enough rise up) → VIO ON (Enough rise up) → Reset release → LDO ON  
(Register access acceptable)

<End Sequence>

LDO OFF → Reset → VIO OFF (Enough fall down) → VBAT OFF

## 8. The explanation of the terminal management of the function that isn't used

Set up the terminal that isn't used as follows.

The LED terminal which isn't used : Short to ground

Don't do the control concerned with this terminal.

T1, T2 : Short to ground

T3, T4 : Open

● PCB pattern of the Power dissipation measuring board

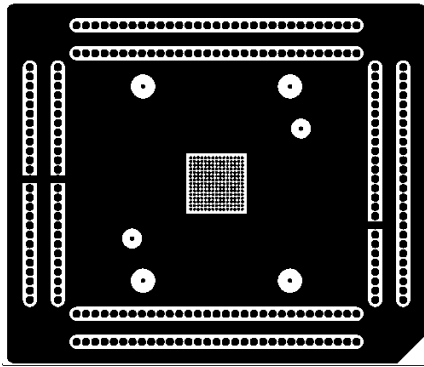

1<sup>st</sup> layer(component)

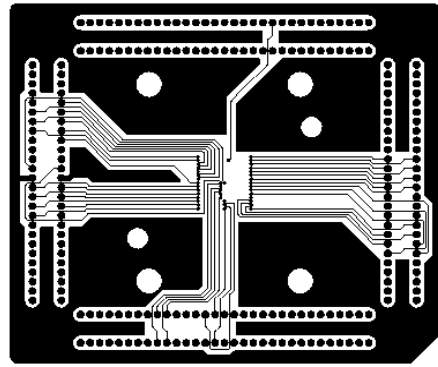

2<sup>nd</sup> layer

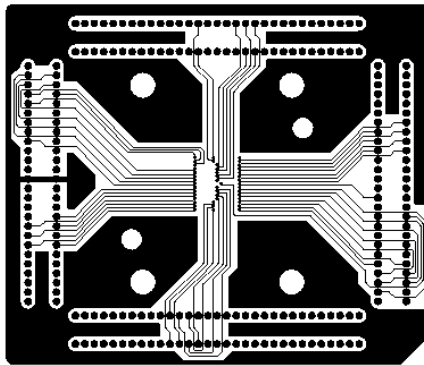

3<sup>rd</sup> layer

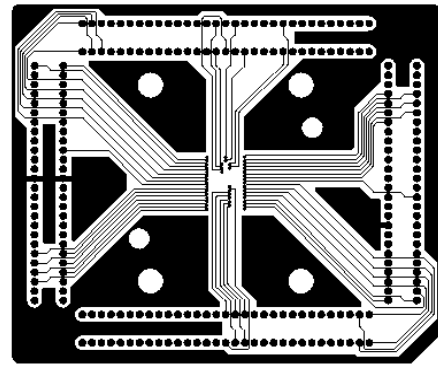

4<sup>th</sup> layer

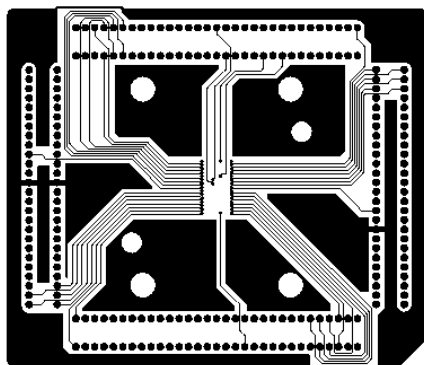

5<sup>th</sup> layer

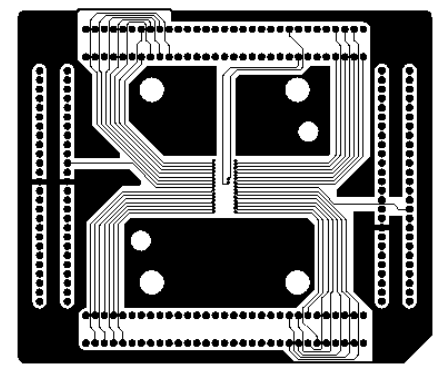

6<sup>th</sup> layer

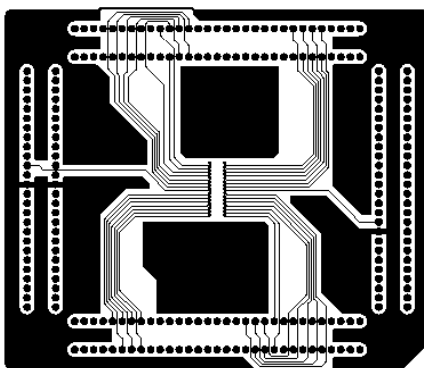

7<sup>th</sup> layer

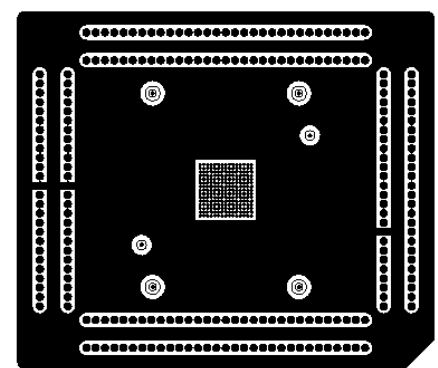

8<sup>th</sup> layer(solder)

**●Notes for use****(1) Absolute Maximum Ratings**

An excess in the absolute maximum ratings, such as supply voltage, temperature range of operating conditions, etc., can break down devices, thus making impossible to identify breaking mode such as a short circuit or an open circuit. If any special mode exceeding the absolute maximum ratings is assumed, consideration should be given to take physical safety measures including the use of fuses, etc.

**(2) Power supply and ground line**

Design PCB pattern to provide low impedance for the wiring between the power supply and the ground lines. Pay attention to the interference by common impedance of layout pattern when there are plural power supplies and ground lines. Especially, when there are ground pattern for small signal and ground pattern for large current included the external circuits, please separate each ground pattern. Furthermore, for all power supply pins to ICs, mount a capacitor between the power supply and the ground pin. At the same time, in order to use a capacitor, thoroughly check to be sure the characteristics of the capacitor to be used present no problem including the occurrence of capacity dropout at a low temperature, thus determining the constant.

**(3) Ground voltage**

Make setting of the potential of the ground pin so that it will be maintained at the minimum in any operating state. Furthermore, check to be sure no pins are at a potential lower than the ground voltage including an actual electric transient.

**(4) Short circuit between pins and erroneous mounting**

In order to mount ICs on a set PCB, pay thorough attention to the direction and offset of the ICs. Erroneous mounting can break down the ICs. Furthermore, if a short circuit occurs due to foreign matters entering between pins or between the pin and the power supply or the ground pin, the ICs can break down.

**(5) Operation in strong electromagnetic field**

Be noted that using ICs in the strong electromagnetic field can malfunction them.

**(6) Input pins**

In terms of the construction of IC, parasitic elements are inevitably formed in relation to potential. The operation of the parasitic element can cause interference with circuit operation, thus resulting in a malfunction and then breakdown of the input pin. Therefore, pay thorough attention not to handle the input pins, such as to apply to the input pins a voltage lower than the ground respectively, so that any parasitic element will operate. Furthermore, do not apply a voltage to the input pins when no power supply voltage is applied to the IC. In addition, even if the power supply voltage is applied, apply to the input pins a voltage lower than the power supply voltage or within the guaranteed value of electrical characteristics.

**(7) External capacitor**

In order to use a ceramic capacitor as the external capacitor, determine the constant with consideration given to a degradation in the nominal capacitance due to DC bias and changes in the capacitance due to temperature, etc.

**(8) Thermal shutdown circuit (TSD)**

This LSI builds in a thermal shutdown (TSD) circuit. When junction temperatures become detection temperature or higher, the thermal shutdown circuit operates and turns a switch OFF. The thermal shutdown circuit, which is aimed at isolating the LSI from thermal runaway as much as possible, is not aimed at the protection or guarantee of the LSI. Therefore, do not continuously use the LSI with this circuit operating or use the LSI assuming its operation.

**(9) Thermal design**

Perform thermal design in which there are adequate margins by taking into account the permissible dissipation (Pd) in actual states of use.

**(10) LDO**

Use each output of LDO by the independence. Don't use under the condition that each output is short-circuited because it has the possibility that an operation becomes unstable.

**(11) About the pin for the test, the un-use pin**

Prevent a problem from being in the pin for the test and the un-use pin under the state of actual use. Please refer to a function manual and an application notebook. And, as for the pin that doesn't specially have an explanation, ask our company person in charge.

**(12) About the rush current**

For ICs with more than one power supply, it is possible that rush current may flow instantaneously due to the internal powering sequence and delays. Therefore, give special consideration to power coupling capacitance, power wiring, width of ground wiring, and routing of wiring.

**(13) About the function description or application note or more.**

The function description and the application notebook are the design materials to design a set. So, the contents of the materials aren't always guaranteed. Please design application by having fully examination and evaluation include the external elements.

● Power dissipation (On the ROHM's standard board)

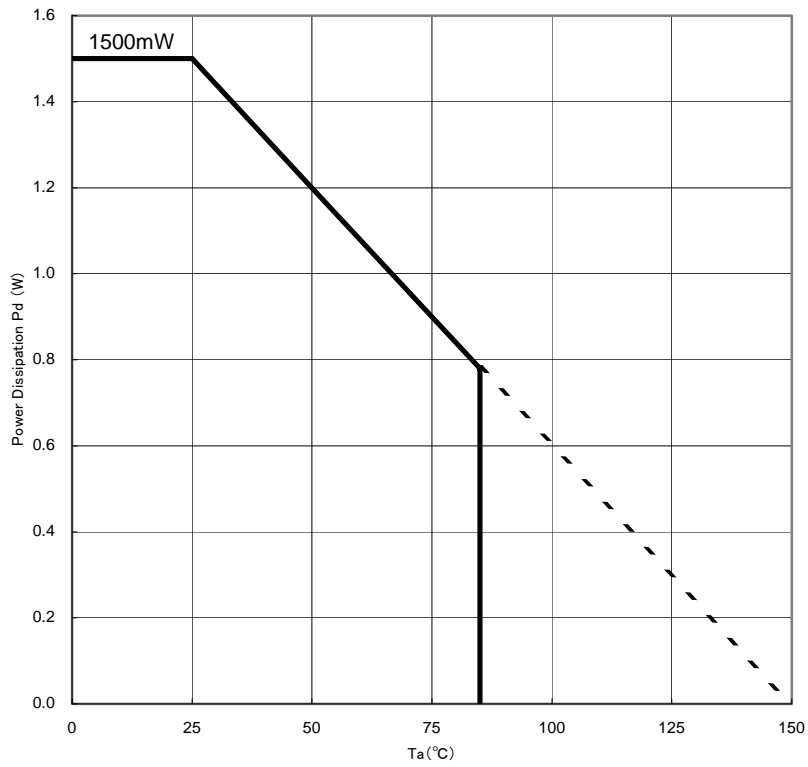

Information of the ROHM's standard board

Material : glass-epoxy

Size : Refer to after page.

● Ordering part number

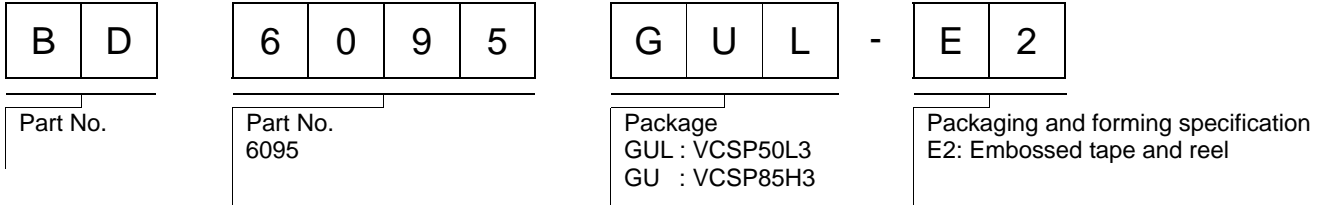

**VCSP50L3(BD6095GUL)**

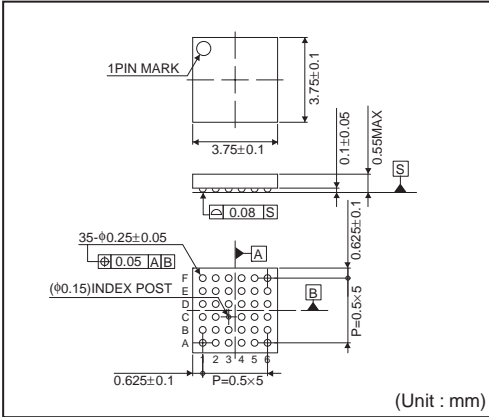

<Tape and Reel information>

Tape	Embossed carrier tape
Quantity	2500pcs
Direction of feed	E2 ( The direction is the 1pin of product is at the upper left when you hold reel on the left hand and you pull out the tape on the right hand )

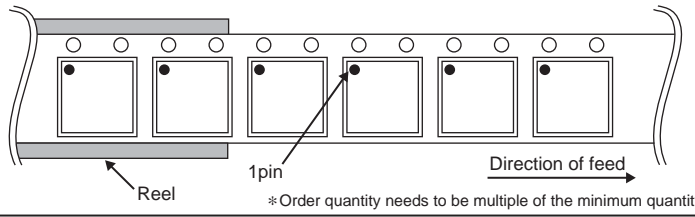

**VCSP85H3 (BD6095GU)**

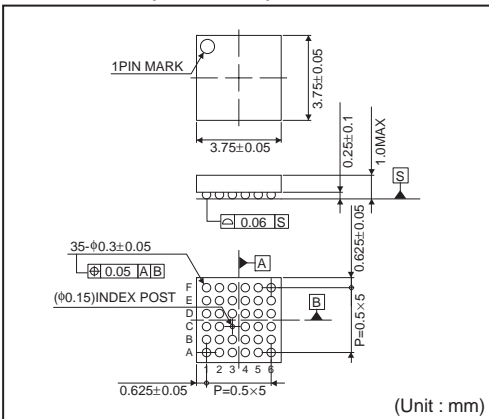

<Tape and Reel information>

Tape	Embossed carrier tape
Quantity	2500pcs
Direction of feed	E2 ( The direction is the 1pin of product is at the upper left when you hold reel on the left hand and you pull out the tape on the right hand )

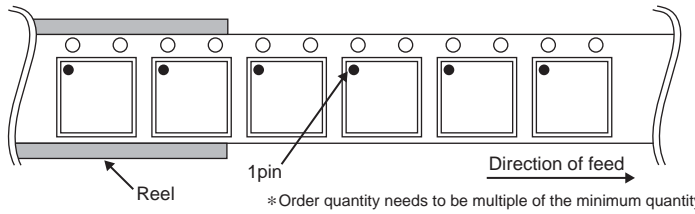

# Notice

## Precaution on using ROHM Products

- Our Products are designed and manufactured for application in ordinary electronic equipments (such as AV equipment, OA equipment, telecommunication equipment, home electronic appliances, amusement equipment, etc.). If you intend to use our Products in devices requiring extremely high reliability (such as medical equipment <sup>(Note 1)</sup>, transport equipment, traffic equipment, aircraft/spacecraft, nuclear power controllers, fuel controllers, car equipment including car accessories, safety devices, etc.) and whose malfunction or failure may cause loss of human life, bodily injury or serious damage to property ("Specific Applications"), please consult with the ROHM sales representative in advance. Unless otherwise agreed in writing by ROHM in advance, ROHM shall not be in any way responsible or liable for any damages, expenses or losses incurred by you or third parties arising from the use of any ROHM's Products for Specific Applications.

(Note1) Medical Equipment Classification of the Specific Applications

JAPAN	USA	EU	CHINA
CLASS III	CLASS III	CLASS II b	CLASS III
CLASS IV		CLASS III	

- ROHM designs and manufactures its Products subject to strict quality control system. However, semiconductor products can fail or malfunction at a certain rate. Please be sure to implement, at your own responsibilities, adequate safety measures including but not limited to fail-safe design against the physical injury, damage to any property, which a failure or malfunction of our Products may cause. The following are examples of safety measures:
  - Installation of protection circuits or other protective devices to improve system safety
  - Installation of redundant circuits to reduce the impact of single or multiple circuit failure
- Our Products are designed and manufactured for use under standard conditions and not under any special or extraordinary environments or conditions, as exemplified below. Accordingly, ROHM shall not be in any way responsible or liable for any damages, expenses or losses arising from the use of any ROHM's Products under any special or extraordinary environments or conditions. If you intend to use our Products under any special or extraordinary environments or conditions (as exemplified below), your independent verification and confirmation of product performance, reliability, etc. prior to use, must be necessary:
  - Use of our Products in any types of liquid, including water, oils, chemicals, and organic solvents
  - Use of our Products outdoors or in places where the Products are exposed to direct sunlight or dust
  - Use of our Products in places where the Products are exposed to sea wind or corrosive gases, including Cl<sub>2</sub>, H<sub>2</sub>S, NH<sub>3</sub>, SO<sub>2</sub>, and NO<sub>2</sub>
  - Use of our Products in places where the Products are exposed to static electricity or electromagnetic waves
  - Use of our Products in proximity to heat-producing components, plastic cords, or other flammable items
  - Sealing or coating our Products with resin or other coating materials
  - Use of our Products without cleaning residue of flux (even if you use no-clean type fluxes, cleaning residue of flux is recommended); or Washing our Products by using water or water-soluble cleaning agents for cleaning residue after soldering
  - Use of the Products in places subject to dew condensation
- The Products are not subject to radiation-proof design.
- Please verify and confirm characteristics of the final or mounted products in using the Products.
- In particular, if a transient load (a large amount of load applied in a short period of time, such as pulse. is applied, confirmation of performance characteristics after on-board mounting is strongly recommended. Avoid applying power exceeding normal rated power; exceeding the power rating under steady-state loading condition may negatively affect product performance and reliability.
- De-rate Power Dissipation (Pd) depending on Ambient temperature (Ta). When used in sealed area, confirm the actual ambient temperature.
- Confirm that operation temperature is within the specified range described in the product specification.
- ROHM shall not be in any way responsible or liable for failure induced under deviant condition from what is defined in this document.

## Precaution for Mounting / Circuit board design

- When a highly active halogenous (chlorine, bromine, etc.) flux is used, the residue of flux may negatively affect product performance and reliability.
- In principle, the reflow soldering method must be used; if flow soldering method is preferred, please consult with the ROHM representative in advance.

For details, please refer to ROHM Mounting specification

### Precautions Regarding Application Examples and External Circuits

1. If change is made to the constant of an external circuit, please allow a sufficient margin considering variations of the characteristics of the Products and external components, including transient characteristics, as well as static characteristics.
2. You agree that application notes, reference designs, and associated data and information contained in this document are presented only as guidance for Products use. Therefore, in case you use such information, you are solely responsible for it and you must exercise your own independent verification and judgment in the use of such information contained in this document. ROHM shall not be in any way responsible or liable for any damages, expenses or losses incurred by you or third parties arising from the use of such information.

### Precaution for Electrostatic

This Product is electrostatic sensitive product, which may be damaged due to electrostatic discharge. Please take proper caution in your manufacturing process and storage so that voltage exceeding the Products maximum rating will not be applied to Products. Please take special care under dry condition (e.g. Grounding of human body / equipment / solder iron, isolation from charged objects, setting of ionizer, friction prevention and temperature / humidity control).

### Precaution for Storage / Transportation

1. Product performance and soldered connections may deteriorate if the Products are stored in the places where:
  - [a] the Products are exposed to sea winds or corrosive gases, including Cl<sub>2</sub>, H<sub>2</sub>S, NH<sub>3</sub>, SO<sub>2</sub>, and NO<sub>2</sub>
  - [b] the temperature or humidity exceeds those recommended by ROHM
  - [c] the Products are exposed to direct sunshine or condensation
  - [d] the Products are exposed to high Electrostatic
2. Even under ROHM recommended storage condition, solderability of products out of recommended storage time period may be degraded. It is strongly recommended to confirm solderability before using Products of which storage time is exceeding the recommended storage time period.
3. Store / transport cartons in the correct direction, which is indicated on a carton with a symbol. Otherwise bent leads may occur due to excessive stress applied when dropping of a carton.
4. Use Products within the specified time after opening a humidity barrier bag. Baking is required before using Products of which storage time is exceeding the recommended storage time period.

### Precaution for Product Label

QR code printed on ROHM Products label is for ROHM's internal use only.

### Precaution for Disposition

When disposing Products please dispose them properly using an authorized industry waste company.

### Precaution for Foreign Exchange and Foreign Trade act

Since our Products might fall under controlled goods prescribed by the applicable foreign exchange and foreign trade act, please consult with ROHM representative in case of export.

### Precaution Regarding Intellectual Property Rights

1. All information and data including but not limited to application example contained in this document is for reference only. ROHM does not warrant that foregoing information or data will not infringe any intellectual property rights or any other rights of any third party regarding such information or data. ROHM shall not be in any way responsible or liable for infringement of any intellectual property rights or other damages arising from use of such information or data.:
2. No license, expressly or implied, is granted hereby under any intellectual property rights or other rights of ROHM or any third parties with respect to the information contained in this document.

### Other Precaution

1. This document may not be reprinted or reproduced, in whole or in part, without prior written consent of ROHM.
2. The Products may not be disassembled, converted, modified, reproduced or otherwise changed without prior written consent of ROHM.
3. In no event shall you use in any way whatsoever the Products and the related technical information contained in the Products or this document for any military purposes, including but not limited to, the development of mass-destruction weapons.
4. The proper names of companies or products described in this document are trademarks or registered trademarks of ROHM, its affiliated companies or third parties.

**General Precaution**

1. Before you use our Products, you are requested to carefully read this document and fully understand its contents. ROHM shall not be in any way responsible or liable for failure, malfunction or accident arising from the use of any ROHM's Products against warning, caution or note contained in this document.
2. All information contained in this document is current as of the issuing date and subject to change without any prior notice. Before purchasing or using ROHM's Products, please confirm the latest information with a ROHM sales representative.
3. The information contained in this document is provided on an "as is" basis and ROHM does not warrant that all information contained in this document is accurate and/or error-free. ROHM shall not be in any way responsible or liable for any damages, expenses or losses incurred by you or third parties resulting from inaccuracy or errors of or concerning such information.

# Mouser Electronics

Authorized Distributor

Click to View Pricing, Inventory, Delivery & Lifecycle Information:

[ROHM Semiconductor:](#)

[BD6095GUL-E2](#)