

# 40×40×20 mm

San Ace 40 9P type   



## General Specifications

- Material ..... Frame: Plastic (Flammability: UL 94V-0), Impeller: Plastic (Flammability: UL 94V-1)
- Expected life ..... See the table below. (L10 life: 90% survival rate for continuous operation in free air at 60°C, rated voltage)
- Motor protection function ..... Locked rotor burnout protection, Reverse polarity protection  
For details, please refer to p. 547.
- Dielectric strength ..... 50/60 Hz, 500 VAC, for 1 minute (between lead wire conductors and frame)
- Insulation resistance ..... 10 MΩ or more with a 500 VDC megger (between lead wire conductors and frame)
- Sound pressure level (SPL) ..... At 1 m away from the air inlet
- Storage temperature ..... -30 to +70°C (Non-condensing)
- Lead wire ..... ⊕Red ⊖Black or Blue (Sensor) Yellow
- Mass ..... 45 g

## Specifications

The models listed below **have ribs and pulse sensors.**

| Model no.           | Rated voltage [V] | Operating voltage range [V] | Rated current [A] | Rated input [W] | Rated speed [min <sup>-1</sup> ] | Max. airflow [m <sup>3</sup> /min] [CFM] | Max. static pressure [Pa] [inchH <sub>2</sub> O] | SPL [dB (A)] | Operating temperature [°C] | Expected life [h] |
|---------------------|-------------------|-----------------------------|-------------------|-----------------|----------------------------------|--|--|--------------|----------------------------|-------------------|
| <b>109P0405J601</b> | 5                 | 4.5 to 5.5                  | 0.46              | 2.3             | 9800                             | 0.28 9.9                                 | 98.5 0.396                                       | 39           | -20 to +70                 | 40000/60°C        |
| <b>109P0405H601</b> |                   |                             | 0.32              | 1.6             | 8000                             | 0.225 8.0                                | 65.7 0.264                                       | 33           |                            |                   |
| <b>109P0405F601</b> |                   |                             | 0.25              | 1.25            | 6500                             | 0.183 6.5                                | 45.1 0.181                                       | 28           |                            |                   |
| <b>109P0405M601</b> |                   |                             | 0.12              | 0.6             | 5000                             | 0.136 4.8                                | 26.5 0.106                                       | 24           |                            |                   |
| <b>109P0412G601</b> | 12                | 7 to 13.8                   | 0.28              | 3.36            | 12500                            | 0.35 12.4                                | 153.8 0.618                                      | 44           | -20 to +60                 | 40000/60°C        |
| <b>109P0412D601</b> |                   |                             | 0.18              | 2.16            | 11000                            | 0.31 10.9                                | 124 0.498  | 42           |                            |                   |
| <b>109P0412E601</b> |                   |                             | 0.13              | 1.56            | 9200                             | 0.26 9.2                                 | 87.3 0.351                                       | 37           |                            |                   |
| <b>109P0412H601</b> |                   |                             | 0.11              | 1.32            | 8000                             | 0.225 8.0                                | 65.7 0.264                                       | 33           |                            |                   |
| <b>109P0412F601</b> |                   |                             | 0.09              | 1.08            | 6500                             | 0.183 6.5                                | 45.1 0.181                                       | 28           |                            |                   |
| <b>109P0412M601</b> | 8 to 13.8         | 0.06                        | 0.72              | 5000            | 0.136 4.8                        | 26.5 0.106                               | 24   |              |                            |                   |
| <b>109P0424G601</b> | 24                | 12 to 27.6                  | 0.15              | 3.6             | 12500                            | 0.35 12.4                                | 153.8 0.618                                      | 44           | -20 to +60                 | 40000/60°C        |
| <b>109P0424D601</b> |                   | 12 to 27.6                  | 0.13              | 3.12            | 11000                            | 0.31 10.9                                | 124 0.498  | 42           |                            |                   |
| <b>109P0424H601</b> |                   | 12 to 27.6                  | 0.07              | 1.68            | 8300                             | 0.233 8.2                                | 69.6 0.28  | 35           |                            |                   |
| <b>109P0424F601</b> |                   | 14 to 27.6                  | 0.06              | 1.44            | 6500                             | 0.183 6.5                                | 45.1 0.181                                       | 28           |                            |                   |
| <b>109P0424B601</b> |                   | 20.4 to 27.6                | 0.06              | 1.44            | 5200                             | 0.14 4.9                                 | 28.3 0.114                                       | 25           |                            |                   |

The following sensor and control options are available for selection.

Available for all models. **Without sensor**

Differs according to the model. Refer to the table on pp. 562 to 563. **Lock sensor**

## Airflow - Static Pressure Characteristics

**109P0405J601** With pulse sensor

Operating voltage range

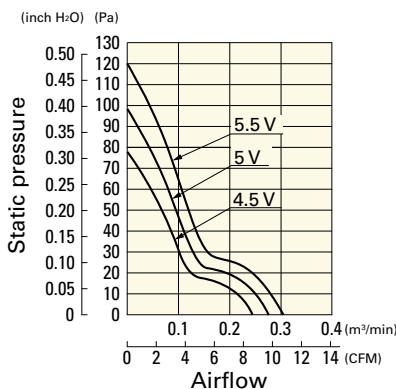

**109P0405H601** With pulse sensor

Operating voltage range

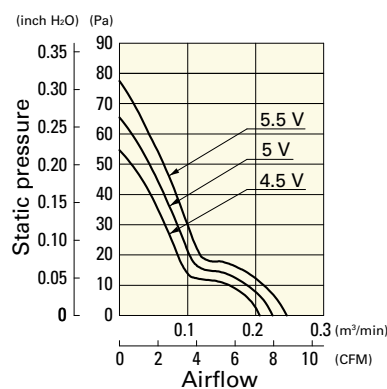

**109P0405F601** With pulse sensor

Operating voltage range

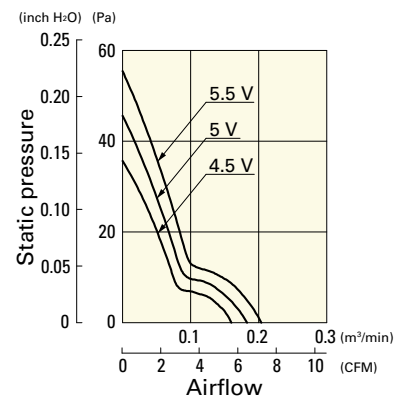

# Airflow - Static Pressure Characteristics

**109P0405M601** With pulse sensor

Operating voltage range

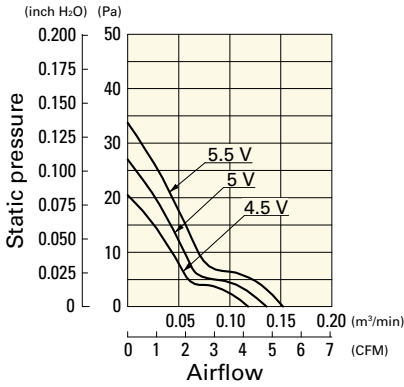

**109P0412G601** With pulse sensor

Operating voltage range

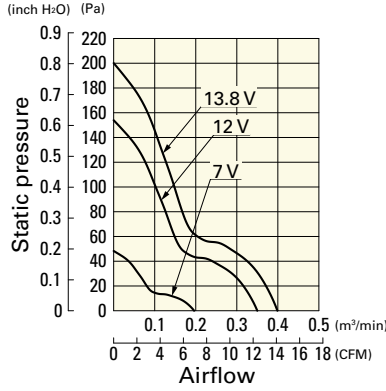

**109P0412D601** With pulse sensor

Operating voltage range

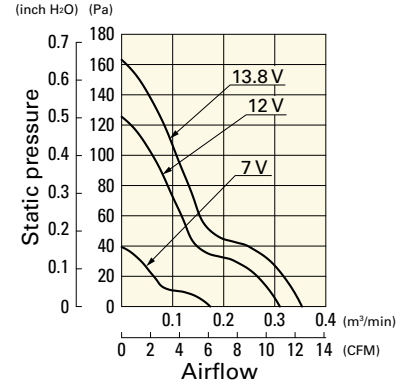

**109P0412E601** With pulse sensor

Operating voltage range

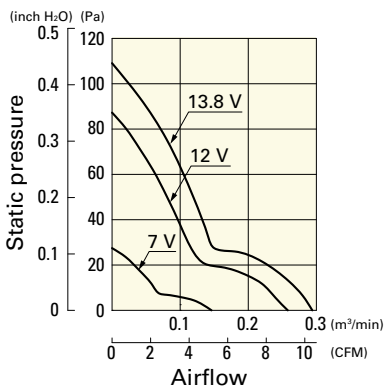

**109P0412H601** With pulse sensor

Operating voltage range

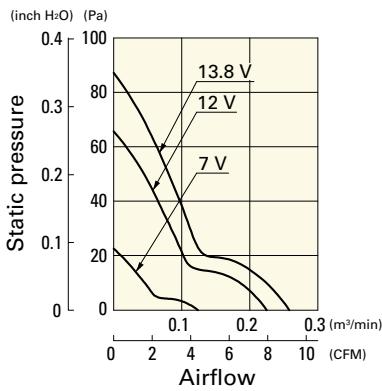

**109P0412F601** With pulse sensor

Operating voltage range

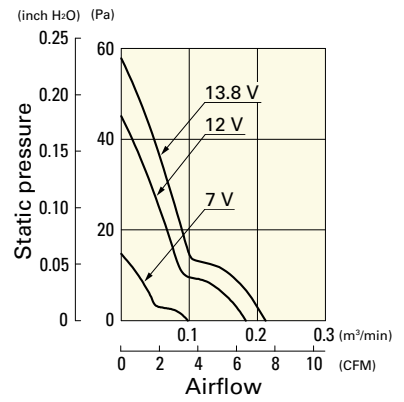

**109P0412M601** With pulse sensor

Operating voltage range

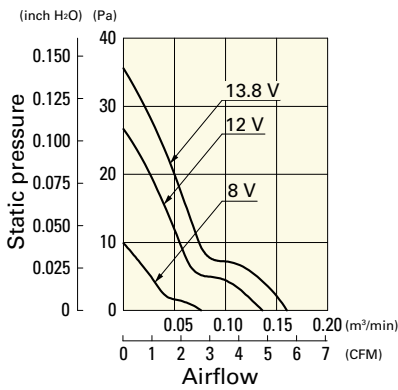

**109P0424G601** With pulse sensor

Operating voltage range

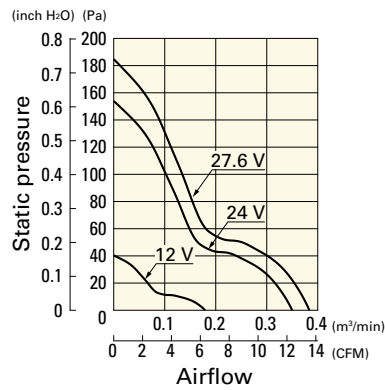

**109P0424D601** With pulse sensor

Operating voltage range

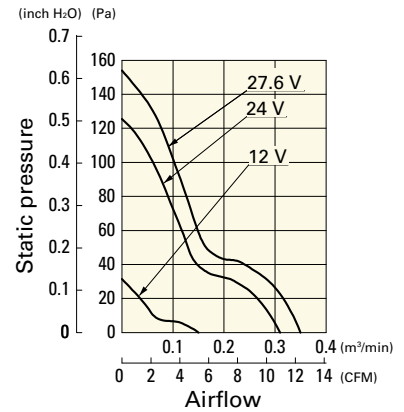

**109P0424H601** With pulse sensor

Operating voltage range

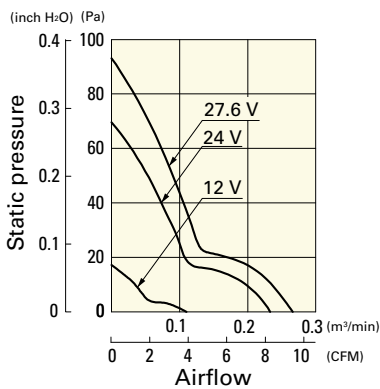

**109P0424F601** With pulse sensor

Operating voltage range

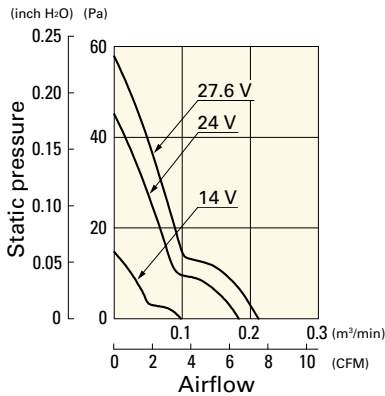

**109P0424B601** With pulse sensor

Operating voltage range

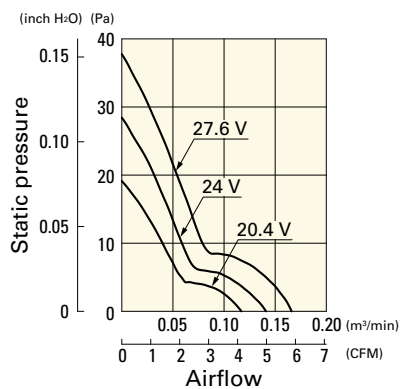

## ■ Dimensions (unit: mm)

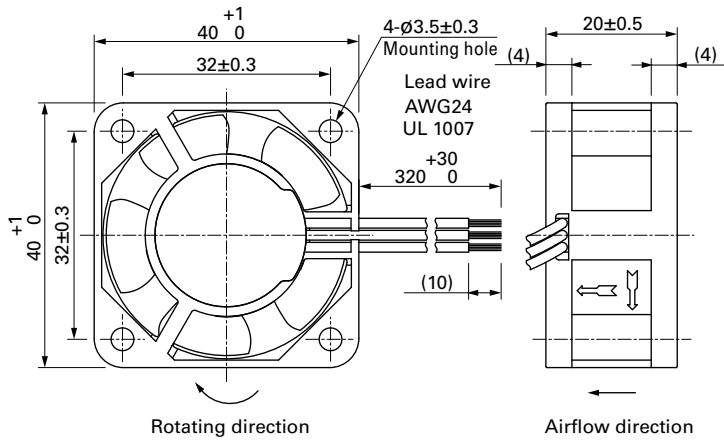

## ■ Reference Dimensions of Mounting Holes and Vent Opening (unit: mm)

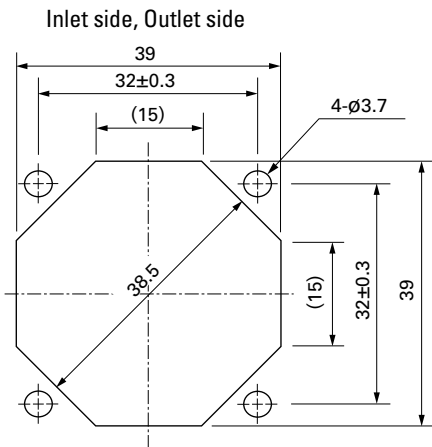

## ■ Options

Finger guards

page: p. 532

Model no.: 109-059, 109-059H

# Mouser Electronics

Authorized Distributor

Click to View Pricing, Inventory, Delivery & Lifecycle Information:

## Sanyo Denki:

[109P0405F601](#) [109P0405H601](#) [109P0405J601](#) [109P0405M601](#) [109P0412D601](#) [109P0412E601](#) [109P0412F601](#)  
[109P0412G601](#) [109P0412H601](#) [109P0412M601](#) [109P0424B601](#) [109P0424D601](#) [109P0424F601](#) [109P0424G601](#)  
[109P0424H601](#) [109P0412H602](#) [109P0405H602](#) [109P0412M602](#) [109P0405H6D01](#) [109P0424H602](#) [109P0412D602](#)  
[109P0424D6D01](#) [109P0412E6D01](#) [109P0412D6D01](#) [109P0424H6D01](#) [109P0412F602](#) [109P0424B6D01](#)  
[109P0412G6D01](#) [109P0412G602](#) [109P0424D602](#) [109P0424G602](#) [109P0412E602](#) [109P0412M6D01](#)  
[109P0424F6D01](#) [109P0424F602](#) [109P0424B602](#) [109P0412F6D01](#) [109P0412H6D01](#) [109P0405F602](#)  
[109P0405M6D01](#) [109P0405F6D01](#) [109P0405J602](#) [109P0405M602](#) [109P0405J6D01](#) [109P0424G6D01](#)