

Miniature Relay PT

- 2 pole 12A, 3 pole 10A or 4 pole 6A, 2, 3 or 4 form C (CO) contacts
- DC or AC coil
- Switching performance up to 3000VA
- Relay height 29mm
- Mechanical indicator, optional LED and protection diode
- Manual test tab, optionally lockable
- White marking tabs



F0191-B



Typical applications
Universal use in control and automation

Approvals

VDE Cert. No. 40009108, UL E214025, Lloyds 00/20059
Technical data of approved types on request

Contact Data	PT2	PT3	PT5
Contact arrangement	2 form C 2 CO	3 form C 3 CO	4 form C 4 CO
Rated voltage	240VAC		
Max. switching voltage	400VAC	400VAC	240VAC
Rated current	12A	10A	6A
Limiting making current, max. 20ms	24A	20A	12A
Limiting breaking current	12A	10A	6A
Limiting short-time current	300A/30ms		
Switching power	3000VA	2500VA	1500VA
Contact material	AgNi90/10, AgNi90/10 gold plated		
Min. recommended contact load	12V at 10mA gold plated: 20mV at 1mA 30mV at 100mA/6VDC		
Initial voltage drop			
Frequency of operation with/without load	360/36000h ⁻¹		
Operate time typ., DC coil	15ms		
Release time typ., DC coil, without/with PD	10/18ms		
Bounce time typ., DC coil, form A/form B	6/8ms		

Contact ratings

Type	Contact	Load	Cycles
IEC 61810			
PT 2 DC/AC coil	C (CO)	12A, 250VAC, cosφ=1, 70°C	70x10 ³
PT 2 DC/AC coil	A (NO) of C (CO)	9A, 250VAC, cosφ=1, 80°C	150x10 ³
PT 2 DC/AC coil	A (NO) of C (CO)	4A, 250VAC, cosφ=1, 80°C	300x10 ³
PT 3 DC/AC coil	C (CO)	10A, 250VAC, cosφ=1, 70°C	100x10 ³
PT 5 DC/AC coil	C (CO)	6A, 250VAC, cosφ=1, 70°C	100x10 ³

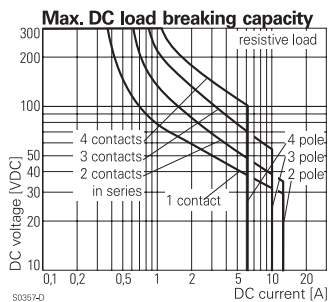

Contact Data (continued)

Type	Contact	Load	Cycles
UL 508			
PT 2	C (CO)	12A, 250VAC, general purpose, 70°C	6.000
PT 2	C (CO)	12A, 250VAC, resistive, 70°C	100x10 ³
PT 2	A (NO) of C (CO)	12A, 250VAC, resistive, 70°C	100x10 ³
PT 2	A (NO) of C (CO)	12A, 250VAC, resistive, 70°C	100x10 ³
PT 3	C (CO)	10A, 250VAC, general purpose, 70°C	6.000
PT 3	C (CO)	10A, 250VAC, resistive, 70°C	100x10 ³
PT 3	A (NO) of C (CO)	10A, 250VAC, resistive, 70°C	100x10 ³
PT 3	B (NC) of C (CO)	10A, 250VAC, resistive, 70°C	100x10 ³
PT 5	C (CO)	6A, 250VAC, general purpose, 70°C	6.000
PT 5	C (CO)	6A, 250VAC, resistive, 70°C	100x10 ³
PT 5	A (NO) of C (CO)	6A, 250VAC, resistive, 70°C	100x10 ³
PT 5	B (NC) of C (CO)	6A, 250VAC, resistive, 70°C	100x10 ³
EN60947-4-1			
PT 2	A (NO) of C (CO)	400VAC, 3.75A, AC3, opposite polarity, 70°C	
PT 2	A (NO) of C (CO)	230VAC, 1.7A, AC5b (400W lamp load), opposite polarity, 70°C	
PT 3	A (NO) of C (CO)	250VAC, 2A, AC3, opposite polarity 70°C	
PT 3	A (NO) of C (CO)	230VAC, 1.7A, AC5b (400W lamp load), opposite polarity, 70°C	
PT 5	A (NO) of C (CO)	250VAC, 3A, AC3, same polarity 70°C	
PT 5	A (NO) of C (CO)	230VAC, 1.7A, AC5b (400W lamp load), same polarity, 70°C	
PT 2	A (NO) of C (CO)	DC coil, AC-15, 250VAC/4A, opposite polarity 6.050	
PT 3	A (NO) of C (CO)	DC coil, AC-15, 250VAC/4A, same polarity 6.050	
PT 5	A (NO) of C (CO)	DC coil, AC-15, 250VAC/4A, same polarity 6.050	
PT 2	A (NO) of C (CO)	AC coil, AC-15, 250VAC/2A, opposite polarity 6.050	
PT 3	A (NO) of C (CO)	AC coil, AC-15, 250VAC/2A, same polarity 6.050	
PT 5	A (NO) of C (CO)	AC coil, AC-15, 250VAC/2A, same polarity 6.050	
PT2/3/5	A (NO) of C (CO)	DC-13, 24VDC/4A 6.050	

Mechanical endurance	
DC coil	30x10 ⁶ operations
AC coil	20x10 ⁶ operations

Coil Data

Coil voltage range	6 to 220VDC 6 to 230VAC
Operative range, IEC 61810	
DC coil, AC-coil 50Hz	2
AC coil 60 Hz at 70°C	90..110% of rated voltage
Coil insulation system according UL	class 155 (F)

Miniature Relay PT (Continued)

Coil Data (continued)

Coil versions, DC coil, standard

Coil code	Rated voltage VDC	Operate voltage VDC	Release voltage VDC	Coil resistance $\Omega \pm 10\%^{1)2)}$	Rated coil power mW
006	6	4.5	0.6	48	750
012	12	9.0	1.2	192	750
024	24	18.0	2.4	777	741
048	48	36.0	4.8	3072	750
060	60	45.0	6	4845 ¹⁾	743
110	110	82.5	11	16133 ²⁾	750
220	220	165.0	22	64533 ²⁾	750

Coil versions, DC coil with bipolar LED or LED and protection diode

Coil code	Rated voltage VDC	Operate voltage VDC	Release voltage VDC	Coil resistance $\Omega \pm 10\%^{1)2)}$	Rated coil +LED pwr. mW
L06 LA6	6	4.5	0.6	48	750+3.5
L12 LB2	12	9.0	1.2	192	750+10
L24 LC4	24	18.0	2.4	777	741+18
L48 LE8	48	36.0	4.8	3072	750+38
L60 LG0	60	45.0	6.0	4845 ¹⁾	743+56
M10 MB0	110	82.5	11.0	16133 ²⁾	750+96.5
N20 NC0	220	165.0	22.0	64533 ²⁾	750+202.5

1) Coil resistance $\pm 12\%$, 2) Coil resistance $\pm 15\%$,

3) Protection diode PD; standard polarity: +A1/-A2

All figures are given for coil without pre-energization, at ambient temperature +23°C

Coil versions, AC coil, 50/60Hz

Coil code	Rated voltage VAC	Operate voltage 50/60Hz VAC	Release voltage 50/60Hz VAC	Coil resistance $\Omega \pm 10\%^{1)2)}$	Rated coil power 50/60Hz VA
506 R06	6	4.8/5.4	1.8	11	1.0/0.85
512 R12	12	9.6/10.8	3.6	48	1.0/0.85
524 R24	24	19.2/21.6	7.2	192	1.0/0.79
548 R48	48	38.4/43.2	14.4	777	1.0/0.87
560 R60	60	48.0/54.0	18.0	1306	1.0/0.87
615 S15	115	92.0/103.5	34.5	4845 ¹⁾	1.0/0.86
730 T30	230	184/207	69.0	19465 ²⁾	1.0/0.90

1) Coil resistance $\pm 12\%$, 2) Coil resistance $\pm 15\%$

All figures are given for coil without pre-energization, at ambient temperature +23°C



Insulation Data

	PT2	PT3	PT5
Initial dielectric strength			
between open contacts	1200V _{rms}	1200V _{rms}	1200V _{rms}
between contact and coil	2500V _{rms}	2500V _{rms}	2500V _{rms}
between adjacent contacts	2500V _{rms}	2500V _{rms}	2000V _{rms}
Initial surge withstand voltage			
between contact and coil	5000V (1.2/50µs)		
Clearance/creepage			
between contact and coil	≥3/4mm		
Material group of insulation parts	IIIa		
Pollution degree	2		

Other Data

Material compliance: EU RoHS/ELV, China RoHS, REACH, Halogen content refer to the Product Compliance Support Center at www.te.com/customer-support/rohssupportcenter

Ambient temperature	-40 to +70°C
Cold storage, IEC 60068-2-1	-40°C/16h
Dry heat, IEC 60068-2-2	70°C/16h
Category of environmental protection	
IEC 61810	RTII - flux proof
Vibration resistance (functional), form A (NO)/form B (NC)	7/4g
Shock resistance (functional), form A (NO)/form B (NC)	20/5g
Terminal type	PCB-THT, plug-in quick-connect
Cover retention, pull/push force	100/100N
Weight	30g
Mounting distance, for mounting on PCB	5mm
Resistance to soldering heat THT	
IEC 60068-2-20	270°C/10s
Packaging unit	10/250pcs.

Accessories

For details see datasheet [Accessories Miniature Relay PT](#)

Note: indicated contact ratings and electrical endurance data for direct wiring of relays (according IEC 61810-1); for relays mounted on sockets deratings may apply.

Product Sets

Complete sets consisting of a relay mounted on a socket see

[Package PT](#)

Miniature Relay PT (Continued)

PCB layout / terminal assignment

Bottom view on pins

4 pole

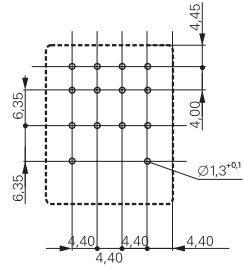

S0354-AA

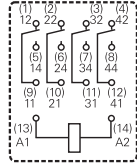

S0354-AD

3 pole

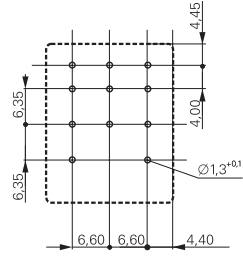

S0354-AB

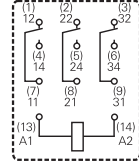

S0354-AE

2 pole

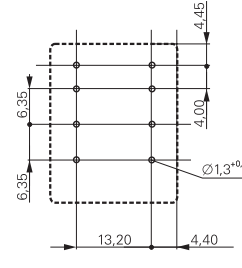

S0354-AC

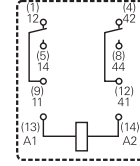

S0354-AF

Circuit

LED

protection diode+LED

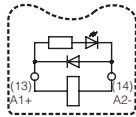
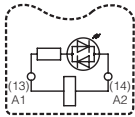

Dimensions

Solder- and plug-in terminals (standard version)

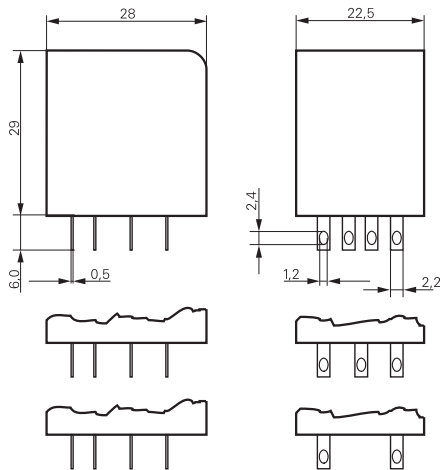

PCB version

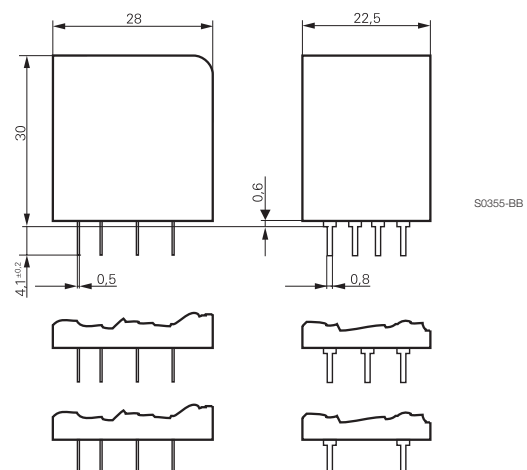

Miniature Relay PT (Continued)

Product code structure

Typical product code **PT 5 7 0 730**

Type	PT Miniature Relay PT				
Contact arrangement	2 2 form C contacts (2 CO contacts) 3 3 form C contacts (3 CO contacts) 5 4 form C contacts (4 CO contacts)				
Contact material	7 AgNi 90/10, with test button 8 AgNi 90/10 gold plated, with test button 2 AgNi 90/10, without test button 3 AgNi 90/10 gold plated, without test button				
Version	0 Standard, 2.8mm quick connect term. 1 PCB terminals				
Coil	Coil code: please refer to coil versions table				

Other types on request

Product code	Cont. Config.	Cont. material	Version	Coil	Coil	Part number
PT270024	2 form C 2 CO contacts	AgNi 90/10 test button	AMP 2.8 connectors	DC coil	24VDC	4-1419111-2
PT270524				AC coil	24VAC	4-1419111-8
PT270615					115VAC	5-1419111-0
PT270730					230VAC	5-1419111-1
PT270L24				DC coil+LED	24VDC	9-1415001-1
PT270R24				AC coil+LED	24VAC	1415002-1
PT270S15					115VAC	2-1415039-1
PT270T30					230VAC	3-1415002-1
PT271024			PCB terminals	DC coil	24VDC	5-1419111-3
PT271524				AC coil	24VAC	5-1419111-6
PT271615					115VAC	4-1419135-0
PT271730					230VAC	5-1419111-8
PT370024	3 form C 3 CO contacts	AgNi 90/10 test button	AMP 2.8 connectors	DC coil	24VDC	6-1419111-1
PT370524				AC coil	24VAC	6-1419111-6
PT370615					115VAC	6-1419111-8
PT370730					230VAC	6-1419111-9
PT370L24				DC coil+LED	24VDC	5-1415002-1
PT370R24				AC coil+LED	24VAC	7-1415002-1
PT370S15					115VAC	9-1415039-1
PT370T30					230VAC	9-1415002-1
PT371024			PCB terminals	DC coil	24VDC	7-1419111-1
PT371524				AC coil	24VAC	7-1419111-3
PT371615					115VAC	1393154-8
PT371730					230VAC	7-1419111-5
PT570024	4 form C 4 CO contacts	AgNi 90/10 test button	AMP 2.8 connectors	DC coil	24VDC	1-1393154-2
PT570524				AC coil	24VAC	8-1419111-7
PT570615					115VAC	9-1419111-0
PT570730					230VAC	9-1419111-1
PT570L24				DC coil+LED	24VDC	6-1415001-1
PT570LC4				DC coil+LED+PD		7-1415541-0
PT570R24				AC coil+LED	24VAC	7-1415001-1
PT570S15					115VAC	7-1415003-1
PT570T30					230VAC	8-1415001-1
PT571024			PCB terminals	DC coil	24VDC	9-1419111-3
PT571524				AC coil	24VAC	9-1419111-6
PT571615					115VAC	1-1393154-5
PT571730					230VAC	9-1419111-8
PT580024		AgNi 90/10 gold plated test button	AMP 2.8 connectors	DC coil	24VDC	1-1393154-7
PT580524				AC coil	24VAC	2-1393154-1
PT580730					230VAC	2-1393154-2
PT580L24				DC coil+LED	24VDC	5-1415026-1
PT580R24				AC coil+LED	24VAC	6-1415026-1
PT580T30					230VAC	7-1415026-1
PT581024			PCB terminals	DC coil	24VDC	7-1419135-2
PT581730				AC coil	230VAC	2-1393154-3

Mouser Electronics

Authorized Distributor

Click to View Pricing, Inventory, Delivery & Lifecycle Information:

[TE Connectivity:](#)

[PT271730](#)