

# PS8551L4

## Data Sheet

ANALOG OUTPUT TYPE  
 OPTICAL COUPLED ISOLATION AMPLIFIER

R08DS0039EJ0200  
 Rev.2.00  
 Sep 06, 2011

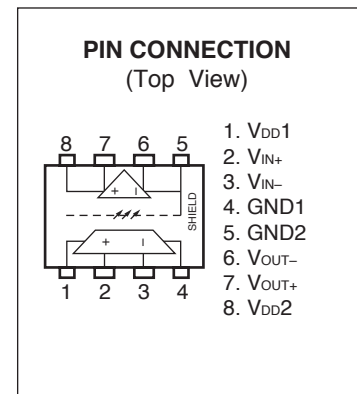
### DESCRIPTION

The PS8551L4 is an optically coupled isolation amplifier that uses an IC with a high-accuracy sigma-delta A/D converter and a GaAlAs light-emitting diode with high-speed response and high luminance efficiency on the input side, and an IC with a high-accuracy D/A converter on the output side.

The PS8551L4 is designed specifically for high common mode transient immunity (CMTI) and high linearity (non-linearity). The PS8551L4 is suitable for current sensing in motor drives.

### FEATURES

- Non-linearity (NL200 = 0.35% MAX.)
- High common mode transient immunity (CMTI = 10 kV/ $\mu$ s MIN.)
- High isolation voltage (BV = 5 000 Vr.m.s.)
- Gain tolerance (G = 7.76 to 8.24 ( $\pm$ 3%))  
 Gain: 8 V/V TYP.
- Package: 8-pin DIP lead bending type (Gull-wing) for long creepage distance for surface mount (L4)
- Embossed tape product: PS8551L4-E3 : 1 000 pcs/reel
- Pb-Free product
- Safety standards
  - UL approved: No. E72422
  - CSA approved: No. CA 101391 (CA5A, CAN/CSA-C22.2 60065, 60950)
  - SEMKO approved: No. 1111155
  - DIN EN60747-5-2 (VDE0884 Part2) approved: No. 40019182 (Option)



### APPLICATIONS

- AC Servo, inverter
- Measurement equipment

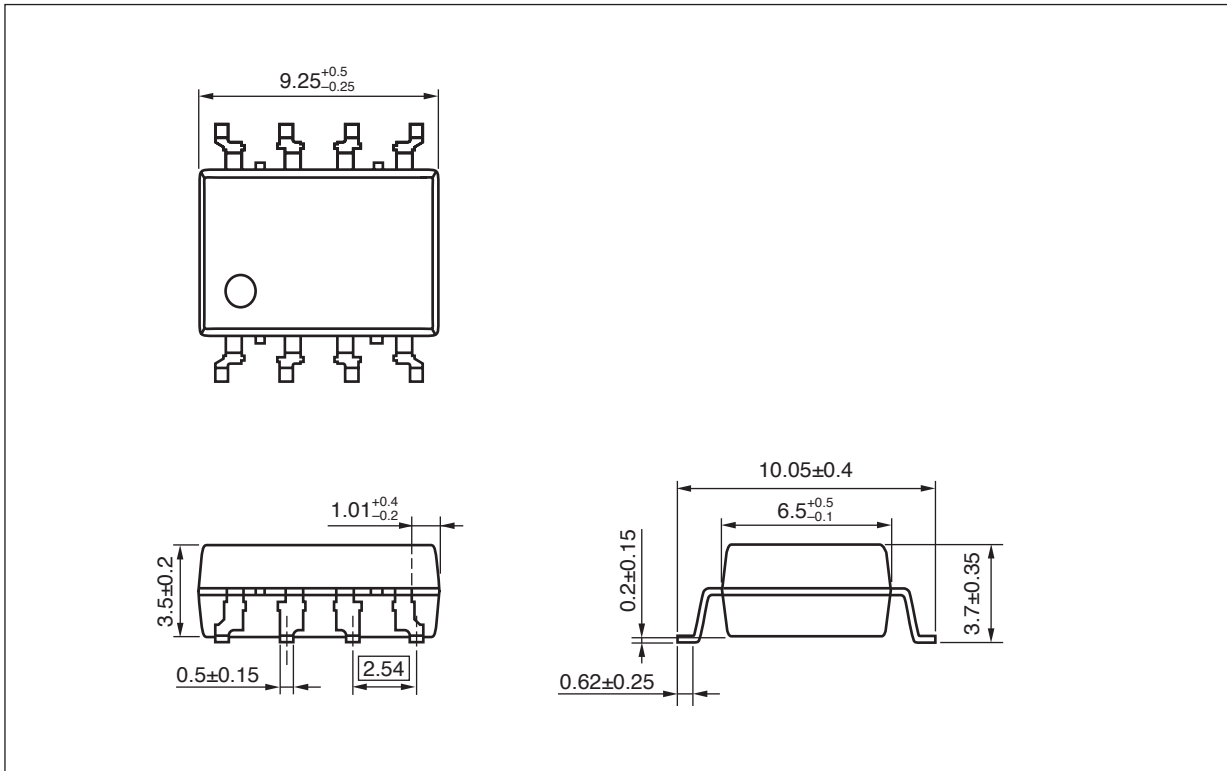
The mark <R> shows major revised points.

The revised points can be easily searched by copying an "<R>" in the PDF file and specifying it in the "Find what:" field.

**PS8551L4**

**PACKAGE DIMENSIONS (UNIT: mm)**

**Lead Bending Type (Gull-wing) For Long Creepage Distance For Surface Mount (L4)**

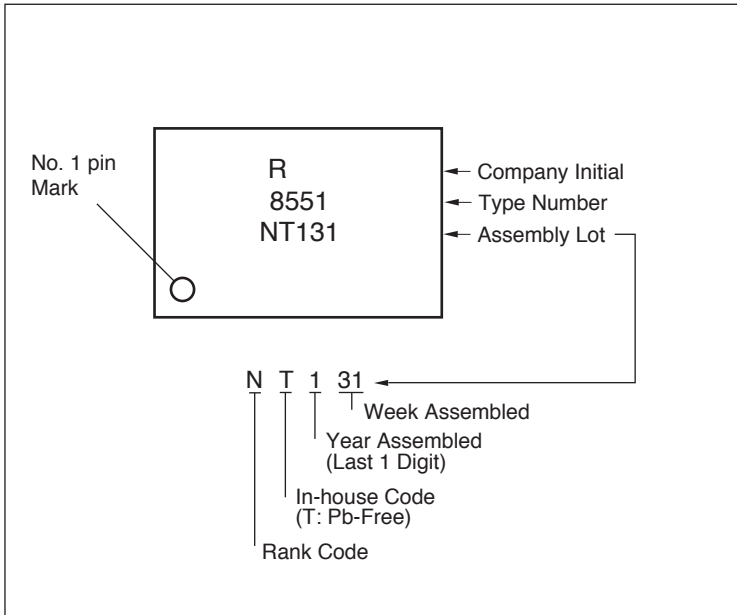


**PHOTOCOUPLER CONSTRUCTION**

Parameter	Unit (MIN.)
Air Distance	8 mm
Outer Creepage Distance	8 mm
Isolation Distance	0.4 mm

**PS8551L4**

<R> **MARKING EXAMPLE**



**ORDERING INFORMATION**

Part Number	Order Number	Solder Plating Specification	Packing Style	Safety Standard Approval	Application Part Number* <sup>1</sup>
PS8551L4	PS8551L4-AX	Pb-Free (Ni/Pd/Au)	Magazine case 50 pcs	Standard products (UL, CSA, SEMKO approved)	PS8551L4
PS8551L4-E3	PS8551L4-E3-AX		Embossed Tape 1 000 pcs/reel		
PS8551L4-V	PS8551L4-V-AX		Magazine case 50 pcs	DIN EN60747-5-2	
PS8551L4-V-E3	PS8551L4-V-E3-AX		Embossed Tape 1 000 pcs/reel	(VDE0884 Part2) Approved (Option)	

\*1 For the application of the Safety Standard, following part number should be used.

## PS8551L4

### ABSOLUTE MAXIMUM RATINGS (T<sub>A</sub> = 25°C, unless otherwise specified)

Parameter	Symbol	Ratings	Unit
Operating Ambient Temperature	T <sub>A</sub>	-40 to +85	°C
Storage Temperature	T <sub>stg</sub>	-55 to +125	°C
Supply Voltage	V <sub>DD1</sub> , V <sub>DD2</sub>	0 to 5.5	V
Input Voltage	V <sub>IN+</sub> , V <sub>IN-</sub>	-2 to V <sub>DD1</sub> +0.5	V
2 Seconds Transient Input Voltage	V <sub>IN+</sub> , V <sub>IN-</sub>	-6 to V <sub>DD1</sub> +0.5	V
Output Voltage	V <sub>OUT+</sub> , V <sub>OUT-</sub>	-0.5 to V <sub>DD2</sub> +0.5	V
Isolation Voltage <sup>*1</sup>	BV	5 000	Vr.m.s.

\*1 AC voltage for 1 minute at T<sub>A</sub> = 25°C, RH = 60% between input and output.  
Pins 1-4 shorted together, 5-8 shorted together.

### RECOMMENDED OPERATING CONDITIONS

Parameter	Symbol	MIN.	MAX.	Unit
Operating Ambient Temperature	T <sub>A</sub>	-40	85	°C
Supply Voltage	V <sub>DD1</sub> , V <sub>DD2</sub>	4.5	5.5	V
Input Voltage (Accurate and Linear) <sup>*1</sup>	V <sub>IN+</sub> , V <sub>IN-</sub>	-200	200	mV

\*1 Using V<sub>IN-</sub> = 0 V (to be connected to GND1) is recommended. Avoid using V<sub>IN-</sub> of 2.5 V or more, because the internal test mode is activated when the voltage V<sub>IN-</sub> reaches more than 2.5 V.

## PS8551L4

### ELECTRICAL CHARACTERISTICS (DC Characteristics)

(TYP.:  $T_A = 25^\circ\text{C}$ ,  $V_{IN+} = V_{IN-} = 0\text{ V}$ ,  $V_{DD1} = V_{DD2} = 5\text{ V}$ ,

MIN., MAX.: refer to RECOMMENDED OPERATING CONDITIONS, unless otherwise specified)

Parameter	Symbol	Conditions	MIN.	TYP.	MAX.	Unit
Input Offset Voltage	$V_{OS}$	$T_A = 25^\circ\text{C}$	-2	0.3	2	mV
			-3		3	
Input Offset Voltage Drift vs. Temperature	$ dV_{OS}/dT_A $	$T_A = 25\text{ to }+85^\circ\text{C}$		3	10	$\mu\text{V}/^\circ\text{C}$
Gain <sup>*1</sup>	G	$-200\text{ mV} \leq V_{IN+} \leq 200\text{ mV}$ , $T_A = 25^\circ\text{C}$	7.76	8	8.24	V/V
Gain Drift vs. Temperature	$ dG/dT_A $			0.00087		V/V $^\circ\text{C}$
$V_{OUT}$ Non-linearity (200 mV) <sup>*2</sup>	NL200	$-200\text{ mV} \leq V_{IN+} \leq 200\text{ mV}$		0.021	0.35	%
$V_{OUT}$ Non-linearity (200 mV) Drift vs. Temperature	$ dNL200/dT_A $			0.0002		%/ $^\circ\text{C}$
$V_{OUT}$ Non-linearity (100 mV) <sup>*2</sup>	NL100	$-100\text{ mV} \leq V_{IN+} \leq 100\text{ mV}$		0.014	0.2	%
Maximum Input Voltage before $V_{OUT}$ Clipping	$ V_{IN+} _{MAX.}$			308		mV
Input Supply Current	$I_{DD1}$	$V_{IN+} = 400\text{ mV}$		16	20	mA
Output Supply Current	$I_{DD2}$	$V_{IN+} = -400\text{ mV}$		10	16	mA
Input Bias Current	$I_{IN+}$	$V_{IN+} = 0\text{ V}$		-0.5	5	$\mu\text{A}$
Input Bias Current Drift vs. Temperature	$ dI_{IN+}/dT_A $			0.45		nA/ $^\circ\text{C}$
Low Level Saturated Output Voltage	$V_{OL}$	$V_{IN+} = -400\text{ mV}$		1.29		V
High Level Saturated Output Voltage	$V_{OH}$	$V_{IN+} = 400\text{ mV}$		3.8		V
Output Voltage ( $V_{IN+} = V_{IN-} = 0\text{ V}$ )	$V_{OCM}$	$V_{IN+} = V_{IN-} = 0\text{ V}$	2.2	2.55	2.8	V
Output Short-circuit Current	$ I_{OSC} $			18.6		mA
Equivalent Input Resistance	$R_{IN}$			320		k $\Omega$
$V_{OUT}$ Output Resistance	$R_{OUT}$			15		$\Omega$
Input DC Common-Mode Rejection Ratio <sup>*3</sup>	CMRR <sub>IN</sub>			76		dB

\*1 The differential output voltage ( $V_{OUT+} - V_{OUT-}$ ) with respect to the differential input voltage ( $V_{IN+} - V_{IN-}$ ), where  $V_{IN+} = -200\text{ mV}$  to  $200\text{ mV}$  and  $V_{IN-} = 0\text{ V}$  is measured under the circuit shown in **Fig. 2 NL200, G Test Circuit**. Upon the resulting chart, the gain is defined as the slope of the optimum line obtained by using the method of least squares.

\*2 The differential output voltage ( $V_{OUT+} - V_{OUT-}$ ) with respect to the differential input voltage ( $V_{IN+} - V_{IN-}$ ) is measured under the circuit shown in **Fig. 2 NL200, G Test Circuit**. Upon the resulting chart, the optimum line is obtained by using the method of least squares. Non-linearity is defined as the ratio (%) of the optimum line obtained by dividing [Half of the peak to peak value of the (residual) deviation] by [full-scale differential output voltage].

For example, if the differential output voltage is 3.2 V, and the peak to peak value of the (residual) deviation is 22.4 mV, while the input  $V_{IN+}$  is  $\pm 200\text{ mV}$ , the output non-linearity is obtained as follows:

$$NL200 = 22.4 / (2 \times 3200) = 0.35\%$$

\*3 CMRR<sub>IN</sub> is defined as the ratio of the differential signal gain (when the differential signal is applied between the input pins) to the common-mode signal gain (when both input pins are connected and the signal is applied). This value is indicated in dB.

<R>

## PS8551L4

### ELECTRICAL CHARACTERISTICS (AC Characteristics)

(TYP.:  $T_A = 25^\circ\text{C}$ ,  $V_{IN+} = V_{IN-} = 0\text{ V}$ ,  $V_{DD1} = V_{DD2} = 5\text{ V}$ ,

MIN., MAX.: refer to RECOMMENDED OPERATING CONDITIONS, unless otherwise specified)

Parameter	Symbol	Conditions	MIN.	TYP.	MAX.	Unit
$V_{OUT}$ Bandwidth (-3 dB)	$f_c$	$V_{IN+} = 200\text{ mV}_{p-p}$ , sine wave	50	100		kHz
$V_{OUT}$ Noise	$N_{OUT}$	$V_{IN+} = 0\text{ V}$		31.5		mVr.m.s.
$V_{IN}$ to $V_{OUT}$ Signal Delay (50 to 10%)	$t_{PD10}$	$V_{IN+} = 0$ to 150 mV step		2.03	3.3	$\mu\text{s}$
$V_{IN}$ to $V_{OUT}$ Signal Delay (50 to 50%)	$t_{PD50}$			4.01	5.6	
$V_{IN}$ to $V_{OUT}$ Signal Delay (50 to 90%)	$t_{PD90}$			6.02	9.9	
$V_{OUT}$ Rise Time/Fall Time (10 to 90%)	$t_r/t_f$	$V_{IN+} = 0$ to 150 mV step		3.53	6.6	$\mu\text{s}$
Common Mode Transient Immunity <sup>*1</sup>	CMTI	$V_{CM} = 0.5\text{ kV}$ , $T_A = 25^\circ\text{C}$	10	25		$\text{kV}/\mu\text{s}$
Power Supply Noise Rejection <sup>*2</sup>	PSR	$f = 1\text{ MHz}$		100		mVr.m.s.

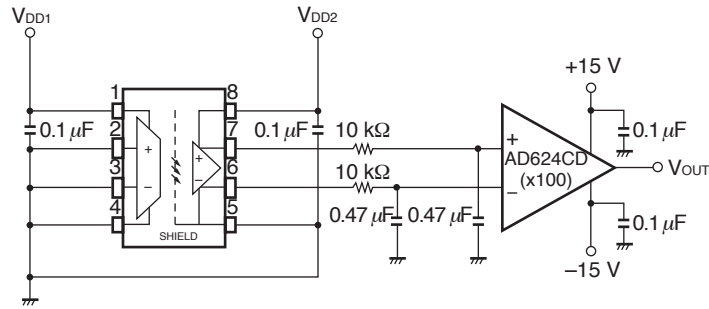
\*1 CMTI is tested by applying a pulse that rises and falls suddenly ( $V_{CM} = 0.5\text{ kV}$ ) between GND1 on the input side and GND2 on the output side (pins 4 and 5) by using the circuit shown in **Fig. 9 CMTI Test Circuit**. CMTI is defined at the point where the differential output voltage ( $V_{OUT+} - V_{OUT-}$ ) fluctuates 200 mV ( $>1\ \mu\text{s}$ ) or more from the average output voltage.

\*2 This is the value of the transient voltage at the differential output when 1  $V_{p-p}$ , 1 MHz, and 40 ns rise/fall time square wave is applied to both  $V_{DD1}$  and  $V_{DD2}$ .

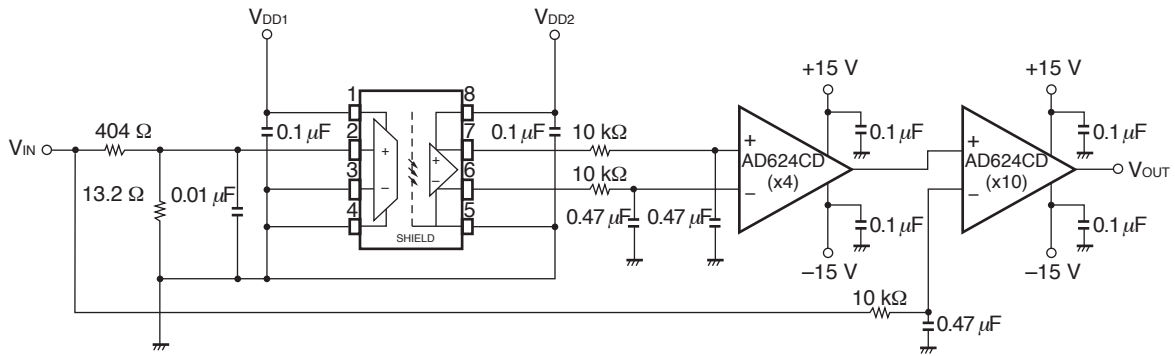
**PS8551L4**

**TEST CIRCUIT**

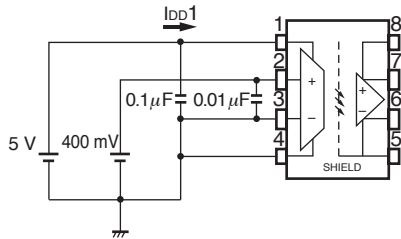
**Fig. 1 Vos Test Circuit**



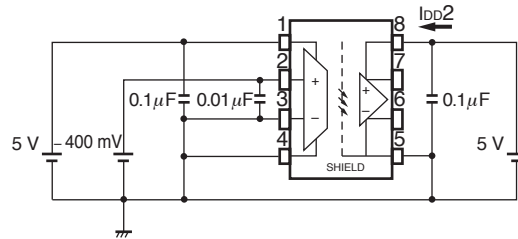
**Fig. 2 NL200, G Test Circuit**



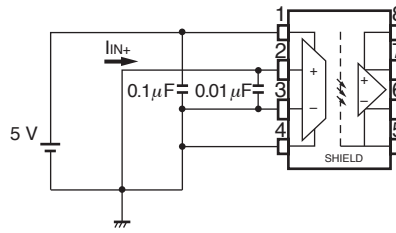
**Fig. 3 I<sub>DD1</sub> Test Circuit**



**Fig. 4 I<sub>DD2</sub> Test Circuit**

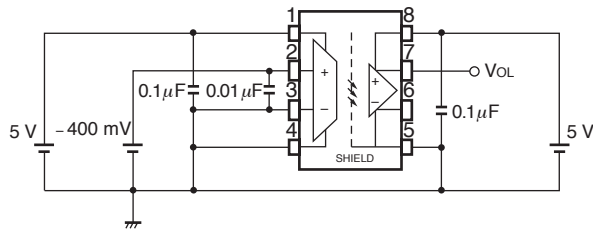


**Fig. 5**  $I_{IN+}$  Test Circuit

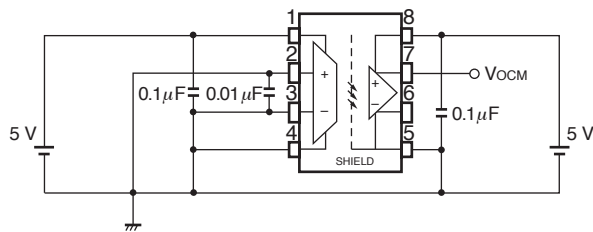


**Fig. 6**  $V_{OUT}$  Test Circuit

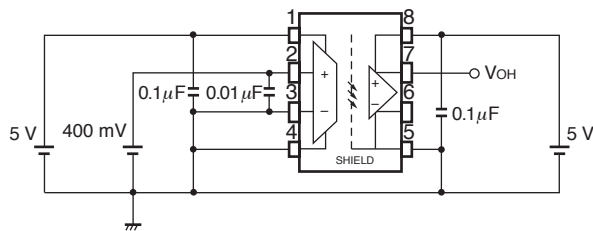
**$V_{OL}$**



**$V_{OCM}$**

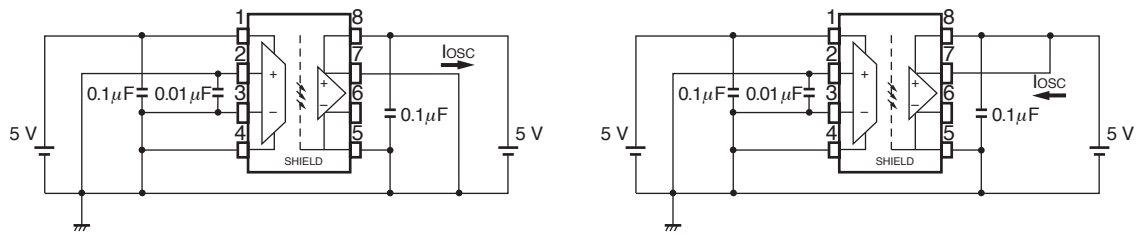


**$V_{OH}$**

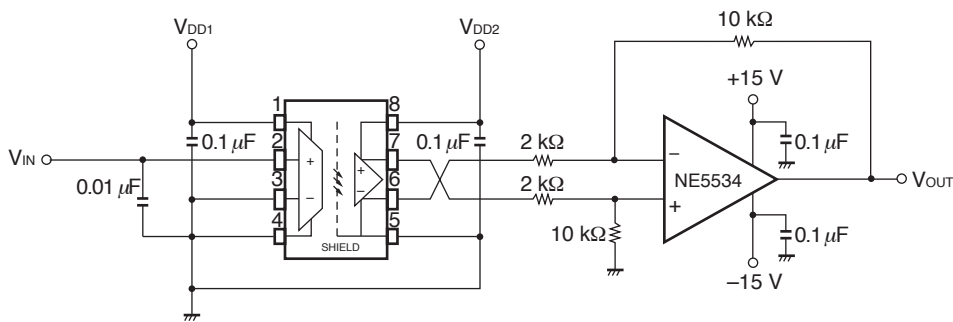




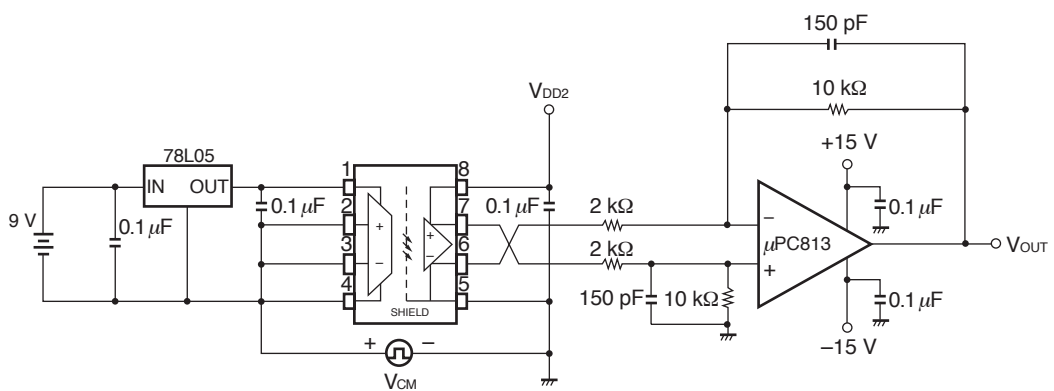
**Fig. 7 Iloscl Test Circuit**



**Fig. 8 tPD Test Circuit**



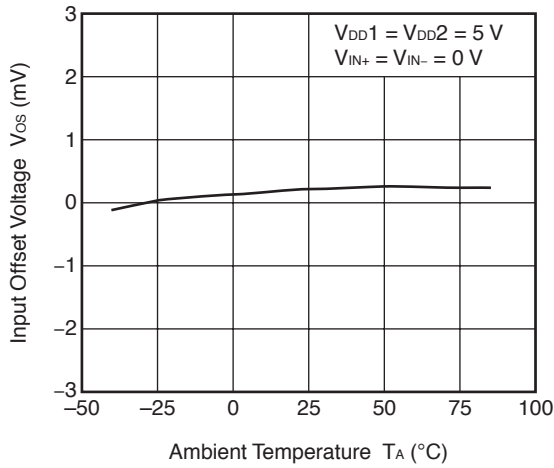
**Fig. 9 CMTI Test Circuit**



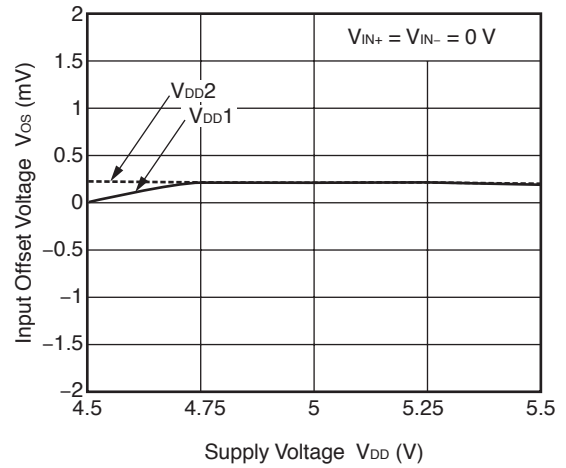
**PS8551L4**

**TYPICAL CHARACTERISTICS (T<sub>A</sub> = 25°C, unless otherwise specified)**

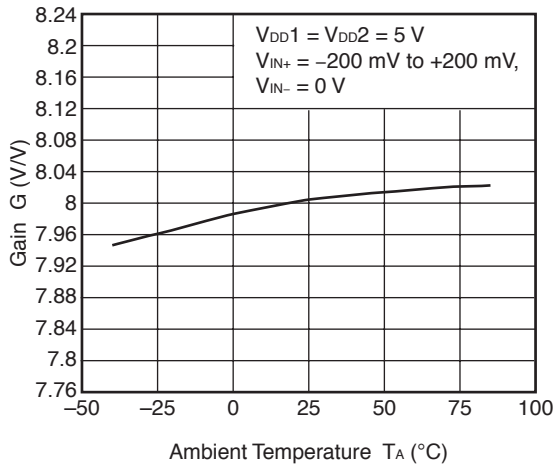
**INPUT OFFSET VOLTAGE vs. AMBIENT TEMPERATURE**



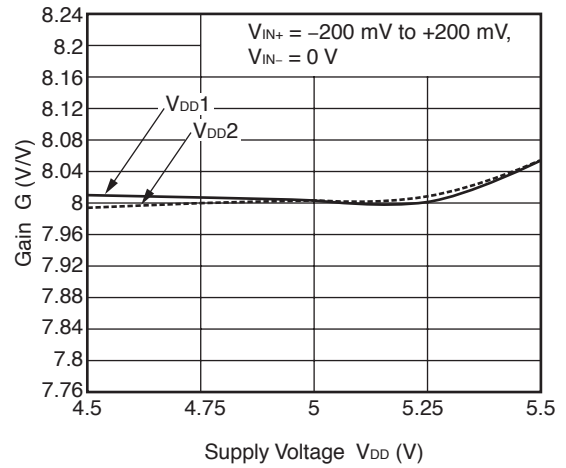
**INPUT OFFSET VOLTAGE vs. SUPPLY VOLTAGE**



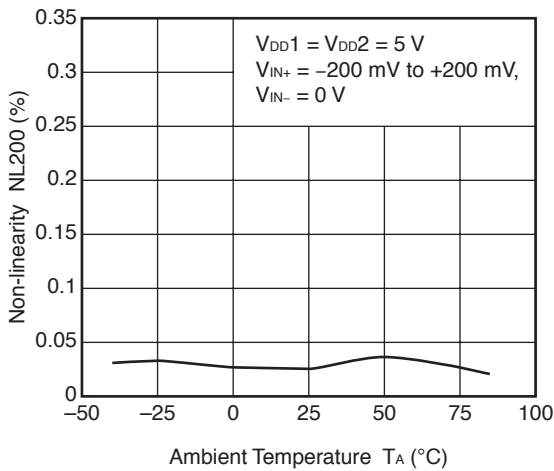
**GAIN vs. AMBIENT TEMPERATURE**



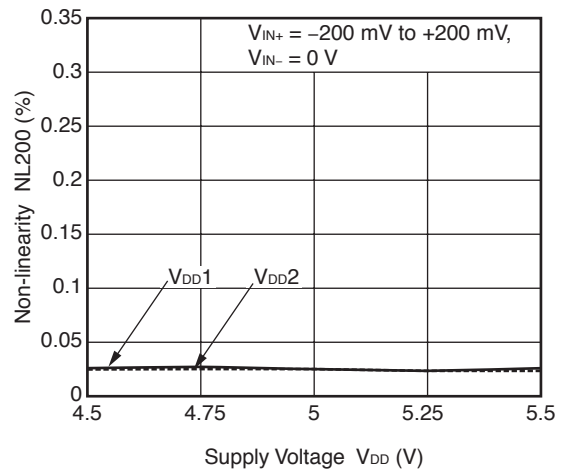
**GAIN vs. SUPPLY VOLTAGE**



**NON-LINEARITY vs. AMBIENT TEMPERATURE**



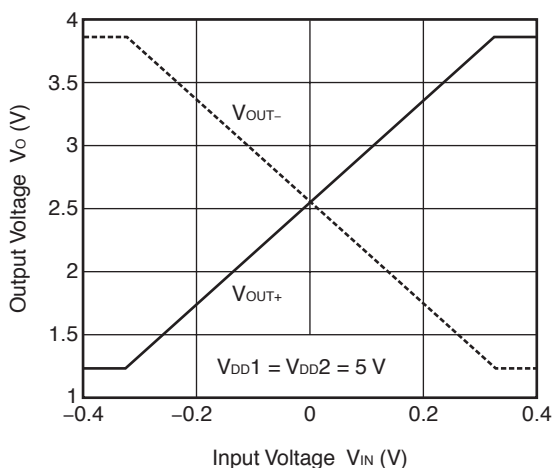
**NON-LINEARITY vs. SUPPLY VOLTAGE**



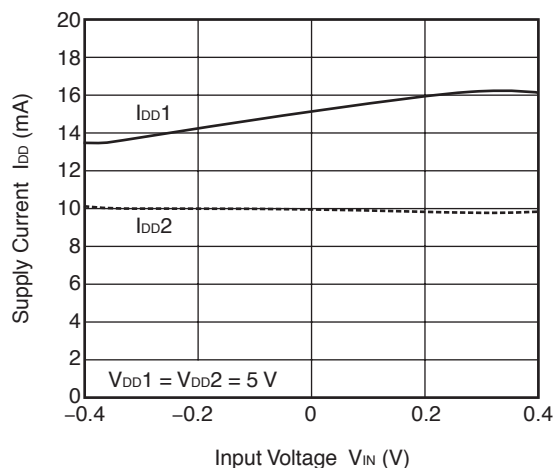
**Remark** The graphs indicate nominal characteristics.

**PS8551L4**

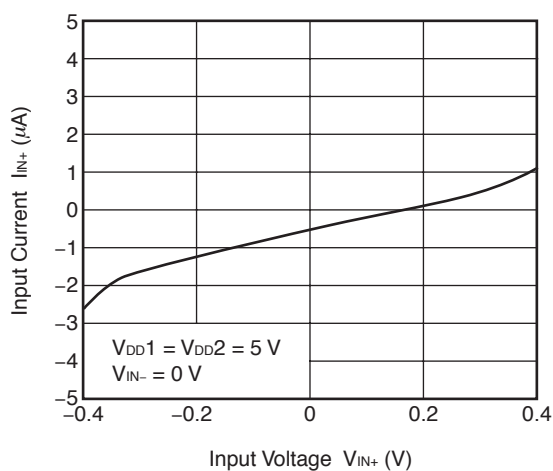
**INPUT VOLTAGE vs. OUTPUT VOLTAGE**



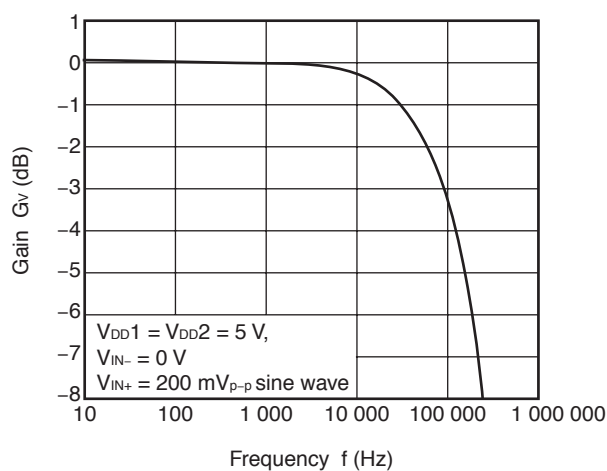
**SUPPLY CURRENT vs. INPUT VOLTAGE**



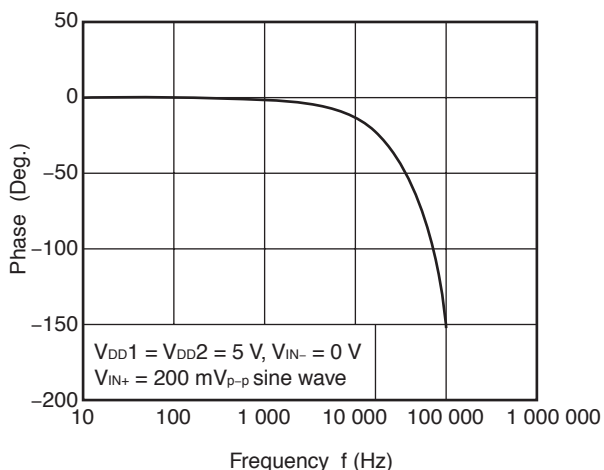
**INPUT CURRENT vs. INPUT VOLTAGE**



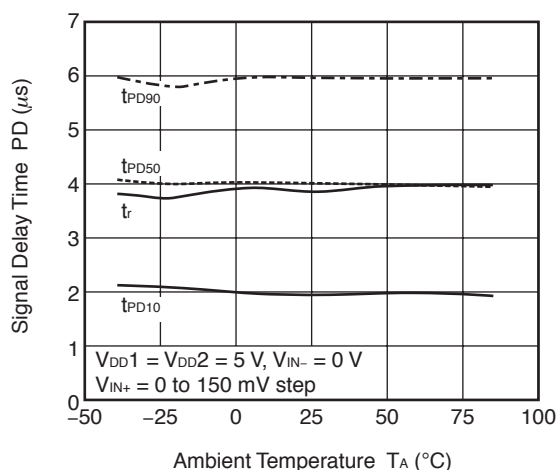
**GAIN vs. FREQUENCY**



**PHASE vs. FREQUENCY**



**SIGNAL DELAY TIME vs. AMBIENT TEMPERATURE**

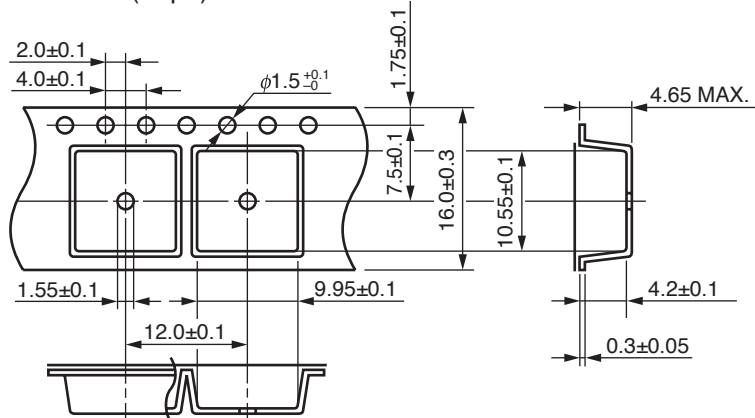


**Remark** The graphs indicate nominal characteristics.

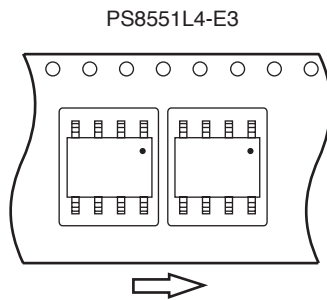
**PS8551L4**

**TAPING SPECIFICATIONS (UNIT: mm)**

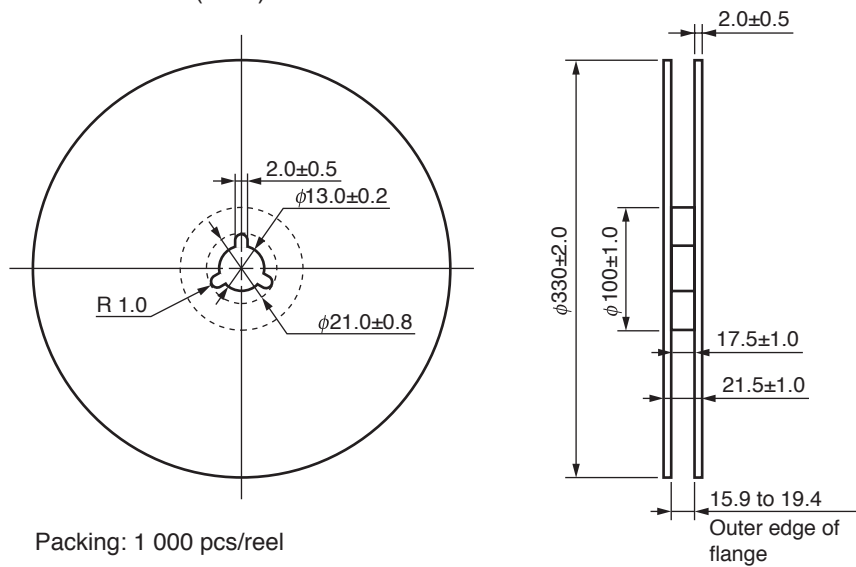
Outline and Dimensions (Tape)



Tape Direction

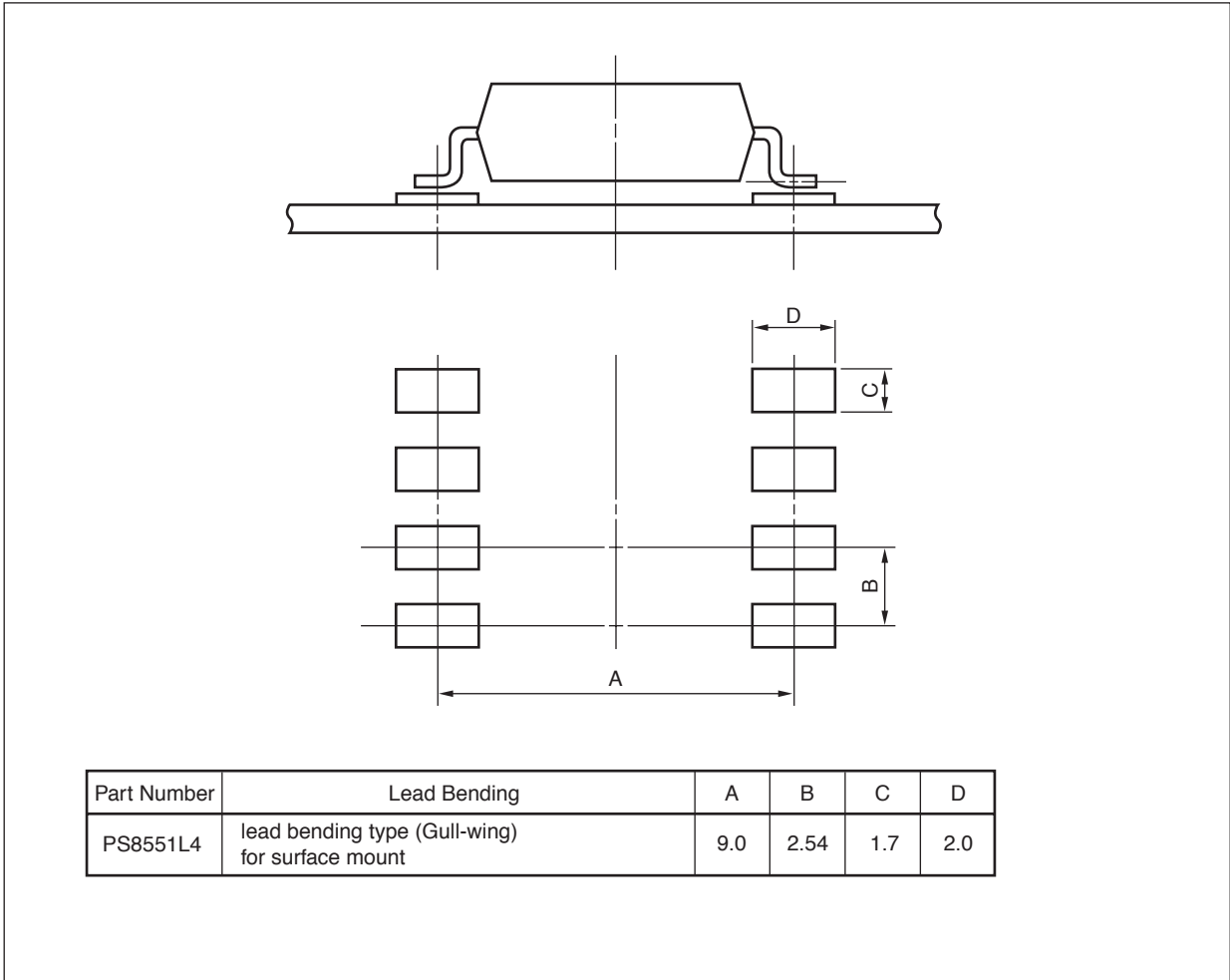


Outline and Dimensions (Reel)



**PS8551L4**

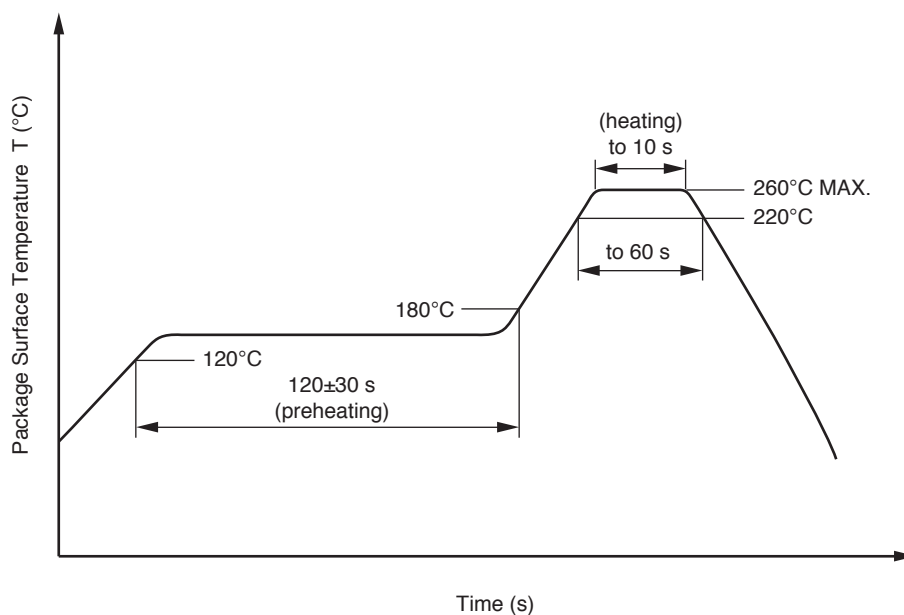
**RECOMMENDED MOUNT PAD DIMENSIONS (UNIT: mm)**



**PS8551L4****NOTES ON HANDLING****1. Recommended soldering conditions****(1) Infrared reflow soldering**

- Peak reflow temperature 260°C or below (package surface temperature)
- Time of peak reflow temperature 10 seconds or less
- Time of temperature higher than 220°C 60 seconds or less
- Time to preheat temperature from 120 to 180°C 120±30 s
- Number of reflows Three
- Flux Rosin flux containing small amount of chlorine (The flux with a maximum chlorine content of 0.2 Wt% is recommended.)

Recommended Temperature Profile of Infrared Reflow

**(2) Wave soldering**

- Temperature 260°C or below (molten solder temperature)
- Time 10 seconds or less
- Preheating conditions 120°C or below (package surface temperature)
- Number of times One (Allowed to be dipped in solder including plastic mold portion.)
- Flux Rosin flux containing small amount of chlorine (The flux with a maximum chlorine content of 0.2 Wt% is recommended.)

**(3) Soldering by Soldering Iron**

- Peak Temperature (lead part temperature) 350°C or below
- Time (each pins) 3 seconds or less
- Flux Rosin flux containing small amount of chlorine (The flux with a maximum chlorine content of 0.2 Wt% is recommended.)

(a) Soldering of leads should be made at the point 1.5 to 2.0 mm from the root of the lead

## PS8551L4

---

### (4) Cautions

- Fluxes

Avoid removing the residual flux with freon-based and chlorine-based cleaning solvent.

### 2. Cautions regarding noise

Be aware that when voltage is applied suddenly between the photocoupler's input and output at startup, the output transistor may enter the on state, even if the voltage is within the absolute maximum ratings.

### USAGE CAUTIONS

1. This product is weak for static electricity by designed with high-speed integrated circuit so protect against static electricity when handling.
2. Board designing
  - (1) By-pass capacitor of more than 0.1  $\mu\text{F}$  is used between  $V_{\text{CC}}$  and GND near device. Also, ensure that the distance between the leads of the photocoupler and capacitor is no more than 10 mm.
  - (2) Keep the pattern connected the input ( $V_{\text{IN+}}$ ,  $V_{\text{IN-}}$ ) and the output ( $V_{\text{OUT+}}$ ,  $V_{\text{OUT-}}$ ), respectively, as short as possible.
  - (3) Do not connect any routing to the portion of the frame exposed between the pins on the package of the photocoupler. If connected, it will affect the photocoupler's internal voltage and the photocoupler will not operate normally.
  - (4) Because the maximum frequency of the signal input to the photocoupler must be lower than the allowable frequency band, be sure to connect an anti-aliasing filter (an RC filter with  $R = 68 \Omega$  and  $C = 0.01 \mu\text{F}$ , for example).
  - (5) The signals output from the PS8551 include noise elements such as chopping noise and quantization noise generated internally. Therefore, be sure to restrict the output frequency to the required bandwidth by adding a low-pass filter function (an RC filter with  $R = 10 \text{ k}\Omega$  and  $C = 150 \text{ pF}$ , for example) to the operational amplifier (post amplifier) in the next stage to the PS8551.
3. Avoid storage at a high temperature and high humidity.

**PS8551L4**
**SPECIFICATION OF VDE MARKS LICENSE DOCUMENT**

Parameter	Symbol	Spec.	Unit
Climatic test class (IEC 60068-1/DIN EN 60068-1)		40/085/21	
Dielectric strength maximum operating isolation voltage	$U_{IORM}$	1 130	$V_{peak}$
Test voltage (partial discharge test, procedure a for type test and random test) $U_{pr} = 1.5 \times U_{IORM}$ , $P_d < 5$ pC	$U_{pr}$	1 695	$V_{peak}$
Test voltage (partial discharge test, procedure b for all devices) $U_{pr} = 1.875 \times U_{IORM}$ , $P_d < 5$ pC	$U_{pr}$	2 119	$V_{peak}$
Highest permissible overvoltage	$U_{TR}$	8 000	$V_{peak}$
Degree of pollution (DIN EN 60664-1 VDE0110 Part 1)		2	
Comparative tracking index (IEC 60112/DIN EN 60112 (VDE 0303 Part 11))	CTI	175	
Material group (DIN EN 60664-1 VDE0110 Part 1)		III a	
Storage temperature range	$T_{stg}$	-55 to +125	°C
Operating temperature range	$T_A$	-40 to +85	°C
Isolation resistance, minimum value $V_{IO} = 500$ V dc at $T_A = 25^\circ\text{C}$ $V_{IO} = 500$ V dc at $T_A$ MAX. at least $100^\circ\text{C}$	Ris MIN. Ris MIN.	$10^{12}$ $10^{11}$	$\Omega$ $\Omega$
Safety maximum ratings (maximum permissible in case of fault, see thermal derating curve)			
Package temperature	$T_{si}$	175	°C
Current (input current $I_F$ , $P_{si} = 0$ )	$I_{si}$	400	mA
Power (output or total power dissipation)	$P_{si}$	700	mW
Isolation resistance $V_{IO} = 500$ V dc at $T_A = T_{si}$	Ris MIN.	$10^9$	$\Omega$



<b>Caution</b>	GaAs Products	<p>This product uses gallium arsenide (GaAs). GaAs vapor and powder are hazardous to human health if inhaled or ingested, so please observe the following points.</p> <ul style="list-style-type: none"><li>• Follow related laws and ordinances when disposing of the product. If there are no applicable laws and/or ordinances, dispose of the product as recommended below.<ol style="list-style-type: none"><li>1. Commission a disposal company able to (with a license to) collect, transport and dispose of materials that contain arsenic and other such industrial waste materials.</li><li>2. Exclude the product from general industrial waste and household garbage, and ensure that the product is controlled (as industrial waste subject to special control) up until final disposal.</li></ol></li><li>• Do not burn, destroy, cut, crush, or chemically dissolve the product.</li><li>• Do not lick the product or in any way allow it to enter the mouth.</li></ul>
----------------	---------------	--

<b>Revision History</b>	<b>PS8551L4 Data Sheet</b>
-------------------------	----------------------------

Rev.	Date	Description	
		Page	Summary
-	Sep 2007	-	Previous No. :PN10670EJ01V0DS
1.00	Jun 14, 2011	Throughout	Preliminary Data Sheet -> Data Sheet
		Throughout	Safety standards approved
		p.3	Modification of <b>MARKING EXAMPLE</b> Addition of <b>ORDERING INFORMATION</b>
		p.4	Modification of <b>ABSOLUTE MAXIMUM RATINGS</b> Modification of <b>RECOMMENDED OPERATING CONDITIONS</b>
		p.5	Modification of <b>ELECTRICAL CHARACTERISTICS (DC Characteristics)</b>
		p.6	Modification of <b>SWITCHING CHARACTERISTICS (ADC Characteristics)</b>
		pp.7 to 9	Addition of <b>TEST CIRCUIT</b>
		pp.10, 11	Addition of <b>TYPICAL CHARACTERISTICS</b>
		p.13	Addition of <b>RECOMMENDED MOUNT</b>
		p.15	Modification of <b>USAGE CAUTIONS</b>
2.00	Sep 06, 2011	p.3	Modification of <b>MARKING EXAMPLE</b>
		p.5	Modification of <b>ELECTRICAL CHARACTERISTICS (DC Characteristics)</b> CMRR <sub>IN</sub>

All trademarks and registered trademarks are the property of their respective owners.

## NOTICE

1. Descriptions of circuits, software and other related information in this document are provided only to illustrate the operation of semiconductor products and application examples. You are fully responsible for the incorporation of these circuits, software, and information in the design of your equipment. California Eastern Laboratories and Renesas Electronics assumes no responsibility for any losses incurred by you or third parties arising from the use of these circuits, software, or information.
2. California Eastern Laboratories has used reasonable care in preparing the information included in this document, but California Eastern Laboratories does not warrant that such information is error free. California Eastern Laboratories and Renesas Electronics assumes no liability whatsoever for any damages incurred by you resulting from errors in or omissions from the information included herein.
3. California Eastern Laboratories and Renesas Electronics do not assume any liability for infringement of patents, copyrights, or other intellectual property rights of third parties by or arising from the use of Renesas Electronics products or technical information described in this document. No license, express, implied or otherwise, is granted hereby under any patents, copyrights or other intellectual property rights of California Eastern Laboratories or Renesas Electronics or others.
4. You should not alter, modify, copy, or otherwise misappropriate any Renesas Electronics product, whether in whole or in part. California Eastern Laboratories and Renesas Electronics assume no responsibility for any losses incurred by you or third parties arising from such alteration, modification, copy or otherwise misappropriation of Renesas Electronics product.
5. Renesas Electronics products are classified according to the following two quality grades: "Standard" and "High Quality". The recommended applications for each Renesas Electronics product depends on the product's quality grade, as indicated below. "Standard": Computers; office equipment; communications equipment; test and measurement equipment; audio and visual equipment; home electronic appliances; machine tools; personal electronic equipment; and industrial robots etc. "High Quality": Transportation equipment (automobiles, trains, ships, etc.); traffic control systems; anti-disaster systems; anti-crime systems; and safety equipment etc. Renesas Electronics products are neither intended nor authorized for use in products or systems that may pose a direct threat to human life or bodily injury (artificial life support devices or systems, surgical implantations etc.), or may cause serious property damages (nuclear reactor control systems, military equipment etc.). You must check the quality grade of each Renesas Electronics product before using it in a particular application. You may not use any Renesas Electronics product for any application for which it is not intended. California Eastern Laboratories and Renesas Electronics shall not be in any way liable for any damages or losses incurred by you or third parties arising from the use of any Renesas Electronics product for which the product is not intended by California Eastern Laboratories or Renesas Electronics.
6. You should use the Renesas Electronics products described in this document within the range specified by California Eastern Laboratories, especially with respect to the maximum rating, operating supply voltage range, movement power voltage range, heat radiation characteristics, installation and other product characteristics. California Eastern Laboratories shall have no liability for malfunctions or damages arising out of the use of Renesas Electronics products beyond such specified ranges.
7. Although Renesas Electronics endeavors to improve the quality and reliability of its products, semiconductor products have specific characteristics such as the occurrence of failure at a certain rate and malfunctions under certain use conditions. Further, Renesas Electronics products are not subject to radiation resistance design. Please be sure to implement safety measures to guard them against the possibility of physical injury, and injury or damage caused by fire in the event of the failure of a Renesas Electronics product, such as safety design for hardware and software including but not limited to redundancy, fire control and malfunction prevention, appropriate treatment for aging degradation or any other appropriate measures. Because the evaluation of microcomputer software alone is very difficult, please evaluate the safety of the final products or systems manufactured by you.
8. Please contact a California Eastern Laboratories sales office for details as to environmental matters such as the environmental compatibility of each Renesas Electronics product. Please use Renesas Electronics products in compliance with all applicable laws and regulations that regulate the inclusion or use of controlled substances, including without limitation, the EU RoHS Directive. California Eastern Laboratories and Renesas Electronics assume no liability for damages or losses occurring as a result of your noncompliance with applicable laws and regulations.
9. Renesas Electronics products and technology may not be used for or incorporated into any products or systems whose manufacture, use, or sale is prohibited under any applicable domestic or foreign laws or regulations. You should not use Renesas Electronics products or technology described in this document for any purpose relating to military applications or use by the military, including but not limited to the development of weapons of mass destruction. When exporting the Renesas Electronics products or technology described in this document, you should comply with the applicable export control laws and regulations and follow the procedures required by such laws and regulations.
10. It is the responsibility of the buyer or distributor of California Eastern Laboratories, who distributes, disposes of, or otherwise places the Renesas Electronics product with a third party, to notify such third party in advance of the contents and conditions set forth in this document, California Eastern Laboratories and Renesas Electronics assume no responsibility for any losses incurred by you or third parties as a result of unauthorized use of Renesas Electronics products.
11. This document may not be reproduced or duplicated in any form, in whole or in part, without prior written consent of California Eastern Laboratories.
12. Please contact a California Eastern Laboratories sales office if you have any questions regarding the information contained in this document or Renesas Electronics products, or if you have any other inquiries.

**NOTE 1:** "Renesas Electronics" as used in this document means Renesas Electronics Corporation and also includes its majority-owned subsidiaries.

**NOTE 2:** "Renesas Electronics product(s)" means any product developed or manufactured by or for Renesas Electronics.

**NOTE 3:** Products and product information are subject to change without notice.

**CEL Headquarters** • 4590 Patrick Henry Drive, Santa Clara, CA 95054 • Phone (408) 919-2500 • [www.cel.com](http://www.cel.com)

For a complete list of sales offices, representatives and distributors,  
Please visit our website: [www.cel.com/contactus](http://www.cel.com/contactus)

# Mouser Electronics

Authorized Distributor

Click to View Pricing, Inventory, Delivery & Lifecycle Information:

[CEL:](#)

[PS8551L4-AX](#)