

SERIES: V78-500-SMT | **DESCRIPTION:** NON-ISOLATED SWITCHING REGULATOR

FEATURES

- 500 mA current output
- high efficiency up to 96%
- no heat sink required
- SMT package
- remote on/off control
- low ripple and noise
- short circuit protection, thermal shutdown
- wide temperature (-40°C~+85°C)

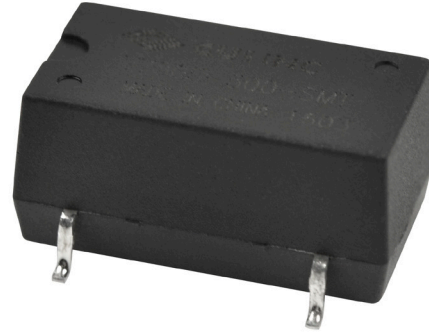

MODEL	input voltage		output voltage (Vdc)	output current (mA)	output power max (W)	ripple and noise ¹ max (mVp-p)	efficiency	
	typ (Vdc)	range (Vdc)					Vin min (%)	Vin max (%)
V7803-500-SMT	12	4.5 ~ 28	3.3	500	1.65	25	90	75
V7805-500-SMT	12	6 ~ 28	5	500	2.5	25	94	81
V7812-500-SMT ²	24	14 ~ 28	12	500	6	25	95	90
V7815-500-SMT ²	24	17 ~ 28	15	500	7.5	25	96	92

Notes: 1. ripple & noise are measured at 20 MHz BW with 1 μF ceramic cap and 10 μF electrolytic capacitors on the output
 2. must operate with a minimum of 5% loading

PART NUMBER KEY

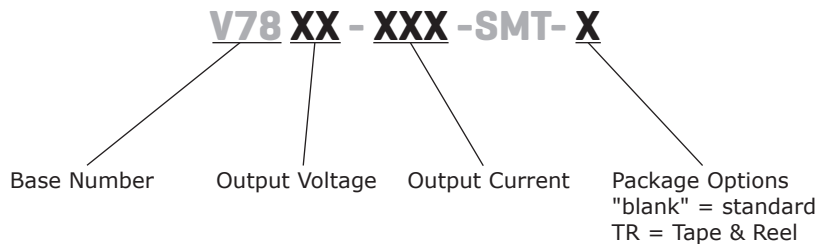

INPUT

parameter	conditions/description	min	typ	max	units
input voltage	3.3 Vdc output	4.5	12	28	Vdc
	5 Vdc output	6	12	28	Vdc
	12 Vdc output	14	24	28	Vdc
	15Vdc output	17	24	28	Vdc
remote on/off shutdown threshold voltage		1.1	1.25	1.4	Vdc
on/off control current	on: open or $1.5 < V_c \leq 6V$ off: GND or $0V < V_c < 1V$		2		μA
shutdown input current			15	30	μA

OUTPUT

parameter	conditions/description	min	typ	max	units
max capacitive load				1000	μF
line regulation	measured from low line to high line at 100% load		± 0.2	± 0.5	%
load regulation	measured from 10% to full load at nominal input		± 0.3	± 0.75	%
voltage accuracy	measured from low line to high line at 100% load		± 2	± 3	%
adjustability ¹	see application notes				
temperature coefficient				± 0.02	%/ $^{\circ}C$

Notes: 1. output voltage adjustment must meet $V_{in} - V_o > 2V$ requirement

PROTECTIONS

parameter	conditions/description	min	typ	max	units
short circuit protection	hiccup, continuous, automatic recovery				
thermal shutdown	internal IC junction		160		$^{\circ}C$
current limit			1.8		A

SAFETY AND COMPLIANCE

parameter	conditions/description	min	typ	max	units
RoHS	2011/65/EU				
MTBF	as per MIL-HDBK-217F, 25 $^{\circ}C$	2,000,000			hours

ENVIRONMENTAL

parameter	conditions/description	min	typ	max	units
case operating temperature				100	$^{\circ}C$
operating temperature	see derating curve	-40		85	$^{\circ}C$
storage temperature		-55		125	$^{\circ}C$
storage humidity				95	%
hand soldering	for 10 seconds			300	$^{\circ}C$
reflow soldering	refer to IPC/JEDEC J-STD-020D.1			240	$^{\circ}C$

DERATING CURVES

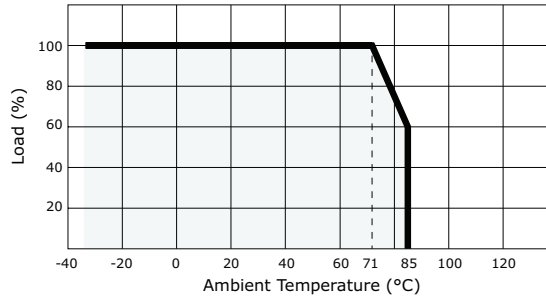

MECHANICAL

parameter	conditions/description	min	typ	max	units
dimensions	15.24 x 8.30 x 7.25 (0.600 x 0.327 x 0.285 inch)				mm
case material	plastic (UL94-V0)				
weight			2.3		g

MECHANICAL DRAWING

units: mm [in]
 pin tolerance: ± 0.10 mm [± 0.004 in]
 general tolerance: ± 0.25 mm [± 0.010 in]

PIN CONNECTIONS	
1	Vin
5	Vout
6	Vadj
7	GND
9	GND
10	On/Off

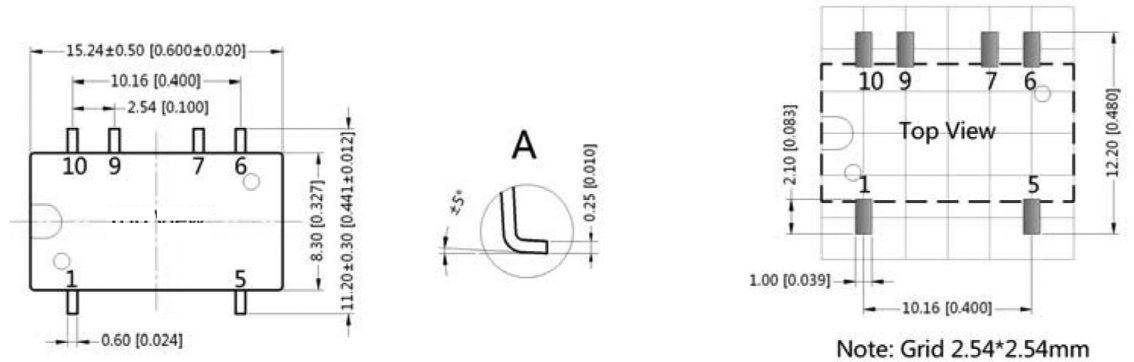

PACKAGING DIMENSIONS

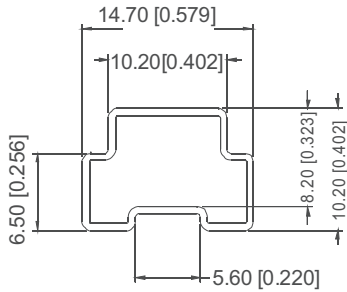

Taping dimension:

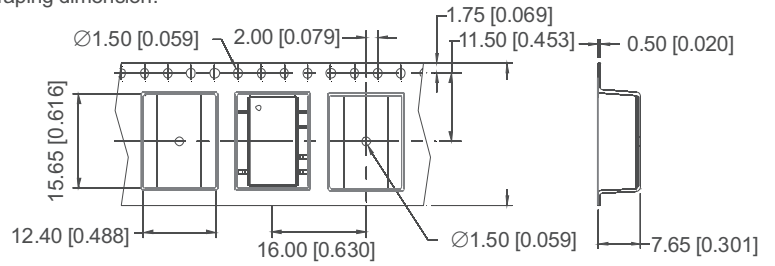

Taping reel dimension:

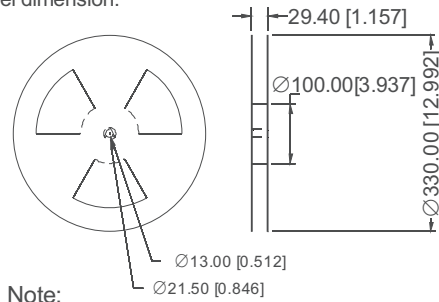

Note:
Unit :mm[inch]
General tolerances: $\pm 0.50\text{mm}[\pm 0.020\text{inch}]$
Devices per reel quantity:500pcs

Note:
Unit :mm[inch]
General tolerances: $\pm 0.50\text{mm}[\pm 0.020\text{inch}]$

L=530mm[20.866inch] Tube Quantity: 33pcs
L=220mm[8.661inch] Tube Quantity: 13pcs

TYPICAL APPLICATION CIRCUIT

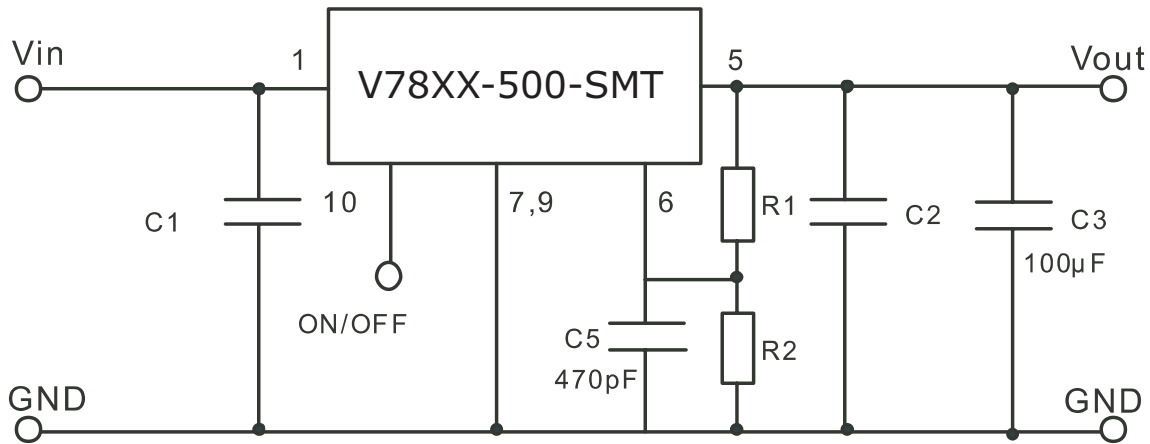

1. C1, C2: Use ceramic capacitors (see table below); C3: For best performance, use a 100 μF or more capacitor.
2. C1, C2, & C3 are required and should be placed close to the pins of the converter, with shortest possible leads.
3. R1 is used when trimming down. R2 is used when trimming up.
4. No parallel connection or plug and play.

Part Number	C1 (ceramic capacitor)	C2 (ceramic capacitor)
V7803-500-SMT	10 $\mu\text{F}/50\text{V}$	22 $\mu\text{F}/16\text{V}$
V7805-500-SMT	10 $\mu\text{F}/50\text{V}$	22 $\mu\text{F}/16\text{V}$
V7812-500-SMT	10 $\mu\text{F}/50\text{V}$	10 $\mu\text{F}/25\text{V}$
V7815-500-SMT	10 $\mu\text{F}/50\text{V}$	10 $\mu\text{F}/25\text{V}$

OUTPUT TRIMMING

Part Name	Vo nom	Trim Down	Trim Up
		R1(KΩ)	R2(KΩ)
V7803-500-SMT	3.3V	$= \frac{61 \cdot V_o - 75.10}{3.3 - V_o}$	$= \frac{75.10 - 10 \cdot V_o}{V_o - 3.3}$
V7805-500-SMT	5.0V	$= \frac{61 \cdot V_o - 91.52}{5.0 - V_o}$	$= \frac{91.52 - 10 \cdot V_o}{V_o - 5.0}$
V7812-500-SMT	12V	$= \frac{71 \cdot V_o - 287.02}{12 - V_o}$	$= \frac{287.02 - 20 \cdot V_o}{V_o - 12}$
V7815-500-SMT	15V	$= \frac{66 \cdot V_o - 269.37}{15 - V_o}$	$= \frac{269.37 - 15 \cdot V_o}{V_o - 15}$

To trim the output of the device input the desired output voltage (Vo) into the proper equation. R1 trims the output voltage down and R2 trims the voltage up. If not using the trim feature R1 and R2 are left open. Make sure that the desired output voltage is within the trim range.

TEST CIRCUIT

1) Efficiency and Output Voltage Ripple Test

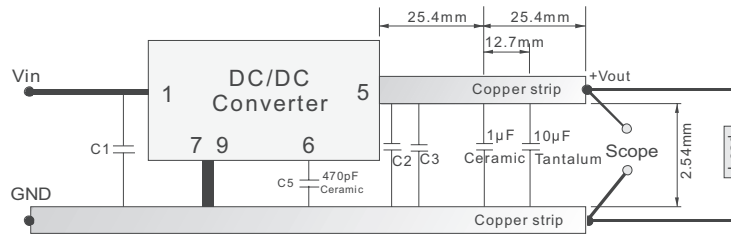

2) Start-up and Load Transient Response Test

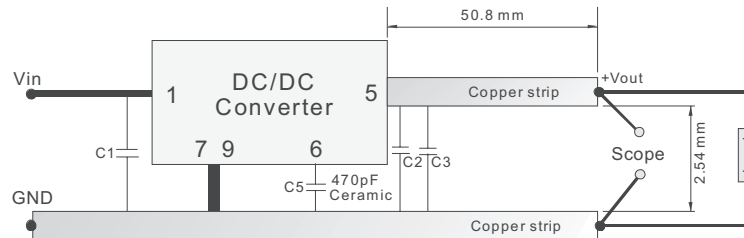

EFFICIENCY AND RIPPLE

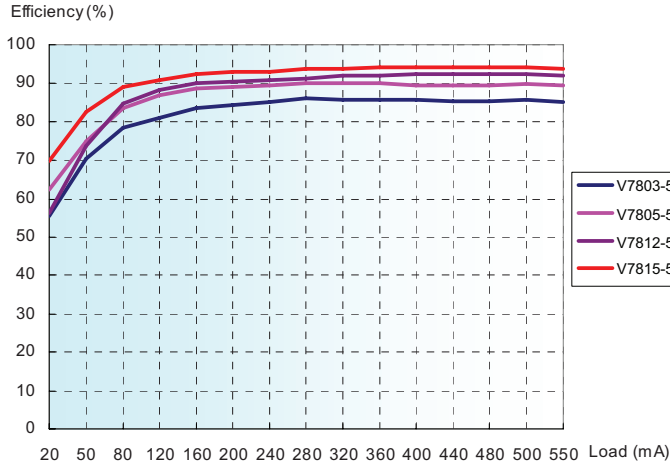

Efficiency VS Output Load (Vin=Norm)

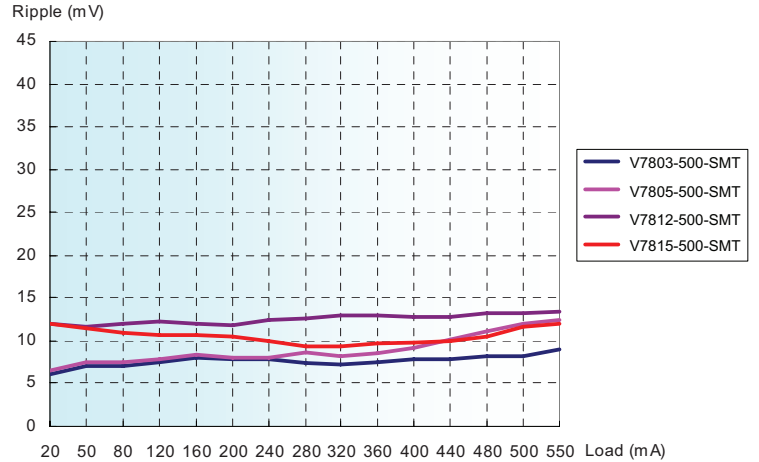

Output Voltage Ripple VS Output Load (Vin=Norm)

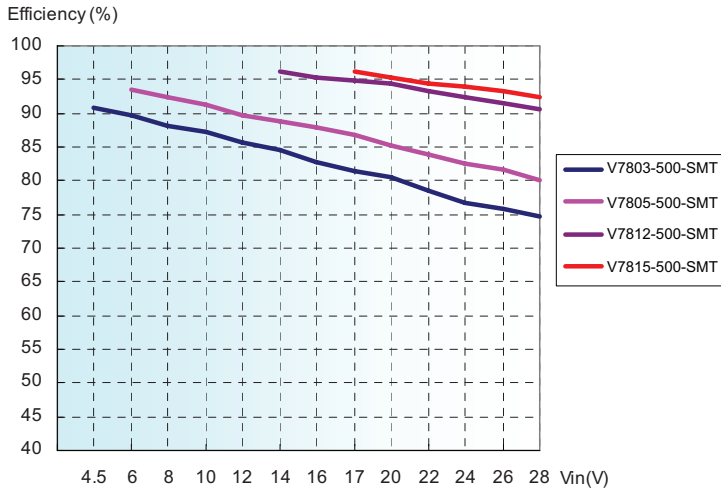

Efficiency VS Input Voltage (Full Load)

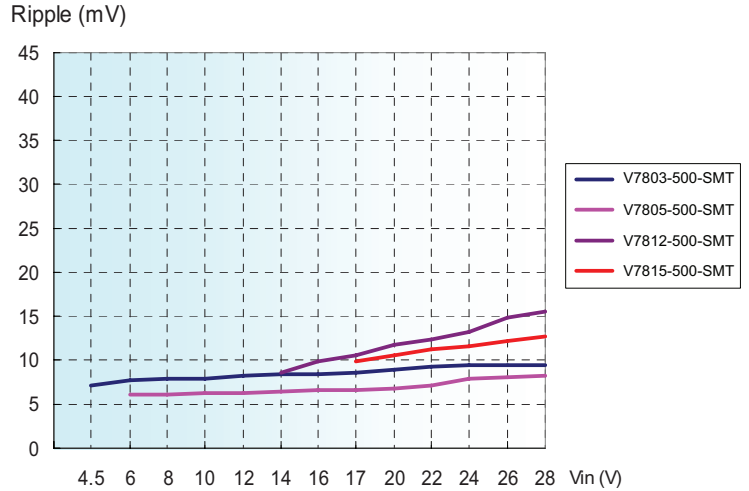

Output Voltage Ripple VS Input Voltage (Full Load)



Headquarters
 20050 SW 112th Ave.
 Tualatin, OR 97062
800.275.4899

Fax 503.612.2383
cui.com
 techsupport@cui.com

CUI offers a two (2) year limited warranty. Complete warranty information is listed on our website.

CUI reserves the right to make changes to the product at any time without notice. Information provided by CUI is believed to be accurate and reliable. However, no responsibility is assumed by CUI for its use, nor for any infringements of patents or other rights of third parties which may result from its use.

CUI products are not authorized or warranted for use as critical components in equipment that requires an extremely high level of reliability. A critical component is any component of a life support device or system whose failure to perform can be reasonably expected to cause the failure of the life support device or system, or to affect its safety or effectiveness.

SHUTDOWN CONTROL

The ON/OFF pin provides several features for adjusting and sequencing the power supply, a user has the flexibility of using the ON/OFF pin as:

- 1) A digital on/off control by pulling down the ON/OFF pin with an open-drain transistor.

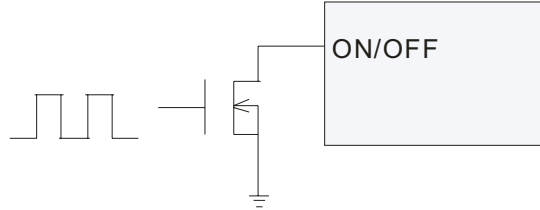

- 2) Line UVLO. If desired to achieve a UVLO voltage, a resistor divider from V_{in} to ON/OFF to GND can be used to disable the converter until a higher input voltage is achieved. For example, it is not useful for a converter with 12V output to start up with a 12V input, as the output cannot reach regulation. To enable the converter when the input voltage reaches 14V, a 51k Ω /5k Ω voltage divider from V_{in} to GND can be connected to the ON/OFF pin. Both the precision 1.25V threshold and 150mV hysteresis are multiplied by the resistor ratio, providing a proportional 12% hysteresis for any startup threshold. So, the turn off threshold would be between 12.3V to 15.7V.

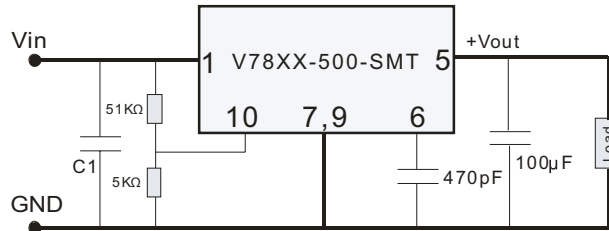

- 3) Power supply sequencing. By connecting a small capacitor from ON/OFF to GND, the 2 μ A current source and 1.25V threshold can provide a stable and predictable delay between startup of multiple power supplies. For example, a startup delay of roughly 64mS is provided using 100nF, and roughly 136mS by using 200nF.

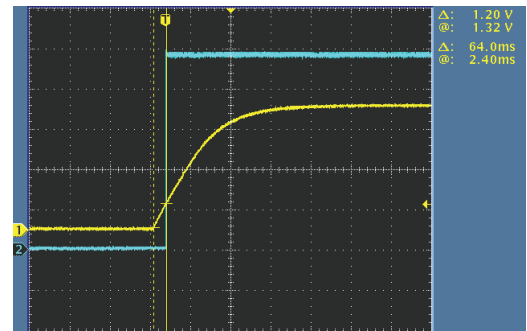
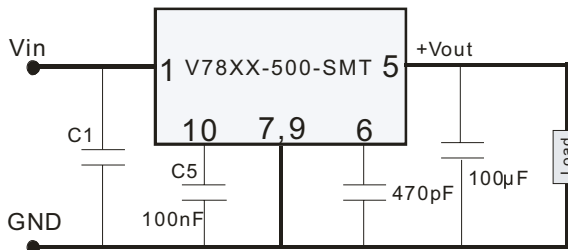

CH1: Von/off
CH2: Vo
Delay time: 64mS

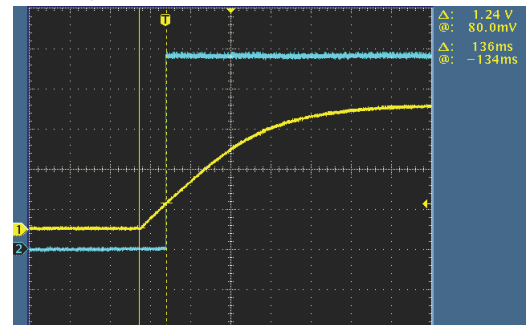
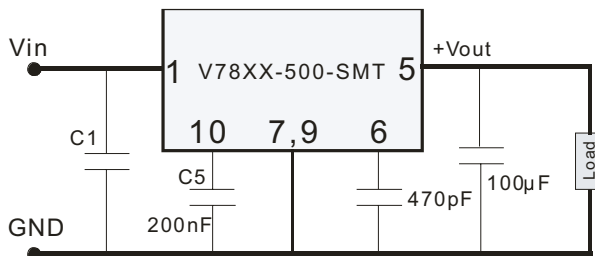

CH1: Von/off
CH2: Vo
Delay time: 136mS

REVISION HISTORY

rev.	description	date
1.0	initial release	01/04/2008
1.01	new template applied	04/28/2009
1.02	V-Infinity branding removed	09/06/2012
1.03	added TR package option	10/31/2012
1.04	added minimum loading requirement note	01/30/2013
1.05	updated spec	03/08/2013
1.06	housing width changed, updated datasheet	01/26/2016

The revision history provided is for informational purposes only and is believed to be accurate.

**CUI INC**[®]

Headquarters
20050 SW 112th Ave.
Tualatin, OR 97062
800.275.4899

Fax 503.612.2383
cui.com
techsupport@cui.com

CUI offers a two (2) year limited warranty. Complete warranty information is listed on our website.

CUI reserves the right to make changes to the product at any time without notice. Information provided by CUI is believed to be accurate and reliable. However, no responsibility is assumed by CUI for its use, nor for any infringements of patents or other rights of third parties which may result from its use.

CUI products are not authorized or warranted for use as critical components in equipment that requires an extremely high level of reliability. A critical component is any component of a life support device or system whose failure to perform can be reasonably expected to cause the failure of the life support device or system, or to affect its safety or effectiveness.