



Is Now Part of



ON Semiconductor®

To learn more about ON Semiconductor, please visit our website at
www.onsemi.com

Please note: As part of the Fairchild Semiconductor integration, some of the Fairchild orderable part numbers will need to change in order to meet ON Semiconductor's system requirements. Since the ON Semiconductor product management systems do not have the ability to manage part nomenclature that utilizes an underscore (_), the underscore (_) in the Fairchild part numbers will be changed to a dash (-). This document may contain device numbers with an underscore (_). Please check the ON Semiconductor website to verify the updated device numbers. The most current and up-to-date ordering information can be found at www.onsemi.com. Please email any questions regarding the system integration to Fairchild_questions@onsemi.com.

ON Semiconductor and the ON Semiconductor logo are trademarks of Semiconductor Components Industries, LLC dba ON Semiconductor or its subsidiaries in the United States and/or other countries. ON Semiconductor owns the rights to a number of patents, trademarks, copyrights, trade secrets, and other intellectual property. A listing of ON Semiconductor's product/patent coverage may be accessed at www.onsemi.com/site/pdf/Patent-Marking.pdf. ON Semiconductor reserves the right to make changes without further notice to any products herein. ON Semiconductor makes no warranty, representation or guarantee regarding the suitability of its products for any particular purpose, nor does ON Semiconductor assume any liability arising out of the application or use of any product or circuit, and specifically disclaims any and all liability, including without limitation special, consequential or incidental damages. Buyer is responsible for its products and applications using ON Semiconductor products, including compliance with all laws, regulations and safety requirements or standards, regardless of any support or applications information provided by ON Semiconductor. "Typical" parameters which may be provided in ON Semiconductor data sheets and/or specifications can and do vary in different applications and actual performance may vary over time. All operating parameters, including "Typicals" must be validated for each customer application by customer's technical experts. ON Semiconductor does not convey any license under its patent rights nor the rights of others. ON Semiconductor products are not designed, intended, or authorized for use as a critical component in life support systems or any FDA Class 3 medical devices or medical devices with a same or similar classification in a foreign jurisdiction or any devices intended for implantation in the human body. Should Buyer purchase or use ON Semiconductor products for any such unintended or unauthorized application, Buyer shall indemnify and hold ON Semiconductor and its officers, employees, subsidiaries, affiliates, and distributors harmless against all claims, costs, damages, and expenses, and reasonable attorney fees arising out of, directly or indirectly, any claim of personal injury or death associated with such unintended or unauthorized use, even if such claim alleges that ON Semiconductor was negligent regarding the design or manufacture of the part. ON Semiconductor is an Equal Opportunity/Affirmative Action Employer. This literature is subject to all applicable copyright laws and is not for resale in any manner.

FAN4174 / FAN4274

Single and Dual, Rail-to-Rail I/O, CMOS Amplifier

Features

- 200 μ A Supply Current per Amplifier
- 3.7 MHz Bandwidth
- Output Swing to Within 10 mV of Either Rail
- Input Voltage Range Exceeds the Rails
- 3 V / μ s Slew Rate
- 25 nV / $\sqrt{\text{Hz}}$ Input Voltage Noise
- Replaces KM4170 and KM4270
- FAN4174 Competes with OPA340 and TLV2461; Available in a SOT23-5 Package
- FAN4274 Competes with OPA2340 and TLV2462; Available in MSOP-8 Package
- Fully Specified at +5 V Supplies

Applications

- Motor Control
- Portable / Battery-powered Applications
- PCMCIA, USB
- Mobile Communications, Cellular Phones, Pagers
- Notebooks and PDAs
- Sensor Interface
- A/D Buffer
- Active Filters
- Signal Conditioning
- Portable Test Instruments

Description

The FAN4174 (single) and FAN4274 (dual) are voltage feedback amplifiers with CMOS inputs that consume only 200 μ A of supply current per amplifier, while providing ± 33 mA of output short-circuit current. These amplifiers are designed to operate 5 V supplies. The common mode voltage range extends beyond the negative and positive rails.

The FAN4174 and FAN4274 are designed on a CMOS process and provide 3.7 MHz of bandwidth and 3 V / μ s of slew rate at a supply voltage of 5 V.

These amplifiers operate and are reliable over a wide temperature range of -40°C to $+125^{\circ}\text{C}$.

The combination of extended temperature operation, low power, rail-to-rail performance, low-voltage operation, and a tiny package optimize this amplifier family for use in many industrial, general-purpose, and battery-powered applications.

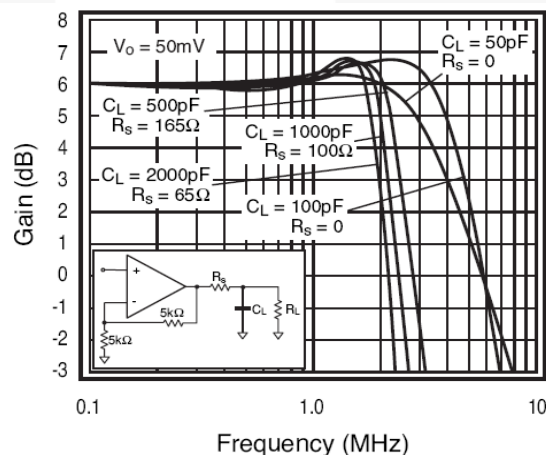

Figure 1. Frequency vs. Gain

Ordering Information

Part Number	Operating Temperature Range	Package	Packing Method
FAN4174IS5X	-40 to $+125^{\circ}\text{C}$	5-Lead SOT23 Package	Tape and Reel (3000)
FAN4274IMU8X	-40 to $+125^{\circ}\text{C}$	8-Lead Molded Small-Outline Package	Tape and Reel (3000)

Typical Application

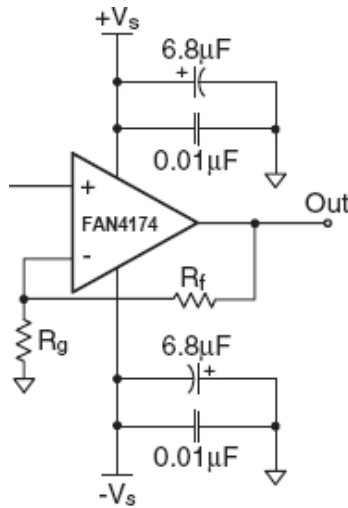

Figure 2. Typical Application Circuit

Pin Configurations

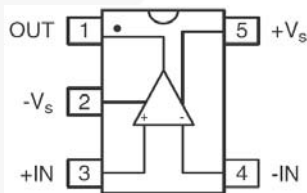

Figure 3. FAN4174 SOT23

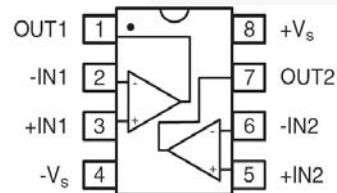

Figure 4. FAN4274 MSOP

FAN4174 Pin Assignments

Pin #	Name	Description
1	OUT	Output
2	-Vs	Negative Supply
3	+IN	Positive Supply
4	-IN	Negative Input
5	+Vs	Positive Supply

FAN4274 Pin Assignments

Pin #	Name	Description
1	OUT1	Output, Channel 1
2	-IN1	Negative Input, Channel 1
3	+IN1	Positive Input, Channel 1
4	-Vs	Negative Supply
5	+IN2	Positive Input, Channel 2
6	-IN2	Negative Input, Channel 2
7	OUT2	Output, Channel 2
8	+Vs	Positive Supply

Absolute Maximum Ratings

Stresses exceeding the absolute maximum ratings may damage the device. The device may not function or be operable above the recommended operating conditions and stressing the parts to these levels is not recommended. In addition, extended exposure to stresses above the recommended operating conditions may affect device reliability. The absolute maximum ratings are stress ratings only. Functional operation under any of these conditions is NOT implied. Performance and reliability are guaranteed only if operating conditions are not exceeded.

Symbol	Parameter	Min.	Max.	Unit
V_{CC}	Supply Voltage	0	6	V
V_{IN}	Input Voltage Range	$-V_S-0.5$	$+V_S+0.5$	V
T_J	Junction Temperature		+150	°C
T_{STG}	Storage Temperature	-65	+150	°C
T_L	Lead Soldering, 10 Seconds		+300	°C
Θ_{JA}	Thermal Resistance ⁽¹⁾	5-Lead SOT23	256	°C/W
		8-Lead MSOP	206	

Note:

1. Package thermal resistance JEDEC standard, multi-layer test boards, still air.

Recommended Operating Conditions

The Recommended Operating Conditions table defines the conditions for actual device operation. Recommended operating conditions are specified to ensure optimal performance to the datasheet specifications. Fairchild does not recommend exceeding them or designing to Absolute Maximum Ratings.

Symbol	Parameter	Min.	Max.	Unit
$+V_S$	Supply Voltage	2.30	5.25	V
T_A	Operating Temperature Range	-40	+125	°C

Electrical Specifications at +2.7 V

$V_S=+2.7\text{ V}$, $G=2$, $R_L=10\text{ k}\Omega$ to $V_S/2$, $R_F=5\text{ k}\Omega$; unless otherwise noted.

Symbol	Parameter	Conditions	Min.	Typ.	Max.	Units
Frequency Domain Response						
UGBW	-3 dB Bandwidth	$G=+1$		4.0		MHz
BW_{SS}					2.5	
GBWP	Gain Bandwidth Product			4		MHz
Time Domain Response						
t_R, t_F	Rise and Fall Time	$V_O=1.0\text{ V Step}$		300		ns
OS	Overshoot	$V_O=1.0\text{ V Step}$		5		%
SR	Slew Rate	$V_O=3\text{ V Step, } G=-1$		3		V/ μ s
Distortion and Noise Response						
HD2	2nd Harmonic Distortion	$V_O=1\text{ V}_{PP}, 10\text{ kHz}$		-66		dBc
HD3	3rd Harmonic Distortion	$V_O=1\text{ V}_{PP}, 10\text{ kHz}$		-67		dBc
THD	Total Harmonic Distortion	$V_O=1\text{ V}_{PP}, 10\text{ kHz}$		0.1		%
e_n	Input Voltage Noise			26		nV/ $\sqrt{\text{Hz}}$
X_{TALK}	Crosstalk (FAN4274)	100 kHz		-100		dB
DC Performance						
V_{IO}	Input Offset Voltage ⁽²⁾		-6	0	+6	mV
dV_{IO}	Average Drift			2.1		$\mu\text{V}/^\circ\text{C}$
I_{bn}	Input Bias Current			5		pA
PSRR	Power Supply Rejection Ratio ⁽²⁾	DC	50	73		dB
A_{OL}	Open-loop Gain	DC		98		dB
I_S	Supply Current per Amplifier ⁽²⁾			200	300	μA
Input Characteristics						
R_{IN}	Input Resistance			10		$\text{G}\Omega$
C_{IN}	Input Capacitance			1.4		pF
CMIR	Input Common Mode Voltage Range			-0.3 to 2.8		V
CMRR	Common Mode Rejection Ratio ⁽²⁾	FAN4174	DC, $V_{CM}=0\text{ V to }2.2\text{ V}$	50	65	dB
		FAN4274	DC, $V_{CM}=0\text{ V to }2.2\text{ V}$	50	65	
Output Characteristics						
V_O	Output Voltage Swing ⁽²⁾	$R_L=10\text{ k}\Omega$ to $V_S/2$	0.03	0.01 to 2.69	2.65	V
		$R_L=1\text{ k}\Omega$ to $V_S/2$		0.05 to 2.55		
I_{SC}	Short-Circuit Output Current			+34/-12		mA
V_S	Power Supply Operating Range			2.5 to 5.5		V

Note:

2. 100% tested at 25°C.

Electrical Specifications at +5 V

$V_S=+5\text{ V}$, $G=2$, $R_L=10\text{ k}\Omega$ to $V_S/2$, $R_F=5\text{ k}\Omega$; unless otherwise noted.

Symbol	Parameter	Conditions	Min.	Typ.	Max.	Units
Frequency Domain Response						
UGBW	-3dB Bandwidth	$G=+1$, $T_A=85^\circ\text{C}$		3.7		MHz
		$G=+1$, $T_A=125^\circ\text{C}$		3.2		
BW _{SS}				2.3		MHz
GBWP	Gain Bandwidth Product	$T_A=85^\circ\text{C}$		3.7		MHz
		$T_A=125^\circ\text{C}$		3.2		
Time Domain Response						
t_R , f_F	Rise and Fall Time	$V_O=1.0\text{ V Step}$		300		ns
OS	Overshoot	$V_O=1.0\text{ V Step}$		5		%
SR	Slew Rate	$V_O=3\text{ V Step}$, $G=-1$		3		V/ μs
Distortion and Noise Response						
HD2	2nd Harmonic Distortion	$V_O=1\text{ V}_{PP}$, 10 kHz		-80		dBc
HD3	3rd Harmonic Distortion	$V_O=1\text{ V}_{PP}$, 10 kHz		-80		dBc
THD	Total Harmonic Distortion	$V_O=1\text{ V}_{PP}$, 10 kHz		0.02		%
e_n	Input Voltage Noise			25		nV/ $\sqrt{\text{Hz}}$
X _{TALK}	Crosstalk (FAN4274)	100 kHz		-100		dB
DC Performance						
V_{IO}	Input Offset Voltage ⁽³⁾		-8	0	+8	mV
dV_{IO}	Average Drift			2.9		$\mu\text{V}/^\circ\text{C}$
I_{bn}	Input Bias Current			5		pA
PSRR	Power Supply Rejection Ratio ⁽³⁾	DC	50	73		dB
A _{OL}	Open-loop Gain	DC		102		dB
I_S	Supply Current per Amplifier ⁽³⁾			200	300	μA
Input Characteristics						
R_{IN}	Input Resistance			10		G Ω
C_{IN}	Input Capacitance			1.2		pF
CMIR	Input Common Mode Voltage Range			-0.3 to 5.1		V
CMRR	Common Mode Rejection Ratio ⁽³⁾	DC, $V_{CM}=0\text{ V to }V_S$	58	73		dB
Output Characteristics						
V_O	Output Voltage Swing ⁽³⁾	$R_L=10\text{ k}\Omega$ to $V_S/2$	0.03	0.01 to 4.99	4.95	V
		$R_L=1\text{ k}\Omega$ to $V_S/2$		0.1 to 4.9		
I_{SC}	Short-Circuit Output Current			± 33		mA
V_S	Power Supply Operating Range			2.5 to 5.5		V

Note:

3. 100% tested at 25°C.

Typical Performance Characteristics

$V_S = +2.7\text{ V}$, $G = 2$, $R_L = 10\text{ k}\Omega$ to $V_S/2$, $R_F = 5\text{ k}\Omega$; unless otherwise noted.

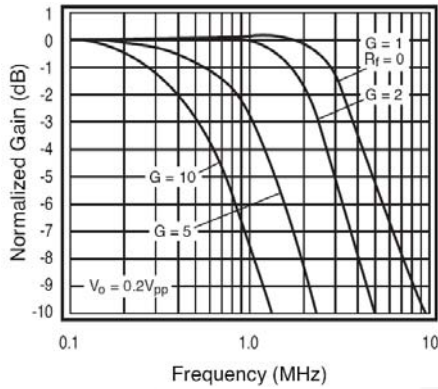

Figure 5. Non-Inverting Frequency Response (+5 V)

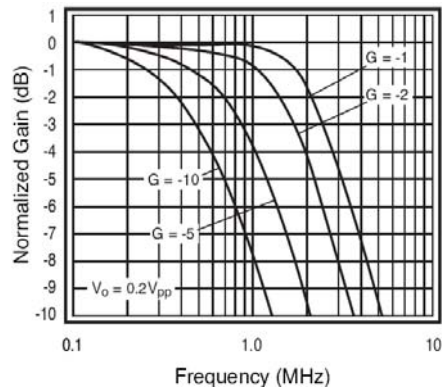

Figure 6. Inverting Frequency Response (+5 V)

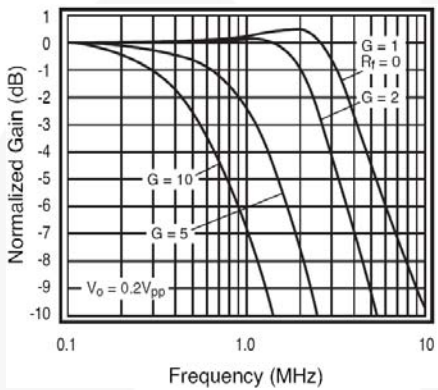

Figure 7. Non-Inverting Frequency Response

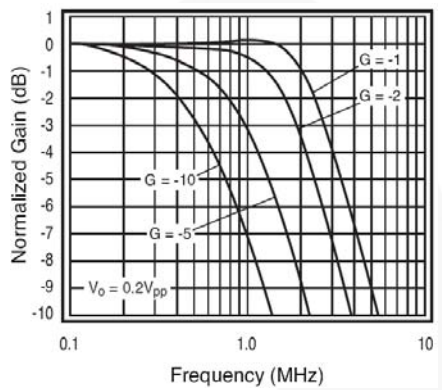

Figure 8. Inverting Frequency Response

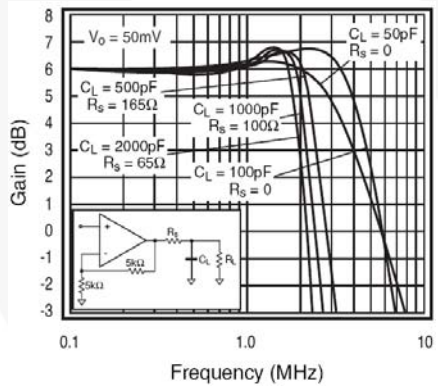

Figure 9. Frequency Response vs. C_L

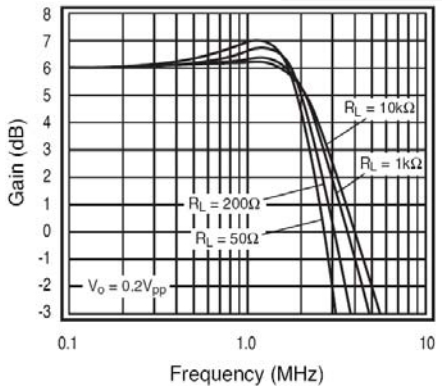

Figure 10. Frequency Response vs. R_L

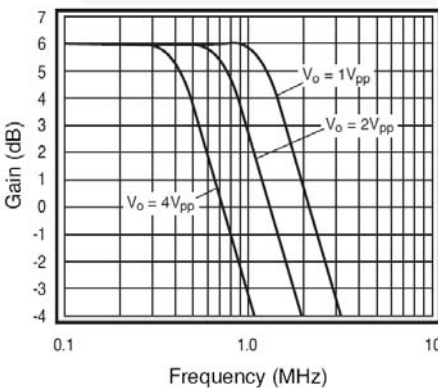

Figure 11. Large Signal Frequency Response (+5 V)

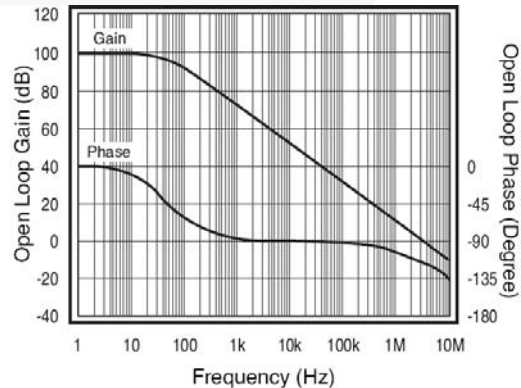

Figure 12. Open-loop Gain and Phase vs. Frequency

Typical Performance Characteristic

$V_S = +2.7\text{ V}$, $G=2$, $R_L = 10\text{ k}\Omega$ to $V_S/2$, $R_F = 5\text{ k}\Omega$; unless otherwise noted.

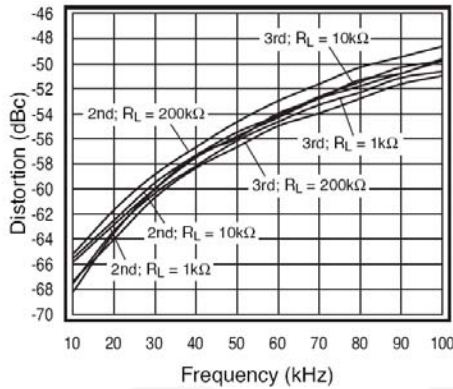

Figure 13. 2nd and 3rd Harmonic Distortion

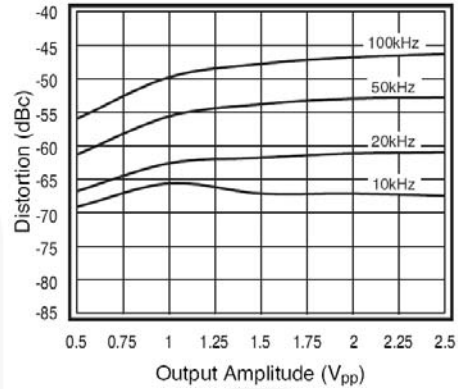

Figure 14. 2nd Harmonic Distortion vs. V_O

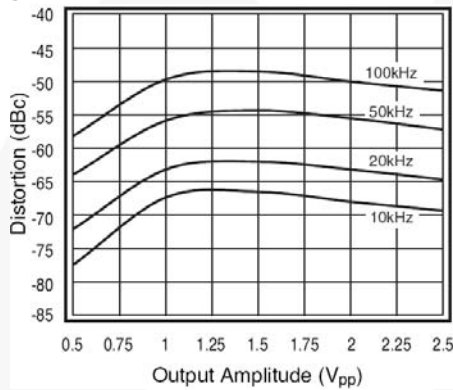

Figure 15. 3rd Harmonic Distortion vs. V_O

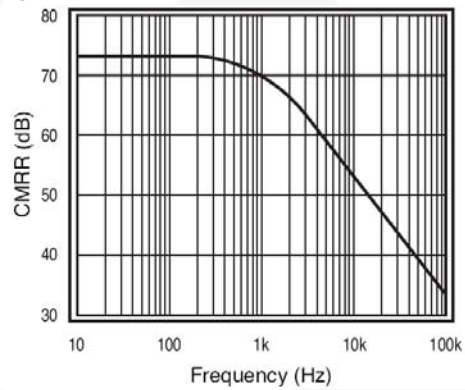

Figure 16. CMRR $V_S = 5\text{ V}$

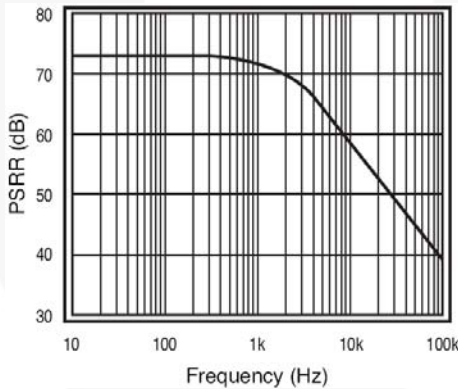

Figure 17. PSRR $V_S = 5\text{ V}$

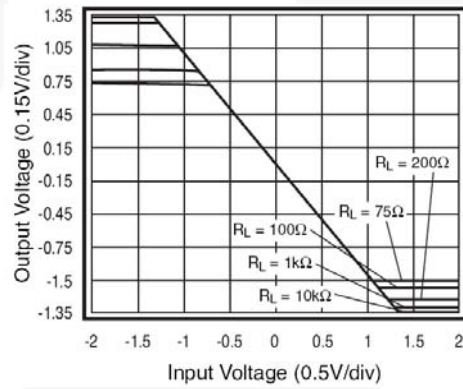

Figure 18. Output Swing vs. Load

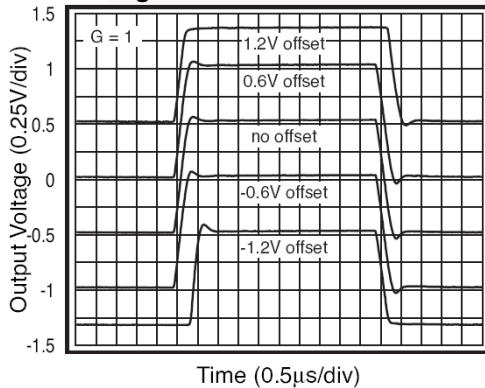

Figure 19. Pulse Response vs. Common-Mode Voltage

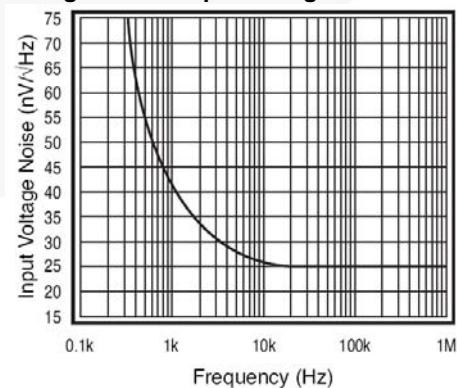

Figure 20. Input Voltage Noise

Application Information

General Description

The FAN4174 amplifier includes single-supply, general-purpose, voltage-feedback amplifiers, fabricated on a bi-CMOS process. The family features a rail-to-rail input and output and is unity gain stable. The typical non-inverting circuit schematic is shown in Figure 21.

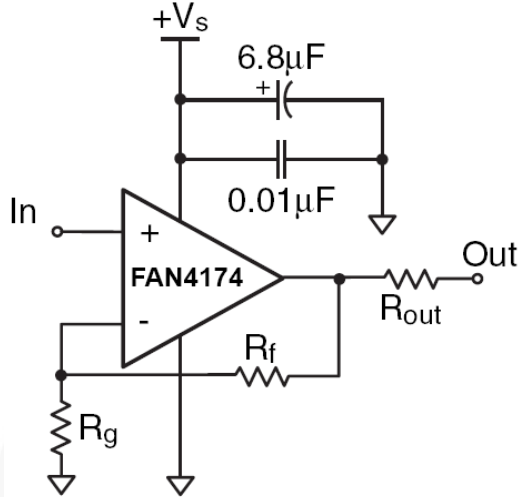

Figure 21. Typical Non-inverting Configuration

Input Common Mode Voltage

The common mode input range extends to 300 mV below ground and to 100 mV above V_S in single supply operation. Exceeding these values does not cause phase reversal; however, if the input voltage exceeds the rails by more than 0.5 V, the input ESD devices begin to conduct. The output stays at the rail during this overdrive condition. If the absolute maximum input V_{IN} (700 mV beyond either rail) is exceeded, externally limit the input current to ± 5 mA, as shown in Figure 22.

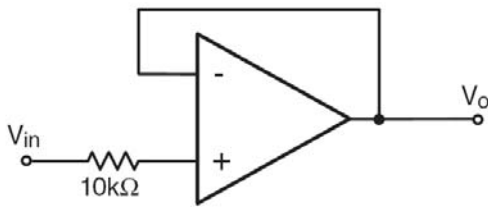

Figure 22. Circuit for Input Current Protection

Power Dissipation

The maximum internal power dissipation allowed is directly related to the maximum junction temperature. If the maximum junction temperature exceeds 150°C, performance degradation occurs. If the maximum junction temperature exceeds 150°C for an extended time, device failure may occur.

Overdrive Recovery

Overdrive of an amplifier occurs when the output and/or input ranges are exceeded. The recovery time varies based on whether the input or output is overdriven and by how much the range is exceeded. The FAN4174 typically recovers in less than 500 ns from an overdrive condition. Figure 23 shows the FAN4174 amplifier in an overdriven condition.

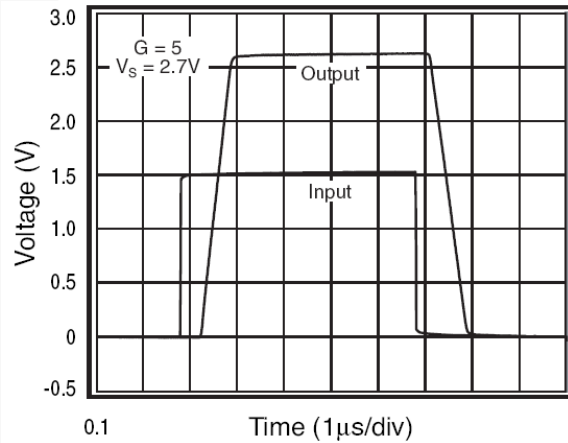

Figure 23. Overdrive Recovery

Driving Capacitive Loads

Figure 9 illustrates the response of the FAN4174 amplifier. A small series resistance (R_S) at the output of the amplifier, illustrated in Figure 24, improves stability and settling performance. R_S values in Figure 9 achieve maximum bandwidth with less than 2 dB of peaking. For maximum flatness, use a larger R_S . Capacitive loads larger than 500 pF require the use of R_S .

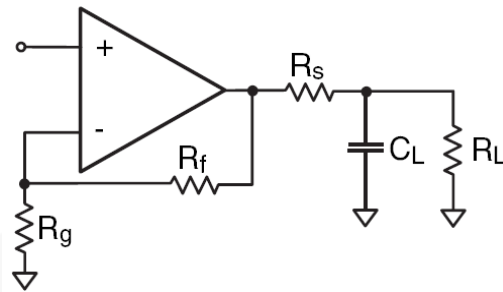

Figure 24. Typical Topology for Driving a Capacitive Load

Driving a capacitive load introduces phase-lag into the output signal, which reduces phase margin in the amplifier. The unity gain follower is the most sensitive configuration. In a unity gain follower configuration, the FAN4174 amplifier requires a 300 Ω series resistor to drive a 100 pF load.

Layout Considerations

General layout and supply bypassing play major roles in high-frequency performance. Fairchild evaluation boards help guide high-frequency layout and aid in device testing and characterization. Follow the steps below as a basis for high-frequency layout:

1. Include 6.8 μF and 0.01 μF ceramic capacitors.
2. Place the 6.8 μF capacitor within 19.05 mm (0.75 inches) of the power pin.
3. Place the 0.01 μF capacitor within 2.54 mm (0.1 inches) of the power pin.
4. Remove the ground plane under and around the part, especially near the input and output pins, to reduce parasitic capacitance.

Minimize all trace lengths to reduce series inductances.

Refer to the evaluation board layouts shown in Figure 27 through Figure 30 for more information.

When evaluating only one channel, complete the following on the unused channel:

1. Ground the non-inverting input.
2. Short the output to the inverting input.

Evaluation Board Information

The following evaluation boards are available to aid in the testing and layout of this device:

Board	Description	Product
KEB002	Single Channel, Dual Supply, 5 and 6-Lead SOT23	FAN4174IS5X
KEB010	Dual Channel, Dual Supply 8-Lead MSOP	FAN4274IMU8X

Evaluation board schematics are shown in Figure 25 and Figure 26; layouts are shown in Figure 27 through Figure 30.

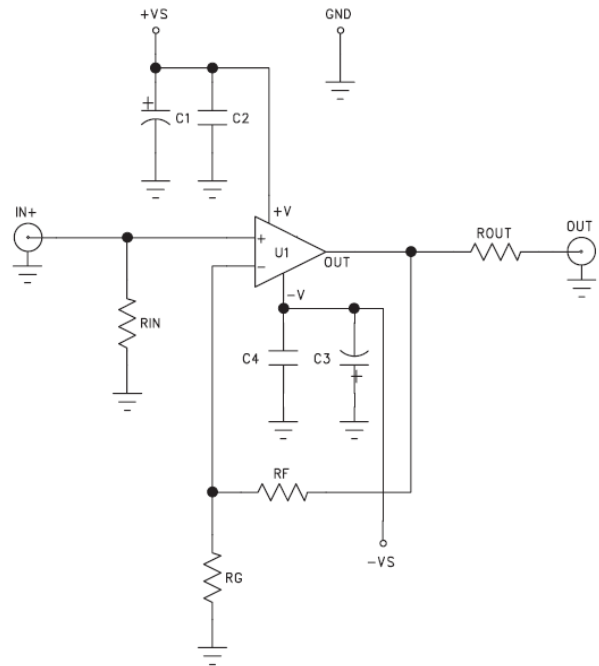

Figure 25. FAN4174 Evaluation Board Schematic (KEV002)

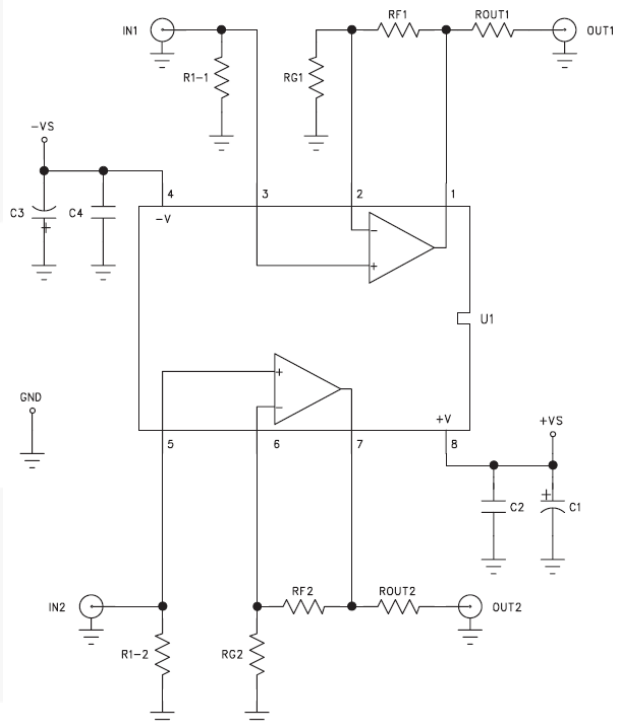

Figure 26. FAN4274 Evaluation Board Schematic (KEB010)

Board Layout Information

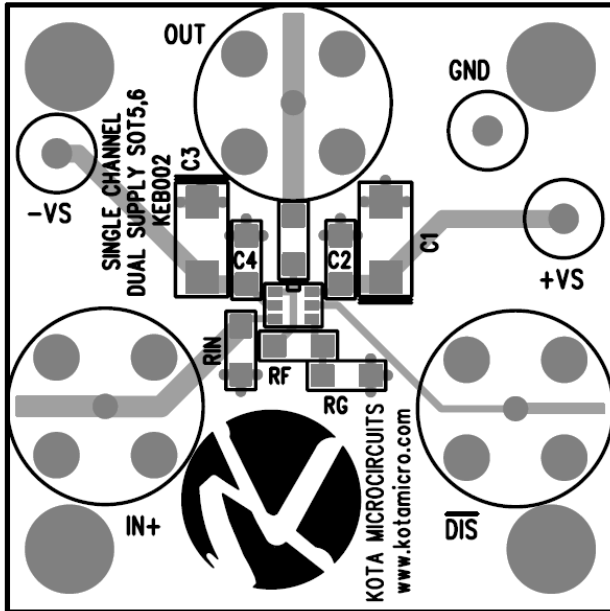

Figure 27. KEB002 (Top Side)

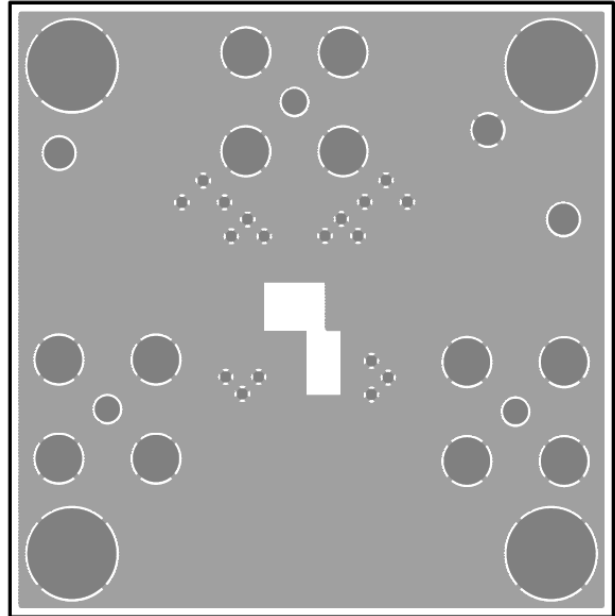

Figure 28. KEB002 (Bottom Side)

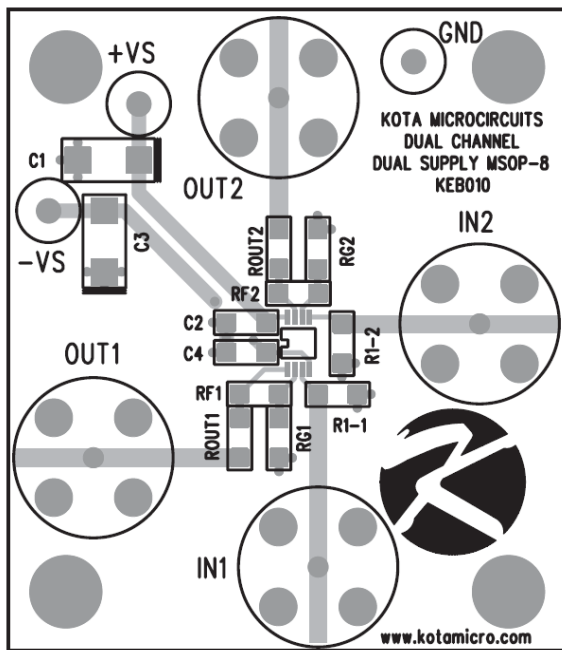

Figure 29. KEB010 (Top Side)

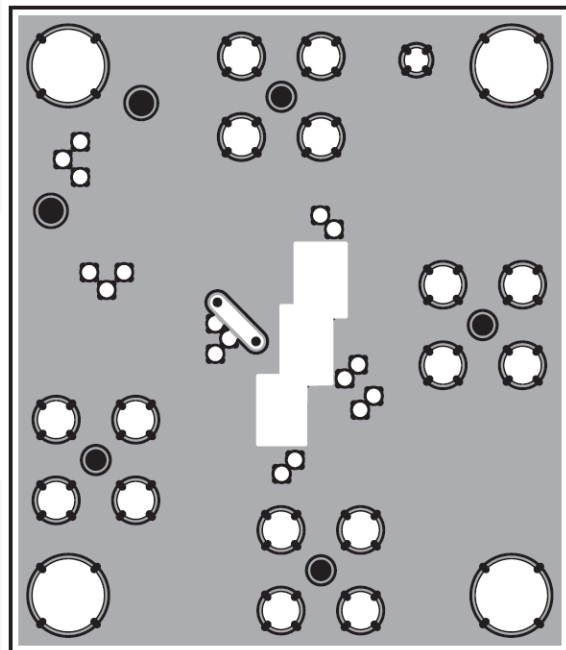

Figure 30. KEB010 (Bottom Side)

Physical Dimensions

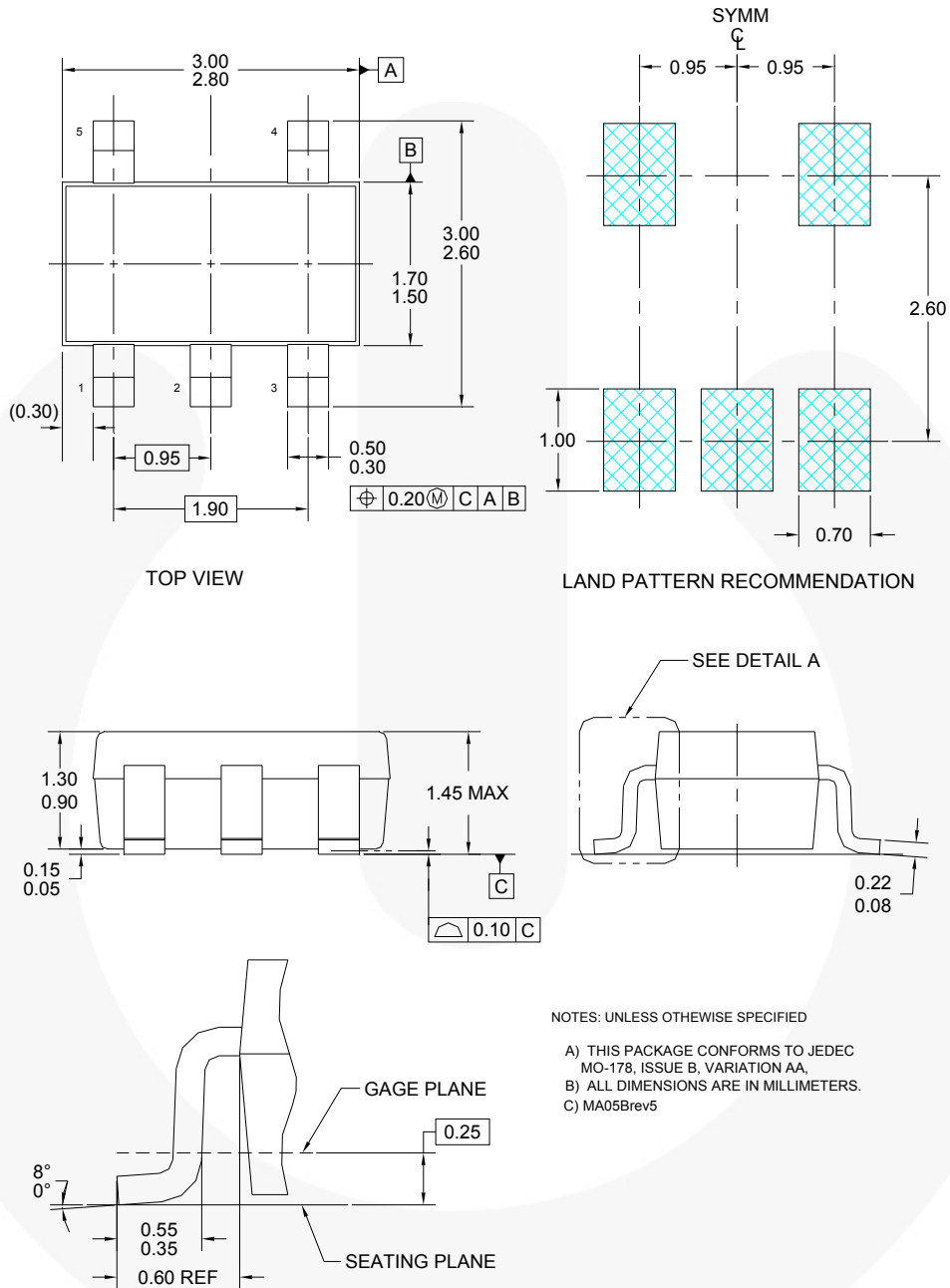

Figure 31. 5-Lead SOT-23 Package

Package drawings are provided as a service to customers considering Fairchild components. Drawings may change in any manner without notice. Please note the revision and/or date on the drawing and contact a Fairchild Semiconductor representative to verify or obtain the most recent revision. Package specifications do not expand the terms of Fairchild's worldwide terms and conditions, specifically the warranty therein, which covers Fairchild products.

Always visit Fairchild Semiconductor's online packaging area for the most recent package drawings:
<http://www.fairchildsemi.com/packaging/>.

Physical Dimensions

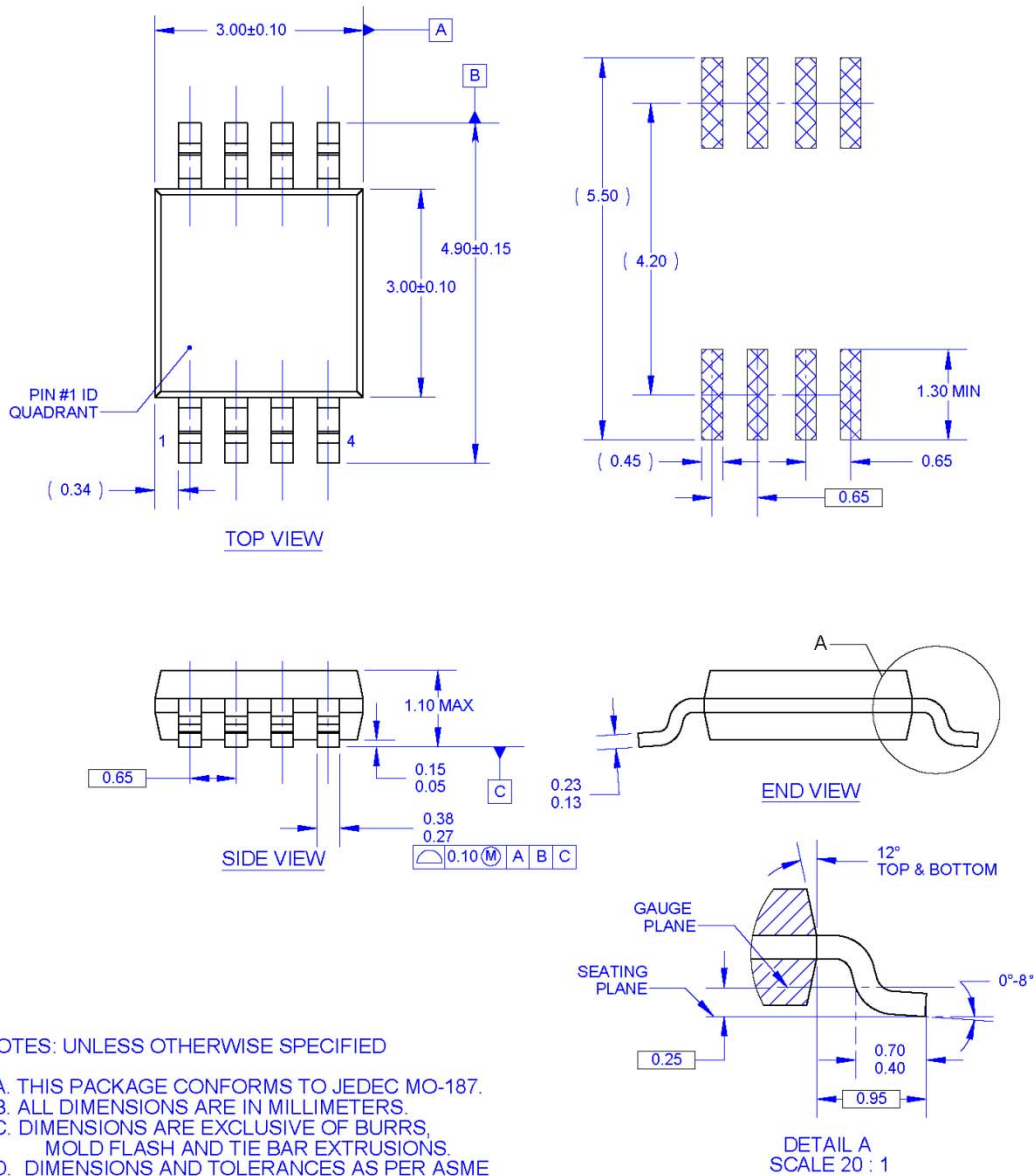







Figure 32. 8-Lead Molded Small Outline Package (MSOP)

Package drawings are provided as a service to customers considering Fairchild components. Drawings may change in any manner without notice. Please note the revision and/or date on the drawing and contact a Fairchild Semiconductor representative to verify or obtain the most recent revision. Package specifications do not expand the terms of Fairchild's worldwide terms and conditions, specifically the warranty therein, which covers Fairchild products.

Always visit Fairchild Semiconductor's online packaging area for the most recent package drawings:
<http://www.fairchildsemi.com/packaging/>.

TRADEMARKS

The following includes registered and unregistered trademarks and service marks, owned by Fairchild Semiconductor and/or its global subsidiaries, and is not intended to be an exhaustive list of all such trademarks.

2Cool™	FPS™		Sync-Lock™
AccuPower™	F-PFS™	PowerTrench®	 SYSTEM GENERAL®
AX-CAP®*	FRFET®	PowerXS™	TinyBoost™
BitSiC™	Global Power Resource™	Programmable Active Droop™	TinyBuck™
Build it Now™	GreenBridge™	QFET®	TinyCalc™
CorePLUS™	Green FPS™	QS™	TinyLogic®
CorePOWER™	Green FPS™ e-Series™	Quiet Series™	TINYOPTO™
CROSSVOLT™	Gmax™	RapidConfigure™	TinyPower™
CTL™	GTO™		TinyPWM™
Current Transfer Logic™	IntelliMAX™	Saving our world, 1mW/W/kW at a time™	TinyWire™
DEUXPEED®	ISOPLANAR™	SignalWise™	TransiC™
Dual Cool™	Making Small Speakers Sound Louder and Better™	SmartMax™	TriFault Detect™
EcoSPARK®	MegaBuck™	SMART START™	TRUECURRENT®*
EfficientMax™	MICROCOUPLER™	Solutions for Your Success™	µSerDes™
ESBC™	MicroFET™	SPM®	 SerDes®
	MicroPak™	STEALTH™	UHC®
Fairchild®	MicroPak2™	SuperFET®	Ultra FRFET™
Fairchild Semiconductor®	MillerDrive™	SuperSOT™-3	UniFET™
FACT Quiet Series™	MotionMax™	SuperSOT™-6	VCX™
FACT®	mWSaver™	SuperSOT™-8	VisualMax™
FAST®	OptoHiT™	SupreMOS®	VoltagePlus™
FastvCore™	OPTOLOGIC®	SyncFET™	XS™
FETBench™	OPTOPLANAR®		

* Trademarks of System General Corporation, used under license by Fairchild Semiconductor.

DISCLAIMER

FAIRCHILD SEMICONDUCTOR RESERVES THE RIGHT TO MAKE CHANGES WITHOUT FURTHER NOTICE TO ANY PRODUCTS HEREIN TO IMPROVE RELIABILITY, FUNCTION, OR DESIGN. FAIRCHILD DOES NOT ASSUME ANY LIABILITY ARISING OUT OF THE APPLICATION OR USE OF ANY PRODUCT OR CIRCUIT DESCRIBED HEREIN; NEITHER DOES IT CONVEY ANY LICENSE UNDER ITS PATENT RIGHTS, NOR THE RIGHTS OF OTHERS. THESE SPECIFICATIONS DO NOT EXPAND THE TERMS OF FAIRCHILD'S WORLDWIDE TERMS AND CONDITIONS, SPECIFICALLY THE WARRANTY THEREIN, WHICH COVERS THESE PRODUCTS.

LIFE SUPPORT POLICY

FAIRCHILD'S PRODUCTS ARE NOT AUTHORIZED FOR USE AS CRITICAL COMPONENTS IN LIFE SUPPORT DEVICES OR SYSTEMS WITHOUT THE EXPRESS WRITTEN APPROVAL OF FAIRCHILD SEMICONDUCTOR CORPORATION.

As used herein:

- Life support devices or systems are devices or systems which, (a) are intended for surgical implant into the body or (b) support or sustain life, and (c) whose failure to perform when properly used in accordance with instructions for use provided in the labeling, can be reasonably expected to result in a significant injury of the user.
- A critical component in any component of a life support, device, or system whose failure to perform can be reasonably expected to cause the failure of the life support device or system, or to affect its safety or effectiveness.

ANTI-COUNTERFEITING POLICY

Fairchild Semiconductor Corporation's Anti-Counterfeiting Policy. Fairchild's Anti-Counterfeiting Policy is also stated on our external website, www.fairchildsemi.com, under Sales Support.

Counterfeiting of semiconductor parts is a growing problem in the industry. All manufacturers of semiconductor products are experiencing counterfeiting of their parts. Customers who inadvertently purchase counterfeit parts experience many problems such as loss of brand reputation, substandard performance, failed applications, and increased cost of production and manufacturing delays. Fairchild is taking strong measures to protect ourselves and our customers from the proliferation of counterfeit parts. Fairchild strongly encourages customers to purchase Fairchild parts either directly from Fairchild or from Authorized Fairchild Distributors who are listed by country on our web page cited above. Products customers buy either from Fairchild directly or from Authorized Fairchild Distributors are genuine parts, have full traceability, meet Fairchild's quality standards for handling and storage and provide access to Fairchild's full range of up-to-date technical and product information. Fairchild and our Authorized Distributors will stand behind all warranties and will appropriately address any warranty issues that may arise. Fairchild will not provide any warranty coverage or other assistance for parts bought from Unauthorized Sources. Fairchild is committed to combat this global problem and encourage our customers to do their part in stopping this practice by buying direct or from authorized distributors.

PRODUCT STATUS DEFINITIONS
Definition of Terms

Datasheet Identification	Product Status	Definition
Advance Information	Formative / In Design	Datasheet contains the design specifications for product development. Specifications may change in any manner without notice.
Preliminary	First Production	Datasheet contains preliminary data; supplementary data will be published at a later date. Fairchild Semiconductor reserves the right to make changes at any time without notice to improve design.
No Identification Needed	Full Production	Datasheet contains final specifications. Fairchild Semiconductor reserves the right to make changes at any time without notice to improve the design.
Obsolete	Not In Production	Datasheet contains specifications on a product that is discontinued by Fairchild Semiconductor. The datasheet is for reference information only.

Rev. 164

ON Semiconductor and  are trademarks of Semiconductor Components Industries, LLC dba ON Semiconductor or its subsidiaries in the United States and/or other countries. ON Semiconductor owns the rights to a number of patents, trademarks, copyrights, trade secrets, and other intellectual property. A listing of ON Semiconductor's product/patent coverage may be accessed at www.onsemi.com/site/pdf/Patent-Marking.pdf. ON Semiconductor reserves the right to make changes without further notice to any products herein. ON Semiconductor makes no warranty, representation or guarantee regarding the suitability of its products for any particular purpose, nor does ON Semiconductor assume any liability arising out of the application or use of any product or circuit, and specifically disclaims any and all liability, including without limitation special, consequential or incidental damages. Buyer is responsible for its products and applications using ON Semiconductor products, including compliance with all laws, regulations and safety requirements or standards, regardless of any support or applications information provided by ON Semiconductor. "Typical" parameters which may be provided in ON Semiconductor data sheets and/or specifications can and do vary in different applications and actual performance may vary over time. All operating parameters, including "Typicals" must be validated for each customer application by customer's technical experts. ON Semiconductor does not convey any license under its patent rights nor the rights of others. ON Semiconductor products are not designed, intended, or authorized for use as a critical component in life support systems or any FDA Class 3 medical devices or medical devices with a same or similar classification in a foreign jurisdiction or any devices intended for implantation in the human body. Should Buyer purchase or use ON Semiconductor products for any such unintended or unauthorized application, Buyer shall indemnify and hold ON Semiconductor and its officers, employees, subsidiaries, affiliates, and distributors harmless against all claims, costs, damages, and expenses, and reasonable attorney fees arising out of, directly or indirectly, any claim of personal injury or death associated with such unintended or unauthorized use, even if such claim alleges that ON Semiconductor was negligent regarding the design or manufacture of the part. ON Semiconductor is an Equal Opportunity/Affirmative Action Employer. This literature is subject to all applicable copyright laws and is not for resale in any manner.

PUBLICATION ORDERING INFORMATION

LITERATURE FULFILLMENT:

Literature Distribution Center for ON Semiconductor
19521 E. 32nd Pkwy, Aurora, Colorado 80011 USA
Phone: 303-675-2175 or 800-344-3860 Toll Free USA/Canada
Fax: 303-675-2176 or 800-344-3867 Toll Free USA/Canada
Email: orderlit@onsemi.com

N. American Technical Support: 800-282-9855 Toll Free
USA/Canada
Europe, Middle East and Africa Technical Support:
Phone: 421 33 790 2910
Japan Customer Focus Center
Phone: 81-3-5817-1050

ON Semiconductor Website: www.onsemi.com
Order Literature: <http://www.onsemi.com/orderlit>
For additional information, please contact your local
Sales Representative

Mouser Electronics

Authorized Distributor

Click to View Pricing, Inventory, Delivery & Lifecycle Information:

[ON Semiconductor:](#)

[FAN4174IS5X](#) [FAN4174IP5X](#)