

# MLC Capacitors



# Introduction to Knowles Capacitors

At Knowles Capacitors we make Single Layer, Multilayer, High Reliability and Precision Variable Capacitors; EMI Filters and Thin Film Devices.

Our business was formed by combining Dielectric Laboratories, Johanson Manufacturing, Novacap, Syfer Technology and Voltronics into a single organization - each well-established specialty capacitor makers with a combined history of over 175 years.

Our expertise is the design and manufacture of components important to engineers in applications where function and reliability are key. The markets we serve include medical implantable and medical equipment, military, aerospace/ avionics, EMI and connector filtering, oil exploration, instrumentation, industrial electronics, optical networks, telecom and automotive.

**We aim to be a leader in every market we serve, to the benefit of our customers and our mutual long-term success. We achieve this by:**

- Understanding our customers' real needs and providing products and services to meet and exceed them.
- Providing better products and services than competitors.
- Investing in product development, manufacturing processes and people.
- Insisting on the highest ethical standards and a business culture of trust, respect and open communication.

Products in this catalogue form the basis of our ranges for 'new designs'. However, there are legacy products from our five brands that will still be available – we ask that you contact your local Sales Office for details and ordering.



DLI•JohansonMFG•Novacap•Syfer•Voltronics

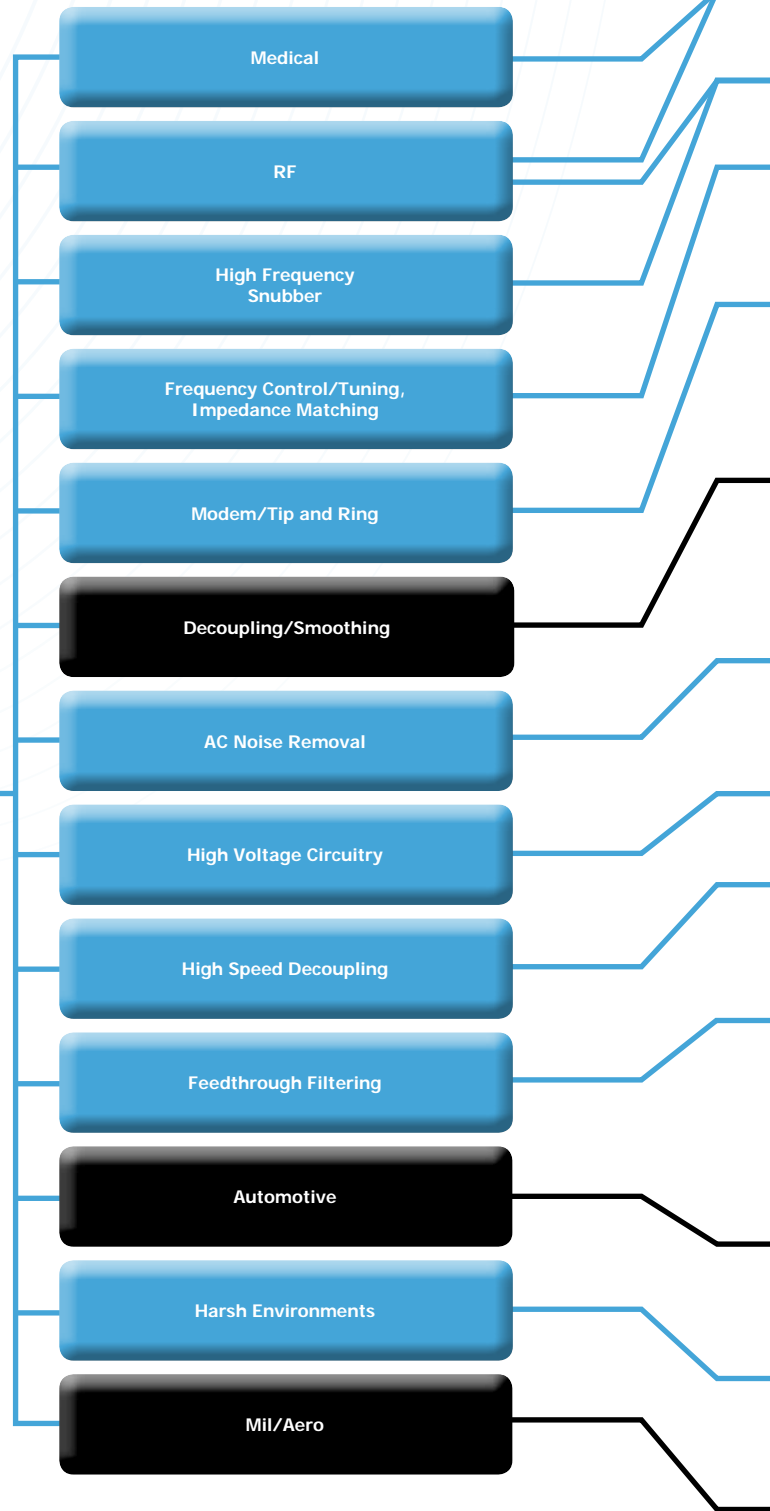
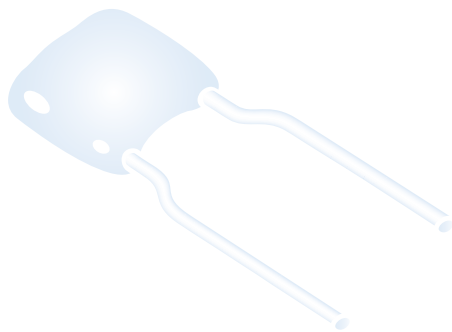
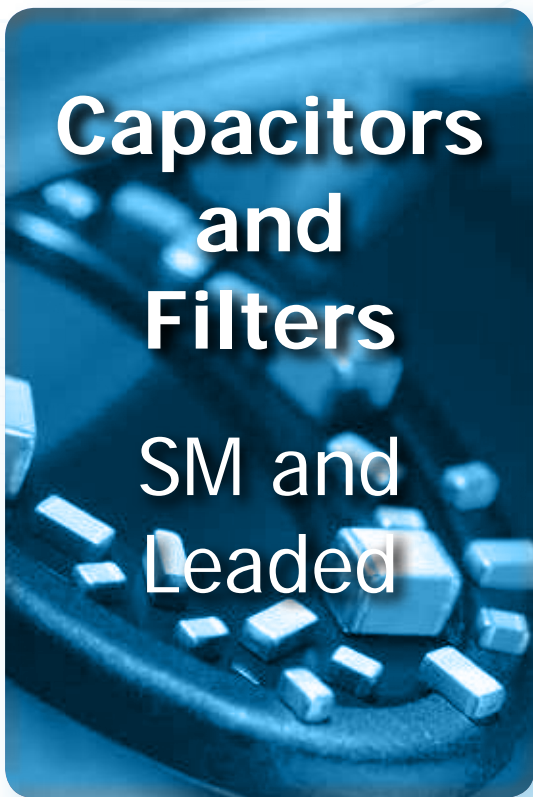

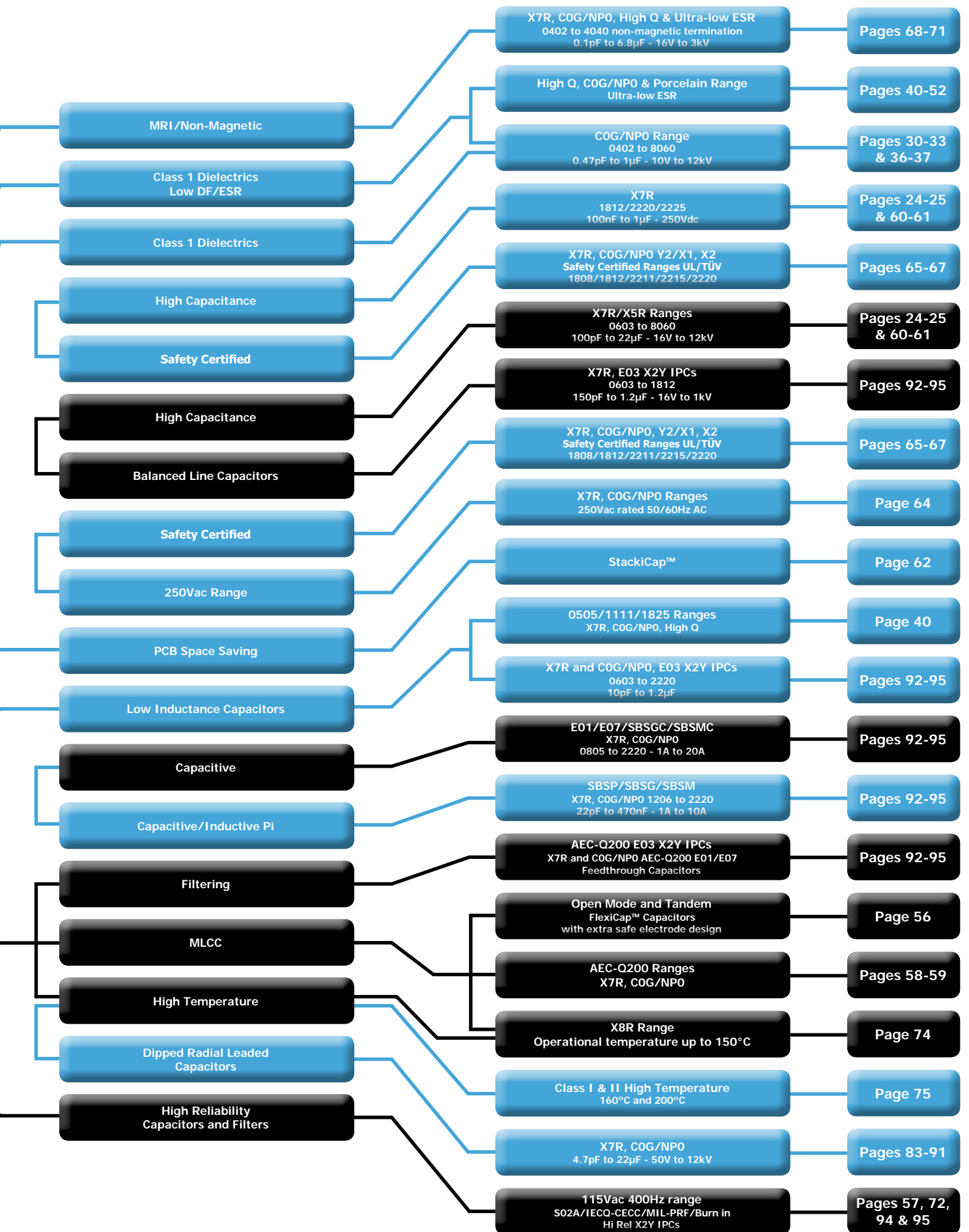

# Contents

<b>General &amp; Technical Introduction</b>	Dielectric classifications and characteristics .....	2-5	
	Termination types including FlexiCap™ .....	6-7	
	Manufacturing processes .....	8	
	Testing .....	9	
	IECQ-CECC and AEC-Q200 Periodic Tests .....	10	
	High Reliability Testing.....	11	
	Regulations and Compliance .....	12	
	Explanation on Ageing of MLC.....	13	
	Handling, Storage, Soldering and Mechanical Precautions.....	14-16	
	Chip Marking System .....	17	
	Packaging Information - Ceramic chip capacitors .....	18-19	
	Chip Dimensions .....	20	
	<hr/>		
	<b>MLCC Ordering Information</b>	Chip Ordering Information .....	<b>DLI</b> ..... 21
Chip Ordering Information .....		<b>Novacap</b> ..... 22	
Chip Ordering Information .....		<b>Syfer</b> ..... 23	
<hr/>			
<b>MLC Capacitors</b>	Quick Reference Guide .....	<b>Novacap-Syfer</b> ..... 24-25	
	Industry Standard - X7R .....	<b>Novacap-Syfer</b> ..... 26-29	
	Industry Standard - COG/NP0 .....	<b>Novacap-Syfer</b> ..... 30-33	
	Other Popular Sizes - X7R .....	<b>Novacap-Syfer</b> ..... 34-35	
	Other Popular Sizes - COG/NP0 .....	<b>Novacap-Syfer</b> ..... 36-37	
	Standard Chip - BX .....	<b>Novacap</b> ..... 38	
	Improved ESR - BX & X7R.....	<b>Novacap</b> ..... 39	
	High Q - Q(MS) & U ranges.....	<b>Syfer</b> ..... 40-42	
	High Q - H range - High Temperature 150°C - X8G .....	<b>Syfer</b> ..... 43-44	
	High Q - High Power RF - Surface Mount & Ribbon Ledged.....	<b>Syfer</b> ..... 45-46	
	High Q Porcelain - CF Series - COG/NP0 .....	<b>DLI</b> ..... 47-49	
	High Q Porcelain - AH Series - P90 .....	<b>DLI</b> ..... 50-52	
	VC1 Residual - X7R.....	<b>Syfer</b> ..... 53	
	TCC/VCC range - (BX & BZ) X7R.....	<b>Syfer</b> ..... 54-55	
	Open Mode and Tandem - X7R.....	<b>Syfer</b> ..... 56	
	IECQ-CECC range - COG/NP0 & X7R .....	<b>Syfer</b> ..... 57	
	Automotive Grade - AEC-Q200 range - MLC, EMI & X2Y .....	<b>Syfer</b> ..... 58-59	
	High Capacitance - X7R & X5R .....	<b>Novacap</b> ..... 60-61	
	StackiCap™ - X7R .....	<b>Syfer</b> ..... 62	
	NC range - X7R.....	<b>Syfer</b> ..... 63	
	250Vac rated 50/60Hz AC.....	<b>Syfer</b> ..... 64	
	250Vac Safety Certified AC.....	<b>Syfer</b> ..... 65-67	
	Non-Magnetic - High Q, COG/NP0 & X7R .....	<b>Syfer-Voltronics</b> ..... 68-69	
	Non-Magnetic - High Power RF - High Q .....	<b>Syfer-Voltronics</b> ..... 68-69	
	Non-Magnetic - High Power RF - High Q - Porcelain P90 & COG/NP0 .....	<b>Voltronics</b> ..... 70-71	
	115Vac 400Hz - COG/NP0 & X7R .....	<b>Syfer</b> ..... 72	
	DWV (High Dielectric Withstand Voltage) range - COG/NP0 & X7R.....	<b>Syfer</b> ..... 73	
	High Temperature - X8R - 150°C .....	<b>Novacap-Syfer</b> ..... 74	
	High Temperature - COG/NP0 & Class II - 160°C & 200°C .....	<b>Novacap</b> ..... 75	
	HiT range of 200°C Caps - COG/NP0 & X7R.....	<b>Novacap-Syfer</b> ..... 76	
	Capacitor Assemblies - ST & SM ranges - COG/NP0 & X7R.....	<b>Novacap</b> ..... 77-81	
	Capacitor Assemblies - 'Cap-Rack' Arrays .....	<b>Novacap</b> ..... 82	
<hr/>			
<b>MLC Radial Leaded Capacitors</b>	Radial Leaded - Ordering Information .....	<b>Novacap-Syfer</b> ..... 83	
	Standard Radial Leaded - COG/NP0, X7R & X8R.....	<b>Novacap</b> ..... 84-85	
	Standard Radial Leaded - COG/NP0, X7R.....	<b>Syfer</b> ..... 86-89	
	High Temperature Radial Leaded - Epoxy Coated .....	<b>Novacap</b> ..... 90	
	High Temperature Radial Leaded - Encapsulated .....	<b>Novacap</b> ..... 91	
<hr/>			
<b>SM EMI Filters</b>	Feedthrough Filters - E01 & E07.....	<b>Syfer</b> ..... 92-93	
	X2Y Integrated Passive Components - E03.....	<b>Syfer</b> ..... 94-95	

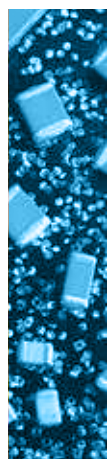

# Dielectric characteristics

## Class I Dielectrics

Multilayer Ceramic Capacitors are generally divided into classes which are defined by the capacitance temperature characteristics over specified temperature ranges. These are designated by alpha numeric codes. Code definitions are summarised below and are also available in the relevant national and international specifications.

Capacitors within this class have a dielectric constant range from 10 to 100. They are used in applications which require ultra stable

dielectric characteristics with negligible dependence of capacitance and dissipation factor with time, voltage and frequency. They exhibit the following characteristics:-

- Time does not significantly affect capacitance and dissipation factor (Tan  $\delta$ ) – no ageing.
- Capacitance and dissipation factor are not affected by voltage.
- Linear temperature coefficient.

		Class I Dielectrics						
		COG/NPO (Porcelain)	P90 (Porcelain)	COG/NPO		X8G	Class I High Temperature	
		Ultra stable	Ultra stable	Ultra stable		Ultra stable	Ultra stable	
Dielectric classifications	IECQ-CECC	-	-	1B/CG		-	-	-
	EIA	COG/NPO	P90	COG/NPO		X8G	-	-
	MIL	-	-	CG (BP)		-	-	-
Ordering code	DLI	CF	AH	-	-	-	-	-
	Novacap	-	-	-	N, RN	-	F	D, RD
	Syfer	-	-	Q, U	C	H	-	G
	Voltronics	F	H	Q	-	-	-	-
Rated temperature range		-55°C to +125°C	-55°C to +125°C	-55°C to +125°C	-55°C to +125°C	-55°C to +150°C	-55°C to +160°C	-55°C to +200°C
Maximum capacitance change over temperature range	No DC voltage applied	0 ±15 ppm/°C	0 ±20 ppm/°C	0 ±30 ppm/°C	0 ±30 ppm/°C	0 ±30 ppm/°C	0 ±30 ppm/°C	0 ±30 ppm/°C
	Rated DC voltage applied	-						
Tangent of loss angle (tan $\delta$ )		≤0.0005 @1MHz		≤0.0005 @1MHz	>50pF ≤0.0015 ≤50pF 0.0015 $\left(\frac{15}{Cr} + 0.7\right)$	≤0.0005 @1MHz	≤0.001	
Insulation resistance (Ri)	Time constant (Ri x Cr)	@25°C = 10 <sup>6</sup> MΩ min @125°C = 10 <sup>5</sup> MΩ min		100GΩ or 1000s (whichever is the least)			@25°C = 100GΩ or 1000ΩF @160°C & 200°C = 1GΩ or 10ΩF (whichever is the least)	
Capacitance Tolerance	Cr <4.7pF	±0.05pF, ±0.10pF, ±0.25pF, ±0.5pF						
	Cr ≥4.7 to <10pF	±0.10pF, ±0.25pF, ±0.5pF						
	Cr ≥10pF	±1%, ±2%, ±5%, ±10%						
Dielectric strength Voltage applied for 5 seconds. Charging current limited to 50mA maximum.	≤200V	2.5 times	2.5 times	2.5 times				
	>200V to <500V			Rated voltage +250V				
	500V to ≤1kV			1.5 times				
	>1kV to ≤1.2kV			1.25 times				
	>1.2kV			1.2 times				
Climatic category (IEC)	Chip	-	-	55/125/56		-	-	
	Dipped	-	-	-	55/125/21	-	-	
	Discoidal	-	-	-	55/125/56	-	-	
Ageing characteristic (Typical)		Zero						
Approvals	Syfer Chip	-	-	-	QC-32100	-	-	

# Dielectric characteristics

## Class II Dielectrics

Capacitors of this type have a dielectric constant range of 1000-4000 and also have a non-linear temperature characteristic which exhibits a dielectric constant variation of less than  $\pm 15\%$  (2R1) from its room temperature value, over the specified temperature range. Generally used for by-passing (decoupling), coupling, filtering, frequency discrimination, DC blocking and voltage transient suppression with greater volumetric efficiency than Class I units, whilst maintaining stability within defined limits.

Capacitance and dissipation factor are affected by:-

- Time (Ageing)
- Voltage (AC or DC)
- Frequency

Class II Dielectrics								
X5R	X7R			X8R	Class II High Temperature			
Stable	Stable			Stable	Stable			
-	2C1	2R1	2X1	-	-	-	IECQ-CECC	Dielectric classifications
X5R	-	X7R	-	X8R	-	-	EIA	
-	BZ	-	BX	-	-	-	MIL	
-	-	-	-	-	-	-	DLI	Ordering code
BW	-	B, RB	X	S	G	E, RE	Novacap	
P	R	X	B	N	-	X	Syfer	
-	-	X	-	-	-	-	Voltronics	
-55°C to +85°C	-55°C to +125°C			-55°C to +150°C	-55°C to +160°C	-55°C to +200°C		Rated temperature range
$\pm 15\%$	$\pm 15\%$	$\pm 15\%$	$\pm 15\%$	$\pm 15\%$	+15 -40%	+15 -65%	No DC voltage applied	Maximum capacitance change over temperature range
-	+15 -45%	-	+15 -25%	-	-	-	Rated DC voltage applied	
$\leq 0.025$ Typical*	$>25V \leq 0.025$ $\leq 25V \leq 0.035$			$\leq 0.025$	$\leq 0.025$			Tangent of loss angle ( $\tan \delta$ )
100G $\Omega$ or 1000s (whichever is the least)							Time constant ( $R_i \times C_r$ )	Insulation resistance ( $R_i$ )
$\pm 5\%$ , $\pm 10\%$ , $\pm 20\%$								Capacitance Tolerance
2.5 times							$\leq 200V$	Dielectric strength Voltage applied for 5 seconds. Charging current limited to 50mA maximum.
Rated voltage +250V							$>200V$ to $<500V$	
1.5 times							500V to $<1kV$	
1.2 times							$\geq 1kV$	
55/85/56	55/125/56			55/150/56	-		Chip	Climatic category (IEC)
-	55/125/21			-	-		Dipped	
-	55/125/56			-	-		Discoidal	
5% Typical	$<2\%$ per time decade							Ageing characteristic (Typical)
-	QC-32100	-	-	-	QC-32100	-	Syfer Chip	Approvals

\* Refer to page 61 for details of Dissipation Factor.



# Dielectric characteristics

## Typical dielectric temperature characteristics

Porcelain COG/NP0 & P90

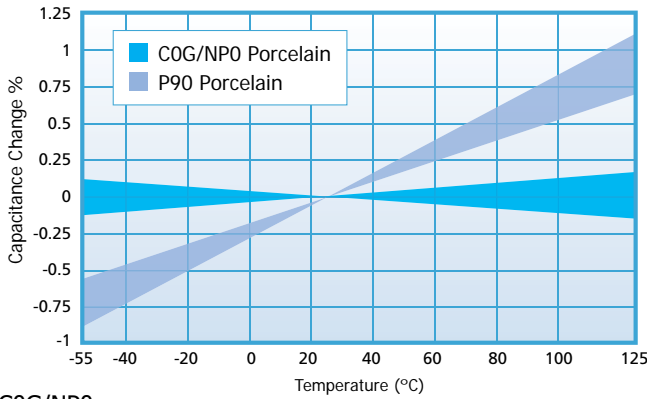

COG/NP0

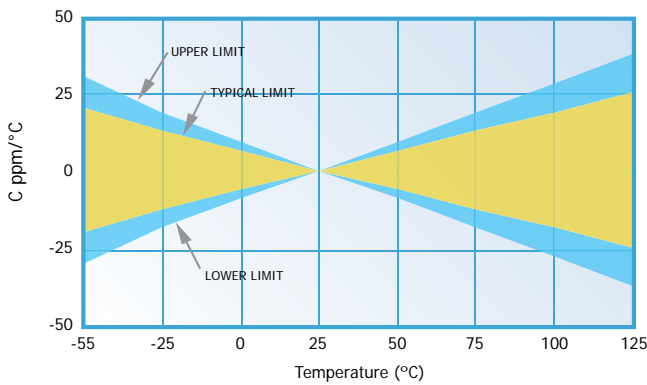

X7R

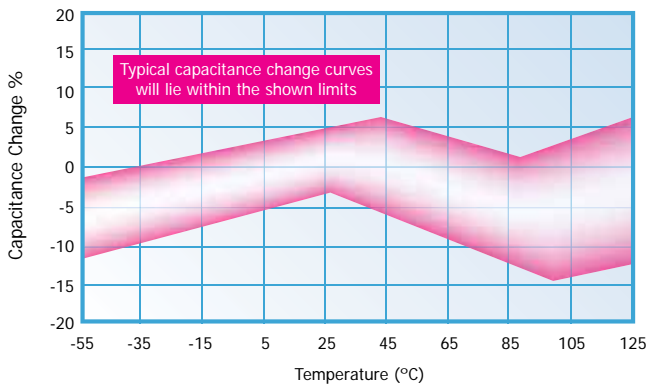

## Impedance vs Frequency

Ultra Stable COG/NP0 dielectric

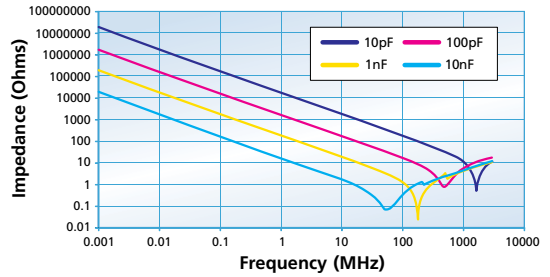

Stable X7R dielectric

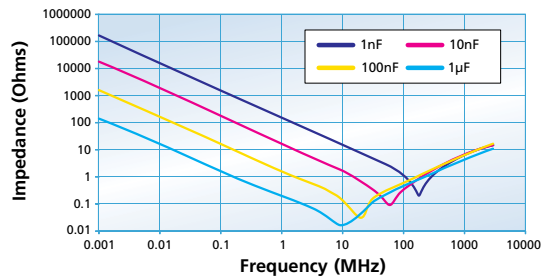

Stable X7R dielectric - 10nF

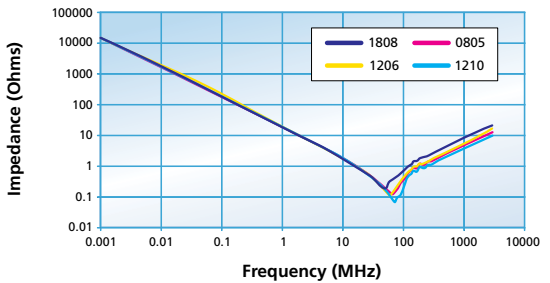

## ESR vs Frequency - chips

Ultra Stable COG/NP0 dielectric

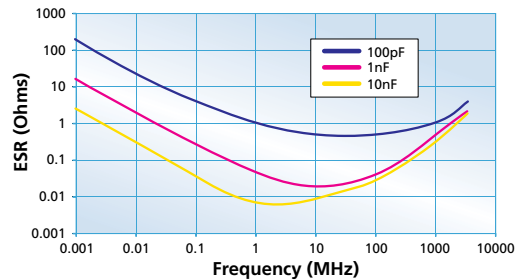

Stable X7R dielectric

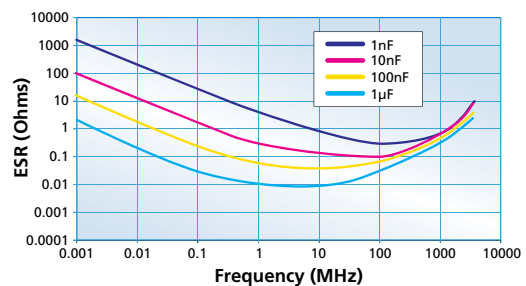



# Dielectric characteristics - Porcelain COG/NPO & P90

## Typical ESR and Series Resonance characteristics

CF Porcelain (COG/NPO) and AH Porcelain (P90)

Dielectric	DLI Series	Cap (pF)	Typical ESR			Series Resonance (MHz)	
			150 MHz	500 MHz	1 GHz		
<b>CF</b> TCC (ppm/°C) (-55° to +125°C) Porcelain (COG/NPO) 0 ± 15	C06CF 0603	1	0.182	0.276	0.428	10300	
		10	0.095	0.159	0.243	3200	
		47	0.081	0.127	0.173	1400	
	C11CF 0505	1	0.073	0.089	0.146	9900	
		10	0.049	0.075	0.107	3100	
		100	0.040	0.073	0.111	970	
	C17CF 1111	1	0.073	0.082	0.124	9060	
		10	0.065	0.098	0.136	3100	
		100	0.041	0.070	0.102	1300	
		1000	0.034	0.073	–	400	
	C18CF 1111	1	0.068	0.086	0.158	9060	
		10	0.058	0.087	0.118	3100	
		1000	0.041	0.068	–	1000	
	C22CF 2225	10	0.072	0.113	0.164	2480	
		100	0.047	0.079	0.119	1000	
		1000	0.036	0.067	–	320	
		2700	0.035	–	–	214	
				10MHz	30MHz	100MHz	
	C40CF 3838	10	0.121	0.054	0.037	2100	
		100	0.044	0.038	0.045	680	
1000		0.032	0.036	0.038	210		
5100		0.011	0.016	0.040	95		
<b>AH</b> TCC (ppm/°C) (-55° to +125°C) Porcelain (P90) +90 ± 20	C11AH 0505	1	0.067	0.08	0.136	9200	
		10	0.044	0.071	0.104	3000	
		100	0.032	0.055	0.086	1000	
	C17AH 1111	1	0.059	0.063	0.114	9064	
		10	0.039	0.06	0.085	3100	
		1000	0.024	0.05	0.074	1290	
	C18AH 1111	10	0.059	0.094	0.138	3100	
		100	0.028	0.069	0.109	1290	
		1000	0.023	0.063	–	400	
	C22AH 2225	10	0.074	0.207	0.249	2480	
		100	0.048	0.116	0.19	1000	
		1000	0.028	0.14	–	320	
		2700	0.027	–	–	214	
				10MHz	30MHz	100MHz	
	C40AH 3838	15	0.066	0.033	0.027	2100	
		100	0.018	0.026	0.052	680	
		1000	0.009	0.017	0.033	210	
		5100	0.008	0.016	0.033	95	

# Dielectric termination combinations



		Palladium Silver	Palladium Silver	Nickel Barrier (100% matte tin plating), Lead free	Nickel Barrier 90/10% tin/lead	Nickel Barrier Gold flash	FlexiCap™ with Nickel Barrier 100% tin	FlexiCap™ with Nickel Barrier 90/10% tin/lead	FlexiCap™ with Copper Barrier 100% tin	FlexiCap™ Ag Layer, 400-u-in Cu barrier, 200-u-in Sn Plate	FlexiCap™ with Copper Barrier 90/10% tin/lead	Copper Barrier 100% tin	Ag Layer, 400-500u-in Cu barrier, 200-u-in 90/10 Sn Plate	Copper Barrier 90/10% tin/lead	Solderable Silver	Solderable Palladium Silver	Ag termination, Ni Barrier, Heavy SnPB Plated Solder	Ag termination, Enhanced Ni Barrier, Sn Plated Solder	Ag termination, Enhanced Cu Barrier, Sn Plated Solder	Ag Termination, Cu Barrier Layer, Heavy SnPB Plated Solder	
		RoHS	RoHS	RoHS	RoHS	RoHS	RoHS	RoHS	RoHS	RoHS	RoHS	RoHS	RoHS	RoHS	RoHS	RoHS	RoHS	RoHS	RoHS	RoHS	
Recommended for Solder Attachment				●	●		●	●	●	●	●	●	●	●	●	●	●	●	●	●	●
Recommended for Conductive Epoxy Attachment		●	●			●															
Termination ordering code:	DLI	-	P	Z	U	S	Q	Y	M	-	-	W	-	V	-	-	T	E	H	R	
	Novacap	P	PR	N	Y	NG	C	D	-	-	-	B	-	E	S	K	-	-	-	-	
	Syfer	-	F	J	A	-	Y	H	3	-	5	2	-	4	-	-	-	-	-	-	
	Voltronics	-	S	-	-	-	-	-	3	M	-	2	W	-	-	-	-	-	-	-	
Dielectric	Code																				
NPO Porcelain - HI Q	DLI - CF		●	●	●	●	●	●				●		●			●	●	●	●	
P90 Porcelain - HI Q	DLI - AH		●	●	●	●	●	●				●		●			●	●	●	●	
COG - HI Q/Low ESR	Syfer - Q, U			●	●																
COG - HI Q/Low ESR BME	Syfer - H			●																	
COG/NPO	Novacap - N/RN	●	●	●	●	●	●	●								●	●				
	Syfer - A			●	●		●	●													
	Syfer - C, F		●	●	●		●	●													
COG/NPO - BME	Syfer - G, K			●	●		●	●													
COG/NPO - Non-Mag	Novacap - M	●	●									●		●			●				
	Syfer - C, Q								●		●	●		●							
	Voltronics - Q		●							●		●	●								
X5R	Syfer - P		●	●	●		●	●													
	Novacap - BW			●	●	●															
X7R	Novacap - B/RB	●	●	●	●	●	●	●								●	●				
	Syfer - E							●	●												
X7R - BME	Syfer - X, D		●	●	●		●	●													
	Novacap - BB			●	●	●															
	Syfer - J			●				●	●												
BX	Syfer - S							●	●												
	Novacap - X	●	●	●	●	●	●	●								●	●				
	Syfer - B		●	●	●		●	●													
BZ	Syfer - R		●	●	●		●	●													
	Novacap - C	●	●									●		●			●				
	Syfer - X								●		●			●							
X7R - Non-Mag	Voltronics - X		●						●	●			●								
	Novacap - S	●	●	●	●		●	●								●	●				
	Syfer - N		●	●	●		●	●													
X8R	Syfer - T							●	●												
	Novacap - F	●	●	●	●		●	●								●	●				
	Novacap - D															●	●				
COG/NPO (160°C)	Novacap - RD			●																	
	Syfer - G			●																	
Class II (160°C)	Novacap - G	●	●	●	●		●	●								●	●				
	Novacap - E															●	●				
	Novacap - RE			●																	
Class II (200°C)	Syfer - X			●																	

Dielectric codes in Red - AEC-Q200 qualified. Dielectric codes in Green - IECQ-CECC.

# FlexiCap™ overview

## FlexiCap™ termination

MLCCs are widely used in electronic circuit design for a multitude of applications. Their small package size, technical performance and suitability for automated assembly makes them the component of choice for the specifier.

However, despite the technical benefits, ceramic components are brittle and need careful handling on the production floor. In some circumstances they may be prone to mechanical stress damage if not used in an appropriate manner. Board flexing, depanelisation, mounting through hole components, poor storage and automatic testing may all result in cracking.

Careful process control is important at all stages of circuit board assembly and transportation - from component placement to test and packaging. Any significant board flexing may result in stress fractures in ceramic devices that may not always be evident during the board assembly process. Sometimes it may be the end customer who finds out - when equipment fails!

## Knowles has the solution - FlexiCap™

FlexiCap™ has been developed as a result of listening to customers' experiences of stress damage to MLCCs from many manufacturers, often caused by variations in production processes.

Our answer is a proprietary flexible epoxy polymer termination material, that is applied to the device under the usual nickel barrier finish. FlexiCap™ will accommodate a greater degree of board bending than conventional capacitors.

## Knowles FlexiCap™ termination

Ranges are available with FlexiCap™ termination material offering increased reliability and superior mechanical performance (board flex and temperature cycling) when compared with standard termination materials. Refer to Knowles application note reference AN0001. FlexiCap™ capacitors enable the board to be bent almost twice as much before mechanical cracking occurs. Refer to application note AN0002.

FlexiCap™ is also suitable for Space applications having passed thermal vacuum outgassing tests. Refer to Syfer application note reference AN0026.

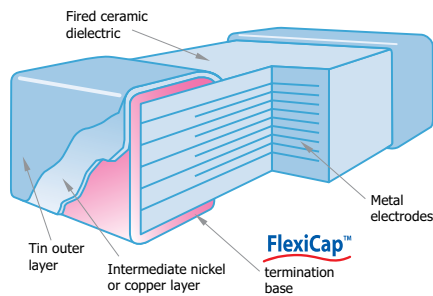

FlexiCap™ MLCC cross section

## FlexiCap™ benefits

With traditional termination materials and assembly, the chain of materials from bare PCB to soldered termination, provides no flexibility. In circumstances where excessive stress is applied - the weakest link fails. This means the ceramic itself, which may fail short circuit.

The benefit to the user is to facilitate a wider process window - giving a greater safety margin and substantially reducing the typical root causes of mechanical stress cracking.

FlexiCap™ may be soldered using your traditional wave or reflow solder techniques including lead free and needs no adjustment to equipment or current processes.

Knowles has delivered millions of FlexiCap™ components and during that time has collected substantial test and reliability data,

working in partnership with customers world wide, to eliminate mechanical cracking.

An additional benefit of FlexiCap™ is that MLCCs can withstand temperature cycling -55°C to 125°C in excess of 1,000 times without cracking.

FlexiCap™ termination has no adverse effect on any electrical parameters, nor affects the operation of the MLCC in any way.

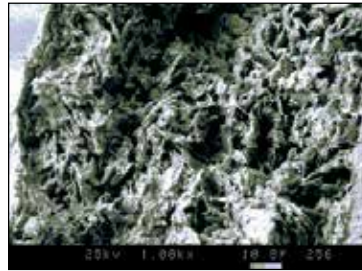

● Picture taken at 1,000x magnification using a SEM to demonstrate the fibrous nature of the FlexiCap™ termination that absorbs increased levels of mechanical stress.

## Available on the following ranges:

- All High Reliability ranges
- Standard and High Voltage Capacitors
- Open Mode and Tandem Capacitors
- Safety Certified Capacitors
- Non-magnetic Capacitors
- 3 terminal EMI chips
- X2Y Integrated Passive Components
- X8R High Temperature capacitors

## Summary of PCB bend test results

The bend tests conducted on X7R have proven that the FlexiCap™ termination withstands a greater level of mechanical stress before mechanical cracking occurs.

The AEC-Q200 test for X7R requires a bend level of 2mm minimum and a cap change of less than 10%.

Product X7R	Typical bend performance under AEC-Q200 test conditions
Standard termination	2mm to 3mm
FlexiCap™	Typically 8mm to 10mm

## Application notes

FlexiCap™ may be handled, stored and transported in the same manner as standard terminated capacitors. The requirements for mounting and soldering FlexiCap™ are the same as for standard SMD capacitors.

For customers currently using standard terminated capacitors there should be no requirement to change the assembly process when converting to FlexiCap™.

Based upon board bend tests in accordance with IEC 60384-1 the amount of board bending required to mechanically crack a FlexiCap™ terminated capacitor is significantly increased compared with standard terminated capacitors.

It must be stressed however, that capacitor users must not assume that the use of FlexiCap™ terminated capacitors will totally eliminate mechanical cracking. Good process controls are still required for this objective to be achieved.



# Manufacturing processes

## Production process flowchart

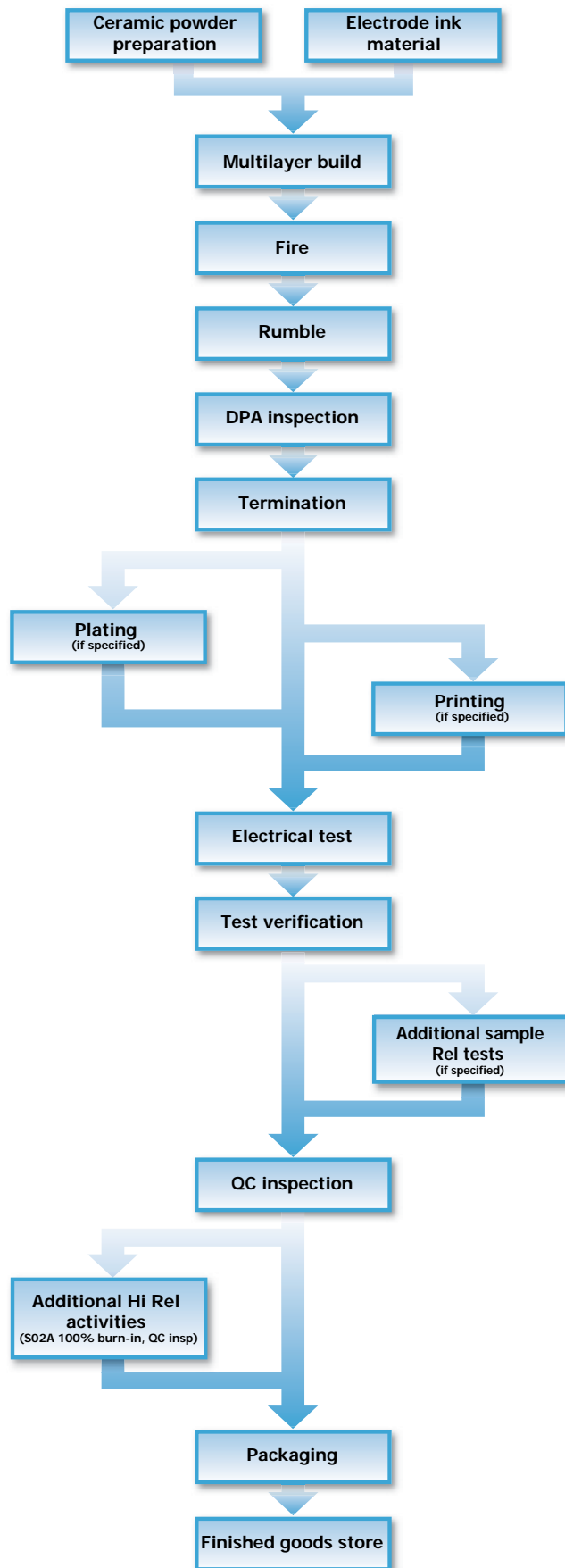

## Knowles reliability grades

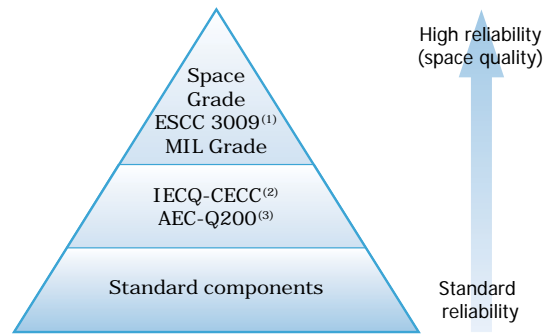

Notes:

- 1) Space grade tested in accordance with ESCC3009 (refer to Knowles Spec S02A 0100) or MIL Grade (in accordance with MIL-PRF-123, MIL-PRF-55681).
- 2) IECQ-CECC. The International Electrotechnical Commission (IEC) Quality Assessment System for Electronic Components. This is an internationally recognised product quality certification which provides customers with assurance that the product supplied meets high quality standards.  
View Knowles IECQ-CECC approvals at <http://www.iecq.org> or at [www.knowlesc capacitors.com](http://www.knowlesc capacitors.com)
- 3) AEC-Q200. Automotive Electronics Council Stress Test Qualification For Passive Components. Refer to Knowles application note reference AN0009.

## Knowles reliability surface mount product groups

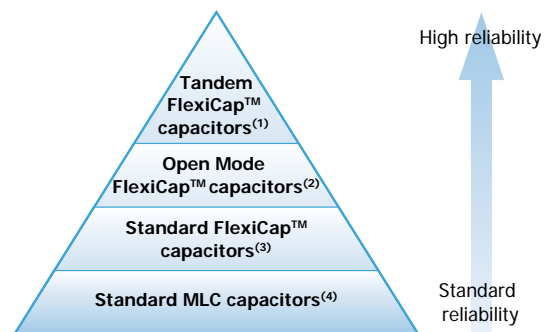

Notes:

- 1) "Tandem" construction capacitors, ie internally having the equivalent of 2 series capacitors. If one of these should fail short-circuit, there is still capacitance end to end and the chip will still function as a capacitor, although capacitance maybe affected. Refer to application note AN0021. Also available qualified to AEC-Q200.
- 2) "Open Mode" capacitors with FlexiCap™ termination also reduce the possibility of a short circuit by utilising inset electrode margins. Refer to application note AN0022. Also available qualified to AEC-Q200.
- 3) Multilayer capacitors with Knowles FlexiCap™ termination. By using FlexiCap™ termination, there is a reduced possibility of the mechanical cracking occurring.
- 4) "Standard" capacitors includes MLCCs with tin finish over nickel but no FlexiCap™.

# Testing

## Tests conducted during batch manufacture

	Knowles reliability SM product group			
	Standard SM capacitors	IECQ-CECC / MIL grade	AEC-Q200	S (Space grade) High Rel S02A ESCC 3009 MIL-PRF-123
Solderability	●	●	●	●
Resistance to soldering heat	●	●	●	●
Plating thickness verification (if plated)	●	●	●	●
DPA (Destructive Physical Analysis)	●	●	●	●
Voltage proof test (DWW / Flash)	●	●	●	●
Insulation resistance	●	●	●	●
Capacitance test	●	●	●	●
Dissipation factor test	●	●	●	●
100% visual inspection	○	○	●	●
100% burn-in. (2xRV @125°C for 168 hours)	○	○	○	●
Load sample test @ 125°C	○	○	●	LAT1 & LAT2 (1000 hours)
Humidity sample test. 85°C/85%RH	○	○	●	240 hours
Hot IR sample test	○	○	○	○
Axial pull sample test (MIL-STD-123)	○	○	○	○
Breakdown voltage sample test	○	○	○	○
Deflection (bend) sample test	○	○	○	○
SAM (Scanning Acoustic Microscopy)	○	○	○	○
LAT1 (4 x adhesion, 8 x rapid temp change + LAT2 and LAT3)	-	-	-	○
LAT2 (20 x 1000 hour life test + LAT3)	-	-	-	○
LAT3 (6 x TC and 4 x solderability)	-	-	-	○

- Test conducted as standard.
- Optional test. Please discuss with the Sales Office.



## Periodic tests conducted for IECQ-CECC and AEC-Q200

Test ref	Test	Termination type	Additional requirements	Sample acceptance			Reference
				P	N	C	
P1	High temperature exposure (storage)	All types	Un-powered. 1,000 hours @ T=150°C. Measurement at 24 ± 2 hours after test conclusion	12	77	0	MIL-STD-202 Method 108
P2	Temperature cycling	C0G/NP0: All types X7R: Y and H only	1,000 cycles -55°C to +125°C Measurement at 24 ± 2 hours after test conclusion	12	77	0	JESD22 Method JA-104
P3	Moisture resistance	All types	T = 24 hours/cycle. Note: Steps 7a and 7b not required. Un-powered. Measurement at 24 ± 2 hours after test conclusion	12	77	0	MIL-STD-202 Method 106
P4	Biased humidity	All types	1,000 hours 85°C/85%RH. Rated voltage or 50V whichever is the least and 1.5V. Measurement at 24 ± 2 hours after test conclusion	12	77	0	MIL-STD-202 Method 103
P5	Operational life	All types	Condition D steady state TA=125°C at full rated. Measurement at 24 ± 2 hours after test conclusion	12	77	0	MIL-STD-202 Method 108
P6	Resistance to solvents	All types	Note: Add aqueous wash chemical. Do not use banned solvents	12	5	0	MIL-STD-202 Method 215
P7	Mechanical shock	C0G/NP0: All types X7R: Y and H only	Figure 1 of Method 213. Condition F	12	30	0	MIL-STD-202 Method 213
P8	Vibration	C0G/NP0: All types X7R: Y and H only	5g's for 20 minutes, 12 cycles each of 3 orientations. Note: Use 8" x 5" PCB 0.031" thick 7 secure points on one long side and 2 secure points at corners of opposite sides. Parts mounted within 2" from any secure point. Test from 10-2,000Hz	12	30	0	MIL-STD-202 Method 204
P9	Resistance to soldering heat	All types	Condition B, no pre-heat of samples: Single wave solder - Procedure 2	3	12	0	MIL-STD-202 Method 210
P10	Thermal shock	C0G/NP0: All types X7R: Y and H only	-55°C/+125°C. Number of cycles 300. Maximum transfer time - 20 seconds, dwell time - 15 minutes. Air-Air	12	30	0	MIL-STD-202 Method 107
P11	Adhesion, rapid temp change and climatic sequence	X7R: A, F and J only	5N force applied for 10s, -55°C/ +125°C for 5 cycles, damp heat cycles	12	27	0	BS EN132100 Clause 4.8, 4.12 and 4.13
P12	Board flex	C0G/NP0: All types X7R: Y and H only	3mm deflection Class I 2mm deflection Class II	12	30	0	AEC-Q200-005
P13	Board flex	X7R: A, F and J only	1mm deflection.	12	12	0	BS EN132100 Clause 4.9
P14	Terminal strength	All types	Force of 1.8kg for 60 seconds	12	30	0	AEC-Q200-006
P15	Beam load test	All types	-	12	30	0	AEC-Q200-003
P16	Damp heat steady state	All types	56 days, 40°C / 93% RH 15x no volts, 15x 5Vdc, 15x rated voltage or 50V whichever is the least.	12	45	0	BS EN132100 Clause 4.14

Test results are available on request.

P = Period in months.

N = Sample size.

C = Acceptance criteria.

# High Reliability Testing

Our High Rel products are designed for optimum reliability and are burned in at elevated voltage and temperature levels. They are 100% electrically inspected to ascertain conformance to a strict performance criteria.

Applications for High Reliability products include medical implanted devices, aerospace, airborne, various military applications, and consumer uses requiring safety margins not attainable with conventional product.

We have the ability to test surface mount and leaded capacitors to High Reliability standards as detailed below, or to customer SCD.

Military performance specifications are designed and written for the voltage/capacitance ratings of the individual product slash numbers associated with the specification.

Some of the requirements of the military document may not apply to the High Reliability product. The following details the intent of the individual military specifications available for test and the deviations that may apply.

Product voltage ratings outside of the intended military specification will follow the voltage test potential outlined.

Contact the Sales Office with any requirements or deviations that are not covered here.

## Environmental Testing

We also have the capability to perform all the Environmental Group B, Group C and Qualification testing to the referenced military specifications.

Testing abilities include the following:

- Nondestructive internal examination
- Destructive physical analysis
- Radiographic inspection
- Terminal strength
- Resistance to soldering heat
- Voltage-temperature limits
- Temperature coefficient
- Moisture resistance
- Humidity, steady state, low voltage
- Vibration
- Resistance to solvents
- Life
- Thermal shock and immersion
- Low temperature storage
- Barometric pressure
- Shock, specified pulse
- Mechanical shock
- Constant acceleration
- Wire bond evaluation
- Partial discharge (corona)
- 200°C Voltage Conditioning

## Military Performance Specifications

### MIL-PRF-55681 (GROUP A)

General purpose military high reliability specification for surface mount sizes 0805 through 2225 in 50V and 100V.

- VOLTAGE CONDITIONING
- 100 HRS, 2X VDCW, 125°C
- DWV, IR, 125°C IR, CAP, DF TEST
- VISUAL & MECH. INSPECTION (AQL SAMPLE PLAN)
- SOLDERABILITY, SAMPLE 13(0)
- 8% PDA MAXIMUM

### MIL-PRF-123 (GROUP A)

The specification affords an increased reliability level over MIL-PRF-55681 for space, missile and other high reliability applications such as medical implantable or life support equipment. The specification covers surface mount sizes 0805 through 2225 in 50V rating and various radial / axial leaded products in 50V, 100V and 200V ratings.

- THERMAL SHOCK, 20 CYCLES
- VOLTAGE CONDITIONING 168/264 HRS, 2X VDCW, 125°C
- DWV, IR, 125°C IR, CAP, DF TEST
- VISUAL & MECH. INSPECTION SAMPLE 20(0)
- DPA<sup>(1)</sup>
- PDA, 3% (0.1%), 5% (0.2%) MAX<sup>(2)</sup>

### MIL-PRF-39014 (GROUP A)

The specification covers general military purpose radial / axial leaded and encapsulated product in 50V, 100V, and 200V ratings.

- THERMAL SHOCK, 5 CYCLES
- VOLTAGE CONDITIONING 96 HRS, 2X VDCW, 125°C
- DWV, IR, 125°C IR, CAP, DF TEST
- VISUAL & MECH. INSPECTION (AQL SAMPLE PLAN)
- SOLDERABILITY, SAMPLE 13(0)
- 8% PDA MAXIMUM

### MIL-PRF-49467 (GROUP A)

General purpose military high reliability specification for radial leaded epoxy coated. The specification covers sizes 1515 through 13060 with 600V, 1kV, 2kV, 3kV, 4kV and 5kV ratings.

- THERMAL SHOCK, 5 CYCLES
- VOLTAGE CONDITIONING 96 HRS, RATED VDCW, 125°C
- PARTIAL DISCHARGE (OPTION)<sup>(3)</sup>
- DWV, IR, 125°C IR, CAP, DF TEST
- VISUAL & MECH. INSPECTION SAMPLE 13(0)
- SOLDERABILITY, SAMPLE 5(0)
- 10% PDA MAXIMUM

### MIL-PRF-49470 (DSCC 87106) (GROUP A)

General purpose military high reliability specification for stacked and leaded capacitors for switch mode power supplies. The specification covers sizes 2225 through 120200 in 50V, 100V, 200V and 500V ratings.

- THERMAL SHOCK, 5 CYCLES
- VOLTAGE CONDITIONING 96 HRS, 2X VDCW<sup>(4)</sup>, 125°C
- DWV, IR, 125°C IR, CAP, DF TEST
- VISUAL & MECH. INSPECTION SAMPLE 13(0)
- SOLDERABILITY, SAMPLE 5(0)
- 10% PDA MAXIMUM

### MIL-PRF-38534

Specification for Hybrid Microcircuits with a section for Element Evaluation on passive components.

There are two classification levels of reliability. Class H is for a standard military quality level. Class K is for the highest reliability level intended for space application.

Knowles will perform a 100-hour burn-in on all Class K products and assumes Class K Subgroup 3 samples will be unmounted and Subgroup 4 (wirebond) shall not apply unless otherwise stated.

### TEST VOLTAGE (VDC)

This test potential shall be used on all High Reliability Testing unless otherwise specified.

WVDC	DWV	V/C*
<200	2.5X Rated	2.0X Rated
250	500V	400V
300	500V	400V
400	600V	500V
500	750V	600V
600	750V	600V
*V/C Is Voltage Conditioning.	>700	1.2X Rated 1.0X Rated

#### Notes:

1. MIL-PRF-123 DPA shall be per TABLE XIV AQL requirements unless otherwise specified.
2. MIL-PRF-123 allowable PDA shall be 3% overall and 0.1% in the last 48 hours for capacitance/voltage values listed in MIL-PRF-123, and be 5% overall and 0.2% in the last 48 hours for capacitance/voltage values beyond MIL-PRF-123.
3. MIL-PRF-49467 standard Group A is without Partial Discharge. Partial Discharge test is optional and must be specified.
4. MIL-PRF-49470 (DSCC 87106) 500V rated product has Voltage Conditioning at 1.2X VDCW.

# Regulations and Compliance

## Release documentation

Certificate of conformance	●
IECQ-CECC Release certificate of conformity	-
Batch electrical test report	○
S (space grade) data documentation package	-

- Release documentation supplied as standard.
- Original documentation.

Knowles reliability SM product group			
Standard SM capacitors	IECQ-CECC	AEC-Q200 MIL grade	S (Space grade) High Rel S02A
●	-	●	●
-	●	-	-
○	○	○	Included in data pack
-	-	-	●

## Periodic tests conducted and reliability data availability

### Standard Surface Mount capacitors

Components are randomly selected on a sample basis and the following routine tests are conducted:

- Load Test. 1,000 hours @125°C (150°C for X8R). Applied voltage depends on components tested.
- Humidity Test. 168 hours @ 85°C/85%RH.
- Board Deflection (bend test).

Test results are available on request.

### Conversion factors

From	To	Operation
FITS	MTBF (hours)	$10^9 \div \text{FITS}$
FITS	MTBF (years)	$10^9 \div (\text{FITS} \times 8760)$

FITS = Failures in  $10^9$  hours.

MTBF = Mean time between failures.

### Example of FIT (Failure In Time) data available:

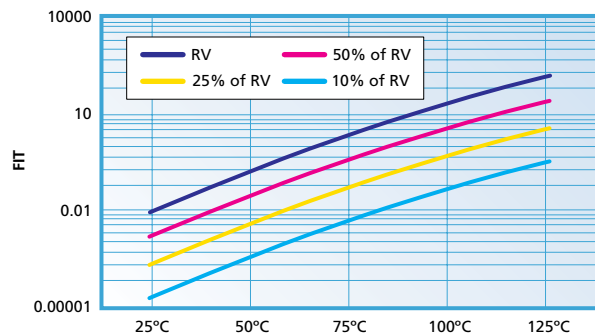

Component type: 0805 (COG/NPO and X7R).

Testing location: Knowles reliability test department.

Results based on: 16,622,000 component test hours.

## REACH (Registration, Evaluation, Authorisation and restriction of Chemicals) statement

The main purpose of REACH is to improve the protection of human health and the environment from the risks arising from the use of chemicals.

Knowles maintains both ISO14001, Environmental Management System and OHSAS 18001 Health and Safety Management System approvals that require and ensure compliance with corresponding legislation such as REACH.

For further information, please contact the Knowles Capacitors Sales Office at [www.knowlescapacitors.com](http://www.knowlescapacitors.com)

### RoHS compliance

Knowles routinely monitors world wide material restrictions (e.g. EU/China and Korea RoHS mandates) and is actively involved in shaping future legislation.

All standard COG/NPO, X7R, X5R and High Q Knowles MLCC products are compliant with the EU RoHS directive (see below

for special exceptions) and those with plated terminations are suitable for soldering using common lead free solder alloys (refer to 'Soldering Information' for more details on soldering limitations). Compliance with the EU RoHS directive automatically signifies compliance with some other legislation (e.g. China and Korea RoHS). Please refer to the Knowles Capacitors Sales Office for details of compliance with other materials legislation.

Breakdown of material content, SGS analysis reports and tin whisker test results are available on request.

Most Knowles MLCC components are available with non RoHS compliant tin lead (SnPb) solderable termination finish for exempt applications and where pure tin is not acceptable. Other tin free termination finishes may also be available – please refer to the Knowles Capacitors Sales Office for further details.

Radial components have tin plated leads as standard but tin/lead is available as a special option. Please refer to the radial section of the catalogue for further details.

X8R ranges <250Vdc are not RoHS 2011/65/EU compliant. Check the website, [www.knowlescapacitors.com](http://www.knowlescapacitors.com) for latest RoHS update.

## Export controls and dual-use regulations

Certain Knowles catalogue components are defined as 'dual-use' items under international export controls - those that can be used for civil or military purposes which meet certain specified technical standards.

The defining criteria for a dual use component with respect to Knowles Capacitor products is one with a voltage rating of >750Vdc

and a capacitance value of >250nF when measured at 750Vdc and a series inductance <10nH. Components defined as dual-use under the above criteria may require a licence for export across international borders. Please contact the Sales Office for further information on specific part numbers.



# Explanation of Ageing of MLC

## Ageing

Capacitor ageing is a term used to describe the negative, logarithmic capacitance change which takes place in ceramic capacitors with time. The crystalline structure for barium titanate based ceramics changes on passing through its Curie temperature (known as the Curie Point) at about 125°C. This domain structure relaxes with time and in doing so, the dielectric constant reduces logarithmically; this is known as the ageing mechanism of the dielectric constant. The more stable dielectrics have the lowest ageing rates.

The ageing process is reversible and repeatable. Whenever the capacitor is heated to a temperature above the Curie Point the ageing process starts again from zero.

The ageing constant, or ageing rate, is defined as the percentage loss of capacitance due to the ageing process of the dielectric which occurs during a decade of time (a tenfold increase in age) and is expressed as percent per logarithmic decade of hours. As the law of decrease of capacitance is logarithmic, this means that in a capacitor with an ageing rate of 1% per decade of time, the capacitance will decrease at a rate of:

- a) 1% between 1 and 10 hours
- b) An additional 1% between the following 10 and 100 hours
- c) An additional 1% between the following 100 and 1000 hours
- d) An additional 1% between the following 1000 and 10000 hours etc
- e) The ageing rate continues in this manner throughout the capacitor's life.

Typical values of the ageing constant for our Multilayer Ceramic Capacitors are:

Dielectric class	Typical values
Ultra Stable COG/NPO	Negligible capacitance loss through ageing
Stable X7R	<2% per decade of time

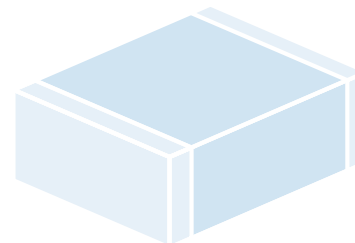
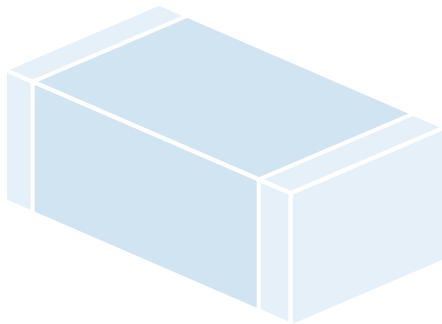

## Capacitance measurements

Because of ageing it is necessary to specify an age for reference measurements at which the capacitance shall be within the prescribed tolerance. This is fixed at 1000 hours, since for practical purposes there is not much further loss of capacitance after this time.

All capacitors shipped are within their specified tolerance at the standard reference age of 1000 hours after having cooled through their Curie temperature.

The ageing curve for any ceramic dielectric is a straight line when plotted on semi-log paper.

## Capacitance vs time

(Ageing X7R @ <2% per decade)

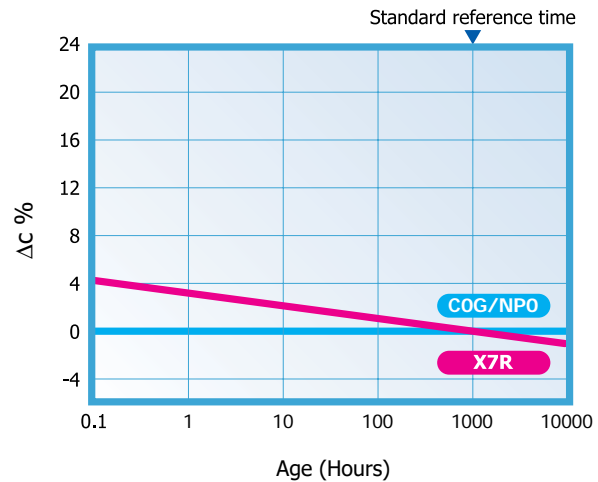

## Tight tolerance

One of the advantages of Knowles' unique 'wet process' of manufacture is the ability to offer capacitors with exceptionally tight capacitance tolerances.

The accuracy of the printing screens used in the fully automated, computer controlled manufacturing process allows for tolerance as close as +/-1% on COG/NPO parts greater than or equal to 10pF. For capacitance values below <4.7pF, tolerances can be as tight as +/-0.05pF.

# Mounting, Soldering, Storage & Mechanical Precautions

Detailed application notes intended to guide and assist our customers in using multilayer ceramic capacitors in surface mount technology are available on the Knowles website [www.knowlescapacitors.com](http://www.knowlescapacitors.com)

The information concentrates on the handling, mounting, connection, cleaning, test and re-work requirements particular to MLC's for SMD technology, to ensure a suitable match between component capability and user expectation. Some extracts are given below.

## Mechanical considerations for mounted ceramic chip capacitors

Due to their brittle nature, ceramic chip capacitors are more prone to excesses of mechanical stress than other components used in surface mounting.

One of the most common causes of failure is directly attributable to bending the printed circuit board after solder attachment. The excessive or sudden movement of the flexible circuit board stresses the inflexible ceramic block causing a crack to appear at the weakest point, usually the ceramic/termination interface. The crack may initially be quite small and not penetrate into the inner electrodes; however, subsequent handling and rapid changes in temperature may cause the crack to enlarge.

This mode of failure is often invisible to normal inspection techniques as the resultant cracks usually lie under the capacitor terminations but if left, can lead to catastrophic failure. More importantly, mechanical cracks, unless they are severe may not be detected by normal electrical testing of the completed circuit, failure only occurring at some later stage after moisture ingress.

The degree of mechanical stress generated on the printed circuit board is dependent upon several factors including the board material and thickness; the amount of solder and land pattern. The amount of solder applied is important, as an excessive amount reduces the chip's resistance to cracking.

It is Knowles's experience that more than 90% are due to board depanelisation, a process where two or more circuit boards are separated after soldering is complete. Other manufacturing stages that should be reviewed include:

- 1) Attaching rigid components such as connectors, relays, display panels, heat sinks etc.
- 2) Fitting conventional leaded components. Special care must be exercised when rigid terminals, as found on large can electrolytic capacitors, are inserted.
- 3) Storage of boards in such a manner which allows warping.
- 4) Automatic test equipment, particularly the type employing "bed of nails" and support pillars.
- 5) Positioning the circuit board in its enclosure especially where this is a "snap-fit".

Knowles were the first MLCC manufacturer to launch a flexible termination to significantly reduce the instances of mechanical cracking. FlexiCap™ termination introduces a certain amount of give into the termination layer absorbing damaging stress. Unlike similar systems, FlexiCap™ does not tear under tension, but absorbs the stress, so maintaining the characteristics of the MLCC.

## SM Pad Design

Knowles conventional 2-terminal chip capacitors can generally be mounted using pad designs in accordance with IPC-7351, Generic Requirements for Surface Mount Design and Land Pattern Standards, but there are some other factors that have been shown to reduce mechanical stress, such as reducing the pad width to

less than the chip width. In addition, the position of the chip on the board should also be considered.

3-Terminal components are not specifically covered by IPC-7351, but recommended pad dimensions are included in the Knowles catalogue / website for these components.

## Alternative Printed Wire Board Land Patterns

Printed Wire Board land pattern design for chip components is critical to ensure a reliable solder fillet, and to reduce nuisance type manufacturing problems such as component swimming and tombstoning. The land pattern suggested can be used for reflow and wave solder operations as noted. Land patterns constructed with these dimensions will yield optimized solder fillet formation and thus reduce the possibility of early failure.<sup>1</sup>

$$A = (\text{Max Length}) + 0.030" (.762\text{mm})^*$$
$$B = (\text{Max Width}) + 0.010" (.254\text{mm})^{**}$$
$$C = (\text{Min Length}) - 2 (\text{Nominal Band})^{***}$$

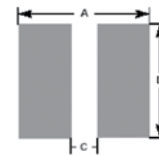

\* Add 0.030" for Wave Solder operations.

\*\* Replace "Max Width" with "Max Thickness" for vertical mounting.

\*\*\* "C" to be no less than 0.02", change "A" to (Max Length) + 0.020".

For C04 "C" to be no less than 0.01".

1. Frances Classon, James Root, Martin Marietta Orlando Aerospace, "Electronics Packaging and Interconnection Handbook".

## MLC Orientation - Horizontal and Vertical Mounting

The orientation of the MLC relative to the ground plane affects the devices' impedance. When the internal electrodes are parallel to the ground plane (Horizontal mounting) the impedance of the MLC resembles a folded transmission line driven from one end.

The graphs below show the modeled insertion loss and parallel resonances of Knowles product C17AH101K-7UN-X0T with horizontal mounting (modeling can be done in CapCad). When the internal electrodes are perpendicular to the ground plane (Vertical mounting, bottom graph) the MLC impedance resembles a folded transmission line driven from the center reducing resonance effects.

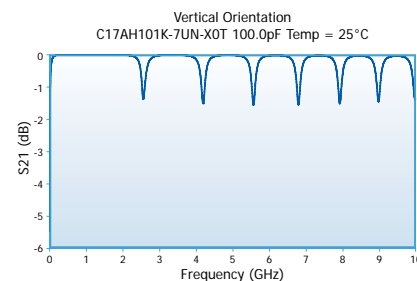
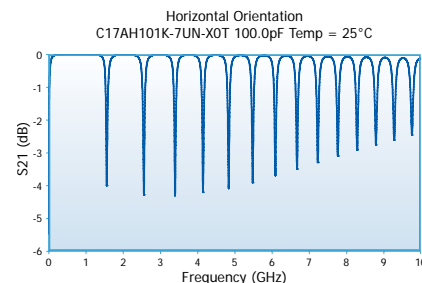

# Mounting, Soldering, Storage & Mechanical Precautions

Knowles MLCCs are compatible with all recognised soldering / mounting methods for chip capacitors.

Specific application notes on mounting and soldering Knowles components are included on the website for each brand.

- For DLI brand components please see DLI application note "Recommended Solder Attachment Techniques for MLC Chip and Pre-Tinned Capacitors" located at: <http://www.knowlescapacitors.com/dilabs/en/gn/resources/application-notes>
- For Syfer brand components, please see Syfer application note AN0028 "Soldering / Mounting Chip Capacitors, Radial Leaded Capacitors and EMI Filters" located at: <http://www.knowlescapacitors.com/syfer/en/gn/technical-info/application-notes>
- For Novacap brand products please refer to the appropriate application note located at: <http://www.knowlescapacitors.com/novacap/en/gn/technical-info/application-notes>

The volume of solder applied to the chip capacitor can influence the reliability of the device. Excessive solder can create thermal and tensile stresses on the component which can lead to fracturing of the chip or the solder joint itself. Insufficient or uneven solder application can result in weak bonds, rotation of the device off line or lifting of one terminal off the pad (tombstoning). The volume of solder is process and board pad size dependent.

Soldering methods commonly used in industry are Reflow Soldering, Wave Soldering and, to a lesser extent, Vapour Phase Soldering. All these methods involve thermal cycling of the components and therefore the rate of heating and cooling must be controlled to preclude thermal shocking of the devices.

Without mechanical restriction, thermally induced stresses are released once the capacitor attains a steady state condition. Capacitors bonded to substrates, however, will retain some stress, due primarily to the mismatch of expansion of the component to the substrate; the residual stress on the chip is also influenced by the ductility and hence the ability of the bonding medium to relieve the stress. Unfortunately, the thermal expansion of chip capacitors differ significantly from those of most substrate materials.

Large chips are more prone to thermal shock as their greater bulk will result in sharper thermal gradients within the device during thermal cycling. Large units experience excessive stress if processed through the fast cycles typical of solder wave or vapour phase operations.

## Reflow soldering Surface Mount Chip Capacitors

Knowles recommend reflow soldering as the preferred method for mounting MLCCs. Knowles MLCCs can be reflow soldered using a reflow profile generally as defined in IPC / JEDEC J-STD-020. Sn plated termination chip capacitors are compatible with both conventional and lead free soldering, with peak temperatures of 260°C to 270°C acceptable.

The heating ramp rate should be such that components see a temperature rise of 1.5°C to 4°C per seconds to maintain temperature uniformity through the MLCC. The time for which the solder is molten should be maintained at a minimum, so as to prevent solder leaching. Extended times above 230°C can cause problems with oxidation of Sn plating. Use of inert atmosphere can help if this problem is encountered. PdAg terminations can be particularly susceptible to leaching with lead free, tin rich solders and trials are recommended for this combination. Cooling to ambient temperature should be allowed to occur naturally, particularly if larger chip sizes are being soldered. Natural cooling allows a gradual relaxation of thermal mismatch stresses in the solder joints. Forced cooling should be avoided as this can induce thermal breakage.

## Wave soldering Surface Mount Chip Capacitors

Wave soldering is generally acceptable, but the thermal stresses caused by the wave have been shown to lead to potential problems with larger or thicker chips. Particular care should be taken when soldering SM chips larger than size 1210 and with a thickness greater than 1.0mm for this reason. 0402 size components are not suitable for wave soldering. 0402 size components can also be susceptible to termination leaching and reflow soldering is recommended for this size MLCC.

Wave soldering exposes the devices to a large solder volume, hence the pad size area must be restricted to accept an amount of solder which is not detrimental to the chip size utilized. Typically the pad width is 66% of the component width, and the length is .030" (.760 mm) longer than the termination band on the chip. An 0805 chip which is .050" wide and has a .020" termination band therefore requires a pad .033" wide by .050" in length. Opposing pads should be identical in size to preclude uneven solder fillets and mismatched surface tension forces which can misalign the device. It is preferred that the pad layout results in alignment of the long axis of the chips at right angles to the solder wave, to promote even wetting of all terminals. Orientation of components in line with the board travel direction may require dual waves with solder turbulence to preclude cold solder joints on the trailing terminals of the devices, as these are blocked from full exposure to the solder by the body of the capacitor.

The pre-heat ramp should be such that the components see a temperature rise of 1.5°C to 4°C per second as for reflow soldering. This is to maintain temperature uniformity through the MLCC and prevent the formation of thermal gradients within the ceramic. The preheat temperature should be within 120°C maximum (100°C preferred) of the maximum solder temperature to minimise thermal shock. Maximum permissible wave temperature is 270°C for SM chips. Total immersion exposure time for Sn/Ni terminations is 30s at a wave temperature of 260°C. Note that for multiple soldering operations, including the rework, the soldering time is cumulative.

The total immersion time in the solder should be kept to a minimum. It is strongly recommended that plated terminations are specified for wave soldering applications. PdAg termination is particularly susceptible to leaching when subjected to lead free wave soldering and is not generally recommended for this application.

Cooling to ambient temperature should be allowed to occur naturally, particularly if larger chip sizes are being soldered. Natural cooling allows a gradual relaxation of thermal mismatch stresses in the solder joints. Forced cooling should be avoided as this can induce thermal breakage.

## Vapour phase soldering Chip Capacitors

Vapour phase soldering can expose capacitors to similar thermal shock and stresses as wave soldering and the advice is generally the same. Particular care should be taken in soldering large capacitors to avoid thermal cracks being induced and natural cooling should be used to allow a gradual relaxation of stresses.

## Hand soldering and rework of Chip Capacitors

Attachment using a soldering iron requires extra care and is accepted to have a risk of cracking of the chip. Precautions include preheating of the assembly to within 100°C of the solder flow temperature and the use of a fine tip iron which does not exceed 30 watts. In no circumstances should the tip of the iron be allowed to contact the chip directly.

Knowles recommend hot air/gas as the preferred method for applying heat for rework. Apply even heat surrounding the component to minimise internal thermal gradients.

Minimise the rework heat duration and allow components to cool naturally after soldering.



# Mounting, Soldering, Storage & Mechanical Precautions

## Wave soldering Radial Leaded Chip Capacitors

Radial leaded capacitors are suitable for wave soldering when mounted on the opposite side of the board to the wave. The body of radial components should not be exposed directly to the wave. Maximum permissible wave temperature is 260°C for Radial Leaded capacitors.

## Hand soldering Radial Leaded capacitors

Radial capacitors can be hand soldered into boards using soldering irons, provided care is taken not to touch the body of the capacitor with the iron tip. Soldering should be carried out from the opposite side of the board to the radial to minimise the risk of damage to the capacitor body. Where possible, a heat sink should be used between the solder joint and the body, especially if longer dwell times are required.

## Solder leaching

Leaching is the term for the dissolution of silver into the solder causing a failure of the termination system which causes increased ESR,  $\tan \delta$  and open circuit faults, including ultimately the possibility of the chip becoming detached. Leaching occurs more readily with higher temperature solders and solders with a high tin content. Pb free solders can be very prone to leaching certain termination systems. To prevent leaching, exercise care when choosing solder alloys and minimize both maximum temperature and dwell time with the solder molten.

Plated terminations with nickel or copper anti leaching barrier layers are available in a range of top coat finishes to prevent leaching occurring. These finishes also include Syfer FlexiCap™ for improved stress resistance post soldering.

## Bonding

Hybrid assembly using conductive epoxy or wire bonding requires the use of silver palladium or gold terminations. Nickel barrier termination is not practical in these applications, as intermetallics will form between the dissimilar metals. The ESR will increase over time and may eventually break contact when exposed to temperature cycling.

## Cleaning

Chip capacitors can withstand common agents such as water, alcohol and degreaser solvents used for cleaning boards. Ascertain that no flux residues are left on the chip surfaces as these diminish electrical performance.

## Handling

Ceramics are dense, hard, brittle and abrasive materials. They are liable to suffer mechanical damage, in the form of chips or cracks, if improperly handled.

Terminations may be abraded onto chip surfaces if loose chips are tumbled in bulk. Metallic tracks may be left on the chip surfaces which might pose a reliability hazard.

Components should never be handled with fingers; perspiration and skin oils can inhibit solderability and will aggravate cleaning.

Chip capacitors should never be handled with metallic instruments. Metal tweezers should never be used as these can chip the product and may leave abraded metal tracks on the product surface. Plastic or plastic coated metal types are readily available and recommended - these should be used with an absolute minimum of applied pressure.

Counting or visual inspection of chip capacitors is best performed on a clean glass or hard plastic surface.

If chips are dropped or subjected to rough handling, they should be visually inspected before use. Electrical inspection may also reveal gross damage via a change in capacitance, an increase in dissipation factor or a decrease either in insulation resistance or electrical strength.

## Transportation

Where possible, any transportation should be carried out with the product in its unopened original packaging. If already opened, any environmental control agents supplied should be returned to packaging and the packaging re-sealed.

Avoid paper and card as a primary means of handling, packing, transportation and storage of loose components. Many grades have a sulphur content which will adversely affect termination solderability.

Loose chips should always be packed with sulphur-free wadding to prevent impact or abrasion damage during transportation.

## Storage

Incorrect storage of components can lead to problems for the user. Rapid tarnishing of the terminations, with an associated degradation of solderability, will occur if the product comes into contact with industrial gases such as sulphur dioxide and chlorine. Storage in free air, particularly moist or polluted air, can result in termination oxidation.

Packaging should not be opened until the MLCs are required for use. If opened, the pack should be re-sealed as soon as is practicable. Alternatively, the contents could be kept in a sealed container with an environmental control agent.

Long term storage conditions, ideally, should be temperature controlled between -5 and +40°C and humidity controlled between 40 and 60% R.H.

Taped product should be stored out of direct sunlight, which might promote deterioration in tape or adhesive performance.

Product, stored under the conditions recommended above, in its "as received" packaging, has a minimum shelf life of 2 years.

# Chip Marking System

If required, we can mark capacitors with the EIA 198 two digit code to show the capacitance value of the part. On chips larger than 3333, or for leaded encapsulated devices, ink marking is available. However, for chip sizes 0805 through to 3333 identification marking is accomplished by using either laser or ink jet printer. This system does not degrade the ceramic surface, or induce microcracks in the part.

Marking for other sizes may be available upon special request to determine if applicable; please contact the sales office.

Marking is an option on Novacap and Syfer branded products and needs to be specified when ordering.



Two position alpha numeric marking is available on chip sizes 0805 through 3333. The marking denotes retma value and significant figures of capacitance (see table) eg: A5 = 100,000pF.

Three position alpha numeric marking is available on chip sizes 1206 and larger. The making denotes Novacap as vendor (N), followed by the standard two digit alpha numeric identification.

## Marking Code - value in picofarads for alpha-numeric code

Number	0	1	2	3	4	5	6	7	9	
Letter	A	1.0	10	100	1,000	10,000	100,000	1,000,000	10,000,000	0.1
	B	1.1	11	110	1,100	11,000	110,000	1,100,000	11,000,000	0.11
	C	1.2	12	120	1,200	12,000	120,000	1,200,000	12,000,000	0.12
	D	1.3	13	130	1,300	13,000	130,000	1,300,000	13,000,000	0.13
	E	1.5	15	150	1,500	15,000	150,000	1,500,000	15,000,000	0.15
	F	1.6	16	160	1,600	16,000	160,000	1,600,000	16,000,000	0.16
	G	1.8	18	180	1,800	18,000	180,000	1,800,000	18,000,000	0.18
	H	2.0	20	200	2,000	20,000	200,000	2,000,000	20,000,000	0.2
	J	2.2	22	220	2,200	22,000	220,000	2,200,000	22,000,000	0.22
	K	2.4	24	240	2,400	24,000	240,000	2,400,000	24,000,000	0.24
	L	2.7	27	270	2,700	27,000	270,000	2,700,000	27,000,000	0.27
	M	3.0	30	300	3,000	30,000	300,000	3,000,000	30,000,000	0.3
	N	3.3	33	330	3,300	33,000	330,000	3,000,000	33,000,000	0.33
	P	3.6	36	360	3,600	36,000	360,000	3,600,000	36,000,000	0.36
	Q	3.9	39	390	3,900	39,000	390,000	3,900,000	39,000,000	0.39
	R	4.3	43	430	4,300	43,000	430,000	4,300,000	43,000,000	0.43
	S	4.7	47	470	4,700	47,000	470,000	4,700,000	47,000,000	0.47
	T	5.1	51	510	5,100	51,000	510,000	5,100,000	51,000,000	0.51
	U	5.6	56	560	5,600	56,000	560,000	5,600,000	56,000,000	0.56
	V	6.2	62	620	6,200	62,000	620,000	6,200,000	62,000,000	0.62
	W	6.8	68	680	6,800	68,000	680,000	6,800,000	68,000,000	0.68
	X	7.5	75	750	7,500	75,000	750,000	7,500,000	75,000,000	0.75
	Y	8.2	82	820	8,200	82,000	820,000	8,200,000	82,000,000	0.82
	Z	9.1	91	910	9,100	91,000	920,000	9,200,000	92,000,000	0.91
	a	2.5	25	250	2,500	25,000	250,000	2,500,000	25,000,000	0.25
	b	3.5	35	350	3,500	35,000	350,000	3,500,000	35,000,000	0.35
d	4.0	40	400	4,000	40,000	400,000	4,000,000	40,000,000	0.4	
e	4.5	45	450	4,500	45,000	450,000	4,500,000	45,000,000	0.45	
f	5.0	50	500	5,000	50,000	500,000	5,000,000	50,000,000	0.5	
m	6.0	60	600	6,000	60,000	600,000	6,000,000	60,000,000	0.6	
n	7.0	70	700	7,000	70,000	700,000	7,000,000	70,000,000	0.7	
t	8.0	80	800	8,000	80,000	800,000	8,000,000	80,000,000	0.8	
y	9.0	90	900	9,000	90,000	900,000	9,000,000	90,000,000	0.9	

# Ceramic Chip Capacitors - Packaging information

Tape and reel packing of surface mounting chip capacitors for automatic placement are in accordance with IEC60286-3.

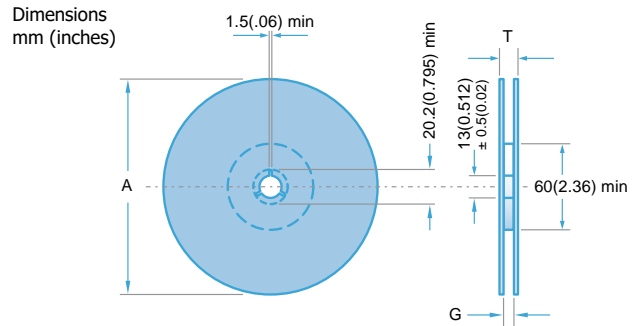
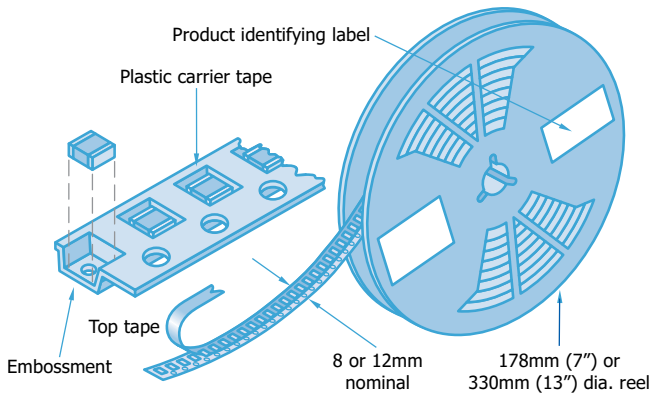

Symbol	Description	178mm reel	330mm reel
A	Diameter	178 (7)	330 (13)
G	Inside width	8.4 (0.33)	12.4 (0.49)
T	Outside width	14.4 (0.56) max	18.4 (0.72) max

## Peel force

The peel force of the top sealing tape is between 0.2 and 1.0 Newton at 180°. The breaking force of the carrier and sealing tape in the direction of unreeling is greater than 10 Newtons.

## Identification

Each reel is labelled with the following information: manufacturer, chip size, capacitance, tolerance, rated voltage, dielectric type, batch number, date code and quantity of components.

## Missing components

Maximum number of missing components shall be 1 per reel or 0.025% whichever is greater. There shall not be consecutive components missing from any reel for any reason.

## Tape dimensions

## Leader and Trailer

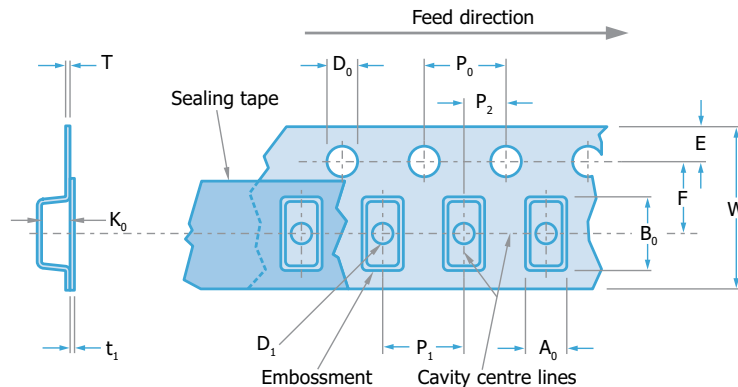
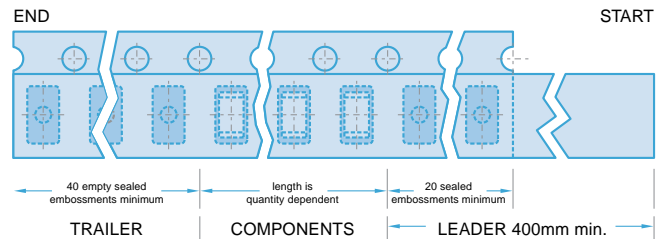

Symbol	Description	Dimensions mm (inches)	
		8mm tape	12mm tape
A <sub>0</sub>	Width of cavity	Dependent on chip size to minimize rotation	
B <sub>0</sub>	Length of cavity		
K <sub>0</sub>	Depth of cavity		
W	Width of tape	8.0 (0.315)	12.0 (0.472)
F	Distance between drive hole centres and cavity centres	3.5 (0.138)	5.5 (0.213)
E	Distance between drive hole centres and tape edge	1.75 (0.069)	
P <sub>1</sub>	Distance between cavity centres	4.0 (0.156)	8.0 (0.315)
P <sub>2</sub>	Axial distance between drive hole centres and cavity centres	2.0 (0.079)	
P <sub>0</sub>	Axial distance between drive hole centres	4.0 (0.156)	
D <sub>0</sub>	Drive hole diameter	1.5 (0.059)	
D <sub>1</sub>	Diameter of cavity piercing	1.0 (0.039)	1.5 (0.059)
T	Carrier tape thickness	0.3 (0.012) ±0.1 (0.004)	0.4 (0.016) ±0.1 (0.004)
t <sub>1</sub>	Top tape thickness	0.1 (0.004) max	

# Ceramic Chip Capacitors - Packaging information

## Component orientation

Tape and reeling is in accordance with IEC 60286 part 3, which defines the packaging specifications of lead less components on continuous tapes.

- Notes: 1) IEC60286-3 states  $A_o \leq B_o$  (see tape dimensions on page 18).  
 2) Regarding the orientation of 1825 and 2225 components, the termination bands are right to left, NOT front to back. Please see diagram.

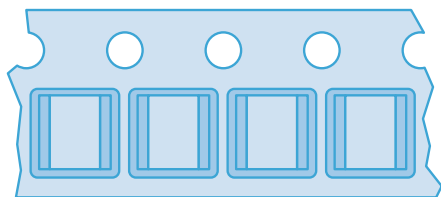

Orientation of 1825 & 2225 components

## Outer Packaging

Outer carton dimensions mm (inches) max.

Reel Size	No. of reels	L	W	T
178 (7.0)	1	185 (7.28)	185 (7.28)	25 (0.98)
178 (7.0)	4	190 (7.48)	195 (7.76)	75 (2.95)
330 (13.0)	1	335 (13.19)	335 (13.19)	25 (0.98)

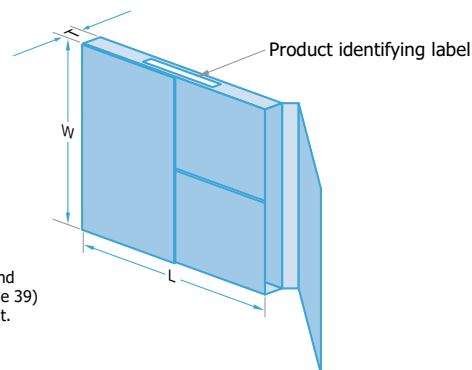

Note: Labelling of box and reel with bar codes (Code 39) available by arrangement.



## Reel quantities - Novacap, Syfer and Voltronics products

Chip size	0402	0505	0603	0805	1111	1206	1210	1410	1515	1808	1812	1825	2211	2215	2220	2221	2225	2520	3333	3530	3640	4540	5550	6560	7565	
<b>Max. chip thickness</b>																										
mm	0.61	1.3	0.89	1.37	1.8	1.63	2.0	2.0	3.3	2.0	3.2	4.2	2.5	2.5	4.2	2.0	4.2	4.57	6.35	6.35	4.2	7.62	7.62	7.62	7.62	
inches	0.02"	0.05"	0.03"	0.05"	0.07"	0.06"	0.08"	0.08"	0.13"	0.08"	0.13"	0.165"	0.1"	0.1"	0.165"	0.08"	0.165"	0.18"	0.25"	0.25"	0.165"	0.3"	0.3"	0.3"	0.3"	
<b>Reel quantities</b>																										
178mm (7")	10k	2500	4000	3000	1000	2500	2000	2000	500	1500	500	500	750	500	500	1000	500	1000	-	-	-	-	-	-	-	
330mm (13")	15k	10k	16k	12k	5000	10k	8000	8000	-	6000	2000	2000	4000	2000	2000	-	2000	1000	1000	500	500	500	500	500	200	

## Packaging configurations - DLI products

Chip size	Style	L x W	7" Reel, 8mm Tape		7" Reel, 16mm Tape	13" Reel, 16mm Tape	2" x 2" Waffle Pack
			Horizontal Orientation	Vertical Orientation	Horizontal Orientation	Horizontal Orientation	
C04		0.040" x 0.020"	4000	-	-	-	-
C06		0.060" x 0.030"	4000	-	-	-	108
C07		0.110" x 0.070"	2000	-	-	-	-
C08		0.080" x 0.050"	5000	3100	-	-	108
C11		0.055" x 0.055"	3500	3100	-	-	108
C17		0.110" x 0.110"	2350	750	-	-	49
C18		0.110" x 0.110"	2350	750	-	-	49
C22		0.220" x 0.245"	500	-	-	-	-
C40		0.380" x 0.380"	250	-	250	1300	-

## Bulk packaging, tubs

Chips can be supplied in rigid re-sealable plastic tubs together with impact cushioning wadding. Tubs are labelled with the details: chip size, capacitance, tolerance, rated voltage, dielectric type, batch number, date code and quantity of components.

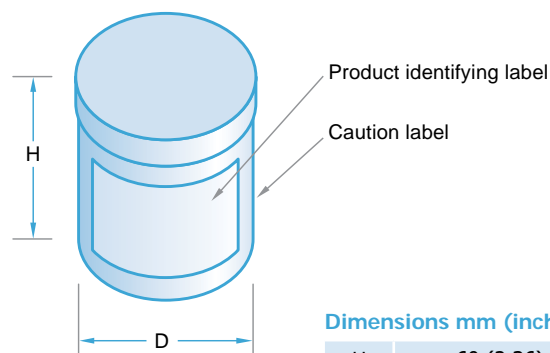

Dimensions mm (inches)

H	60 (2.36)
D	50 (1.97)

# Chip dimensions

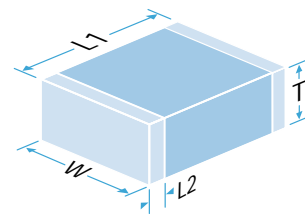

1. For FlexiCap™ terminations, length increase by maximum 0.004" (0.1mm).
2. For special ranges, inc. High Q and Ultra-low ESR, dimensions may vary. See individual catalogue page.
3. High Q and Ultra-low ESR ranges dimensions may vary for optimum performance.
4. Non-standard thicknesses are available – consult local Knowles Capacitors Sales Office.

Size	Length (L1)	Width (w)	Max. Thickness (T)	Termination Band (L2)	
	mm ~ inches	mm ~ inches	mm ~ inches	min (mm ~ inches)	max (mm ~ inches)
0402	1.0 ± 0.10 ~ 0.04 ± 0.004	0.50 ± 0.10 ~ 0.02 ± 0.004	0.60 ~ 0.024	0.10 ~ 0.004	0.40 ~ 0.016
C04	1.057 ± 0.188 ~ 0.042 ± 0.008	0.515 ± 0.153 ~ 0.02 ± 0.006	0.64 ~ 0.025	0.097 ~ 0.004	0.427 ~ 0.017
0504	1.27 ± 0.152 ~ 0.050 ± 0.006	1.02 ± 0.152 ~ 0.04 ± 0.006	1.12 ~ 0.044	0.20 ~ 0.008	0.50 ~ 0.02
0505	1.4 +0.35 -0.25 ~ 0.055 +0.014 -0.01	1.4 ± 0.25 ~ 0.055 ± 0.01	1.27 ~ 0.05	0.13 ~ 0.005	0.5 ~ 0.02
RF0505	1.4 ± 0.13 ~ 0.055 ± 0.005	1.4 ± 0.381 ~ 0.055 ± 0.015	1.45 ~ 0.057	0.20 ~ 0.008	0.50 ~ 0.02
C11	1.477 ± 0.391 ~ 0.059 ± 0.016	1.416 ± 0.451 ~ 0.056 ± 0.018	1.334 ~ 0.053	0.193 ~ 0.008	0.733 ~ 0.029
0603	1.6 ± 0.15 ~ 0.063 ± 0.006	0.8 ± 0.15 ~ 0.032 ± 0.006	0.90 ~ 0.036	0.20 ~ 0.004	0.40 ~ 0.016
C06	1.532 ± 0.229 ~ 0.06 ± 0.009	0.77 ± 0.191 ~ 0.031 ± 0.008	0.8 ~ 0.032	0.169 ~ 0.007	0.680 ~ 0.027
C07	1.797 ± 0.470 ~ 0.071 ± 0.019	2.813 ± 0.521 ~ 0.111 ± 0.021	2.667 ~ 0.105	0.193 ~ 0.008	1.20 ~ 0.047
0805	2.0 ± 0.20 ~ 0.079 ± 0.008	1.25 ± 0.20 ~ 0.049 ± 0.008	1.37 ~ 0.054	0.25 ~ 0.010	0.75 ~ 0.030
C08	2.048 ± 0.407 ~ 0.081 ± 0.016	1.28 ± 0.267 ~ 0.051 ± 0.011	1.360 ~ 0.054	0.362 ~ 0.014	1.04 ~ 0.041
0907	2.3 ± 0.30 ~ 0.090 ± 0.012	1.8 ± 0.30 ~ 0.070 ± 0.012	1.52 ~ 0.06	0.25 ~ 0.010	0.75 ~ 0.030
1005	2.54 ± 0.203 ~ 0.100 ± 0.008	1.27 ± 0.203 ~ 0.050 ± 0.008	1.37 ~ 0.054	0.25 ~ 0.010	0.75 ~ 0.030
1111	2.79 +0.51 -0.25 ~ 0.11 +0.02 -0.01	2.79 ± 0.38 ~ 0.113 ± 0.015	1.78 ~ 0.07	0.13 ~ 0.005	0.63 ~ 0.025
RF1111	2.79 ± 0.39 ~ 0.110 ± 0.005	2.79 ± 0.381 ~ 0.110 ± 0.015	2.59 ~ 0.102	0.25 ~ 0.010	0.75 ~ 0.030
C17	2.94 ± 0.527 ~ 0.116 ± 0.021	2.813 ± 0.521 ~ 0.111 ± 0.021	2.667 ~ 0.105	0.193 ~ 0.008	1.2 ~ 0.047
C18	3.14 ± 0.727 ~ 0.124 ± 0.029	2.946 ± 0.654 ~ 0.116 ± 0.026	2.667 ~ 0.105	0.193 ~ 0.008	1.2 ~ 0.047
1206	3.2 ± 0.20 ~ 0.126 ± 0.008	1.6 ± 0.20 ~ 0.063 ± 0.008	1.70 ~ 0.068	0.25 ~ 0.010	0.75 ~ 0.030
1210	3.2 ± 0.20 ~ 0.126 ± 0.008	2.5 ± 0.20 ~ 0.098 ± 0.008	2.0 ~ 0.08	0.25 ~ 0.010	0.75 ~ 0.030
1515	3.81 ± 0.381 ~ 0.150 ± 0.015	3.81 ± 0.381 ~ 0.150 ± 0.015	3.3 ~ 0.13	0.381 ~ 0.015	1.143 ~ 0.045
1808	4.5 ± 0.35 ~ 0.180 ± 0.014	2.0 ± 0.30 ~ 0.08 ± 0.012	2.0 ~ 0.08	0.25 ~ 0.01	1.0 ~ 0.04
1812	4.5 ± 0.30 ~ 0.180 ± 0.012	3.2 ± 0.20 ~ 0.126 ± 0.008	3.2 ~ 0.125	0.25 ~ 0.010	1.143 ~ 0.045
1825	4.5 ± 0.30 ~ 0.180 ± 0.012	6.40 ± 0.40 ~ 0.252 ± 0.016	4.2 ~ 0.16	0.25 ~ 0.010	1.0 ~ 0.04
2020	5.0 ± 0.40 ~ 0.197 ± 0.016	5.0 ± 0.40 ~ 0.197 ± 0.016	4.5 ~ 0.18	0.25 ~ 0.01	1.0 ~ 0.04
2220	5.7 ± 0.40 ~ 0.225 ± 0.016	5.0 ± 0.40 ~ 0.197 ± 0.016	4.2 ~ 0.165	0.25 ~ 0.01	1.0 ~ 0.04
2211	5.7 ± 0.40 ~ 0.225 ± 0.016	2.79 ± 0.30 ~ 0.11 ± 0.012	2.5 ~ 0.1	0.25 ~ 0.01	0.8 ~ 0.03
2215	5.7 ± 0.40 ~ 0.225 ± 0.016	3.81 ± 0.35 ~ 0.35 ± 0.02	2.5 ~ 0.1	0.25 ~ 0.01	0.8 ~ 0.03
2221	5.59 ± 0.381 ~ 0.220 ± 0.015	5.33 ± 0.381 ~ 0.210 ± 0.015	2.03 ~ 0.08	0.381 ~ 0.015	1.143 ~ 0.045
2225	5.7 ± 0.40 ~ 0.225 ± 0.016	6.30 ± 0.40 ~ 0.252 ± 0.016	4.2 ~ 0.165	0.381 ~ 0.01	1.143 ~ 0.045
C22	5.734 ± 0.667 ~ 0.226 ± 0.026	6.37 ± 0.699 ~ 0.251 ± 0.028	3.467 ~ 0.137	N/A	N/A
2520	6.35 ± 0.40 ~ 0.250 ± 0.016	5.08 ± 0.40 ~ 0.200 ± 0.016	4.57 ~ 0.18	0.381 ~ 0.015	1.143 ~ 0.045
RF2525	5.84 ± 0.21 ~ 0.230 ± 0.008	6.35 ± 0.381 ~ 0.250 ± 0.015	4.19 ~ 0.165	0.381 ~ 0.015	1.143 ~ 0.045
3333	8.38 ± 0.432 ~ 0.330 ± 0.017	8.38 ± 0.432 ~ 0.330 ± 0.017	6.35 ~ 0.25	0.381 ~ 0.015	1.143 ~ 0.045
3530	8.89 ± 0.457 ~ 0.350 ± 0.018	7.62 ± 0.381 ~ 0.300 ± 0.015	6.35 ~ 0.25	0.381 ~ 0.015	1.143 ~ 0.045
3640	9.2 ± 0.50 ~ 0.36 ± 0.02	10.16 ± 0.50 ~ 0.40 ± 0.02	4.5 ~ 0.18	0.50 ~ 0.02	1.50 ~ 0.06
C40	9.732 ± 0.804 ~ 0.384 ± 0.032	8.665 ± 1.737 ~ 0.381 ± 0.029	3.467 ~ 0.137	N/A	N/A
4040	10.2 ± 0.508 ~ 0.400 ± 0.020	10.2 ± 0.508 ~ 0.400 ± 0.020	7.62 ~ 0.30	0.50 ~ 0.02	1.50 ~ 0.06
4540	11.4 ± 0.584 ~ 0.450 ± 0.023	10.2 ± 0.508 ~ 0.400 ± 0.020	7.62 ~ 0.30	0.50 ~ 0.02	1.50 ~ 0.06
5440	13.7 ± 0.686 ~ 0.540 ± 0.027	10.2 ± 0.508 ~ 0.400 ± 0.020	7.62 ~ 0.30	0.50 ~ 0.02	1.50 ~ 0.06
5550	14.0 ± 0.711 ~ 0.550 ± 0.028	12.7 ± 0.635 ~ 0.500 ± 0.025	7.62 ~ 0.30	0.50 ~ 0.02	1.50 ~ 0.06
6560	16.5 ± 0.838 ~ 0.650 ± 0.033	15.2 ± 0.762 ~ 0.600 ± 0.030	7.62 ~ 0.30	0.50 ~ 0.02	1.50 ~ 0.06
7565	19.1 ± 0.965 ~ 0.750 ± 0.038	16.5 ± 0.838 ~ 0.650 ± 0.033	7.62 ~ 0.30	0.50 ~ 0.02	1.50 ~ 0.06
8060	20.3 ± 0.5 ~ 0.80 ± 0.02	15.24 ± 0.50 ~ 0.60 ± 0.02	4.2 ~ 0.165	0.50 ~ 0.02	1.50 ~ 0.06



# Chip ordering information - DLI parts

C	17	CF	620	J	-	7	U	N	-	X	O	T
MLC Capacitor	Case Size	Dielectric	Capacitance Codes	Capacitance Tolerance		Rated voltage	Termination	Lead Type		Test Level	Marking	Packaging

## Case Size

Case	Dimensions
04	0.040" x 0.020"
06	0.060" x 0.030"
07	0.110" x 0.070"
08	0.080" x 0.050"
11	0.055" x 0.055"
17	0.110" x 0.110"
18	0.110" x 0.110"
22	0.220" x 0.250"
40	0.380" x 0.380"

## Dielectric Codes

Material	Characteristics
AH	P90 High-Q
CF	NPO High-Q

## Capacitance Codes

1 <sup>st</sup> two digits are significant figures of capacitance, 3 <sup>rd</sup> digit denotes number of zeros, R = decimal point Examples:	1R0	1.0pF
	120	12pF
	471	470pF
	102	1,000pF

## Voltage Codes

Code	Value
5	50V
1	100V
8	150V
6	200V
9	250V
3	300V
4	500V
7	1kV
A	1.5kV
G	2kV
B	2.5kV
D	3.6kV
H	7.2kV
S	SPECIAL

## Capacitance Tolerance

Code	Value
A	± 0.05pF
B	± 0.1pF
C	± 0.25pF
D	± 0.5pF
F	± 1%
G	± 2%
J	± 5%
K	± 10%
M	± 20%
X	GMV
S	SPECIAL

<10pF A, B, C, D  
>10pF F, G, J, K, M

## Termination Codes

Code	Termination System
T	Ag Termination, Ni Barrier Layer, Heavy SnPb Plated Solder
U	Ag Termination, Ni Barrier Layer, SnPb Plated Solder
S	Ag Termination, Ni Barrier Layer, Gold Flash*
Z	Ag Termination, Ni Barrier Layer, Sn Plated Solder*
E	Ag Termination, Enhanced Ni Barrier, Sn Plated Solder*
P**	AgPd Termination*
Q	Polymer Termination, Ni Barrier Layer, Sn Plated Solder*
Y	Polymer Termination, Ni Barrier Layer, SnPb Plated Solder
M**	Polymer Termination, Cu Barrier Layer, Sn Plated Solder*
W**	Ag Termination, Cu Barrier Layer, Sn Plated Solder*
H**	Ag Termination, Enhanced Cu Barrier, Sn Plated Solder*
V**	Ag Termination, Cu Barrier Layer, SnPb Plated Solder
R**	Ag Termination, Cu Barrier Layer, Heavy SnPb Plated Solder

\*\* Nonmagnetic \*Indicates RoHS terminations

## Test Level

Code	Testing
X	Commercial or Industrial
Y	Reduced Visual
A	MIL-PRF-55681 Group A
C	MIL-PRF-55681 Group C
D	Customer Specified

## Laser Mark

Code	Laser Marking
0	No marking
1*	Single-side marked
2*	Double-side marked
3*	Large single-side marked
4*	Large double-side marked
5*	Vertical edge marked
9	Customer Specified

\*Reduces DWV Rating.

## Packaging





Code	Packaging
T	Tape & Reel – Horizontal
V	Tape & Reel – Vertical
W	Waffle Pack
B	Bulk
P	Plastic Box
R	Tube (Rail)
S	Customer Specified

## Leading

Code	Lead Type
A	Axial Ribbon
B	Radial Ribbon
C	Center Ribbon
D	Specialty Customer Defined
E	Axial Wire
F	Radial Wire
N	NONE

Note: Consult your local Sales Office for RoHS compliant leaded devices.

**Lead Termination Codes** Leads are attached with high melting point solder (HMP) at 296°C.

Axial Ribbon - Code A	Radial Ribbon - Code B	Center Ribbon - Code C	Axial Wire Lead - Code E	Radial Wire Lead - Code F
				

# Chip ordering information - Novacap parts

XX	1206	N	472	J	101	N	X050	H	T	M	HB
Prefix	Case Size	Dielectric	Capacitance Codes	Capacitance Tolerance	Voltage	Termination	Special Thickness	High Reliability Testing	Packaging	Marking	High Reliability Test Criteria

## Prefix Definitions

None	Standard chip	
RF	Improved ESR Capacitor	p. 39
ST	Stacked Capacitor Assembly	p. 76 - 81
SM	Stacked Hi-Rel Capacitor Assembly	p. 76 - 81
CR	Cap Rack Arrays	p. 82

## Dielectric Codes

N	COG/NP0	Ultra Stable
K	R3L	Ultra Stable
B	X7R	Stable
W	X5R	Stable
X	BX	MIL
BB	X7R	Stable BME
BW	X5R	Stable BME
M	COG/NP0	Non Magnetic
C	X7R	Non Magnetic
F	COG/NP0	High Temp. (up to 160°C)
D, RD	COG/NP0	High Temp. (up to 200°C)
S	X8R	High Temp. (up to 150°C)
E, RE	Class II	High Temp. (up to 200°C)
G	Class II	High Temp. (up to 160°C)
RN	COG/NP0	Lead free
RB	X7R	Lead free

## Capacitance Codes

1 <sup>st</sup> two digits are significant figures of capacitance, 3 <sup>rd</sup> digit denotes number of zeros, R = decimal point Examples:	1R0	1.0pF
	120	12pF
	471	470pF
	102	1,000pF
	273	0.027μF
	474	0.47μF
	105	1.0μF

## Capacitance Tolerance Codes

Code	Tolerance	COG/NP0		R3L	X7R	BX	X8R	Class II	X5R	
		N	M	F/D, RD	K	B	C, RE	X	S	E/G
B	±0.10pF	•	•							
C	±0.25pF	•	•		•					
D	±0.50pF	•	•		•					
F	±1%	•	•	•						
G	±2%	•	•	•	•					
J	±5%	•	•	•	•	•*	•	•*	•	•
K	±10%	•	•	•	•	•	•	•	•	•
M	±20%	•	•	•	•	•	•	•	•	•

## Special Thickness

None	Standard thickness as per Novacap catalog specifications
X	Denotes a special thickness other than standard. Specify in inches if required. (As shown above X = 0.050")

## High Reliability Testing

None	Standard product
H	High Reliability Testing
H	High Temp Screening

## Voltage Code

1st two digits are significant, third digit denotes number of zeros. For example:

160	16 Volts
101	100 Volts
501	500 Volts
102	1,000 Volts
502	5,000 Volts
103	10,000 Volts

## Termination Codes

P	Palladium Silver	
PR	Palladium Silver*	
K	Solderable Palladium Silver*	
N	Nickel Barrier*	100% tin
Y	Nickel Barrier	90% tin, 10% lead
NG	Nickel Barrier Gold Flash*	
C	FlexiCap™/Nickel Barrier*	100% tin
D	FlexiCap™/Nickel Barrier	90% tin, 10% lead
B	Copper Barrier*	100% tin
E	Copper Barrier	90% tin, 10% lead
S	Silver*	

\*Indicates RoHS terminations

## Marking

None	Unmarked
M	Marked *Marking not available on sizes ≤ 0603

Note: Refer to page 17.

## Packaging

None	Bulk
T	Tape and Reel
W	Waffle Pack

## High Reliability Testing Criteria

HB	MIL-PRF-55681 Group A
HV	MIL-PRF-49467 Group A
HS	MIL-PRF-123 Group A
HK	MIL-PRF-38534 Class K

# Chip ordering information - Syfer parts

<b>1210</b>	<b>Y</b>	<b>100</b>	<b>0103</b>	<b>K</b>	<b>X</b>	<b>T</b>	<b>---</b>
Chip Size	Termination	Voltage	Capacitance in picofarads (pF)	Capacitance Tolerance	Dielectric	Packaging	Suffix code

## Case Code

0402
0603
0805
1206
1210
1808
1812
1825
2220
2225
3640
5550
8060

## Termination Codes

<b>A</b>	Nickel barrier	90/10% tin/lead
<b>F</b>	Palladium Silver*	
<b>H</b>	FlexiCap™/Nickel Barrier	90/10% tin/lead
<b>J</b>	Nickel Barrier*	100% tin
<b>Y</b>	FlexiCap™/Nickel Barrier*	100% tin
<b>2</b>	Copper Barrier* (Non Mag)	100% tin
<b>3</b>	FlexiCap™/Copper Barrier* (Non Mag)	100% tin
<b>4</b>	Copper Barrier (Non Mag)	90/10% tin/lead
<b>5</b>	FlexiCap™/Copper Barrier (Non Mag)	90/10% tin/lead

\*Indicates RoHS terminations

## Voltage Code

Code	Value	Code	Value	Code	Value
<b>010</b>	10Vdc	<b>1K0</b>	1kVdc	<b>A25</b>	250Vac
<b>016</b>	16Vdc	<b>1K2</b>	1.2kVdc		
<b>025</b>	25Vdc	<b>1K5</b>	1.5kVdc		
<b>050</b>	50Vdc	<b>2K0</b>	2kVdc		
<b>063</b>	63Vdc	<b>2K5</b>	2.5kVdc		
<b>100</b>	100Vdc	<b>3K0</b>	3kVdc		
<b>200</b>	200Vdc	<b>4K0</b>	4kVdc		
<b>250</b>	250Vdc	<b>5K0</b>	5kVdc		
<b>500</b>	500Vdc	<b>6K0</b>	6kVdc		
<b>630</b>	630Vdc	<b>8K0</b>	8kVdc		
		<b>10K</b>	10kVdc		
		<b>12K</b>	12kVdc		

## Capacitance Tolerance Codes

Code	Tolerance	
<b>H</b>	±0.05pF	< 4.7pF
<b>H</b>	±0.05pF	Cap. Value < 10pF
<b>B</b>	±0.10pF	
<b>C</b>	±0.25pF	
<b>D</b>	±0.50pF	Cap. Value ≥ 10pF
<b>F</b>	±1%	
<b>G</b>	±2%	
<b>J</b>	±5%	
<b>K</b>	±10%	
<b>M</b>	±20%	

## Packaging

Code	
<b>T</b>	178mm (7") reel
<b>R</b>	330mm (13") reel
<b>B</b>	Bulk pack - tubs or trays

## Suffix Definitions

Used for specific customer requirements

<b>PXX</b>	Palladium electrodes
<b>LS*</b>	Chip marking *(consult sales office)

## Dielectric Codes

Code	Dielectric	Features
<b>C</b>	COG/NP0 (1B)	Ultra Stable
<b>H</b>	X8G	Ultra Stable/High Q
<b>P</b>	X5R	Stable
<b>X</b>	X7R (2R1)	Stable
<b>J</b>	X7R (2R1)(BME)	Stable
<b>N</b>	X8R	Stable
<b>Q</b>	COG/NP0 (1B)	Ultra Stable/High Q
<b>U</b>	COG/NP0 (1B)	Ultra Stable/Ultra-low ESR
<b>A</b>	COG/NP0 (1B)	AEC -Q200 approved
<b>S</b>	X7R (2R1)(BME)	AEC -Q200 approved
<b>E</b>	X7R (2R1)	AEC -Q200 approved
<b>T</b>	X8R	AEC -Q200 approved
<b>K</b>	COG/NP0 (1B)(BME)	AEC -Q200 approved
<b>F</b>	COG/NP0 (1B)	IECQ-CECC release
<b>D</b>	X7R (2R1)	IECQ-CECC release
<b>R</b>	BZ (2C1)	IECQ-CECC release
<b>B</b>	BX (2X1)	IECQ-CECC release
<b>G</b>	COG/NP0 (1B)(BME)	Ultra Stable

## Capacitance Code

Calculation	Example	Capacitance value
<1.0pF Insert a P for the decimal point as the 1 <sup>st</sup> character.	<b>P300</b>	0.3pF (values in 0.1pF steps)
≥1.0pF & <10pF Insert a P for the decimal point as the 2 <sup>nd</sup> character.	<b>8P20</b>	8.2pF (values are E24 series)
≥10pF 1 <sup>st</sup> digit is 0. 2 <sup>nd</sup> and 3 <sup>rd</sup> digits are significant figures of capacitance value. 4 <sup>th</sup> digit is number of zeros.	<b>0101</b>	100pF (values are E24 series)

# MLCC standard range - 10V to 12kVdc



	10V		16V			25V			50/63V			100V		200/250V		500V		630V		1kV				
	COG/NPO	X5R	COG/NPO	X7R	X5R	COG/NPO	X7R	X5R	COG/NPO	X7R	X5R	COG/NPO	X7R	COG/NPO	X7R	COG/NPO	X7R	COG/NPO	X7R	COG/NPO	X7R			
<b>0402</b>	—	—	0.3p - 270p	120p - 5.6n	—	0.3p - 220p	120p - 4.7n	—	0.3p - 180p	120p - 4.7n	—	0.3p - 180p	120p - 4.7n	0.3p - 100p	120p - 2.2n	—	—	—	—	—	—			
<b>0603</b>	0.47p - 3.9n	120n - 150n	0.47p - 2.7n	100p - 100n	120n	0.47p - 2.2n	100p - 100n	—	0.47p - 1.5n	100p - 100n	56n - 68n	0.47p - 470p	100p - 47n	0.47p - 220p	100p - 10n	0.47p - 150p*	100p - 1.5n*	—	—	—	—			
<b>0805</b>	1.0p - 15n	390n - 680n	1.0p - 12n	100p - 330n	390n - 470n	1.0p - 10n	100p - 220n	270n - 390n	1.0p - 5.6n	100p - 220n	270n - 330n	1.0p - 2.2n	100p - 100n	1.0p - 1.0n	100p - 56n	1.0p - 820p	100p - 15n	1.0p - 820p	100p - 12n	1.0p - 180p	100p - 10n			
<b>1206</b>	1.0p - 47n	1.2μ - 1.5μ	1.0p - 33n	100p - 1.0μ	1.2μ	1.0p - 27n	100p - 820n	1.0μ	1.0p - 22n	100p - 470n	560n - 680n	1.0p - 8.2n	100p - 330n	1.0p - 3.9n	100p - 150n	1.0p - 2.7n	100p - 68n	1.0p - 2.7n	100p - 47n	1.0p - 1.5n	100p - 27n			
<b>1210</b>	3.9p - 100n	1.8μ - 3.3μ	3.9p - 68n	100p - 1.5μ	1.8μ - 2.7μ	3.9p - 56n	100p - 1.2μ	1.5μ - 2.2μ	3.9p - 33n	100p - 1.0μ	1.2μ - 1.5μ	3.9p - 18n	100p - 680n	3.9p - 8.2n	100p - 330n	3.9p - 6.8n	100p - 150n	3.9p - 6.8n	100p - 100n	3.9p - 2.2n	100p - 47n			
<b>1808</b>	4.7p - 100n	1.8μ - 2.7μ	4.7p - 68n	100p - 1.5μ	1.8μ - 2.2μ	4.7p - 47n	100p - 1.2μ	1.5μ	4.7p - 33n	100p - 680n	820n - 1.0μ	4.7p - 18n	100p - 560n	4.7p - 8.2n	100p - 270n	4.7p - 6.8n	100p - 150n	4.7p - 6.8n	100p - 100n	4.7p - 2.2n	100p - 47n			
<b>1812</b> T=2.5mm	10p - 220n	3.9μ - 10μ	10p - 180n	150p - 3.3μ	3.9μ - 6.8μ	10p - 150n	150p - 2.2μ	2.7μ - 4.7μ	10p - 100n	150p - 2.2μ	2.7μ - 3.3μ	10p - 47n	150p - 1.5μ	10p - 22n	150p - 680n	10p - 15n	150p - 330n	10p - 10n	150p - 180n	10p - 6.8n	150p - 100n			
<b>1812</b> T=3.2mm	—	—	—	—	—	—	—	—	—	—	—	—	—	27n	820n - 1000n	18n - 22n	390n - 470n	12n - 22n	220n - 330n	8.2n	120n - 180n			
<b>1825</b> T=2.5mm	10p - 470n	5.6μ - 15μ	10p - 330n	220p - 4.7μ	5.6μ - 12μ	10p - 220n	220p - 3.9μ	4.7μ - 10μ	10p - 150n	220p - 2.2μ	2.2μ - 6.8μ	10p - 68n	220p - 1.5μ	10p - 33n	220p - 1.0μ	10p - 27n	220p - 560n	10p - 22n	220p - 200n	10p - 12n	220p - 200n			
<b>1825</b> T=3.2mm	—	—	—	—	—	—	—	—	—	—	—	—	—	39n - 47n	—	33n	—	27n	—	15n	—			
<b>2220</b> T=2.5mm	10p - 470n	6.8μ - 18μ	10p - 330n	220p - 5.6μ	6.8μ - 12μ	10p - 220n	220p - 4.7μ	5.6μ - 10μ	10p - 150n	220p - 3.3μ	3.9μ - 6.8μ	10p - 68n	220p - 2.2μ	10p - 33n	220p - 1.0μ	10p - 22n	220p - 560n	10p - 18n	220p - 330n	10p - 15n	220p - 120n			
<b>2220</b> T=4.2mm	—	—	—	—	—	—	—	—	—	—	—	—	—	39n - 56n	1.2μ - 2.2μ	27n - 39n	680n - 1μ	22n - 33n	390n - 1μ	18n - 22n	150n - 470n			
<b>2225</b> T=2.5mm	10p - 560n	8.2μ - 22μ	10p - 470n	330p - 6.8μ	8.2μ - 15μ	10p - 330n	330p - 5.6μ	6.8μ - 12μ	10p - 220n	330p - 3.3μ	3.9μ - 10μ	10p - 82n	330p - 2.7μ	10p - 47n	330p - 1.5μ	10p - 33n	330p - 820n	10p - 22n	330p - 390n	10p - 18n	330p - 150n			
<b>2225</b> T=4.0mm	—	—	—	—	—	—	—	—	—	—	—	—	—	56n - 68n	—	39n - 47n	—	27n - 39n	—	22n - 27n	—			
<b>3640</b> T=2.5mm	—	—	—	—	—	—	—	—	—	—	—	10p - 330n	470p - 10μ	—	10p - 270n	470p - 5.6μ	10p - 120n	470p - 3.3μ	10p - 82n	470p - 1.0μ	470p - 680n			
<b>3640</b> T=4.0mm	—	—	—	—	—	—	—	—	—	—	—	—	—	150n - 180n	3.9μ - 5.6μ	100n - 120n	1.2μ - 2.7μ	82n - 100n	820n - 2.2μ	56n - 82n	220n - 1μ			
<b>5550</b> T=2.5mm	—	—	—	—	—	—	—	—	—	—	—	27p - 680n	1.0n - 15μ	—	27p - 470n	1.0n - 10μ	27p - 270n	1.0n - 5.6μ	27p - 180n	1.0n - 1.8μ	27p - 120n	1.0n - 1.2μ	27p - 82n	1.0n - 390n
<b>5550</b> T=4.0mm	—	—	—	—	—	—	—	—	—	—	—	—	—	—	330n	—	220n - 270n	—	150n - 180n	—	100n - 150n	—		
<b>8060</b> T=2.5mm	—	—	—	—	—	—	—	—	—	—	—	47p - 1.0μ	2.2n - 22μ	—	47p - 680n	2.2n - 15μ	47p - 390n	2.2n - 10μ	47p - 3.3μ	2.2n - 220n	47p - 2.2μ	2.2n - 150n	2.2n - 1.0μ	
<b>8060</b> T=4.0mm	—	—	—	—	—	—	—	—	—	—	—	—	—	—	470n - 560n	—	330n - 470n	—	270n - 390n	—	180n - 270n	—		

DLI-JohansonMFG-Novacap-Syfer-Voltronics

Note: 0505, 1111 and 2211 case sizes are available in our specialty ranges. Please refer to the relevant sections of this catalogue for more details.

Notes: 1) Capacitance in F - min value above max value. 2) \*These parts may require conformal coating post soldering. 3) T = Maximum thickness.  
 4) Higher capacitance values available from the NC range - see page 63. 5) StackiCap™ high capacitance versions are now available. Please refer to datasheet.  
 6) Parts in this range may be defined as dual-use under export control legislation as such may be subject to export licence restrictions. Please refer to p12 for more information on the dual-use regulations and contact the Sales Office for further information on specific part numbers.



1.2kV		1.5kV		2kV		2.5kV		3kV		4kV		5kV		6kV		8kV		10kV		12kV		
COG/ NPO	X7R	COG/ NPO	X7R	COG/ NPO	X7R	COG/ NPO	X7R	COG/ NPO	X7R	COG/ NPO	X7R	COG/ NPO	X7R	COG/ NPO	X7R	COG/ NPO	X7R	COG/ NPO	X7R	COG/ NPO	X7R	
—	—	—	—	—	—	—	—	—	—	—	—	—	—	—	—	—	—	—	—	—	—	0402
—	—	—	—	—	—	—	—	—	—	—	—	—	—	—	—	—	—	—	—	—	—	0603
1.0p - 120p	—	1.0p - 82p	—	1.0p - 47p	—	—	—	—	—	—	—	—	—	—	—	—	—	—	—	—	—	0805
1.0p - 680p	100p - 15n	1.0p - 330p	100p - 10n	1.0p - 220p	100p - 3.3n <sup>1</sup>	1.0p - 100p	100p - 2.7n <sup>1</sup>	1.0p - 68p	100p - 1.5n <sup>1</sup>	—	—	—	—	—	—	—	—	—	—	—	—	1206
3.9p - 1.5n	100p - 18n	3.9p - 820p	100p - 12n	3.9p - 470p	100p - 5.6n <sup>1</sup>	3.9p - 220p	100p - 4.7n <sup>1</sup>	3.9p - 150p	100p - 3.3n <sup>1</sup>	—	—	—	—	—	—	—	—	—	—	—	—	1210
4.7p - 1.5n	100p - 22n	4.7p - 1.0n	100p - 15n	4.7p - 470p	100p - 5.6n <sup>1</sup>	4.7p - 270p	100p - 4.7n <sup>1</sup>	4.7p - 220p	100p - 3.3n <sup>1</sup>	4.7p - 120p*	100p - 2.2n* <sup>1</sup>	4.7p - 68p*	100p - 680p* <sup>1</sup>	4.7p - 47p*	100p - 390p* <sup>1</sup>	—	—	—	—	—	—	1808
10p - 4.7n	150p - 33n	10p - 2.7n	150p - 22n	10p - 1.5n	150p - 10n <sup>1</sup>	10p - 820p	150p - 8.2n <sup>1</sup>	10p - 560p	150p - 4.7n <sup>1</sup>	10p - 270p*	150p - 3.3n* <sup>1</sup>	10p - 180p*	150p - 1.2n* <sup>1</sup>	10p - 120p*	150p - 1.0n* <sup>1</sup>	—	—	—	—	—	—	1812 T=2.5mm
5.6n - 6.8n	39n - 100n	3.3n	27n - 56n	1.8n	12n - 33n	1.0n	—	680p	—	330p - 390p*	—	220p - 270p*	—	150p - 180p*	—	—	—	—	—	—	—	1812 T=3.2mm
10p - 6.8n	220p - 68n	10p - 4.7n	220p - 47n	10p - 3.3n	220p - 10n	10p - 1.5n	220p - 6.8n	10p - 1.2n	220p - 3.9n	10p - 560p*	10p - 2.2n*	10p - 390p*	10p - 1.8n*	10p - 270p*	10p - 1.5n*	—	—	—	—	—	—	1825 T=2.5mm
8.2n - 10n	—	5.6n - 6.8n	—	3.9n	—	1.8n - 2.2n	—	1.5n	—	680p*	—	470p*	—	330p*	—	—	—	—	—	—	—	1825 T=3.2mm
10p - 10n	220p - 82n	10p - 5.6n	220p - 47n	10p - 3.3n	220p - 33n	10p - 1.8n	220p - 22n <sup>1</sup>	10p - 1.5n	220p - 10n <sup>1</sup>	10p - 680p*	10p - 6.8n* <sup>1</sup>	10p - 470p*	10p - 4.7n* <sup>1</sup>	10p - 330p*	10p - 2.2n* <sup>1</sup>	—	—	—	—	—	—	2220 T=2.5mm
12n - 15n	100n - 220n	6.8n - 10n	50n - 150n	3.9n - 5.6n	39n - 100n	2.2n - 3.3n	—	1.8n - 2.2n	—	820p - 1.2n*	—	560p - 820p*	—	390p - 560p*	—	—	—	—	—	—	—	2220 T=4.2mm
10p - 12n	330p - 100n	10p - 6.8n	330p - 68n	10p - 4.7n	330p - 33n	10p - 2.2n	330p - 12n	10p - 1.8n	330p - 8.2n	10p - 820p*	10p - 5.6n*	10p - 560p*	10p - 4.7n*	10p - 390p*	10p - 2.7n*	—	—	—	—	—	—	2225 T=2.5mm
15n - 22n	—	8.2n - 12n	—	5.6n - 6.8n	—	2.7n - 3.9n	—	2.2n - 2.7n	—	1.0n - 1.5n*	—	680p - 1.0n*	—	470p - 680p*	—	—	—	—	—	—	—	2225 T=4.0mm
10p - 33n	470p - 150n	10p - 22n	470p - 100n	10p - 10n	470p - 47n	10p - 6.8n	470p - 33n	10p - 4.7n	470p - 22n	10p - 1.8n	470p - 6.8n	10p - 1.5n	470p - 5.6n	10p - 1.0n	470p - 4.7n	10p - 150p	470p - 1.5n*	10p - 100p	470p - 1.0n*	10p - 68p	470p - 820p*	3640 T=2.5mm
39n - 56n	180n - 470n	27n - 39n	120n - 330n	12n - 18n	56n - 150n	8.2n - 12n	—	5.6n - 8.2n	—	2.2n - 3.3n	—	1.8n - 2.2n	—	1.2n - 1.5n	—	—	—	—	—	—	—	3640 T=4.0mm
27p - 68n	1.0n - 220n	27p - 39n	1.0n - 150n	27p - 22n	1.0n - 82n	27p - 12n	1.0n - 68n	27p - 10n	1.0n - 47n	27p - 4.7n	1.0n - 15n	27p - 2.7n	1.0n - 10n	27p - 1.8n	1.0n - 8.2n	27p - 330p	1.0n - 4.7n*	27p - 180p	1.0n - 2.2n*	27p - 120p	1.0n - 1.2n*	5550 T=2.5mm
82n - 100n	—	47n - 68n	—	27n - 39n	—	15n - 22n	—	12n - 18n	—	5.6n - 6.8n	—	3.3n - 4.7n	—	2.2n - 3.3n	—	—	—	—	—	—	—	5550 T=4.0mm
47p - 100n	2.2n - 470n	47p - 68n	2.2n - 330n	47p - 39n	2.2n - 150n	47p - 22n	2.2n - 100n	47p - 15n	2.2n - 82n	47p - 8.2n	2.2n - 33n	47p - 5.6n	2.2n - 22n	47p - 3.9n	2.2n - 15n	47p - 680p	2.2n - 6.8n*	47p - 470p	2.2n - 4.7n*	47p - 220p	2.2n - 2.2n*	8060 T=2.5mm
120n - 180n	—	82n - 120n	—	47n - 68n	—	27n - 39n	—	18n - 27n	—	10n - 15n	—	6.8n - 10n	—	4.7n - 6.8n	—	—	—	—	—	—	—	8060 T=4.0mm

# Industry Standard - MLC chip range - X7R



Capacitance	Code	0402	0603	0805	1206	Capacitance	Code
100pF	101					100pF	101
120	121					120	121
150	151					150	151
180	181					180	181
220	221					220	221
270	271					270	271
330	331					330	331
390	391					390	391
470	471					470	471
560	561					560	561
680	681					680	681
820	821					820	821
1.0nF	102					1.0nF	102
1.2	122					1.2	122
1.5	152					1.5	152
1.8	182					1.8	182
2.2	222					2.2	222
2.7	272					2.7	272
3.3	332					3.3	332
3.9	392					3.9	392
4.7	472					4.7	472
5.6	562					5.6	562
6.8	682					6.8	682
8.2	822					8.2	822
10nF	103					10nF	103
12	123					12	123
15	153					15	153
18	183					18	183
22	223					22	223
27	273					27	273
33	333					33	333
39	393					39	393
47	473					47	473
56	563					56	563
68	683					68	683
82	823					82	823
100nF	104					100nF	104
120	124					120	124
150	154					150	154
180	184					180	184
220	224					220	224
270	274					270	274
330	334					330	334
390	394					390	394
470	474					470	474
560	564					560	564
680	684					680	684
820	824					820	824
1.0µF	105					1.0µF	105
1.2	125					1.2	125
1.5	155					1.5	155
1.8	185					1.8	185
2.2	225					2.2	225
2.7	275					2.7	275
3.3	335					3.3	335
3.9	395					3.9	395
4.7	475					4.7	475
5.6	565					5.6	565
6.8	685					6.8	685
8.2	825					8.2	825
10µF	106					10µF	106
12	126					12	126
15	156					15	156
18	186					18	186
22µF	226					22µF	226

For 0504, 0907, 1005, 2020, 2221, 4040, 5440 and 43100 range information please refer to your local Knowles Sales Office.

- \* StackiCap™ high capacitance versions available from the StackiCap™ range - see page 62 for details.
- † Higher capacitance values available from the NC capacitor range - see page 63 for details.
- \*\* Max. capacitance of 27nF, has increased chip length of 3.5mm. Reduced max. cap value of 22nF, for standard dimension.
- = AEC-Q200 approved parts - maximum values.
- ▲ For 0603 50/63V values from 68nF to 100nF should be ordered with FB6 suffix.

Capacitance	Code
100pF	101
120	121
150	151
180	181
220	221
270	271
330	331
390	391
470	471
560	561
680	681
820	821
1.0nF	102
1.2	122
1.5	152
1.8	182
2.2	222
2.7	272
3.3	332
3.9	392
4.7	472
5.6	562
6.8	682
8.2	822
10nF	103
12	123
15	153
18	183
22	223
27	273
33	333
39	393
47	473
56	563
68	683
82	823
100nF	104
120	124
150	154
180	184
220	224
270	274
330	334
390	394
470	474
560	564
680	684
820	824
1.0µF	105
1.2	125
1.5	155
1.8	185
2.2	225
2.7	275
3.3	335
3.9	395
4.7	475
5.6	565
6.8	685
8.2	825
10µF	106
12	126
15	156
18	186
22µF	226

1210



1808

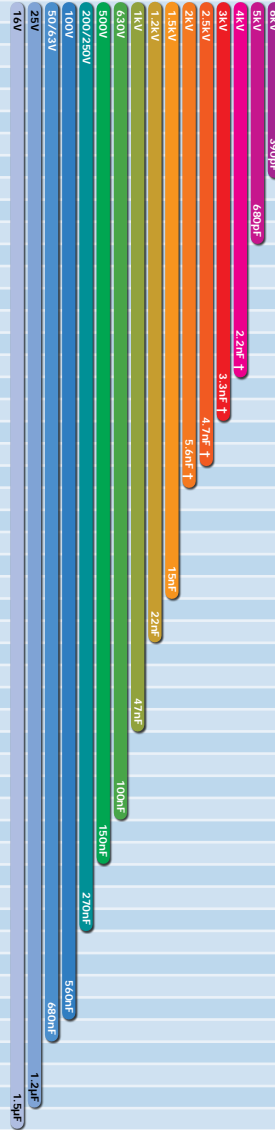

Capacitance	Code
100pF	101
120	121
150	151
180	181
220	221
270	271
330	331
390	391
470	471
560	561
680	681
820	821
1.0nF	102
1.2	122
1.5	152
1.8	182
2.2	222
2.7	272
3.3	332
3.9	392
4.7	472
5.6	562
6.8	682
8.2	822
10nF	103
12	123
15	153
18	183
22	223
27	273
33	333
39	393
47	473
56	563
68	683
82	823
100nF	104
120	124
150	154
180	184
220	224
270	274
330	334
390	394
470	474
560	564
680	684
820	824
1.0µF	105
1.2	125
1.5	155
1.8	185
2.2	225
2.7	275
3.3	335
3.9	395
4.7	475
5.6	565
6.8	685
8.2	825
10µF	106
12	126
15	156
18	186
22µF	226

# Industry Standard - MLC chip range - X7R

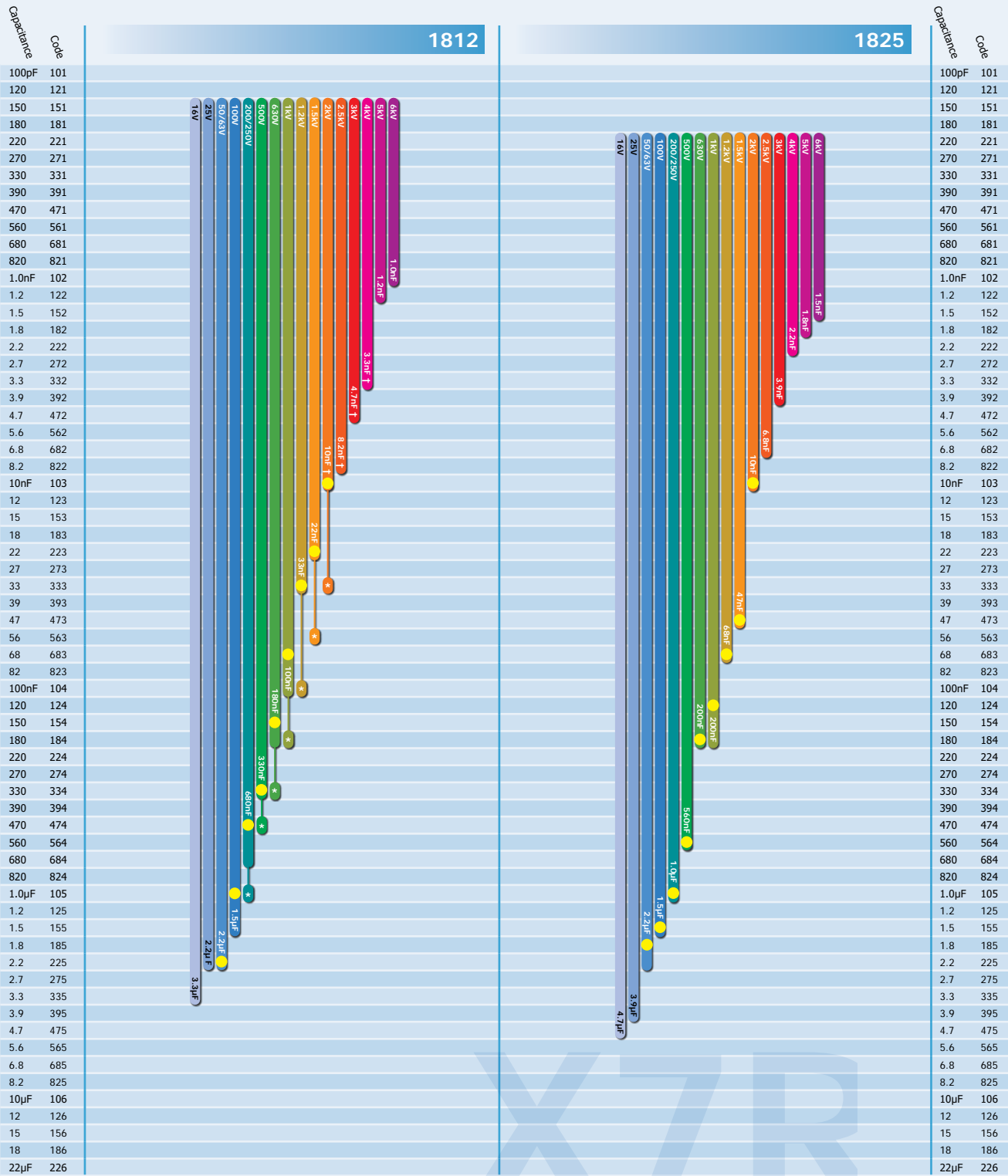

For 0504, 0907, 1005, 2020, 2221, 4040, 5440 and 43100 range information please refer to your local Knowles Sales Office.

\* StackiCap™ high capacitance versions available from the StackiCap™ range - see page 62 for details.  
 † Higher capacitance values available from the NC capacitor range - see page 63 for details.  
 ● = AEC-Q200 approved parts - maximum values.





Capacitance	Code
100pF	101
120	121
150	151
180	181
220	221
270	271
330	331
390	391
470	471
560	561
680	681
820	821
1.0nF	102
1.2	122
1.5	152
1.8	182
2.2	222
2.7	272
3.3	332
3.9	392
4.7	472
5.6	562
6.8	682
8.2	822
10nF	103
12	123
15	153
18	183
22	223
27	273
33	333
39	393
47	473
56	563
68	683
82	823
100nF	104
120	124
150	154
180	184
220	224
270	274
330	334
390	394
470	474
560	564
680	684
820	824
1.0µF	105
1.2	125
1.5	155
1.8	185
2.2	225
2.7	275
3.3	335
3.9	395
4.7	475
5.6	565
6.8	685
8.2	825
10µF	106
12	126
15	156
18	186
22µF	226

2220

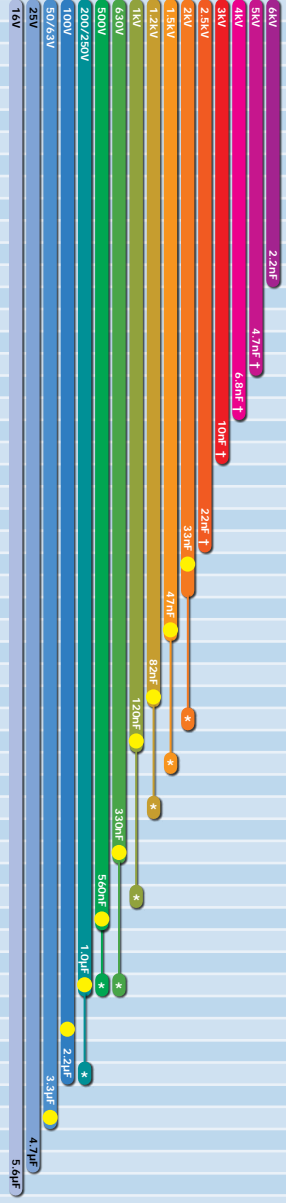

2225



Capacitance	Code
100pF	101
120	121
150	151
180	181
220	221
270	271
330	331
390	391
470	471
560	561
680	681
820	821
1.0nF	102
1.2	122
1.5	152
1.8	182
2.2	222
2.7	272
3.3	332
3.9	392
4.7	472
5.6	562
6.8	682
8.2	822
10nF	103
12	123
15	153
18	183
22	223
27	273
33	333
39	393
47	473
56	563
68	683
82	823
100nF	104
120	124
150	154
180	184
220	224
270	274
330	334
390	394
470	474
560	564
680	684
820	824
1.0µF	105
1.2	125
1.5	155
1.8	185
2.2	225
2.7	275
3.3	335
3.9	395
4.7	475
5.6	565
6.8	685
8.2	825
10µF	106
12	126
15	156
18	186
22µF	226

# Industry Standard - MLC chip range - COG/NPO



Capacitance	Code	0402	0603	0805	1206	Capacitance	Code
0.33pF	p33					0.33pF	p33
0.47	p47					0.47	p47
0.50	p50					0.50	p50
1.0	1p0					1.0	1p0
1.2	1p2					1.2	1p2
1.5	1p5					1.5	1p5
1.8	1p8					1.8	1p8
2.2	2p2					2.2	2p2
2.7	2p7					2.7	2p7
3.3	3p3					3.3	3p3
3.9	3p9					3.9	3p9
4.7	4p7					4.7	4p7
5.6	5p6					5.6	5p6
6.8	6p8					6.8	6p8
8.2	8p2					8.2	8p2
10pF	100					10pF	100
12	120					12	120
15	150					15	150
18	180					18	180
22	220					22	220
27	270					27	270
33	330					33	330
39	390					39	390
47	470					47	470
56	560					56	560
68	680					68	680
82	820					82	820
100pF	101					100pF	101
120	121					120	121
150	151					150	151
180	181					180	181
220	221					220	221
270	271					270	271
330	331					330	331
390	391					390	391
470	471					470	471
560	561					560	561
680	681					680	681
820	821					820	821
1.0nF	102					1.0nF	102
1.2	122					1.2	122
1.5	152					1.5	152
1.8	182					1.8	182
2.2	222					2.2	222
2.7	272					2.7	272
3.3	332					3.3	332
3.9	392					3.9	392
4.7	472					4.7	472
5.6	562					5.6	562
6.8	682					6.8	682
8.2	822					8.2	822
10nF	103					10nF	103
12	123					12	123
15	153					15	153
18	183					18	183
22	223					22	223
27	273					27	273
33	333					33	333
39	393					39	393
47	473					47	473
56	563					56	563
68	683					68	683
82	823					82	823
100nF	104					100nF	104
120	124					120	124
150	154					150	154
180	184					180	184
220	224					220	224
270	274					270	274
330	334					330	334
390	394					390	394
470	474					470	474
560	564					560	564
680	684					680	684
820	824					820	824
1.0µF	105					1.0µF	105

For 0504, 0907, 1005, 2020, 2221, 4040, 5440 and 43100 range information please refer to your local Knowles Sales Office.

Capacitance	Code
0.33pF	p33
0.47	p47
0.50	p50
1.0	1p0
1.2	1p2
1.5	1p5
1.8	1p8
2.2	2p2
2.7	2p7
3.3	3p3
3.9	3p9
4.7	4p7
5.6	5p6
6.8	6p8
8.2	8p2
10pF	100
12	120
15	150
18	180
22	220
27	270
33	330
39	390
47	470
56	560
68	680
82	820
100pF	101
120	121
150	151
180	181
220	221
270	271
330	331
390	391
470	471
560	561
680	681
820	821
1.0nF	102
1.2	122
1.5	152
1.8	182
2.2	222
2.7	272
3.3	332
3.9	392
4.7	472
5.6	562
6.8	682
8.2	822
10nF	103
12	123
15	153
18	183
22	223
27	273
33	333
39	393
47	473
56	563
68	683
82	823
100nF	104
120	124
150	154
180	184
220	224
270	274
330	334
390	394
470	474
560	564
680	684
820	824
1.0µF	105

1210



1808

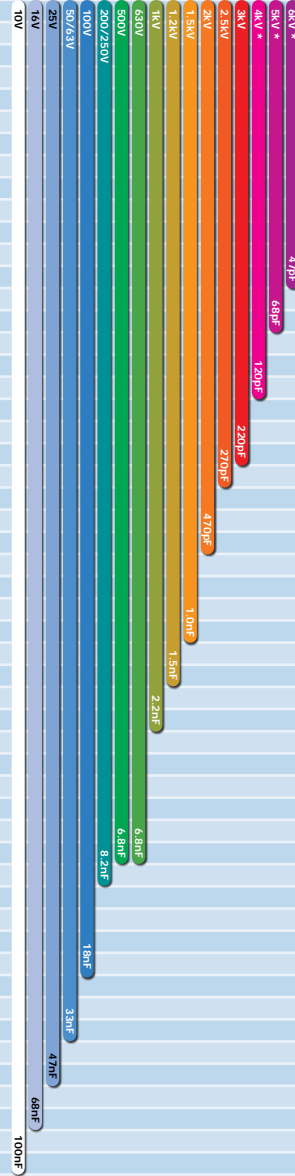

Capacitance	Code
0.33pF	p33
0.47	p47
0.50	p50
1.0	1p0
1.2	1p2
1.5	1p5
1.8	1p8
2.2	2p2
2.7	2p7
3.3	3p3
3.9	3p9
4.7	4p7
5.6	5p6
6.8	6p8
8.2	8p2
10pF	100
12	120
15	150
18	180
22	220
27	270
33	330
39	390
47	470
56	560
68	680
82	820
100pF	101
120	121
150	151
180	181
220	221
270	271
330	331
390	391
470	471
560	561
680	681
820	821
1.0nF	102
1.2	122
1.5	152
1.8	182
2.2	222
2.7	272
3.3	332
3.9	392
4.7	472
5.6	562
6.8	682
8.2	822
10nF	103
12	123
15	153
18	183
22	223
27	273
33	333
39	393
47	473
56	563
68	683
82	823
100nF	104
120	124
150	154
180	184
220	224
270	274
330	334
390	394
470	474
560	564
680	684
820	824
1.0µF	105

Notes: 1) \* These parts may require conformal coating post soldering.  
 2) Standard chip thickness = 2.5mm maximum unless specified as 3.2 or 4.0mm.

3) ▲ For 1210 630V 6.8nF, order with AG1 suffix.

# Industry Standard - MLC chip range - COG/NPO



1812		1825	
Capacitance	Code	Capacitance	Code
0.33pF	p33	0.33pF	p33
0.47	p47	0.47	p47
0.50	p50	0.50	p50
1.0	1p0	1.0	1p0
1.2	1p2	1.2	1p2
1.5	1p5	1.5	1p5
1.8	1p8	1.8	1p8
2.2	2p2	2.2	2p2
2.7	2p7	2.7	2p7
3.3	3p3	3.3	3p3
3.9	3p9	3.9	3p9
4.7	4p7	4.7	4p7
5.6	5p6	5.6	5p6
6.8	6p8	6.8	6p8
8.2	8p2	8.2	8p2
10pF	100	10pF	100
12	120	12	120
15	150	15	150
18	180	18	180
22	220	22	220
27	270	27	270
33	330	33	330
39	390	39	390
47	470	47	470
56	560	56	560
68	680	68	680
82	820	82	820
100pF	101	100pF	101
120	121	120	121
150	151	150	151
180	181	180	181
220	221	220	221
270	271	270	271
330	331	330	331
390	391	390	391
470	471	470	471
560	561	560	561
680	681	680	681
820	821	820	821
1.0nF	102	1.0nF	102
1.2	122	1.2	122
1.5	152	1.5	152
1.8	182	1.8	182
2.2	222	2.2	222
2.7	272	2.7	272
3.3	332	3.3	332
3.9	392	3.9	392
4.7	472	4.7	472
5.6	562	5.6	562
6.8	682	6.8	682
8.2	822	8.2	822
10nF	103	10nF	103
12	123	12	123
15	153	15	153
18	183	18	183
22	223	22	223
27	273	27	273
33	333	33	333
39	393	39	393
47	473	47	473
56	563	56	563
68	683	68	683
82	823	82	823
100nF	104	100nF	104
120	124	120	124
150	154	150	154
180	184	180	184
220	224	220	224
270	274	270	274
330	334	330	334
390	394	390	394
470	474	470	474
560	564	560	564
680	684	680	684
820	824	820	824
1.0µF	105	1.0µF	105

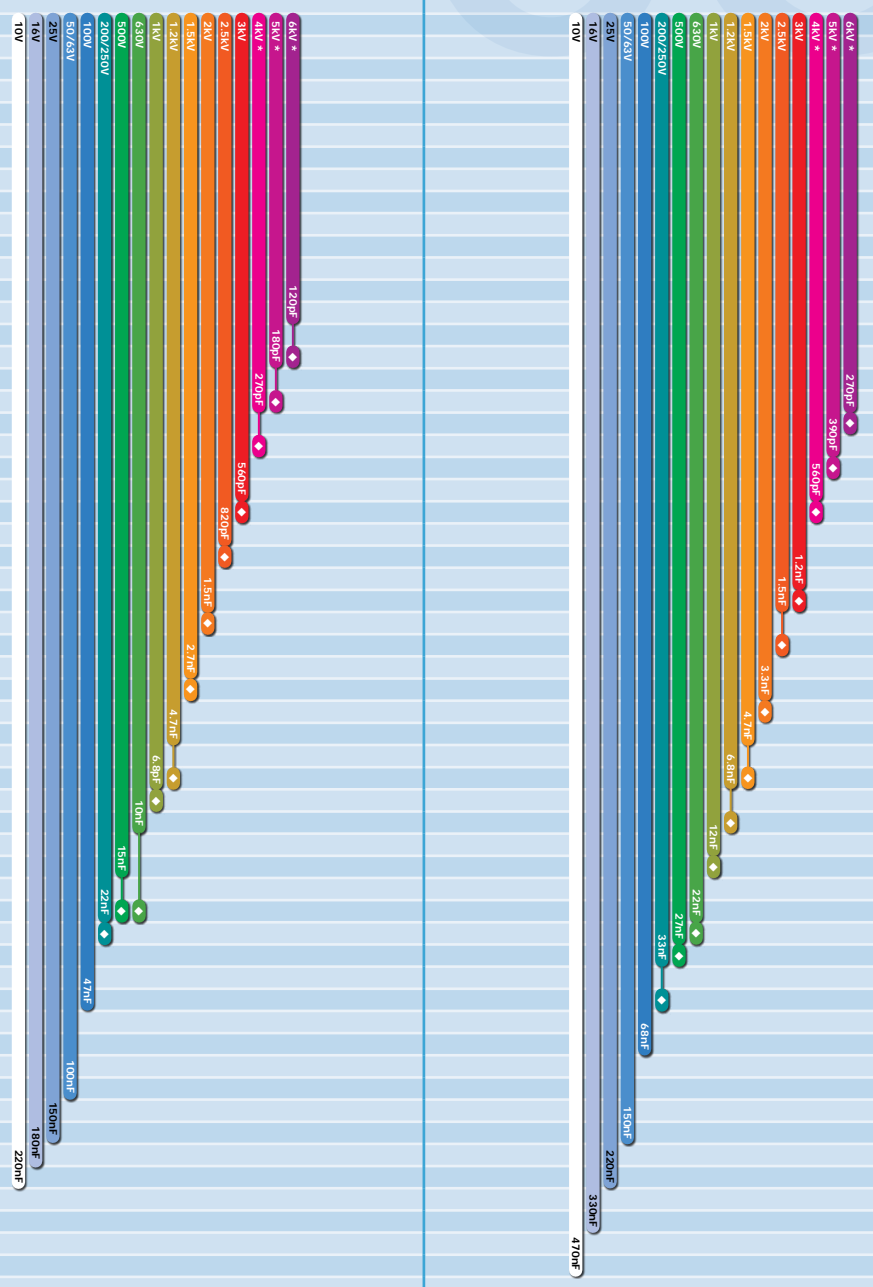

Capacitance	Code
0.33pF	p33
0.47	p47
0.50	p50
1.0	1p0
1.2	1p2
1.5	1p5
1.8	1p8
2.2	2p2
2.7	2p7
3.3	3p3
3.9	3p9
4.7	4p7
5.6	5p6
6.8	6p8
8.2	8p2
10pF	100
12	120
15	150
18	180
22	220
27	270
33	330
39	390
47	470
56	560
68	680
82	820
100pF	101
120	121
150	151
180	181
220	221
270	271
330	331
390	391
470	471
560	561
680	681
820	821
1.0nF	102
1.2	122
1.5	152
1.8	182
2.2	222
2.7	272
3.3	332
3.9	392
4.7	472
5.6	562
6.8	682
8.2	822
10nF	103
12	123
15	153
18	183
22	223
27	273
33	333
39	393
47	473
56	563
68	683
82	823
100nF	104
120	124
150	154
180	184
220	224
270	274
330	334
390	394
470	474
560	564
680	684
820	824
1.0µF	105

2220

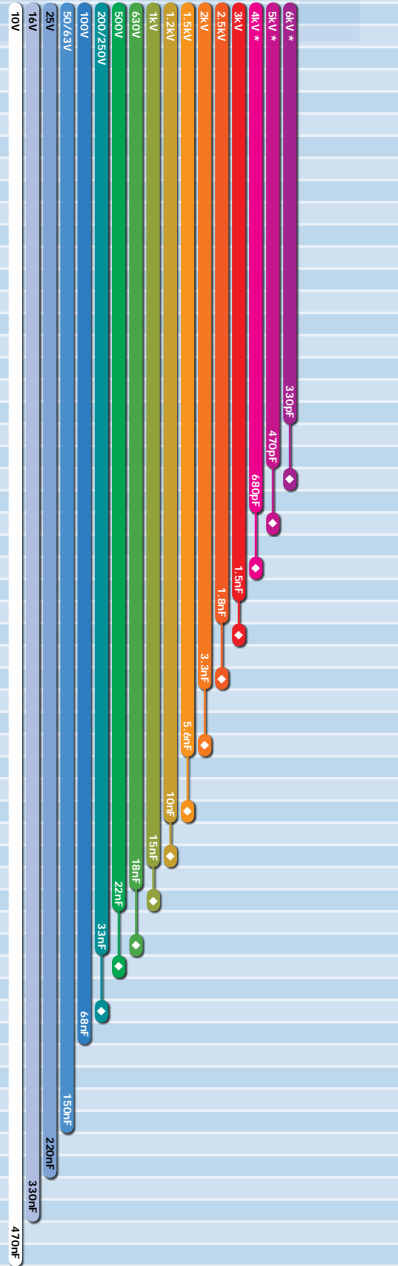

2225

For 0504, 0907, 1005, 2020, 2221, 4040, 5440 and 43100 range information please refer to your local Knowles Sales Office.

Capacitance	Code
0.33pF	p33
0.47	p47
0.50	p50
1.0	1p0
1.2	1p2
1.5	1p5
1.8	1p8
2.2	2p2
2.7	2p7
3.3	3p3
3.9	3p9
4.7	4p7
5.6	5p6
6.8	6p8
8.2	8p2
10pF	100
12	120
15	150
18	180
22	220
27	270
33	330
39	390
47	470
56	560
68	680
82	820
100pF	101
120	121
150	151
180	181
220	221
270	271
330	331
390	391
470	471
560	561
680	681
820	821
1.0nF	102
1.2	122
1.5	152
1.8	182
2.2	222
2.7	272
3.3	332
3.9	392
4.7	472
5.6	562
6.8	682
8.2	822
10nF	103
12	123
15	153
18	183
22	223
27	273
33	333
39	393
47	473
56	563
68	683
82	823
100nF	104
120	124
150	154
180	184
220	224
270	274
330	334
390	394
470	474
560	564
680	684
820	824
1.0µF	105

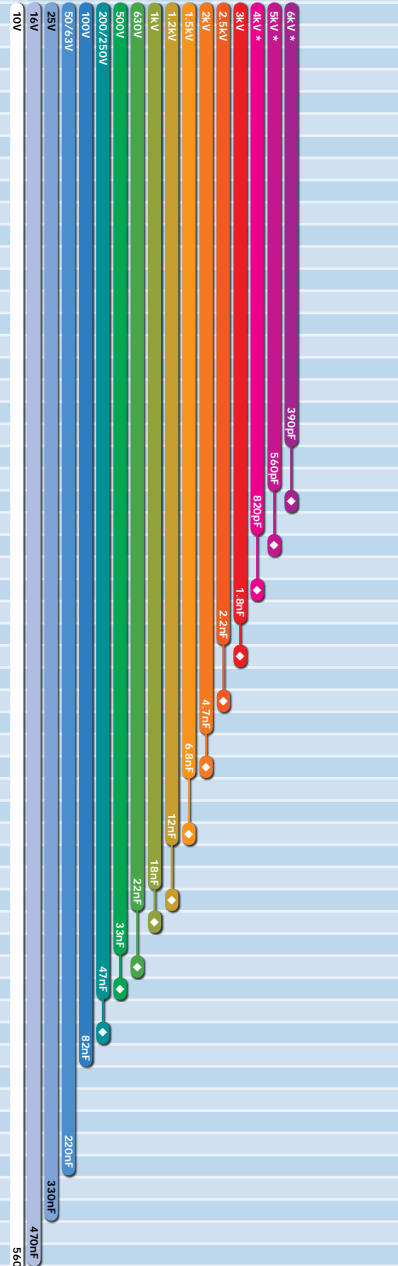

Notes: 1) \* These parts may require conformal coating post soldering.  
 2) ♦ Standard chip thickness = 2.5mm maximum unless specified as 3.2 or 4.0mm.

# Other Popular Sizes - MLC chip range - X7R

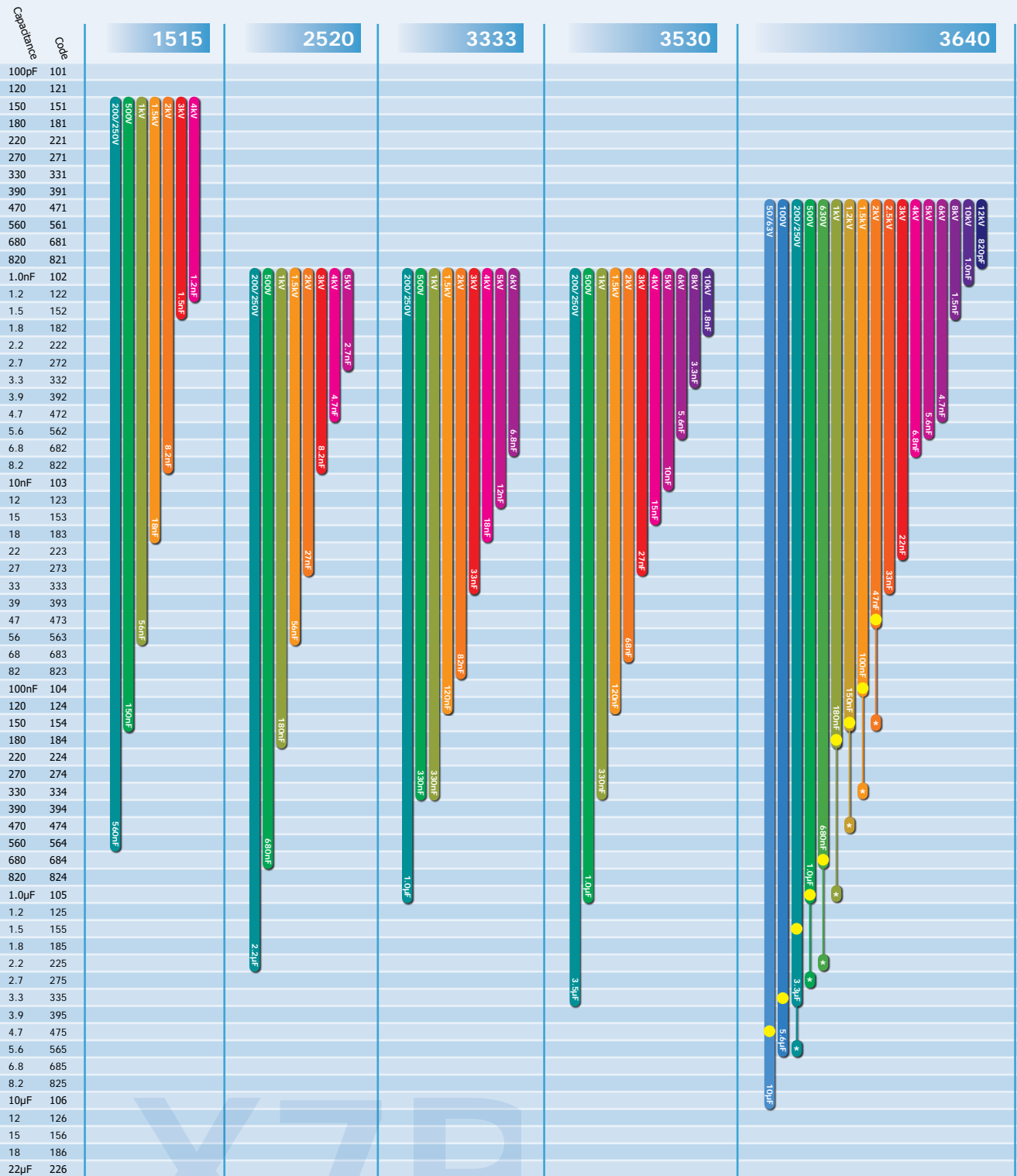
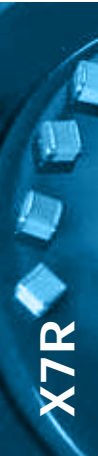

\* StackiCap™ high capacitance versions available from the StackiCap™ range - see page 62 for details.

● = AEC-Q200 approved parts - maximum values.

Code	Capacitance
101	100pF
121	120
151	150
181	180
221	220
271	270
331	330
391	390
471	470
561	560
681	680
821	820
102	1.0nF
122	1.2
152	1.5
182	1.8
222	2.2
272	2.7
332	3.3
392	3.9
472	4.7
562	5.6
682	6.8
822	8.2
103	10nF
123	12
153	15
183	18
223	22
273	27
333	33
393	39
473	47
563	56
683	68
823	82
104	100nF
124	120
154	150
184	180
224	220
274	270
334	330
394	390
474	470
564	560
684	680
824	820
105	1.0µF
125	1.2
155	1.5
185	1.8
225	2.2
275	2.7
335	3.3
395	3.9
475	4.7
565	5.6
685	6.8
825	8.2
106	10µF
126	12
156	15
186	18
226	22µF

Code	Capacitance
5550	12kV 1.2nF
6560	10kV 2.2nF
7565	10kV 4.7nF
8060	12kV 2.2nF

Code	Capacitance
5550	10kV 4.7nF
6560	8kV 8.2nF
7565	6kV 15nF
8060	10kV 15nF

Code	Capacitance
5550	10kV 10nF
6560	8kV 15nF
7565	6kV 33nF
8060	10kV 33nF

Code	Capacitance
5550	10kV 47nF
6560	8kV 82nF
7565	6kV 100nF
8060	10kV 100nF

Code	Capacitance
5550	10kV 150nF
6560	8kV 220nF
7565	6kV 330nF
8060	10kV 330nF

Code	Capacitance
5550	10kV 390nF
6560	8kV 470nF
7565	6kV 680nF
8060	10kV 680nF

Code	Capacitance
5550	10kV 1.2µF
6560	8kV 1.8µF
7565	6kV 3.3µF
8060	10kV 3.3µF

Code	Capacitance
5550	10kV 5.6µF
6560	8kV 10µF
7565	6kV 15µF
8060	10kV 15µF

Note:  
 ● The highlighted parts may be defined as dual-use under export control legislation as such may be subject to export licence restrictions. Please refer to page 12 for more information on the dual-use regulations and contact the Sales Office for further information on specific part numbers.

# Other Popular Sizes - MLC chip range - COG/NPO



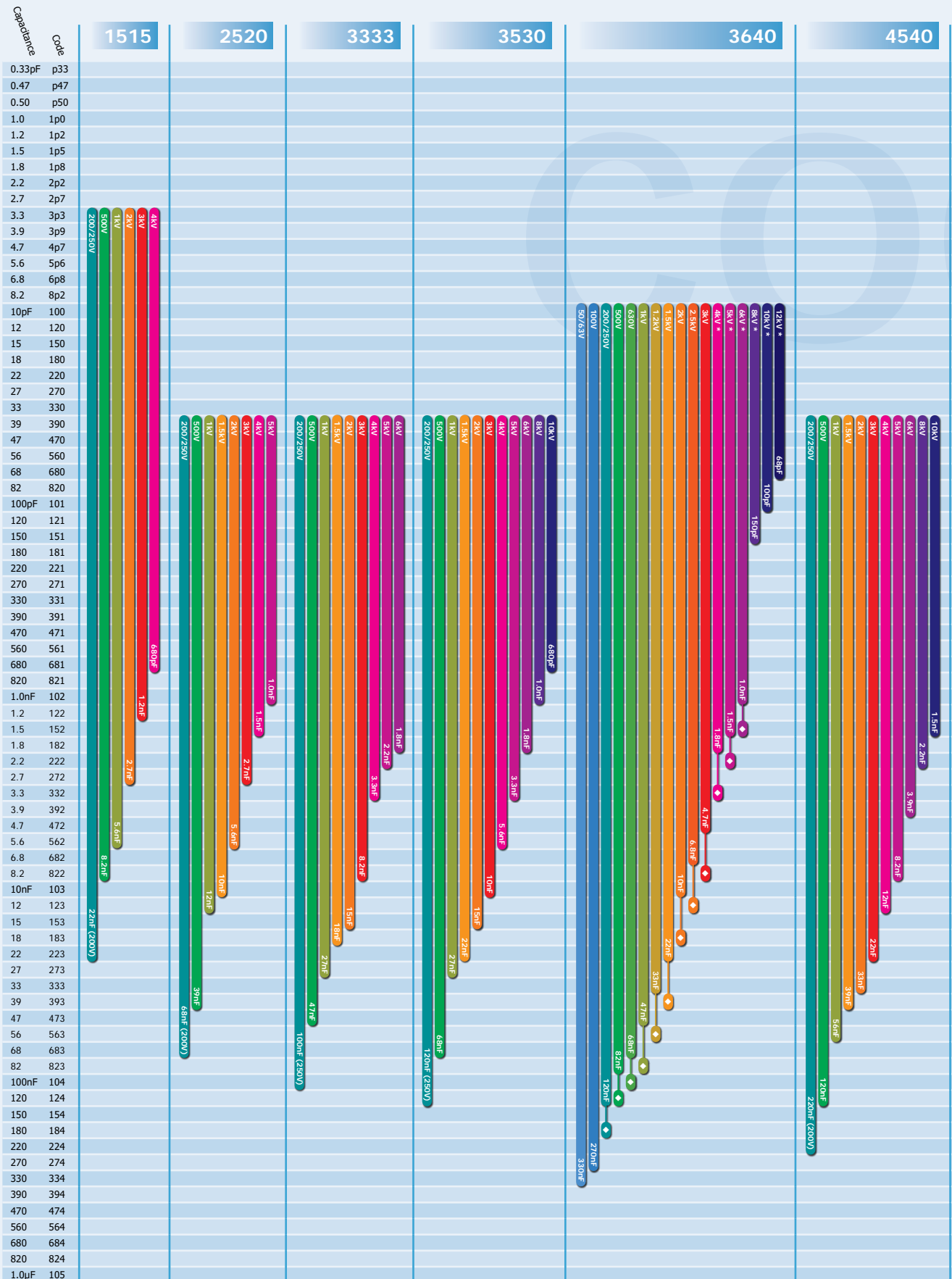

Capacitance	Code
0.33pF	p33
0.47	p47
0.50	p50
1.0	1p0
1.2	1p2
1.5	1p5
1.8	1p8
2.2	2p2
2.7	2p7
3.3	3p3
3.9	3p9
4.7	4p7
5.6	5p6
6.8	6p8
8.2	8p2
10pF	100
12	120
15	150
18	180
22	220
27	270
33	330
39	390
47	470
56	560
68	680
82	820
100pF	101
120	121
150	151
180	181
220	221
270	271
330	331
390	391
470	471
560	561
680	681
820	821
1.0nF	102
1.2	122
1.5	152
1.8	182
2.2	222
2.7	272
3.3	332
3.9	392
4.7	472
5.6	562
6.8	682
8.2	822
10nF	103
12	123
15	153
18	183
22	223
27	273
33	333
39	393
47	473
56	563
68	683
82	823
100nF	104
120	124
150	154
180	184
220	224
270	274
330	334
390	394
470	474
560	564
680	684
820	824
1.0µF	105

8060

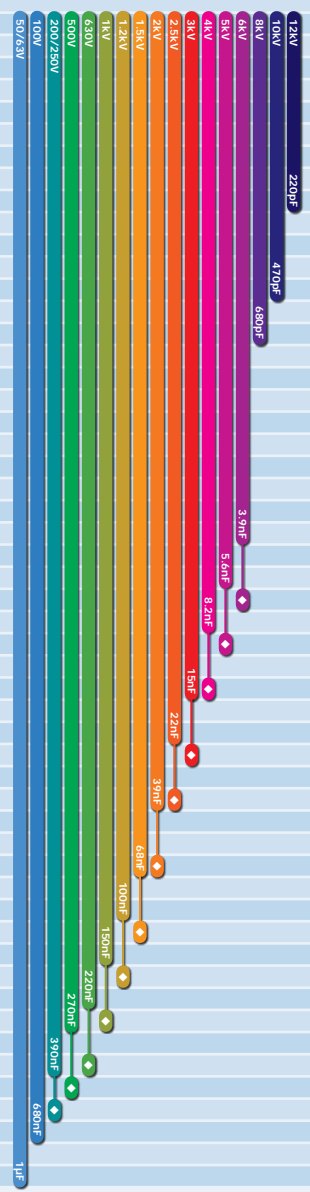

7565

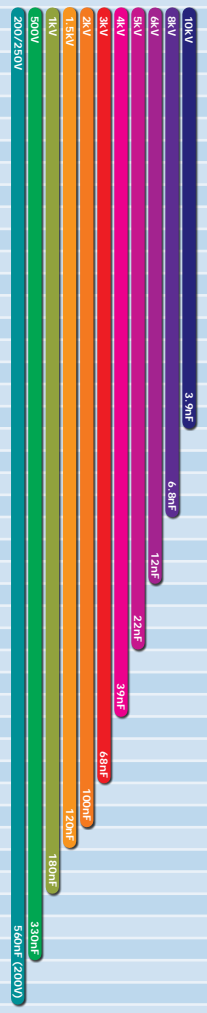

6560

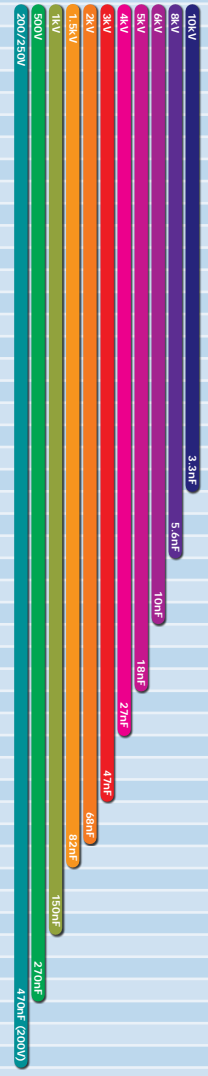

5550

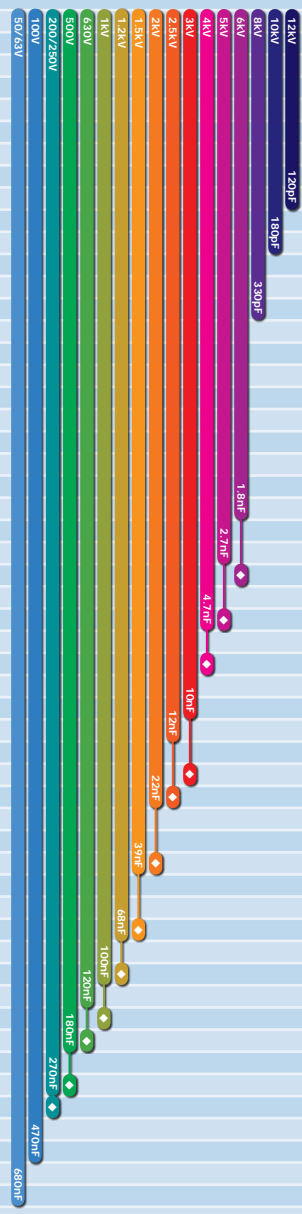

Note: \* These parts may require conformal coating post soldering.

# Standard Chip - BX

Manufactured with layer thickness, and minimal voltage coefficient, to meet BX requirements. BX characteristics are identical to X7R dielectric with the added restriction that the Temperature-Voltage Coefficient (TVC) does not exceed -25% at rated voltage, over -55°C to 125°C operating temperature.

High Reliability Testing available: HB = MIL-PRF-55681 Group A. HK = MIL-PRF-38534 Class K. HS = MIL-PRF-123 Group A.

- For dimensions see page 20.
- For termination types see page 6.
- For ordering information see page 22.



## Capacitance and Voltage Selection - BX

Size	0402	0504	0603	0805	1005	1206	1210	1808	1812	1825	2221	2225
Min cap.	120pF	120pF	120pF	120pF	120pF	120pF	120pF	150pF	150pF	470pF	470pF	470pF
<b>16V</b>	5.6nF	39nF	27nF	100nF	120nF	270nF	470nF	560nF	1.0µF	1.8µF	1.5µF	2.2µF
<b>25V</b>	4.7nF	33nF	22nF	100nF	120nF	270nF	470nF	560nF	1.0µF	1.5µF	1.2µF	1.8µF
<b>50V</b>	1.8nF	18nF	12nF	47nF	68nF	120nF	270nF	270nF	560nF	1.2µF	1.2µF	1.5µF
<b>100V</b>	680pF	6.8nF	4.7nF	18nF	18nF	47nF	100nF	100nF	180nF	390nF	330nF	470nF
<b>200V</b>	220pF	1.8nF	1.2nF	5.6nF	8.2nF	15nF	27nF	33nF	56nF	100nF	82nF	120nF
<b>250V</b>	-	680pF	390pF	1.8nF	2.7nF	4.7nF	10nF	10nF	22nF	56nF	47nF	68nF
<b>300V</b>	-	-	-	1.2nF	1.2nF	3.2nF	5.6nF	6.8nF	12nF	39nF	33nF	47nF
<b>400V</b>	-	-	-	680pF	680pF	1.8nF	3.3nF	3.9nF	5.6nF	18nF	18nF	22nF
<b>500V</b>	-	-	-	390pF	470pF	1.0nF	2.2nF	2.2nF	3.9nF	12nF	10nF	15nF



# Improved ESR Capacitors - BX & X7R

A range of commercial MLC chip capacitors with improved ESR performance. This series has been designed for rugged environments in high power broadband coupling and switching power supplies. The Class II ceramic dielectric (BX or X7R dependant on chip size) affords high volumetric efficiency with negligible piezoelectric effects.

Please consult the Novacap Sales Office if your specific requirement exceeds our catalog maximums (size, capacitance value and voltage).

- For dimensions see page 20.
- Termination options:
  - P = Palladium/Silver
  - N = Nickel barrier 100% Tin (RoHS)
  - Y = Nickel barrier 90% Tin/10% Lead
  - B = Copper barrier 100% Tin (RoHS)
  - E = Copper barrier 90% Tin/10% Lead
- Capacitance tolerances available  $\pm 10\%$ ,  $\pm 20\%$
- For ordering information see page 22.

## Capacitance and Voltage Selection - BX & X7R - Improved ESR

Size	RF0505	RF1111	RF2525				
Tmax mm ~ inches:	0.057 ~ 1.45*	0.102 ~ 2.59*	0.165 ~ 4.19*				
Dielectric	BX	BX	X7R				
Rated Voltage	50	50	100	150	200	250	300
470pF	•						
560pF	•						
680pF	•						
820pF	•						
1.0nF	•						
1.2nF	•						
1.5nF	•						
1.8nF	•						
2.2nF	•						
2.7nF	•						
3.3nF	•						
3.9nF	•						
4.7nF	•	•					
5.0nF	•	•					
5.6nF	•	•					
6.8nF	•	•					
8.2nF	•	•					
10nF	•	•					•
12nF		•					•
15nF		•					•
18nF		•					•
22nF		•					•
27nF		•					
33nF		•				•	
39nF		•				•	
47nF		•				•	
50nF		•					
56nF		•					
68nF		•					•
82nF		•			•		
100nF		•			•		
120nF					•		
150nF					•		
220nF					•		
330nF				•			
470nF				•			
560nF				•			
680nF				•			
820nF			•				
1.0µF			•				

Note: \*Denotes non standard chip thickness. Order code needs to have an 'X' inserted together with the dimension in inches e.g. X057 where dimension is 0.057"

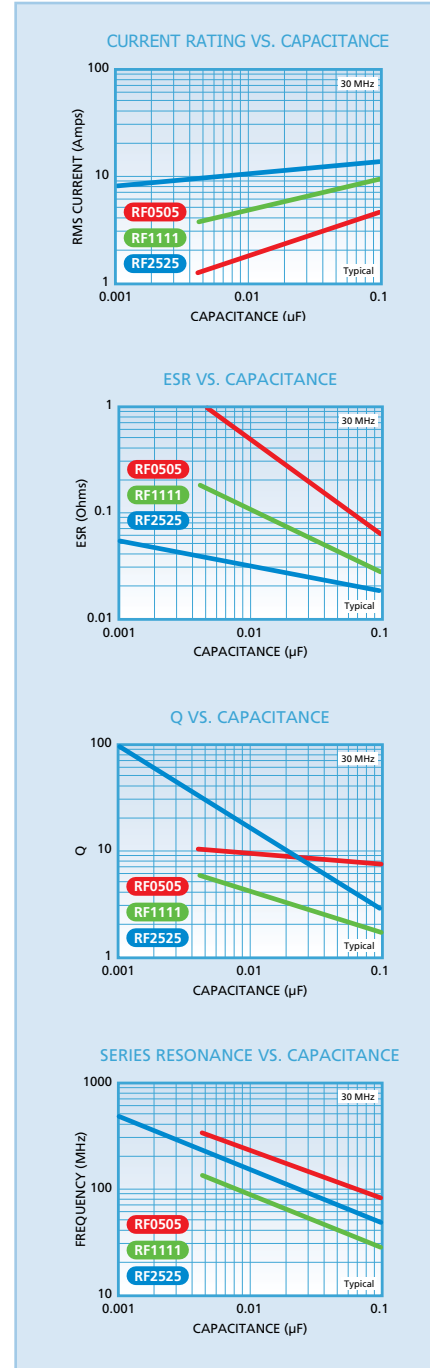

# High Q Capacitors - Q(MS) & U ranges

The "Q(MS)" and "U" ranges offers a very stable High Q material system that provides excellent, low loss, performance in systems below 3GHz. Optimised for lowest possible ESR, this range of high frequency capacitors is suitable for many applications where economical, high performance is required.

Available in 0402 to 3640 case sizes (0603 & 0805 case sizes only available in the "U" range) with various termination options including FlexiCap™.

CapCad™ capacitor modelling software is now available and has been developed with an easy to use and readily accessible comparison tool for choosing the best MLCC to suit the customer's needs. Please consult the Knowles website to launch the software.

## Operating Temperature

-55°C to +125°C

## Temperature Coefficient (Typical)

0 ± 30 ppm/°C (COG/NP0)

## Insulation resistance

MS range: >100GΩ at +25°C; >10GΩ +125°C

U range: 100GΩ or 1000s (whichever is the least)

## Q Factor

>2000 @ 1MHz



0603 S-parameter downloads are available from:

<http://www.knowlescapacitors.com/syfer/en/products/mlc-capacitors/ultra-low-esr-capacitors> and the Syfer MVP page on

the Modelithics website. Please visit the Syfer MVP page for more

information at: <http://www.modelithics.com/mvp/syfer>

## Minimum/maximum capacitance values - Q(MS) & U ranges - High Q capacitors

Chip Size	0402*	0603†	0505	0805†	1206	1111	1210	1812	2220	2225	4040
Min Cap	0.1pF	0.1pF	0.2pF	0.2pF	0.5pF	0.3pF	0.3pF	1.0pF	2.0pF	-	-
50V <sub>63V</sub>	33pF	-	330pF	-	2.2nF	-	-	-	-	-	-
100V	22pF	-	220pF	-	1.5nF	3.3nF	3.3nF	6.8nF	15nF	-	-
150V	22pF	-	180pF	-	1.2nF	2.7nF	2.7nF	4.7nF	12nF	-	-
200V <sub>250V</sub>	22pF	100pF	150pF	240pF	1.0nF	2.2nF	2.2nF	3.9nF	10nF	6.2 - 10nF	16 - 27nF
300V	-	-	100pF	-	680pF	1.5nF	1.5nF	3.3nF	6.8nF	-	-
500V	-	-	-	-	330pF	820pF	820pF	2.2nF	4.7nF	5.1 - 5.6nF	13 - 15nF
630V	-	-	-	-	150pF	390pF	390pF	1.0nF	2.2nF	3.6 - 4.7nF	11 - 12nF
1000V	-	Below 1pF capacitance values are available in 0.1pF steps ~ above 1pF capacitance values are available in E24 series values.		-	82pF	220pF	220pF	680pF	1.5nF	1.1 - 3.3nF	5.6 - 10nF
2000V	-			-	18pF	68pF	68pF	150pF	470pF	510pF - 1.0nF	1.6 - 5.1nF
3000V	-			-	-	-	-	68pF	150pF	1.0 - 470pF	910pF - 1.5nF
4000V	-			-	-	-	-	-	-	-	620 - 820pF
5000V	-			-	-	-	-	-	-	-	360 - 560pF
6000V	-			-	-	-	-	-	-	-	160 - 330pF
7000/7200V	-			-	-	-	-	-	-	-	1.0 - 150pF
Tape quantities	7" reel 10000	7" reel 4000	7" reel 2500	7" reel 3000	7" reel 2500	7" reel 1000	7" reel 2000	7" reel 500 13" reel 2000	7" reel 500 13" reel 2000	7" reel 500 13" reel 2000	13" reel only
	13" reel quantities available on request										

\*0402 size and other values (inc. values < than 0.3pF) and taping quantities may be available on request, consult the Sales Office.

†0603 and 0805 sizes only available in the "U" range and not Q(MS)

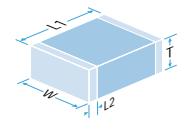

## Dimensions

Range	Case Size	Length (L1) mm ~ inches	Width (W) mm ~ inches	Max. Thickness (T) mm ~ inches	Termination Band (L2) mm ~ inches	
					Min	Max
MS	0402	1.0 ± 0.10 ~ 0.04 ± 0.006	0.50 ± 0.10 ~ 0.02 ± 0.003	0.60 ~ 0.031	0.10 ~ 0.004	0.40 ~ 0.015
U	0603	1.6 ± 0.2 ~ 0.063 ± 0.008	0.8 ± 0.2 ~ 0.032 ± 0.008	0.80 ~ 0.032	0.10 ~ 0.004	0.40 ~ 0.016
MS	0505	1.4 +0.35 -0.25 ~ 0.055 +0.014 -0.01	1.4 ± 0.25 ~ 0.055 ± 0.01	1.27 ~ 0.05	0.13 ~ 0.005	0.5 ~ 0.02
U	0805	2.0 ± 0.3 ~ 0.079 ± 0.012	1.25 ± 0.20 ~ 0.049 ± 0.008	1.3 ~ 0.051	0.13 ~ 0.005	0.75 ~ 0.03
MS	1206	3.2 ± 0.3 ~ 0.126 ± 0.012	1.6 ± 0.20 ~ 0.063 ± 0.008	1.6 ~ 0.063	0.25 ~ 0.01	0.75 ~ 0.03
MS	1111	2.79 +0.51 -0.25 ~ 0.11 +0.02 -0.01	2.79 ± 0.38 ~ 0.113 ± 0.015	1.78 ~ 0.07	0.13 ~ 0.005	0.63 ~ 0.025
MS	1210	3.2 ± 0.3 ~ 0.126 ± 0.012	2.5 ± 0.3 ~ 0.10 ± 0.012	2.0 ~ 0.08	0.25 ~ 0.01	0.75 ~ 0.03
MS	1812	4.5 ± 0.35 ~ 0.18 ± 0.014	3.2 ± 0.3 ~ 0.126 ± 0.012	2.5 ~ 0.10	0.25 ~ 0.01	1.0 ~ 0.04
MS	2220	5.7 ± 0.40 ~ 0.225 ± 0.016	5.0 ± 0.40 ~ 0.197 ± 0.016	4.2 ~ 0.16	0.25 ~ 0.01	1.0 ~ 0.04
MS	2225	5.7 ± 0.40 ~ 0.225 ± 0.016	6.30 ± 0.40 ~ 0.252 ± 0.016	4.2 ~ 0.165	0.381 ~ 0.01	1.143 ~ 0.045
MS	4040	10.2 ± 0.508 ~ 0.400 ± 0.020	10.2 ± 0.508 ~ 0.400 ± 0.020	7.62 ~ 0.30	0.50 ~ 0.02	1.50 ~ 0.06

# High Q Capacitors - Q(MS) & U ranges

Q(MS) Series - Impedance vs. Frequency - Case size 0505

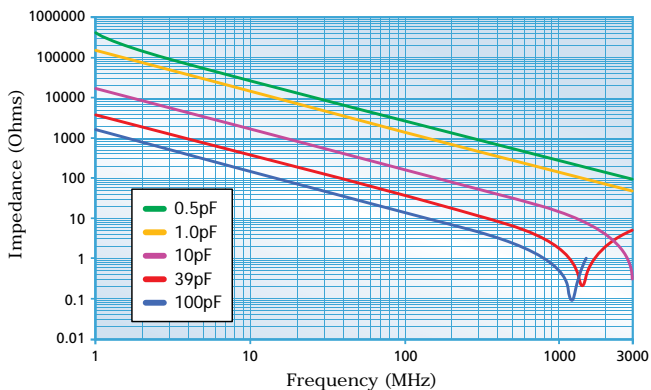

Q(MS) Series - Impedance vs. Frequency - Case size 1111

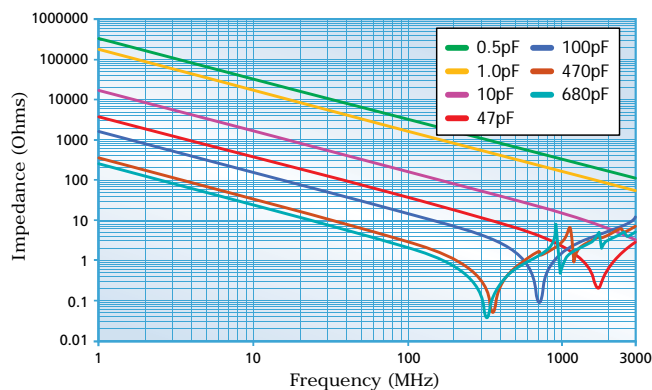

Q(MS) Series - ESR vs. Frequency - Case size 0505

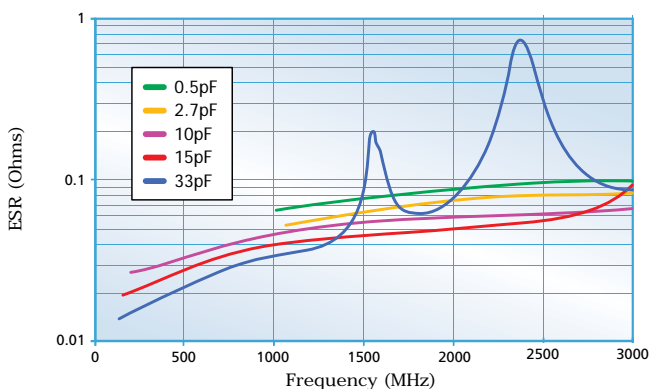

Q(MS) Series - ESR vs. Frequency - Case size 1111

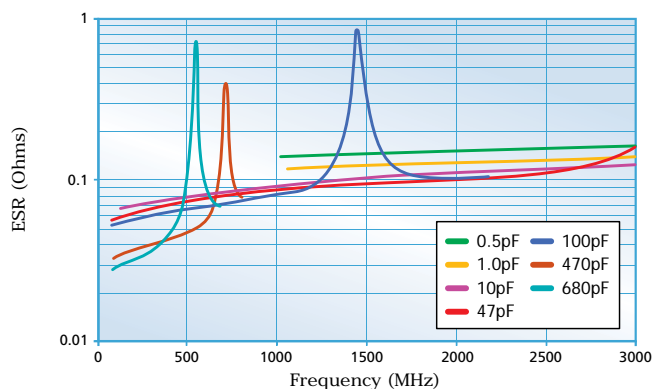

Q(MS) Series Q vs. Frequency - Case size 0505

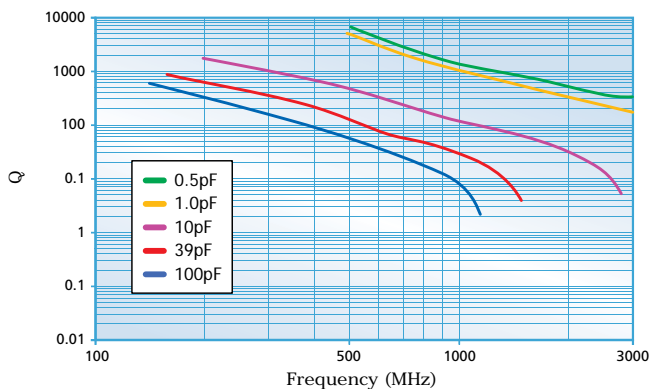

Q(MS) Series Q vs. Frequency - Case size 1111

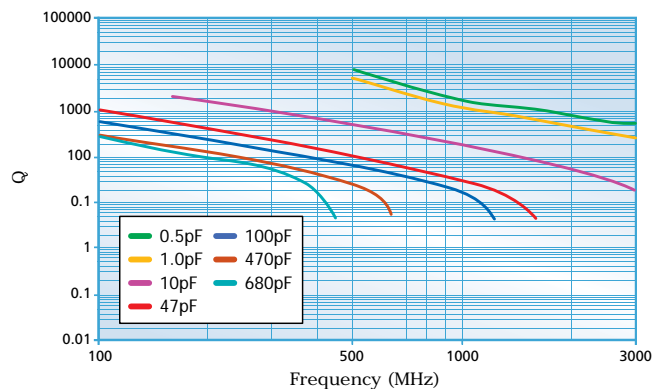

All performance curves are based on measurements taken with Boonton 34A resonant tube, Agilent E4991A impedance analyser and Agilent 16197A test fixture. Different test methods or fixtures may give different results. Data is typical and is supplied for indication only.



# High Q Capacitors - Q(MS) & U ranges



U Series - Impedance vs. Frequency - Case size 0603

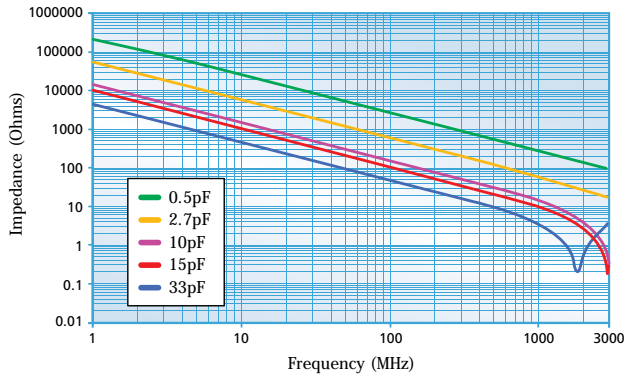

U Series - Impedance vs. Frequency - Case size 0805

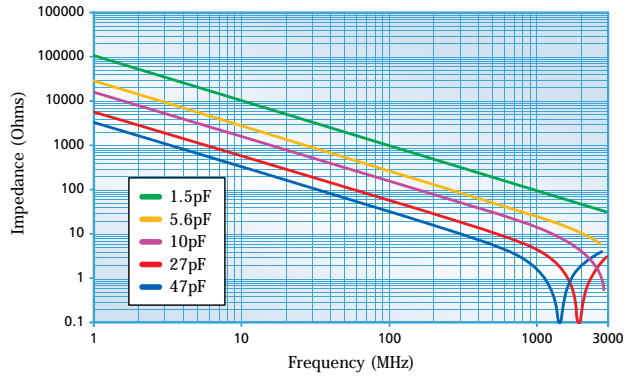

U Series - ESR vs. Frequency - Case size 0603

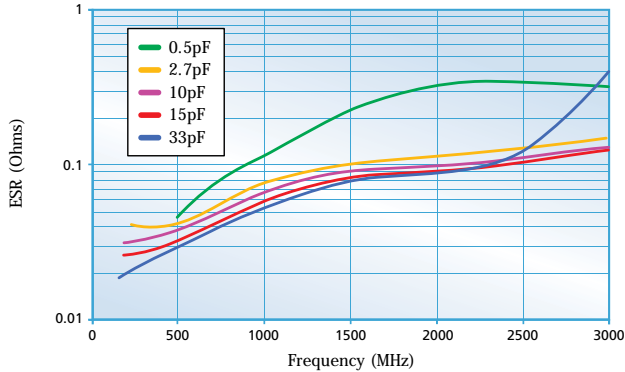

U Series - ESR vs. Frequency - Case size 0805

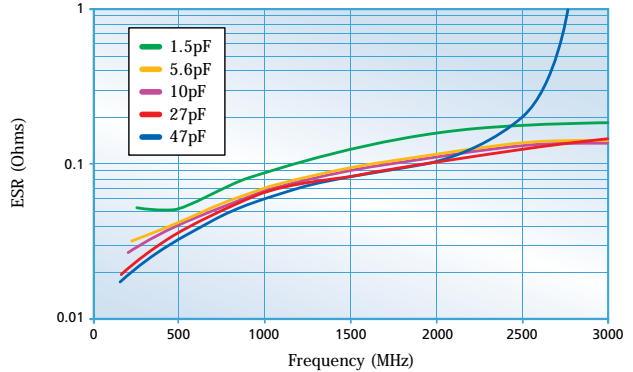

U Series Q vs. Frequency - Case size 0603

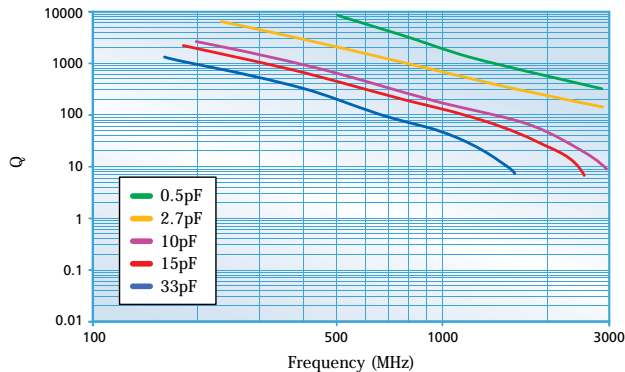

U Series Q vs. Frequency - Case size 0805

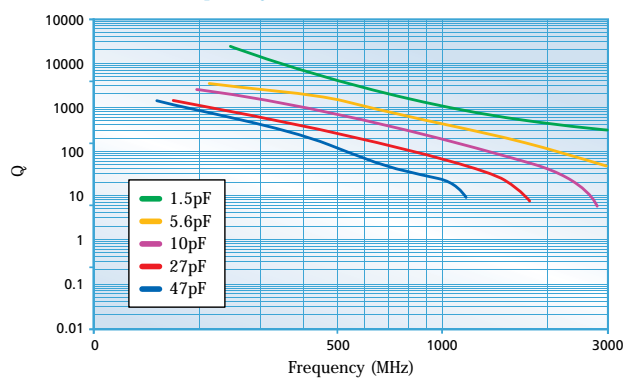

Note: All performance curves are based on measurements taken with Boonton 34A resonant tube, Agilent E4991A impedance analyser and Agilent 16197A test fixture. Different test methods or fixtures may give different results. Data is typical and is supplied for indication only.

\*0402 size and other values (inc. values < than 0.3pF) and taping quantities may be available on request, consult the Sales Office.

†0603 and 0805 sizes only available in the "U" range and not Q(MS).

## Ordering information - High Q capacitors - MS(Q) and U ranges

0805	J	250	4P70	B	U	T
Chip size	Termination	Voltage	Capacitance in picofarads (pF)	Capacitance tolerance	Dielectric	Packaging
0402* 0603† 0505 0805† 1206 1111 1210 1812 2220 2225 3640	J = Nickel barrier (100% matte tin plating). RoHS compliant. Lead free. A = Nickel barrier (Tin/lead plating with min. 10% lead). Not RoHS compliant.	050 = 50V 063 = 63V 100 = 100V 150 = 150V 200 = 200V 250 = 250V 300 = 300V 500 = 500V 630 = 630V 1K0 = 1kV 2K0 = 2kV 3K0 = 3kV	<1.0pF: Insert a P for the decimal point as the first character. eg. P300 = 0.3pF Values in 0.1pF steps ≥1.0pF & <10pF: Insert a P for the decimal point as the second character. eg. 8P20 = 8.2pF Values are E24 series ≥10pF: First digit is 0. Second and third digits are significant figures of capacitance code. Fourth digit is number of zeros. eg. 0101 = 100pF Values are E24 series	<4.7pF H = ±0.05pF B = ±0.1pF C = ±0.25pF D = ±0.5pF <10pF B = ±0.1pF C = ±0.25pF D = ±0.5pF ≥10pF F = ±1% G = ±2% J = ±5% K = ±10%	Q = High Q version of COG/NPO U = High Q version of COG/NPO	T = 178mm (7") reel R = 330mm (13") reel B = Bulk pack - tubs or trays

# High Q Capacitors, High Temperature - H range

The Ultra-low ESR "H" range offers a very stable, X8G High Q material system that provides excellent low loss performance. Optimised for lowest possible ESR, the electrode system provides low metal losses resulting in flatter performance curves and reduced losses at higher frequencies.

An extended operating temperature range of -55°C to +150°C accommodates modern high density micro electronics requirements.

This range of high frequency capacitors is suitable for many applications where economical, high performance is required.

## Operating Temperature

-55°C to +150°C (EIA X8G)

## Temperature Coefficient (Typical)

0 ± 30 ppm/°C (EIA X8G)

## Insulation resistance

Time constant (Ri xCr) (whichever is the least)

100GΩ or 1000s

## Q Factor

>2000 @ 1MHz



## Minimum/maximum capacitance values - Ultra-low ESR capacitors - H range

Chip Size		0402	0603	0805
Min Cap		0.1pF	0.1pF	0.2pF
Max Cap	250V	22pF	100pF	240pF
Tape quantities		7" reel - 10,000	7" reel - 4,000	7" reel - 3,000
		13" reel - 15,000	13" reel - 16,000	13" reel - 12,000

Note: Below 1pF capacitance values are available in 0.1pF steps. Above 1pF capacitance values are available in E24 series values.

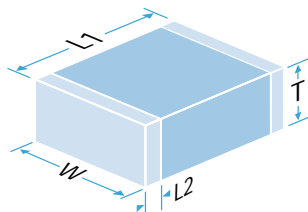

## Dimensions

Size	Length (L1) mm ~ inches	Width (W) mm ~ inches	Max. Thickness (T) mm ~ inches	Termination Band (L2) mm ~ inches	
				min	max
0402	1.0 ± 0.10 ~ 0.04 ± 0.004	0.5 ± 0.1 ~ 0.02 ± 0.004	0.60 ~ 0.24	0.10 ~ 0.004	0.40 ~ 0.016
0603	1.6 ± 0.2 ~ 0.063 ± 0.008	0.8 ± 0.2 ~ 0.032 ± 0.008	0.80 ~ 0.032	0.10 ~ 0.004	0.40 ~ 0.016
0805	2.0 ± 0.3 ~ 0.079 ± 0.012	1.25 ± 0.20 ~ 0.049 ± 0.008	1.3 ~ 0.051	0.13 ~ 0.005	0.75 ~ 0.03

## Ordering information - Ultra-low ESR capacitors - H range

0805	J	250	0101	J	H	T
Chip size	Termination	Voltage	Capacitance in picofarads (pF)	Capacitance tolerance	Dielectric	Packaging
0402 0603 0805	J = Nickel barrier (100% matte tin plating). RoHS compliant. Lead free.	250 = 250V	<1.0pF: Insert a P for the decimal point as the first character. eg. P300 = 0.3pF Values in 0.1pF steps ≥1.0pF & <10pF: Insert a P for the decimal point as the second character. eg. 8P20 = 8.2pF Values are E24 series ≥10pF: First digit is 0. Second and third digits are significant figures of capacitance code. Fourth digit is number of zeros. eg. 0101 = 100pF Values are E24 series	<4.7pF H = ±0.05pF B = ±0.1pF C = ±0.25pF D = ±0.5pF <10pF B = ±0.1pF C = ±0.25pF D = ±0.5pF ≥10pF F = ±1% G = ±2% J = ±5% K = ±10%	H = Ultra-low ESR High Frequency "H" range	T = 178mm (7") reel R = 330mm (13") reel B = Bulk pack - tubs or trays

# High Q Capacitors, High Temperature - H range

Typical performance - 0603 chip size

Typical performance - 0805 chip size



0603 H Series Impedance vs. Frequency

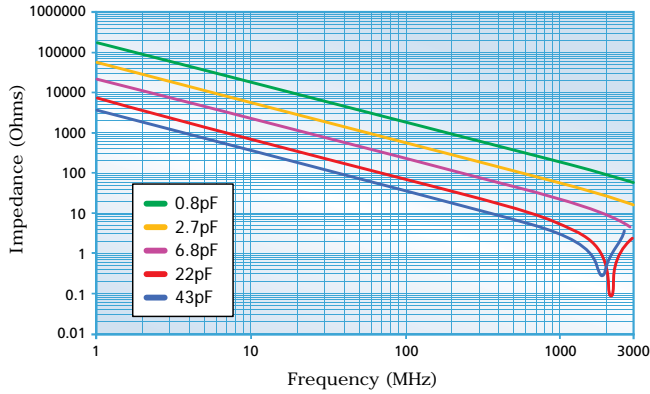

0805 H Series Impedance vs. Frequency

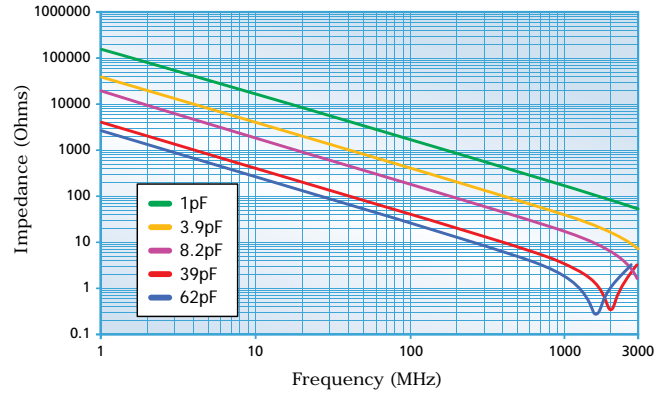

0603 H Series ESR vs. Frequency

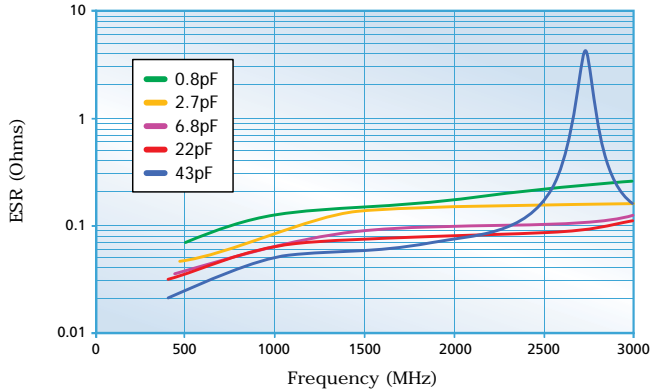

0805 H Series ESR vs. Frequency

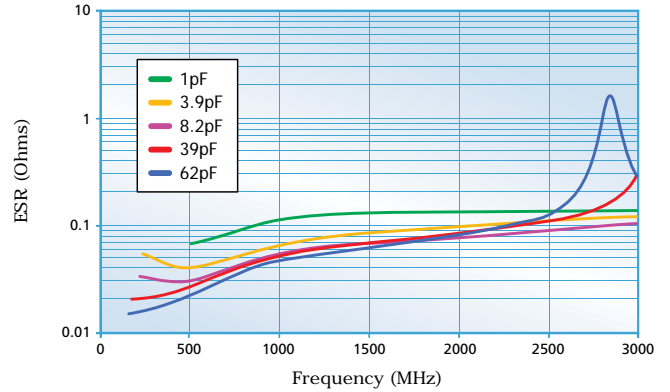

0603 H Series Q vs. Frequency

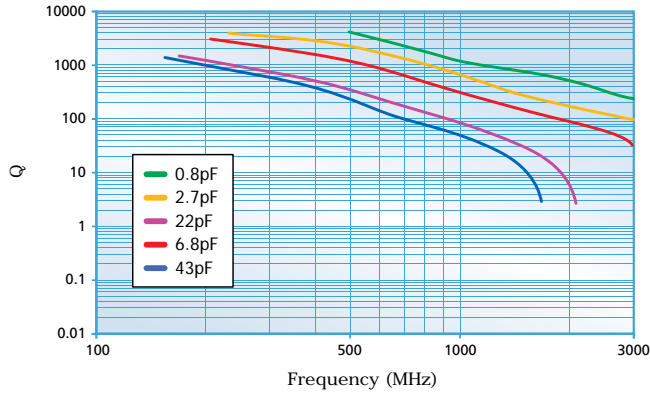

0805 H Series Q vs. Frequency

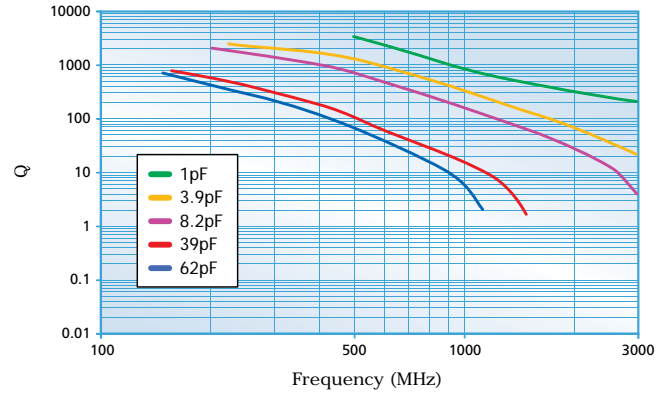



# High Q Capacitors, High Power RF - Surface Mount & Ribbon Leaded

A range of ultra-low loss High Q ceramic capacitors with COG/NPO characteristics suitable for high power applications where minimal power loss and very low self heating is demanded.

## Capacitance values

1pF to 27nF (High Q)

## Chip sizes

2225 and 4040

## Operating temperature

-55°C to +125°C

## High Q low ESR dielectrics

(other options available)

## Insulation Resistance (IR)

100GΩ min @ 100 Vdc or 1000s (whichever is the less)

DWV up to 8400Vdc



Typical ESR vs Frequency

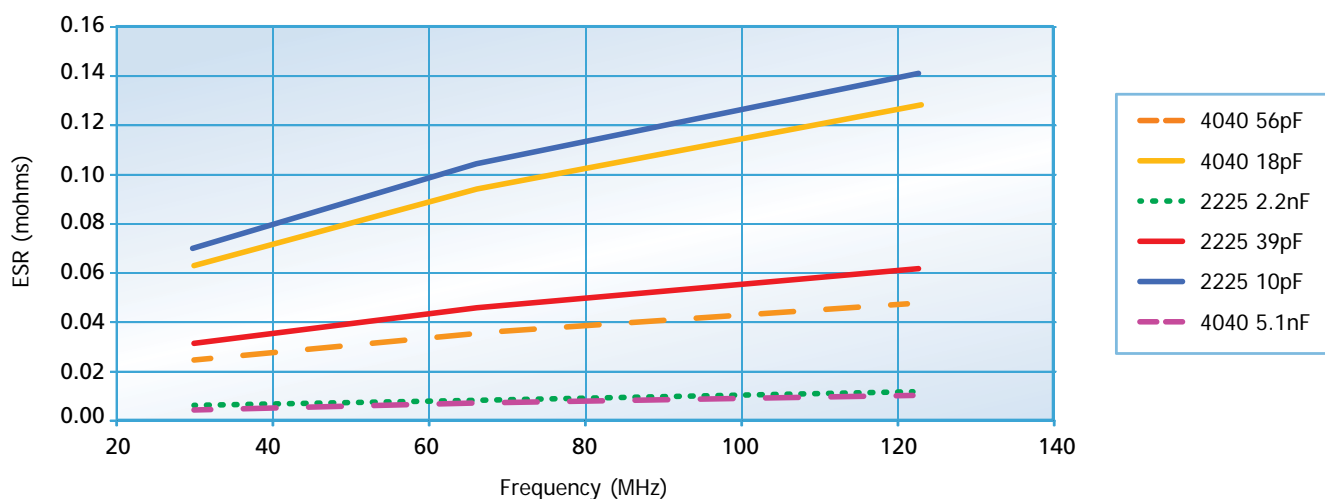

## ESR Measurement

All ESR figures are measured using a VNA and 2m copper resonant tube and extrapolating to 30MHz by ratio. Measured data can be supplied on request. Measurement of ESR can vary with test method and components should only be compared when tested back-to-back on the same equipment under controlled conditions.

## High Power RF capacitors - minimum/maximum capacitance values

Chip size	Case size 25 - 2225		Case size 40 - 4040	
	Min.	Max.	Min.	Max.
200V	6.2nF	10nF	16nF	27nF
500V	5.1nF	5.6nF	13nF	15nF
630V	3.6nF	4.7nF	11nF	12nF
1kV	1.1nF	3.3nF	5.6nF	10nF
2kV	510pF	1.0nF	1.6nF	5.1nF
3kV	110pF	470pF	910pF	1.5nF
3.6kV	1pF	47pF*/100pF	-	-
4kV	-	-	620pF	820pF
5kV	-	-	360pF	560pF
6kV	-	-	160pF	330pF
7.0kV/7.2kV	-	-	1pF	56pF** / 150pF

Note: \*2225 - 47pF max. for dual rated @2.5kVac 30MHz \*\*4040 - 56pF max. for dual rated @5kVac 30MHz.

# High Q Capacitors, High Power RF - Surface Mount & Ribbon Leded

## Surface Mount

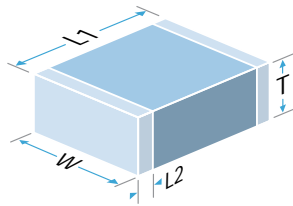

Plating finish:  
Tin over Ni.

## Ribbon Leded Silver plated copper ribbon attached with HMP solder - (MP greater than 260°C)

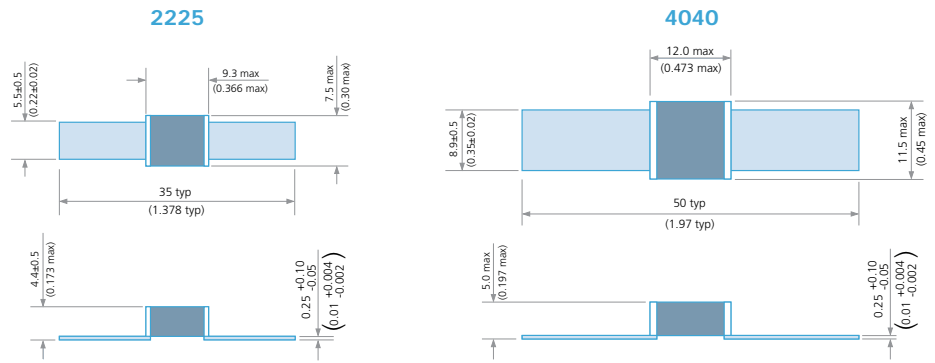

## Range dimensions - Surface Mount High Power RF capacitors

Chip size	Length (L1) mm/inches	Width (W) mm/inches	Max. Thickness (T) mm/inches	Termination Band L2 mm/inches	
				min	max
2225	5.7 ± 0.04 0.225 ± 0.016	6.3 ± 0.4 0.25 ± 0.016	4.2 0.16	0.25 0.01	1.0 0.04
4040	10.2 ± 0.5 0.402 ± 0.020	10.2 ± 0.5 0.402 ± 0.020	4.2 0.16	0.5 0.02	1.5 0.06

## Ordering information - Surface Mount High Power RF capacitors

4040	J	7K0	0470	J	Q	B	AF7
Chip size	Termination	Voltage	Capacitance in picofarads (pF)	Capacitance tolerance	Dielectric	Packing	Variant Code
2225 4040	J = Nickel barrier (100% matte tin plating). RoHS compliant. Lead free.	200 = 200V 500 = 500V 630 = 630V 1K0 = 1kV 2K0 = 2kV 3K0 = 3kV 3K6 = 3.6kV 4K0 = 4kV 5K0 = 5kV 6K0 = 6kV 7K0 = 7kV/ 7.2kV	<10pF Insert a P for the decimal point, eg 2P20 = 2.2pF. >10pF. 1st digit is 0. 2nd and 3rd digits are significant figures of capacitance code. The 4th digit is number of 0's following eg. 0470 = 47pF 0512 = 5100pF	<10pF B = ±0.10pF C = ±0.25pF D = ±0.50pF ≥10pF G = ±2% J = ±5% K = ±10% M = ±20%	Q = High Q version of COG/NPO	B = Bulk packed	AF7 = Standard Variant for High Power applications

## Ordering information - Ribbon Leded High Power RF capacitors

4040	B	7K0	0470	G	Q	B	Lead options	Variant code
Chip size	Coating	Voltage	Capacitance in picofarads (pF)	Capacitance tolerance	Dielectric	Packing	R	W001
2225 4040	B = Uncoated V = Coated with modified silicone lacquer	200 = 200V 500 = 500V 630 = 630V 1K0 = 1kV 2K0 = 2kV 3K0 = 3kV 3K6 = 3.6kV 4K0 = 4kV 5K0 = 5kV 6K0 = 6kV 7K0 = 7kV/ 7.2kV	<10pF Insert a P for the decimal point, eg 2P20 = 2.2pF. >10pF. 1st digit is 0. 2nd and 3rd digits are significant figures of capacitance code. The 4th digit is number of 0's following eg. 0470 = 47pF 0512 = 5100pF	<10pF B = ±0.10pF C = ±0.25pF D = ±0.50pF ≥10pF G = ±2% J = ±5% K = ±10% M = ±20%	Q = High Q version of COG/NPO	B = Bulk packed	R = Ribbon Leded	W001 = Standard Variant W**1 = Marked

Note: For non-magnetic see page 69.

# High Q Porcelain Capacitors - CF Series

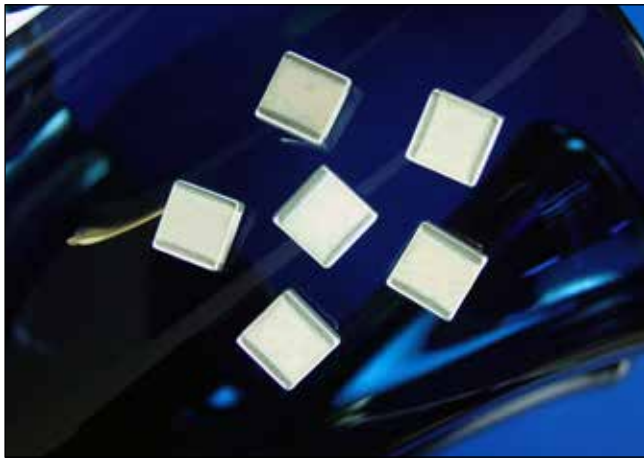

## Description

- High Q Porcelain Capacitors • SMD Compatibility
- Ultra Temperature Stable • Low ESR, High Q
- Capacitance range 0.1 - 5100 pF
- Operating Range -55° to +125°C • High Voltage
- High Self-resonance • Low Noise • Established Reliability

## Functional Applications

- Impedance Matching • Power Handling • DC Blocking
- Bypass • Coupling • Tuning and Feedback
- Amplifier Matching Networks • VCO Frequency Stabilization
- Filtering, Duplexers and Antenna Matching
- High RF Power Circuits • Oscillators • Timing Circuits
- Filters • RF Power Amplifiers and Delay Lines

## Dielectric characteristics

Dielectric Material (Code)	COG/NP0 (CF)	
Temperature Coefficient (ppm/°C )	0 ± 15	
Dissipation Factor (% @ 1MHz Maximum)	0.05	
Dielectric Withstanding Voltage	Voltage Rating (Volts)	Refer to table
	DWV (Volts)	250% of rated
Insulation Resistance (MΩ Minimum)	@ +25°C	10 <sup>6</sup> MΩ min
	@ +125°C	10 <sup>5</sup> MΩ min
Ageing	None	
Piezoelectric Effects	None	
Dielectric Absorption	None	

Capacitance and Voltage Table

Cap Code	Cap (PF)	Case Size					
		C06 0603	C11 0505	C17 1111	C18 1111	C22 2225	C40 3838
OR1	0.1	250V Code 9	250V Code 9	1kV Code 7	2kV Code G	2.5kV Code B	7.2kV Code H
OR2	0.2						
OR3	0.3						
OR4	0.4						
OR5	0.5						
OR6	0.6						
OR7	0.7						
OR8	0.8						
OR9	0.9						
1R0	1.0						
1R1	1.1						
1R3	1.3						
1R4	1.4						
1R5	1.5						
1R6	1.6						
1R7	1.7						
1R8	1.8						
1R9	1.9						
2R0	2.0						
2R1	2.1						
2R2	2.2						
2R4	2.4						
2R7	2.7						
3R0	3.0						
3R3	3.3						
3R6	3.6						
3R9	3.9						
4R3	4.3						
4R7	4.7						
5R1	5.1						
5R6	5.6						
6R2	6.2						
6R8	6.8						
7R5	7.5						
8R2	8.2						
9R1	9.1						
100	10						
110	11						
120	12						
130	13						
150	15						
160	16						
180	18						
200	20						
220	22						
240	24						
270	27						
300	30						
330	33						
360	36						
390	39						
430	43						
470	47						
510	51						
560	56						
620	62						
680	68						
750	75						
820	82						
910	91						
101	100						
111	110						
121	120						
131	130						
151	150						
161	160						
181	180						
201	200						
221	220						
241	240						
271	270						
301	300						
331	330						
361	360						
391	390						
431	430						
471	470						
511	510						
561	560						
621	620						
681	680						
751	750						
821	820						
911	910						
102	1000						
122	1200						
152	1500						
182	1800						
222	2200						
272	2700						
332	3300						
392	3900						
472	4700						
512	5100						
Reel QTY		4000	3500	2350	2350	500	250

Special capacitance values available upon request.

# High Q Porcelain Capacitors - CF Series

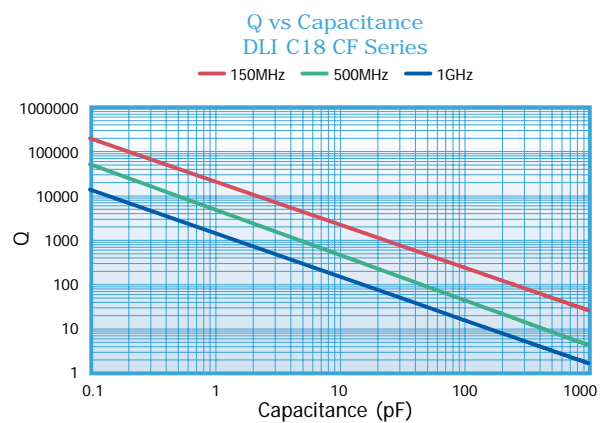
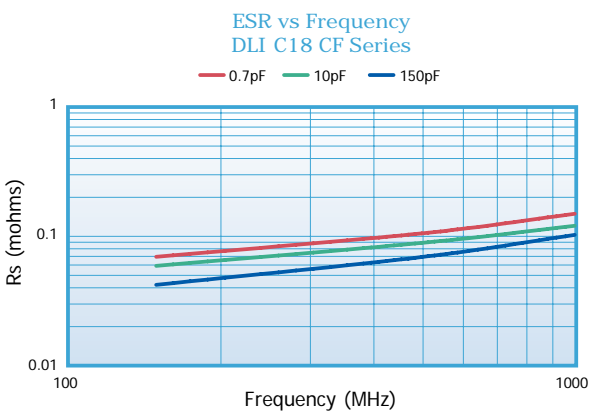
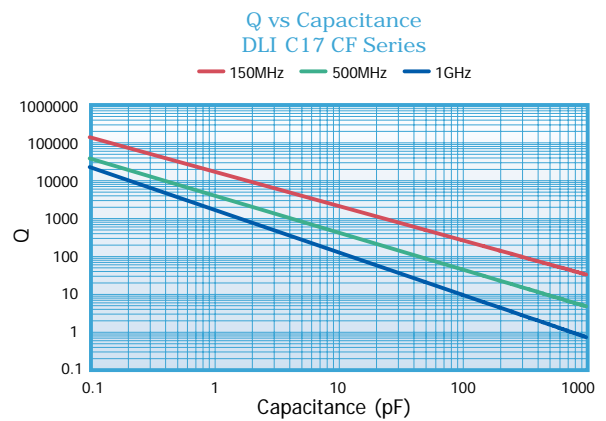
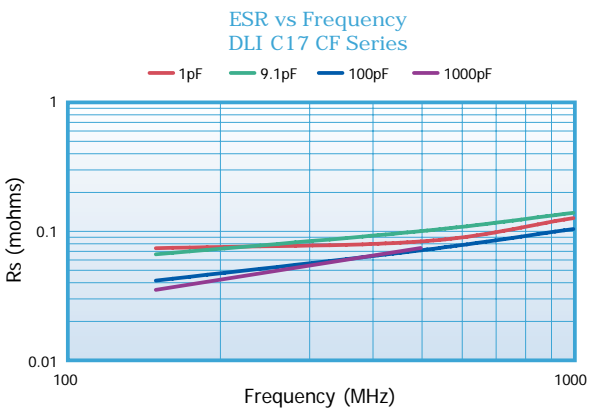
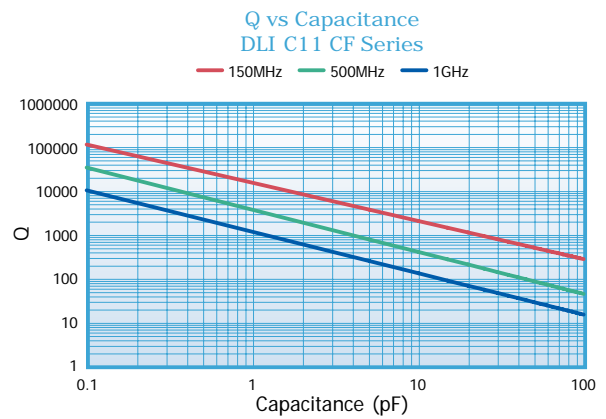
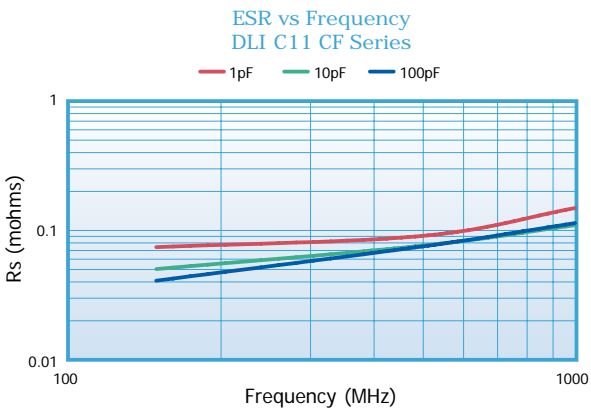
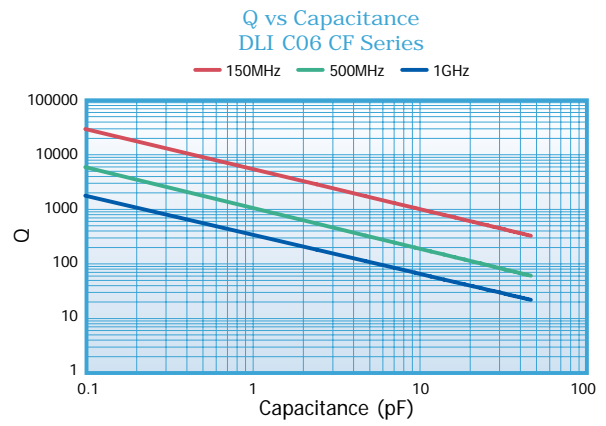
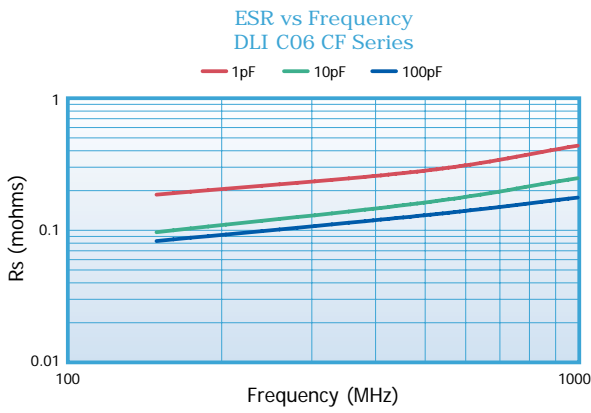

Note: This information represents typical device performance.

# High Q Porcelain Capacitors - CF Series

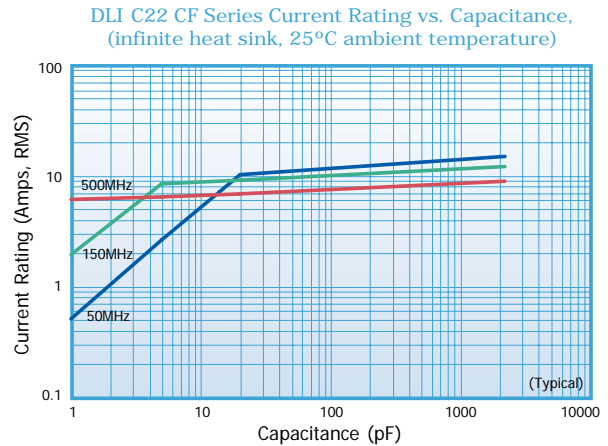
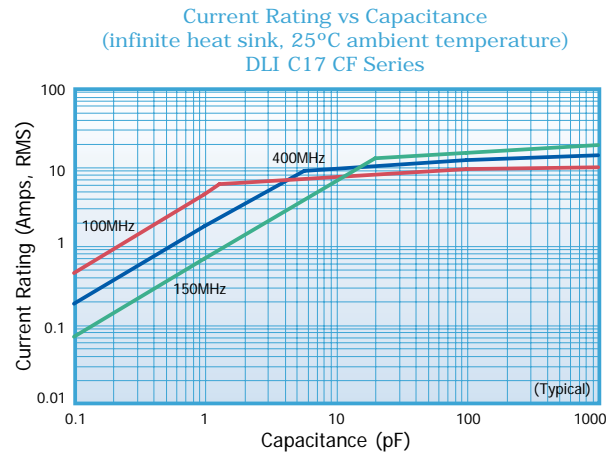
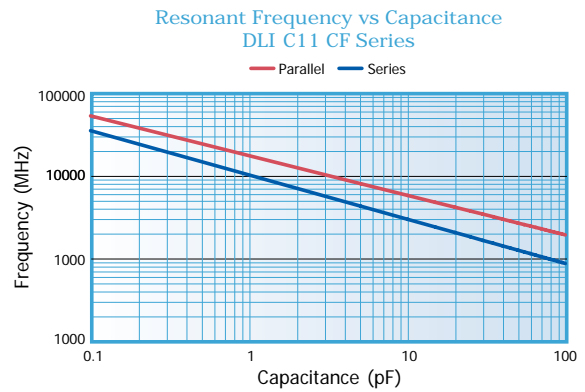
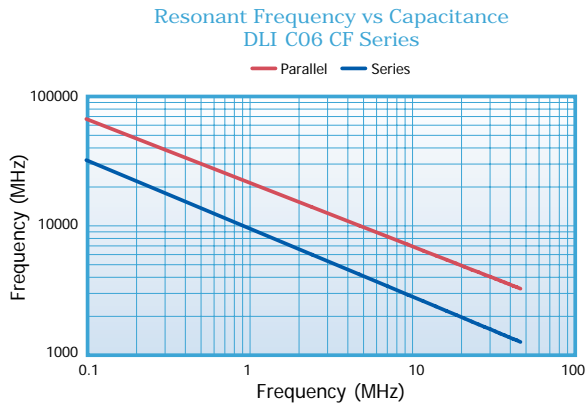
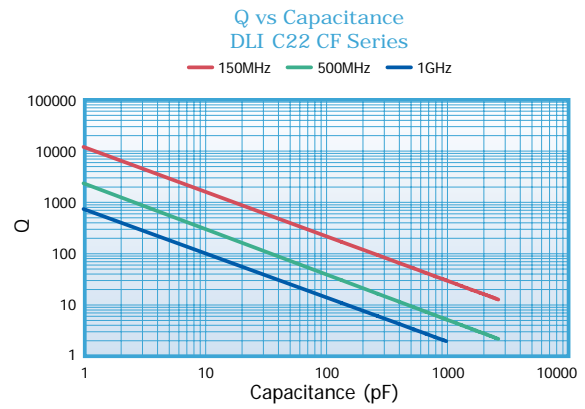
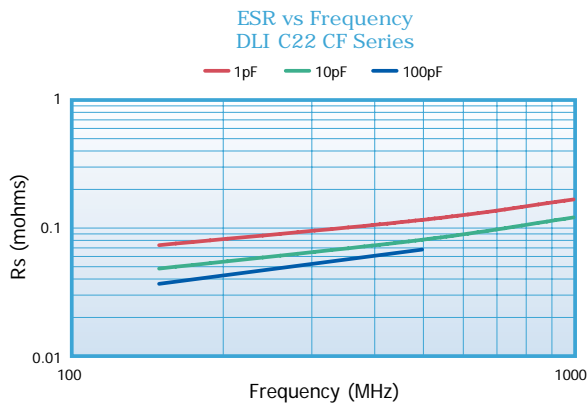

Note: This information represents typical device performance.

Ordering information - CF Series - See Page 21 for complete part number system.

C17	CF	620	J	-	7	U	N	-	X	0	T
Chip size	Dielectric	Capacitance Code (pF)	Capacitance tolerance		Voltage Code	Termination	Lead Type		Test Level	Marking	Packaging
C06 C11 C17 C18 C22 C40	CF = COG/NPO High Q	1 <sup>st</sup> two digits are significant figures of capacitance, 3 <sup>rd</sup> digit denotes number of zeros, R = decimal point.  Examples: 1R0 = 1.0pF 471 = 471pF	<10pF A = ±0.05pF B = ±0.1pF C = ±0.25pF D = ±0.5pF  ≥10pF F = ±1% G = ±2% J = ±5% K = ±10% M = ±20% X = GMV S = Special		5 = 50V 1 = 100V 6 = 200V 9 = 250V 4 = 500V 7 = 1kV A = 1.5kV G = 2kV B = 2.5kV D = 3.6kV H = 7.2kV	C06 U, S, Z, E, P, Q, Y, W, H, V, R  C11/17 T, U, S, Z, E, P, Q, Y, W, H, V, R  C18 U, Q, Y, V, W, H, Z  C22 U, S, Z, E, P, Q, Y, W, H, V, R  C40 T, U, S, P, Q, Y, W, H, V, R	A = Axial ribbon B = Radial ribbon C = Center ribbon D = Special E = Axial wire F = Radial wire N = Chip  Note: C06 only available as N (Chip)		X = Standard Y = Reduced Visual  A = MIL-PRF-55681 Group A C = MIL-PRF-55681 Group C D = Customer Specified	C06 0, 1, 2, 5 C11 0 C17 0, 1, 2, 5 C18/22/40 0, 1	C06 T, W, B, S C11/17/18 T, V, W, B, P, S C22 T, B, P, S C40 T, B, P, S, R

# High Q Porcelain Capacitors - AH Series



## Description

- High Q Porcelain Capacitors • SMD Compatibility
- Positive TC "P90" • Low ESR, High Q
- Capacitance range 0.1 - 5100 pF
- Operating Range -55° to +125°C • High Voltage
- High Self-resonance • Low Noise • Established Reliability

## Functional Applications

- Impedance Matching • Power Handling • DC Blocking
- Bypass • Coupling • Tuning and Feedback
- Amplifier Matching Networks • VCO Frequency Stabilization
- Filtering, Diplexers and Antenna Matching
- High RF Power Circuits • Oscillators • Timing Circuits
- Filters • RF Power Amplifiers and Delay Lines

## Dielectric characteristics

Dielectric Material (Code)	P90 (AH)	
Temperature Coefficient (ppm/°C )	+90 ± 20	
Dissipation Factor (% @ 1MHz Maximum)	0.05	
Dielectric Withstanding Voltage	Voltage Rating (Volts)	Refer to table
	DWV (Volts)	250% of rated
Insulation Resistance (MΩ Minimum)	@ +25°C	10 <sup>6</sup> MΩ min
	@ +125°C	10 <sup>5</sup> MΩ min
Ageing	None	
Piezoelectric Effects	None	
Dielectric Absorption	None	

## Capacitance and Voltage Table

Cap Code	Cap (PF)	Case Size				
		C11 0505	C17 1111	C18 1111	C22 2225	C40 3838
0R1	0.1	250V Code 9				
0R2	0.2					
0R3	0.3					
0R4	0.4					
0R5	0.5					
0R6	0.6					
0R7	0.7					
0R8	0.8					
0R9	0.9					
1R0	1.0					
1R1	1.1					
1R3	1.3					
1R4	1.4					
1R5	1.5					
1R6	1.6					
1R7	1.7					
1R8	1.8					
1R9	1.9					
2R0	2.0					
2R1	2.1					
2R2	2.2					
2R4	2.4					
2R7	2.7					
3R0	3.0					
3R3	3.3					
3R6	3.6					
3R9	3.9					
4R3	4.3					
4R7	4.7					
5R1	5.1					
5R6	5.6					
6R2	6.2					
6R8	6.8					
7R5	7.5					
8R2	8.2					
9R1	9.1					
100	10					
110	11					
120	12					
130	13					
150	15					
160	16					
180	18					
200	20					
220	22					
240	24					
270	27					
300	30					
330	33					
360	36					
390	39					
430	43					
470	47					
510	51					
560	56					
620	62					
680	68					
750	75					
820	82					
910	91					
101	100					
111	110					
121	120					
131	130					
151	150					
161	160					
181	180					
201	200					
221	220					
241	240					
271	270					
301	300					
331	330					
361	360					
391	390					
431	430					
471	470					
511	510					
561	560					
621	620					
681	680					
751	750					
821	820					
911	910					
102	1000					
122	1200					
152	1500					
182	1800					
222	2200					
272	2700					
332	3300					
392	3900					
472	4700					
512	5100					
Reel QTY Horizontal		3500	2350	2350	500	250

Special capacitance values available upon request.

# High Q Porcelain Capacitors - AH Series

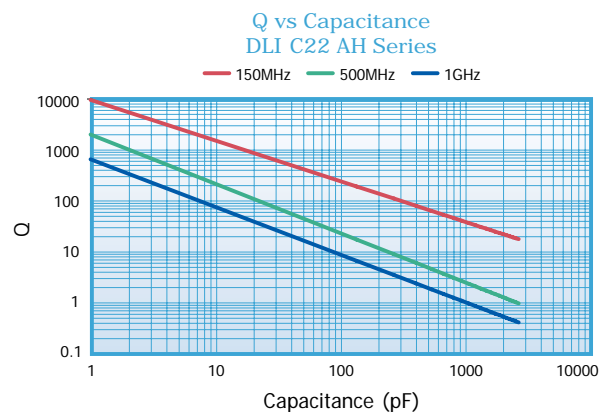
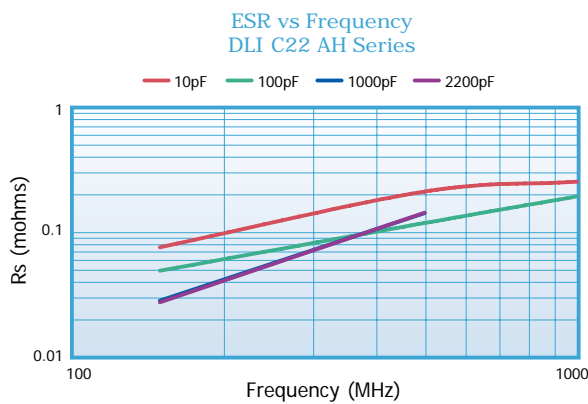
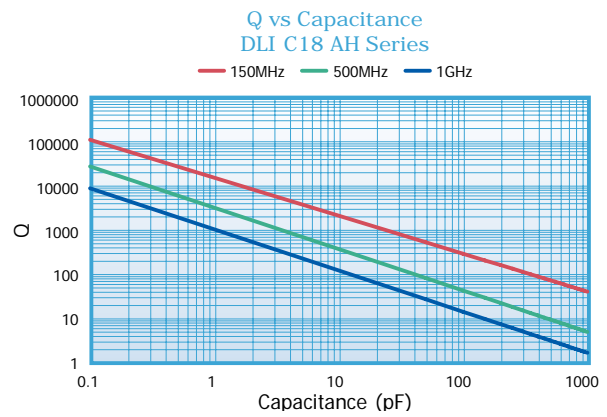
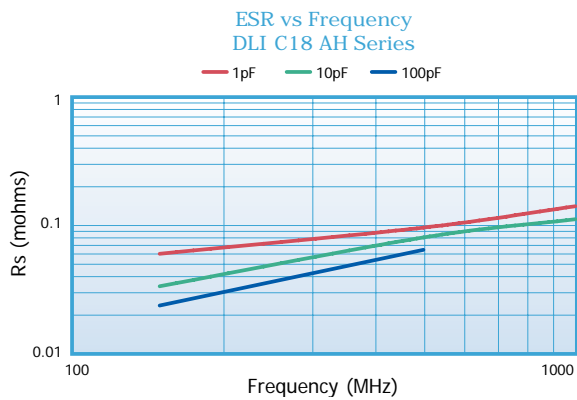
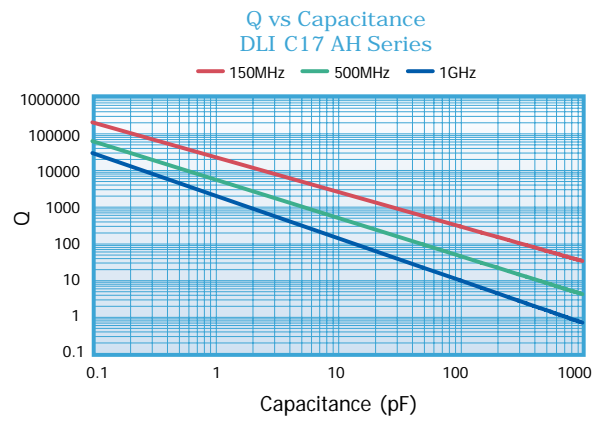
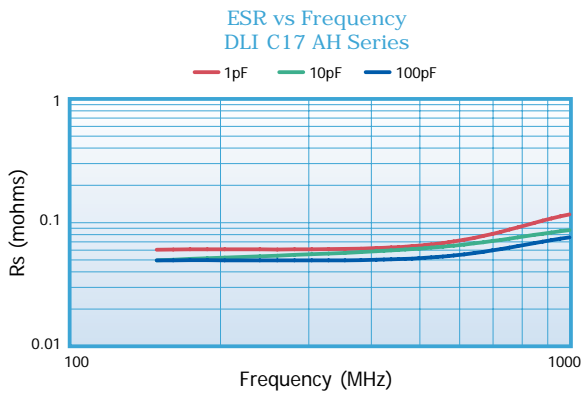
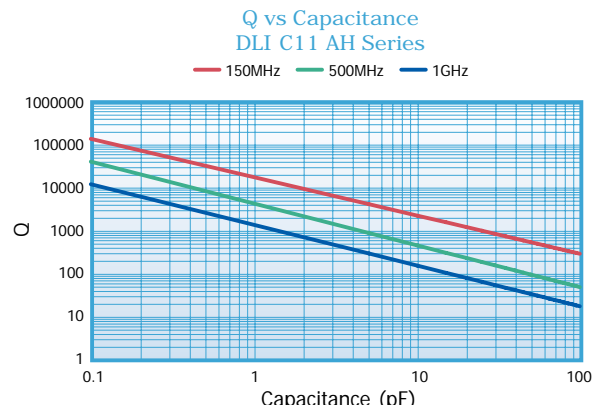
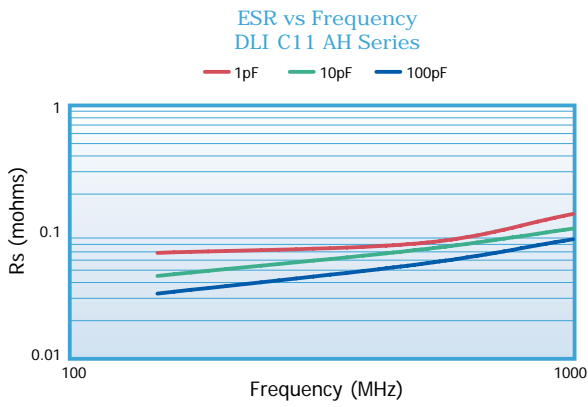

Note: This information represents typical device performance.

# High Q Porcelain Capacitors - AH Series



ESR vs Frequency  
DLI C40 AH Series

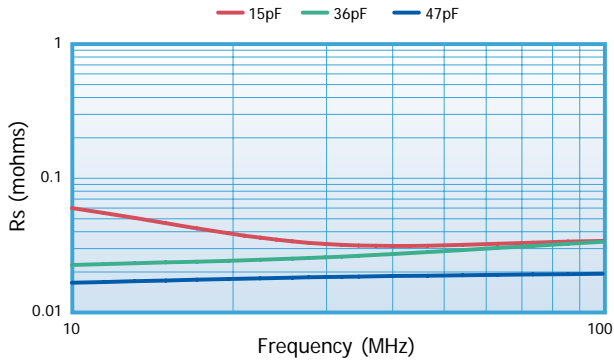

Q vs Capacitance  
DLI C40 AH Series

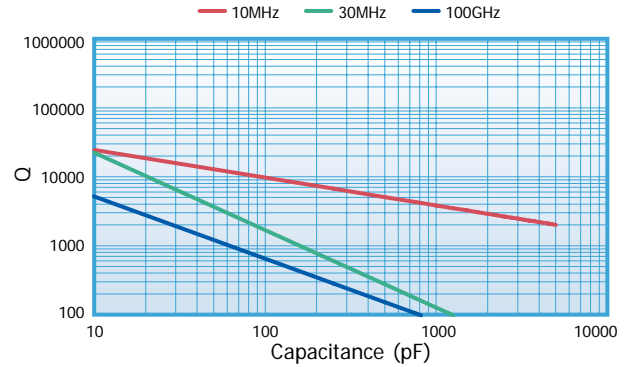

Resonant Frequency vs Capacitance  
DLI C11 AH Series

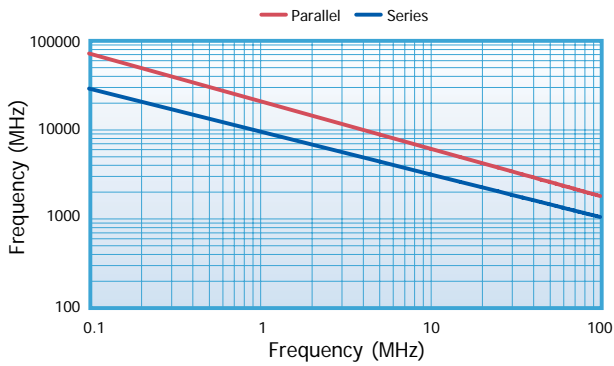

First Resonance Frequency vs Capacitance  
DLI C17 AH Series

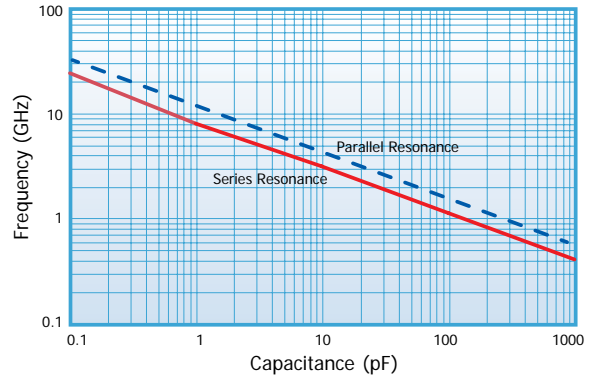

Current Rating vs Capacitance  
(infinite heat sink, 25°C ambient temperature)  
DLI C17 AH Series

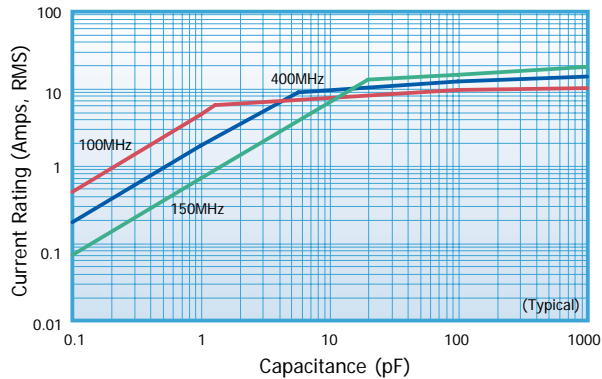

Note: This information represents typical device performance.

Ordering information - AH Series - See Page 21 for complete part number system.

C17	AH	620	J	-	7	U	A	-	X	O	T
Chip size	Dielectric	Capacitance Code (pF)	Capacitance tolerance	Voltage Code	Termination	Lead Type	Test Level	Marking	Packaging		
C11 C17 C18 C22 C40	AH = P90 High Q	1 <sup>st</sup> two digits are significant figures of capacitance, 3 <sup>rd</sup> digit denotes number of zeros, R = decimal point.  Examples: 1R0 = 1.0pF 471 = 471pF	<10pF A = ±0.05pF B = ±0.1pF C = ±0.25pF D = ±0.5pF  ≥10pF F = ±1% G = ±2% J = ±5% K = ±10% M = ±20% X = GMV S = Special	5 = 50V 1 = 100V 6 = 200V 9 = 250V 4 = 500V 7 = 1kV A = 1.5kV G = 2kV B = 2.5kV D = 3.6kV H = 7.2kV	C11/17 T, U, S, Z, E, P, Q, Y, M, W, H, V, R  C18 U, Z, E, Y, W, H  C22 U, S, Z, E, P, Q, Y, M, W, H, V, R  C40 T, U, S, Z, E, P, Q, Y, M, W, H, V, R	A = Axial ribbon B = Radial ribbon C = Center ribbon D = Special E = Axial wire F = Radial wire N = Chip  Note: C11 only available with A, B, D or N options	X = Standard Y = Reduced Visual  A = MIL-PRF-55681 Group A C = MIL-PRF-55681 Group C D = Customer Specified	C11 0, 1, 2, 5  C17 0, 1, 2, 3, 4, 5  C18 0, 1, 2, 5  C22/40 0, 1	C11/17/18 T, V, W, B, P, S  C22 T, B, P, S  C40 T, B, P, S, R		



# VC1 Residual Capacitors - X7R

The VC1 residual capacitance range MLCCs provide a more stable capacitance value with voltage - not to drop below 50% of the 1Vrms 1kHz value, up to full rated DC voltage, at room temperature.

They can be operated continuously at full rated voltage, but if derated will maintain a larger percentage of their original capacitance value, e.g. at 80% RV capacitance value equals 60% approx - see graph.

Defined capacitance value in case sizes from 0805 to 3640, with voltage rating up to 3kV. Ideal for Power supplies, capacitance critical circuits, smoothing circuits and EMI suppression.

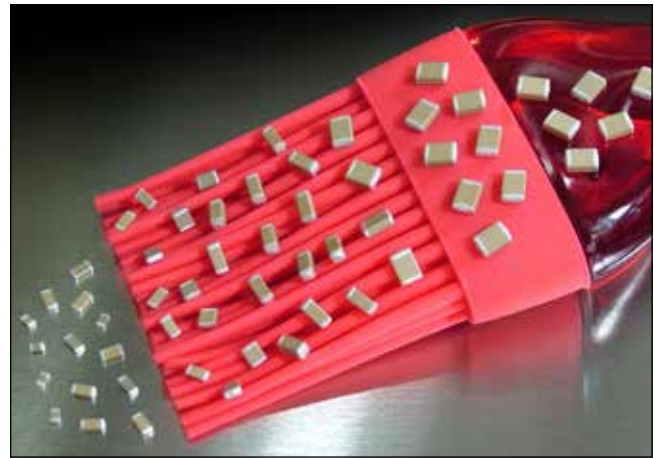

## Operating Temperature

-55°C to +125°C

## Temperature Coefficient (Typical)

± 15%

## Insulation Resistance at +25°C

Time constant (Ri xCr) (whichever is the least) 100GΩ or 1000s

## Ageing Rate

Typical 1% per time decade

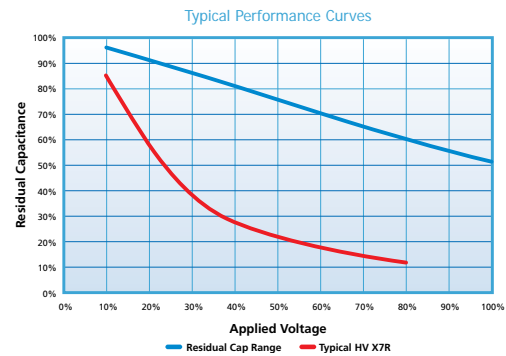

## Minimum/maximum capacitance values - VC1 Capacitors

Chip Size	0805	1206	1210	1808	1812	2220	2225	3640
Min Cap	100pF	150pF	220pF	220pF	470pF	1nF	1nF	2.2nF
250V	12nF	39nF	82nF	82nF	220nF	680nF	1µF	1.8µF
500V	2.2nF	6.8nF	15nF	15nF	56nF	150nF	220nF	560nF
630V	1.5nF	4.7nF	8.2nF	8.2nF	39nF	100nF	120nF	470nF
1000V	390pF	1.5nF	2.7nF	2.7nF	15nF	39nF	56nF	180nF
1200V	-	1nF	2.2nF	2.2nF	10nF	27nF	39nF	120nF
1500V	-	560pF	1.2nF	1.2nF	5.6nF	15nF	22nF	68nF
2000V	-	270pF	560pF	560pF	3.3nF	10nF	12nF	39nF
2500V	-	-	-	-	1.8nF	5.6nF	8.2nF	22nF
3000V	-	-	-	-	-	3.9nF	5.6nF	12nF
7" reel qty	3,000	2,500	2,000	500	500	500	500	n/a
13" reel qty	12,000	10,000	8,000	2,000	2,000	2,000	2,000	500

**Note:** Other capacitance values may become available, please contact the Sales Office if you need values other than those shown in the above table. For dimensions and soldering information, please go to our website [www.knowledscapacitors.com](http://www.knowledscapacitors.com)

## Ordering information - VC1 Capacitors

1206	Y	1K0	0152	K	X	T	VC1
Chip size	Termination	Voltage	Capacitance in picofarads (pF)	Capacitance tolerance	Dielectric	Packaging	Suffix
0805 1206 1210 1808 1812 2220 2225 3640	Y = FlexiCap™ termination base with nickel barrier (100% matte tin plating). RoHS compliant.	250 = 250V 500 = 500V 630 = 630V 1K0 = 1kV 1K2 = 1.2kV 1K5 = 1.5kV 2K0 = 2.0kV 2K5 = 2.5kV 3K0 = 3.0kV	First digit is 0. Second and third digits are significant figures of capacitance code. The fourth digit is number of 0's following Example: 0152 = 1500pF	J = ±5% K = ±10% M = ±20%	X = X7R	T = 178mm (7") reel R = 330mm (13") reel B = Bulk pack - tubs	

# TCC/VCC Capacitors - (BX & BZ) X7R

X7R capacitors with a defined capacitance variation under applied dc voltage, across the full operating temperature range.

Whilst the capacitance of COG/NP0 chips does not vary with applied voltage, standard X7R capacitors exhibit capacitance fluctuation but with no specified limit.

For applications where a limit is required, Knowles is able to offer either a "B" code dielectric (conforms to MIL "BX" dielectric and IECQ-CECC "2X1") or "R" code dielectric (conforms to MIL "BZ" dielectric and IECQ-CECC "2C1").

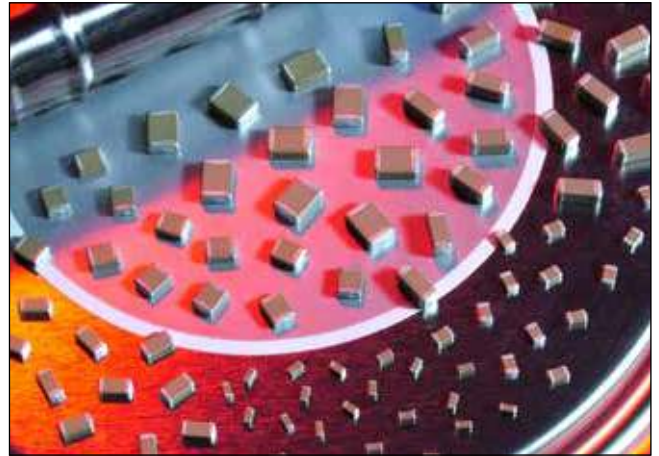

## TCC/VCC Capacitors - 2X1 (BX)

Capacitance	Code	0603	0805	1206	1210	1808	1812	2220	2225	Capacitance	Code
100pF	101									100pF	101
120	121									120	121
150	151									150	151
180	181									180	181
220	221									220	221
270	271									270	271
330	331									330	331
390	391									390	391
470	471									470	471
560	561									560	561
680	681									680	681
820	821									820	821
1.0nF	102									1.0nF	102
1.2	122									1.2	122
1.5	152									1.5	152
1.8	182									1.8	182
2.2	222									2.2	222
2.7	272									2.7	272
3.3	332									3.3	332
3.9	392									3.9	392
4.7	472									4.7	472
5.6	562									5.6	562
6.8	682									6.8	682
8.2	822									8.2	822
10	103									10	103
12	123									12	123
15	153									15	153
18	183									18	183
22	223									22	223
27	273									27	273
33	333									33	333
39	393									39	393
47	473									47	473
56	563									56	563
68	683									68	683
82	823									82	823
100	104									100	104
120	124									120	124
150	154									150	154
180	184									180	184
220	224									220	224
270	274									270	274
330	334									330	334
390	394									390	394
470	474									470	474
560	564									560	564
680	684									680	684
820	824									820	824
1.0µF	105									1.0µF	105
1.2µF	125									1.2µF	125
1.5µF	155									1.5µF	155

● = non RoHS compliant and FlexiCap™ termination only. Other values available in J, Y (FlexiCap™) and F terminations.

# TCC/VCC Capacitors - (BX & BZ) X7R

## TCC/VCC Capacitors - 2C1 (BZ)

Capacitance	Code	0603	0805	1206	1210	1808	1812	2220	2225	Capacitance	Code
100pF	101									100pF	101
120	121									120	121
150	151									150	151
180	181									180	181
220	221									220	221
270	271									270	271
330	331									330	331
390	391									390	391
470	471									470	471
560	561									560	561
680	681									680	681
820	821									820	821
1.0nF	102									1.0nF	102
1.2	122									1.2	122
1.5	152									1.5	152
1.8	182									1.8	182
2.2	222									2.2	222
2.7	272									2.7	272
3.3	332									3.3	332
3.9	392									3.9	392
4.7	472									4.7	472
5.6	562									5.6	562
6.8	682									6.8	682
8.2	822									8.2	822
10	103									10	103
12	123									12	123
15	153									15	153
18	183									18	183
22	223									22	223
27	273									27	273
33	333									33	333
39	393									39	393
47	473									47	473
56	563									56	563
68	683									68	683
82	823									82	823
100	104									100	104
120	124									120	124
150	154									150	154
180	184									180	184
220	224									220	224
270	274									270	274
330	334									330	334
390	394									390	394
470	474									470	474
560	564									560	564
680	684									680	684
820	824									820	824
1.0µF	105									1.0µF	105
1.2µF	125									1.2µF	125
1.5µF	155									1.5µF	155

● = non RoHS compliant and FlexiCap™ termination only. Other values available in J, Y (FlexiCap™) and F terminations.

## Ordering information - TCC/VCC Capacitors

0603	J	050	0471	J	B	B	---
Chip size	Termination	Voltage	Capacitance in picofarads (pF)	Capacitance tolerance	Dielectric	Packing	Suffix code
0603 0805 1206 1210 1808 1812 2220 2225	<p><b>Y</b> = FlexiCap™ termination base with Ni barrier (100% matte tin plating). RoHS compliant.</p> <p><b>H</b> = FlexiCap™ termination base with Ni barrier (Tin/lead plating with min. 10% lead). Not RoHS compliant.</p> <p><b>F</b> = Silver Palladium. RoHS compliant.</p> <p><b>J</b> = Nickel barrier (100% matte tin plating). RoHS compliant. Lead free.</p> <p><b>A</b> = Nickel barrier (Tin/lead plating with min. 10% lead). Not RoHS compliant.</p>	<p><b>050</b> = 50V</p> <p><b>100</b> = 100V</p> <p><b>200</b> = 200V</p>	<p>1st digit is 0.</p> <p>2nd and 3rd digits are significant figures of capacitance code.</p> <p>The 4th digit is number of 0's following eg. <b>0471</b> = 470pF</p> <p><b>0824</b> = 820nF</p>	<p><b>G</b> = ±2%</p> <p><b>J</b> = ±5%</p> <p><b>K</b> = ±10%</p> <p><b>M</b> = ±20%</p>	<p><b>B</b> = 2X1/BX released in accordance with IECQ-CECC</p> <p><b>R</b> = 2C1/BZ released in accordance with IECQ-CECC</p>	<p><b>T</b> = 178mm (7") reel</p> <p><b>R</b> = 330mm (13") reel</p> <p><b>B</b> = Bulk pack - tubs</p>	Used for specific customer requirements

# Open Mode and Tandem Capacitors - X7R

Open Mode capacitors have been designed specifically for use in applications where mechanical cracking is a severe problem and short circuits due to cracking are unacceptable.

Open Mode capacitors use inset electrode margins, which prevent any mechanical cracks which may form during board assembly from connecting to the internal electrodes.

When combined with FlexiCap™ termination, Open Mode capacitors provide a robust component with the assurance that if a part becomes cracked, the crack will be unlikely to result in short circuit failure.

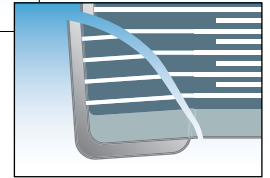
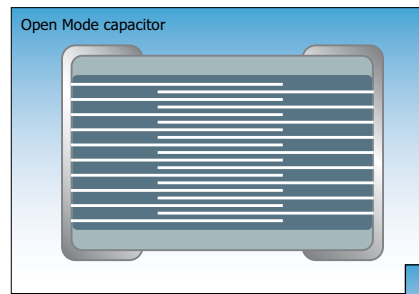

Qualification included cracking the components by severe bend tests. Following the bend tests cracked components were subjected to endurance / humidity tests, with no failures evident due to short circuits.  
Note: Depending on the severity of the crack, capacitance loss was between 0% and 70%.

## Open Mode max capacitance (X7R only) ■ = AEC-Q200 qualified

	0603	0805	1206	1210	1808	1812	2220	2225
16V	39nF	100nF 150nF	220nF 470nF	470nF 680nF	680nF	1.5µF	3.3µF	4.7µF
25V	33nF	100nF 120nF	220nF 330nF	470nF 560nF	560nF	1.2µF	2.2µF	3.9µF
50/63V	22nF	100nF	220nF	470nF	470nF	1.0µF	1.5µF	2.7µF
100V	6.8nF	27nF	100nF	220nF	220nF	680nF	1.0µF	1.5µF 1.8µF
200/250V	2.7nF	22nF	68nF	100nF	100nF	330nF	680nF	1.0µF
500V	-	5.6nF	39nF	68nF	68nF	180nF	330nF	390nF
630V	-	-	22nF	33nF	27nF	100nF	180nF	220nF
1kV	-	-	6.8nF	15nF	15nF	47nF	82nF 100nF	100nF

Tandem Capacitors have been designed as a fail safe range using a series section internal design, for use in any application where short circuits would be unacceptable.

When combined with FlexiCap™ termination, Tandem capacitors provide an ultra robust and reliable component, for use in the most demanding applications.

Non-standard voltages are available. For more information please consult the Sales Office.

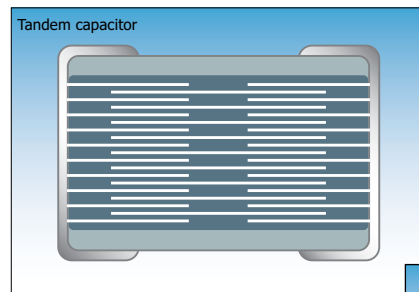

Qualification included cracking the components by severe bend tests. Following the bend tests cracked components were subjected to endurance / humidity tests, with no failures evident due to short circuits.  
Note: Depending on the severity of the crack, capacitance loss was between 0% and 50%.

## Tandem max capacitance (X7R only) ■ = AEC-Q200 qualified

	0603	0805	1206	1210	1812	2220	2225
16V	12nF	47nF	150nF	270nF	560nF	1.2µF	1.5µF
25V	10nF	39nF	120nF	220nF	470nF	1.0µF	1.2µF
50/63V	6.8nF	33nF	100nF	180nF	390nF	680nF	1.0µF
100V	2.2nF	10nF	47nF	82nF	220nF	470nF	680nF
200/250V	1.0nF	4.7nF	22nF	47nF	100nF	220nF	330nF

## Ordering information - Open Mode and Tandem Capacitors

1206	Y	050	0224	K	X	T	---
Chip size	Termination	Voltage	Capacitance in picofarads (pF)	Capacitance tolerance	Dielectric codes	Packaging	Suffix code
0603 0805 1206 1210 1808 1812 2220 2225	Y = FlexiCap™ termination base with nickel barrier (100% matte tin plating). RoHS compliant.	016 = 16V 025 = 25V 050 = 50V 063 = 63V 100 = 100V 200 = 200V 250 = 250V 500 = 500V 630 = 630V 1K0 = 1kV	First digit is 0. Second and third digits are significant figures of capacitance code. The fourth digit is number of zeros following. Example: 0224 = 220000pF	J = ±5% K = ±10% M = ±20%	X = X7R S = X7R BME (AEC-Q200) E = X7R (AEC-Q200 product)	T = 178mm (7") reel R = 330mm (13") reel B = Bulk pack - tubs or trays	M01 = Open Mode capacitor T01 = Tandem capacitor

# IECQ-CECC range - Specialty High Rel. and approved parts

A range of specialist, high reliability, multilayer ceramic capacitors for use in critical or high reliability environments. All fully tested / approved and available with a range of suitable termination options, including tin/lead plating and Knowles FlexiCap™.

Ranges include:

1. Range tested and approved in accordance with IECQ-CECC QC32100.
2. Range qualified to the requirements of Knowles detail specification S02A-0100 (based on ESCC 3009).

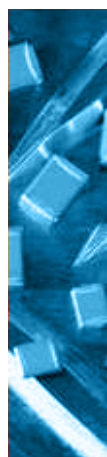

## IECQ-CECC - maximum capacitance values

		0603	0805	1206	1210	1808	1812	2220	2225
16V	COG/NPO	1.5nF	6.8nF	22nF	33nF	33nF	100nF	150nF	220nF
	X7R	100nF	330nF	1.0µF	1.5µF	1.5µF	3.3µF	5.6µF	6.8µF
25V	COG/NPO	1.0nF	4.7nF	15nF	22nF	27nF	68nF	100nF	150nF
	X7R	56nF	220nF	820nF	1.2µF	1.2µF	2.2µF	4.7µF	5.6µF
50/63V	COG/NPO	470pF	2.7nF	10nF	18nF	18nF	33nF	68nF	100nF
	X7R	47nF	220nF	470nF	1.0µF	680nF	1.5µF	2.2µF	3.3µF
100V	COG/NPO	330pF	1.8nF	6.8nF	12nF	12nF	27nF	47nF	68nF
	X7R	10nF	47nF	150nF	470nF	330nF	1.0µF	1.5µF	1.5µF
200/ 250V	COG/NPO	100pF	680pF	2.2nF	4.7nF	4.7nF	12nF	22nF	27nF
	X7R	5.6nF	27nF	100nF	220nF	180nF	470nF	1.0µF	1.0µF
500V	COG/NPO	n/a	330pF	1.5nF	3.3nF	3.3nF	10nF	15nF	22nF
	X7R	n/a	8.2nF	33nF	100nF	100nF	270nF	560nF	820nF
1kV	COG/NPO	n/a	n/a	470pF	1.0nF	1.2nF	3.3nF	8.2nF	10nF
	X7R	n/a	n/a	4.7nF	15nF	18nF	56nF	120nF	150nF

## Ordering information - IECQ-CECC range

1210	Y	100	0103	J	D	T	---
Chip size	Termination	Voltage	Capacitance in picofarads (pF)	Capacitance tolerance	Dielectric Release codes	Packaging	Suffix code
0603 0805 1206 1210 1808 1812 2220 2225	<p><b>Y</b> = FlexiCap™ termination base with Ni barrier (100% matte tin plating). RoHS compliant.</p> <p><b>H</b> = FlexiCap™ termination base with Ni barrier (Tin/lead plating with min. 10% lead). Not RoHS compliant.</p> <p><b>F</b> = Silver Palladium. RoHS compliant.</p> <p><b>J</b> = Nickel barrier (100% matte tin plating). RoHS compliant. Lead free.</p> <p><b>A</b> = Nickel barrier (Tin/lead plating with min. 10% lead). Not RoHS compliant.</p>	<p><b>016</b> = 16V <b>025</b> = 25V <b>050</b> = 50V <b>063</b> = 63V <b>100</b> = 100V <b>200</b> = 200V <b>250</b> = 250V <b>500</b> = 500V <b>630</b> = 630V <b>1K0</b> = 1kV</p>	<p>First digit is 0.</p> <p>Second and third digits are significant figures of capacitance code.</p> <p>The fourth digit is number of zeros following</p> <p>Example: <b>0103</b> = 10nF</p>	<p>&lt;10pF <b>B</b> = ±0.1pF <b>C</b> = ±0.25pF <b>D</b> = ±0.5pF</p> <p>≥10pF <b>F</b> = ±1% <b>G</b> = ±2% <b>J</b> = ±5% <b>K</b> = ±10% <b>M</b> = ±20%</p>	<p><b>D</b> = X7R (2R1) with IECQ-CECC release</p> <p><b>F</b> = COG/NPO (1B/NPO) with IECQ-CECC release</p> <p><b>B</b> = 2X1/BX released in accordance with IECQ-CECC</p> <p><b>R</b> = 2C1/BZ released in accordance with IECQ-CECC</p> <p>For <b>B</b> and <b>R</b> codes please refer to TCC/VCC range for full capacitance values</p>	<p><b>T</b> = 178mm (7") reel <b>R</b> = 330mm (13") reel <b>B</b> = Bulk pack - tubs or trays</p>	Used for specific customer requirements

# Automotive Grade Capacitors - AEC-Q200 range

We offer a range of high quality automotive grade components. With AEC-Q200 approved ranges up to a voltage rating of 3kV we provide for the requirements of modern automotive applications including EV and HEV.

Ranges include :-

1. Standard MLCCs
2. StackiCap™ - large capacitance/small case size MLCCs
3. Open Mode and Tandem capacitors
4. 3 terminal EMI components
5. X2Y Integrated Passive Component
6. X8R high temperature MLCCs
7. Safety Certified MLCCs

All fully tested / approved and available with a range of suitable termination options, including tin/lead plating and Knowles FlexiCap™.



## AEC-Q200 MLCC range - maximum capacitance values

		0603	0805	1206	1210	1808	1812	1825	2220	2225	3640			
							StackiCap™ 3.2mm max thickness		StackiCap™ 4.2mm max thickness		StackiCap™ 4.2mm max thickness			
50/ 63V	COG/NPO	1nF	4.7nF	15nF	27nF	27nF	47nF	-	82nF	100nF	-	150nF	220nF	-
	X7R	100nF *	220nF	470nF	1µF	-	2.2µF	-	2.2µF	3.3µF	-	3.3µF	4.7µF	-
100V	COG/NPO	470pF	2.2nF	8.2nF	15nF	15nF	39nF	-	47nF	56nF	-	68nF	180nF	-
	X7R	47nF	100nF	220nF	680nF	-	1µF	-	1.5µF	1.5µF	-	2.2µF	3.3µF	-
	X8R	-	33nF	100nF	220nF	220nF	470nF	-	-	1.0µF	-	1.5µF	-	-
200/ 250V	COG/NPO	220pF	1nF	3.9nF	8.2nF	8.2nF	18nF	-	27nF	33nF	-	33nF	82nF	-
	X7R	10nF	47nF	150nF	330nF	-	680nF	1.0µF	1.0µF	1.0µF	-	1.5µF	1.5µF	-
	X8R	-	15nF	68nF	150nF	150nF	330nF	-	-	680nF	-	1.0µF	-	-
500V	COG/NPO	-	680pF	2.7nF	6.8nF	5.6nF	15nF	-	18nF	22nF	-	22nF	56nF	-
	X7R	-	15nF	68nF	150nF	-	330nF	470nF	560nF	560nF	-	680nF	1.0µF	-
	X8R	-	4.7nF	22nF	47nF	47nF	120nF	-	-	330nF	-	470nF	-	-
630V	COG/NPO	-	560pF	2.7nF	6.8nF †	3.9nF	15nF	-	10nF	15nF	-	15nF	39nF	-
	X7R	-	10nF	47nF	100nF	-	150nF	330nF	200nF	330nF	1.0µF	390nF	680nF	-
	X8R	-	2.2nF	10nF	33nF	33nF	68nF	-	-	180nF	-	220nF	-	-
1kV	COG/NPO	-	150pF	1.5nF	2.2nF	2.2nF	5.6nF	-	10nF	10nF	-	10nF	22nF	-
	X7R	-	4.7 nF	10nF	47nF	-	68nF	180nF	200nF	120nF	470nF	150nF	180nF	1.0µF
	X8R	-	1.5nF	3.3nF	6.8nF	6.8nF	27nF	-	-	68nF	-	82nF	-	-
1.2kV	COG/NPO	-	68pF	390pF	680pF	1.0nF	3.3nF	-	4.7nF	4.7nF	-	6.8nF	18nF	-
	X7R	-	-	3.3nF	18nF	-	33nF	100nF	68nF	82nF	-	100nF	150nF	-
	X8R	-	-	2.2nF	5.6nF	5.6nF	15nF	-	-	47nF	-	56nF	-	-
1.5kV	COG/NPO	-	68pF	390pF	680pF	680pF	2.2nF	-	3.9nF	4.7nF	-	4.7nF	12nF	-
	X7R	-	-	2.7nF	6.8nF	-	22nF	-	47nF	47nF	-	68nF	100nF	-
	X8R	-	-	1.5nF	3.3nF	3.3nF	10nF	-	-	27nF	-	33nF	-	-
2kV	COG/NPO	-	47pF	220pF	470pF	470pF	1.5nF	-	1.8nF	2.2nF	-	2.2nF	5.6nF	-
	X7R	-	-	2.2nF	4.7nF	-	10nF	-	10nF	27nF	-	33nF	47nF	-
	X8R	-	-	680pF	1.5nF	1.5nF	5.6nF	-	-	15nF	-	22nF	-	-
2.5kV	COG/NPO	-	-	100pF	180pF	270pF	680pF	-	-	1.5nF	-	-	-	-
	X8R	-	-	-	-	1.2nF	3.3nF	-	-	10nF	-	12nF	-	-
3kV	COG/NPO	-	-	68pF	150pF	220pF	470pF	-	-	1nF	-	-	-	-
	X8R	-	-	-	-	820pF	2.7nF	-	-	5.6nF	-	6.8nF	-	-

Notes: 1) \* 0603 Max thickness 0.9mm above 56nF, FB6 suffix code. 2) † 1210 Max thickness 2.2mm as suffix AG1. 3) See page 62 for full details of the StackiCap™ range.

## Safety Certified Capacitors

Dielectric	Approval Body	X1 PY2		X2 SP	Y2/X1 SP		Y2/X1 B16	X2 B17
		1808	1812	1808	2211	2215	2220	2220
COG/NPO	TÜV, UL	4.7pF - 390pF	4.7pF - 390pF	4.7pF - 1.5nF	4.7pF - 1.0nF	820pF - 1.0nF	-	-
X7R	TÜV, UL	150pF - 1nF	150pF - 2.2nF	150pF - 4.7nF	100pF - 3.9nF	2.7nF - 3.9nF	150pF - 10nF	150pF - 22nF (TÜV approval only)

Note: See pages 66 and 67 for full details of 250Vac Safety Certified AC Capacitors and ordering information.

# Automotive Grade Capacitors - AEC-Q200 range

## AEC-Q200 range - Open Mode - max capacitance values

	0603	0805	1206	1210	1808	1812	2220	2225
	X7R	X7R	X7R	X7R	X7R	X7R	X7R	X7R
50/63V	22nF	100nF	220nF	470nF	470nF	1.0µF	1.5µF	2.7µF
100V	6.8nF	27nF	100nF	220nF	220nF	680nF	1.0µF	1.5µF
200/250V	2.7nF	15nF	68nF	100nF	100nF	330nF	680nF	1.0µF
500V	-	5.6nF	39nF	68nF	68nF	180nF	330nF	390nF
630V	-	-	22nF	33nF	27nF	100nF	180nF	220nF
1kV	-	-	6.8nF	15nF	15nF	47nF	82nF	100nF

See page 56 for full details of the product range.

## AEC-Q200 range - Tandem - max capacitance values

	0603	0805	1206	1210	1812
	X7R	X7R	X7R	X7R	X7R
50/63V	6.8nF	33nF	100nF	180nF	390nF
100V	2.2nF	10nF	47nF	82nF	220nF
200/250V	1.0nF	4.7nF	22nF	47nF	100nF

See page 56 for full details of the product range.

## AEC-Q200 range - 3 Terminal EMI Components (E01 & E07) - max capacitance values

		E01			E07		
		0805	1206	1806	0805	1206	1806
50V	COG/NPO	820pF	1.0nF	2.2nF	220pF	1nF	1.5nF
	X7R	47nF	100nF	200nF	47nF	100nF	200nF
100V	COG/NPO	560pF	1.0nF	2.2nF	120pF	560pF	680pF
	X7R	15nF	15nF	68nF	15nF	15nF	68nF

Note: For some lower capacitance parts, higher voltage rated parts may be supplied. See page 92 for full details of the product range.

## AEC-Q200 range - X2Y Integrated Passive Components (E03) - capacitance values

		0805	1206	1410	1812
		50V	COG/NPO	390pF - 470pF	1.2nF - 1.5nF
	X7R	18nF - 33nF	56nF - 150nF	180nF - 330nF	390nF - 560nF
100V	COG/NPO	10pF - 330pF	22pF - 1.0nF	100pF - 3.9nF	820pF - 6.8nF
	X7R	470pF - 15nF	1.5nF - 47nF	4.7nF - 150nF	8.2nF - 330nF

Note: For some lower capacitance parts, higher voltage rated parts may be supplied. See page 94 for full details of the product range.

## Ordering information - AEC-Q200 ranges

1210	Y	100	0103	K	S	T	---
Chip size	Termination	Voltage	Capacitance in picofarads (pF)	Capacitance tolerance	Dielectric Release codes	Packaging	Suffix code
0603 0805 1206 1210 1808 1812 1825 2220 2225 3640	<p>Y = FlexiCap™ termination base with Ni barrier (100% matte tin plating). RoHS compliant.</p> <p>H = FlexiCap™ termination base with Ni barrier (Tin/lead plating with min. 10% lead). Not RoHS compliant.</p> <p>J = Nickel barrier (100% matte tin plating). RoHS compliant. Lead free.</p> <p>A = Nickel barrier (Tin/lead plating with min. 10% lead). Not RoHS compliant.</p> <p>Note: AEC-Q200 X7R is only available in Y or H termination.</p>	<p>050 = 50V</p> <p>063 = 63V</p> <p>100 = 100V</p> <p>200 = 200V</p> <p>250 = 250V</p> <p>500 = 500V</p> <p>630 = 630V</p> <p>1K0 = 1kV</p> <p>1K2 = 1.2kV</p> <p>1K5 = 1.5kV</p> <p>2K0 = 2kV</p> <p>2K5 = 2.5kV</p> <p>3K0 = 3kV</p>	<p>First digit is 0.</p> <p>Second and third digits are significant figures of capacitance code.</p> <p>The fourth digit is number of zeros following</p> <p>Example: 0103 = 10nF</p>	<p>F = ±1%</p> <p>G = ±2%</p> <p>J = ±5%</p> <p>K = ±10%</p> <p>M = ±20%</p>	<p>S = X7R (BME) AEC-Q200</p> <p>E = X7R (2R1) AEC-Q200</p> <p>A = COG/NPO (1B/NPO) AEC-Q200</p> <p>T = X8R with AEC-Q200 release</p>	<p>T = 178mm (7") reel</p> <p>R = 330mm (13") reel</p> <p>B = Bulk pack - tubs or trays</p>	<p>WS2 = StackiCap™</p> <p>M01 = Open Mode</p> <p>T01 = Tandem</p> <p>E01 &amp; E07 = 3 terminal EMI component</p> <p>E03 = X2Y product</p>

# High Capacitance Chip - X7R, X5R

A range of High Capacitance value BME MLC chip capacitors, in stable Class II dielectrics X7R and X5R, with a spread of capacitance values offered up to 100µF.

Comparable circuit designs can be achieved at typically a third to a fifth of the capacitance values because of the low ESR characteristics these parts exhibit. As a consequence they are also ideal to replace Tantalum and Low ESR Electrolytic Capacitors without polarity concerns. They find application as power supply bypass capacitors, smoothing capacitors, input/output filters in DC-DC Converters and in digital circuits and LCD modules.

Parts are RoHS Compliant and suitable for reflow soldering process.

- Nickel Barrier terminations with tin, tin/lead or gold flash
- Capacitance tolerances available: ±10%, ±20%
- Available with high reliability screening. Contact the Knowles Capacitors Sales Office for details



## Capacitance values - High Capacitance Chip

Size	0402		0603		0805		1206		1210				1812	
Tmax <small>inches: mm:</small>	0.024 0.61		0.035 0.89		0.054 1.37		0.072* 1.83		0.085* 2.16		0.110* 2.79		0.110* 2.79	
Dielectric	X7R	X5R	X7R	X5R	X7R	X5R	X7R	X5R	X7R	X5R	X7R	X5R	X7R	X5R
4V				22µF†				100µF†						-
6.3V	470nF	1µF 2.2µF† 4.7µF†		4.7µF 10µF†		22µF†		47µF†		47µF†	47µF†	100µF†		-
10V		1µF	2.2µF	4.7µF 10µF†	10µF†	10µF	22µF†	22µF†		22µF†		47µF†		-
16V	15nF 22nF 33nF 47nF 100nF 220nF	220nF 470nF 100nF 220nF 470nF	100nF 1µF	2.2µF 4.7µF	470nF 1.0µF 2.2µF 4.7µF†	4.7µF 10µF	10µF	10µF 22µF†	4.7µF† 10µF†			22µF†		-
25V	6.8nF 10nF 47nF 100nF	10nF 220nF	470nF 1.0µF	220nF 470nF 1.0µF 2.2µF	1.0µF 2.2µF 4.7µF	2.2µF 4.7µF	2.2µF 4.7µF 10µF	4.7µF 10µF	3.3µF† 4.7µF†	4.7µF† 10µF†	22µF†			-
35V										2.2µF† 4.7µF†		10µF		-
50V	10nF	100nF	220nF 470nF	100nF 470nF 1.0µF	220nF 470nF 1.0µF	220nF 470nF 1.0µF 2.2µF	470nF 1.0µF 2.2µF 4.7µF	4.7µF	1.0µF			4.7µF†	4.7µF† 10µF†	-
100V			100nF		220nF		1.0µF		1.0µF 2.2µF				1.0µF 2.2µF	-

\* Denotes non standard chip thickness. Order code needs to have an 'X' inserted together with the dimension in inches -e.g. X072 where dimension is 0.072".

† Denotes only available in ±20% capacitance tolerance



# High Capacitance Chip - X7R, X5R

## Comparison with other dielectric capacitors

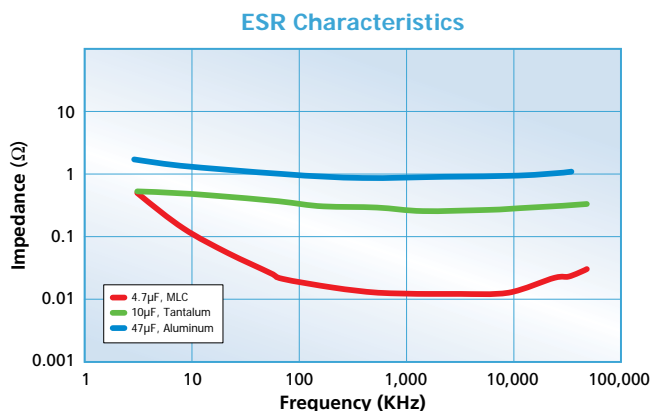
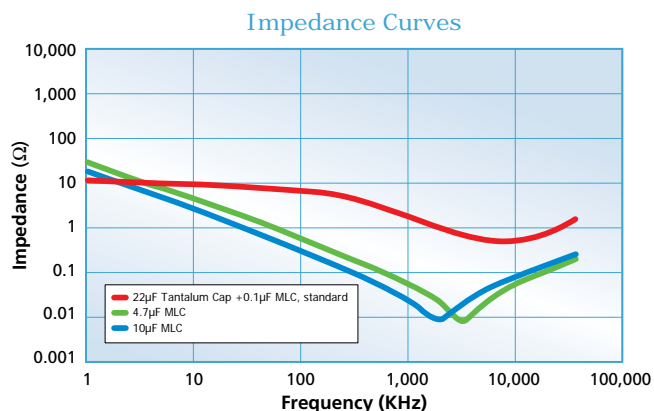

## Dielectric characteristics

	X7R (BB) Stable	X5R (BW) Stable
Operating temperature range:	-55°C to 125°C	-55°C to 85°C
Temperature coefficient:	±15% ΔC Max.	±15% ΔC Max.
Dissipation factor:	3.5% max except: 0402 ≥ 0.1µF = 5%, 0603 ≥ 0.22µF = 10%, 0805 ≥ 1.0µF = 5%, 0805 ≥ 2.2µF = 10%, 1206 ≥ 2.2µF = 10%, 1210 ≥ 4.7µF = 5%, 1210 ≥ 22µF = 10%	5% max except: 0402 ≥ 1.0µF = 10%, 0603 ≥ 1.0µF = 10%, 0805 ≥ 4.7µF = 10%, 1206 ≥ 4.7µF = 10%, 1210 ≥ 10µF = 10%
Insulation resistance @25°C:	>10GΩ or >100ΩF whichever is less	>10GΩ or >100ΩF whichever is less
Dielectric withstanding voltage:	250%	250%
Ageing Rate:	X7R 3.5% typical	X5R 5% typical
Test parameters @ 25°C:	1KHz, 1.0 ±0.2 VRMS	1KHz, 1.0 ±0.2 VRMS 120Hz, 0.5 ±0.1 VRMS for 22µF, 47µF & 100µF

## Ordering information - High Capacitance Chip Capacitors

1206	W	476	K	6R3	N	X080	T
Chip sizes	Dielectric	Capacitance	Tolerance	Voltage-VDCW	Termination	Thickness option	Packing
0402 0603 0805 1206 1210 1812	BB* = X7R BW* = X5R  *Formerly B & W codes	Value in Picofarads. Two significant figures, followed by number of zeros: 476 = 47µF (47,000,000pF)	K = ± 10% M = ± 20%	Two significant figures, followed by number of zeros. R denotes decimal point: 6R3 = 6.3V 501 = 500V	N = Nickel Barrier (100% tin) Y = Nickel Barrier (90% tin/10% lead) NG = Nickel Barrier Gold Flash	Blank = Standard thickness X = special thickness, specified in inches: X085 = 0.085"	No suffix = Bulk T = Tape & Reel

Note: BME parts available with added high reliability test. Consult the factory.

# StackiCap™ Capacitors - X7R



The StackiCap™ range offers a significant reduction in 'PCB real estate' for an equivalent capacitance value when board space is at a premium. For example, a standard 150nF chip in a 8060 case size is now available in a much smaller 3640 case size.

Knowles's unique patented\* construction and FlexiCap™ termination material make the StackiCap™ range suitable for applications including: power supplies, lighting, aerospace electronics and high voltage applications where a large amount of capacitance is required. Further developments are on-going, please contact the Sales Office for details of the full range.

\* StackiCap™ technology is protected by international patents (pending) EP2847776, WO2013186172A1, US20150146343A1 and CN104471660A.

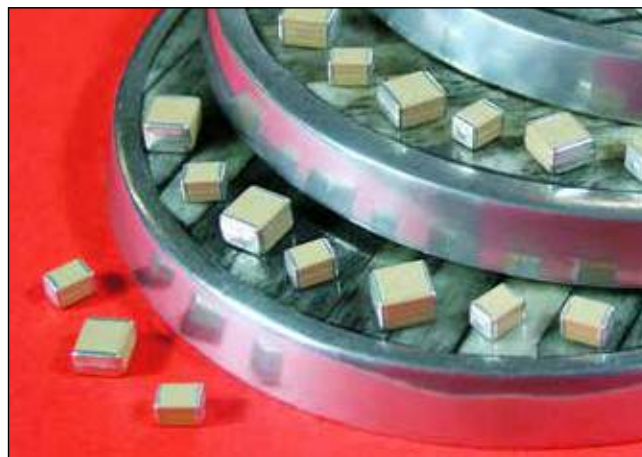

## Maximum capacitance

Up to 5.6µF

## Maximum voltage

Up to 2kV

## Insulation resistance

Time Constant (RxCr) (whichever is the least - 500s or 500MΩ)

## Maximum capacitance values - StackiCap™ Capacitors

Chip size	1812	2220	3640
Thickness max.	3.2mm	4.2mm	4.2mm
200/250V	1.0µF	2.2µF	5.6µF
500V	470nF	1.2µF	2.7µF
630V	330nF	1.0µF	2.2µF
1kV	180nF	470nF	1.0µF
1.2kV	100nF	220nF	470nF
1.5kV	56nF	150nF	330nF
2kV	33nF	100nF	150nF

■ = AEC-Q200

## Ordering information - StackiCap™ Capacitors

1812	Y	500	0474	K	J	T	WS2
Chip size	Termination	Voltage	Capacitance in picofarads (pF)	Capacitance tolerance	Dielectric	Packaging	Suffix code
1812 2220 3640	Y = FlexiCap™ termination base with nickel barrier (100% matte tin plating). RoHS compliant. Lead free. H = FlexiCap™ Termination base with nickel barrier (Tin/lead plating with minimum 10% lead). Not RoHS compliant.	200/250 = 200/250V 500 = 500V 630 = 630V 1K0 = 1kV 1K2 = 1.2kV 1K5 = 1.5kV 2K0 = 2kV	First digit is 0. Second and third digits are significant figures of capacitance code in picofarads (pF). Fourth digit is number of zeros eg. 0474 = 470nF Values are E12 series	J = ±5% K = ±10% M = ±20%	J = X7R (BME) E = X7R (2R1) AEC-Q200 S = X7R (BME) AEC-Q200 X = X7R	T = 178mm (7") reel R = 330mm (13") reel B = Bulk pack - tubs or trays	WS2

## Reeled quantities - StackiCap™ Capacitors

	1812	2220	3640
178mm (7") Reel	500	500	-
330mm (13") Reel	2,000	2,000	500



Note: Parts in this range may be defined as dual-use under export control legislation as such may be subject to export licence restrictions.

Please refer to page 12 for more information on the dual-use regulations and contact the Sales Office for further information on specific part numbers.

# NC Capacitors - X7R

MLCCs are particularly suitable for high voltage applications where small size is required. For standard high voltage capacitors a coating may be required to be applied post soldering.

The NC range is designed to achieve the maximum capacitance range possible for a given component size and high voltage, but 100% coating of the chip after mounting, including especially between the board and the component (between the mounting pads) is mandatory to ensure flashover does not occur. To ensure the coating achieves total coverage around all four exposed sides of the chip, it may be necessary to slot or cut the PCB under the chip. Knowles / Syfer application note AN0043 gives more information on the coating requirements.

This range is fully compliant with the RoHS, REACH and WEEE directives.

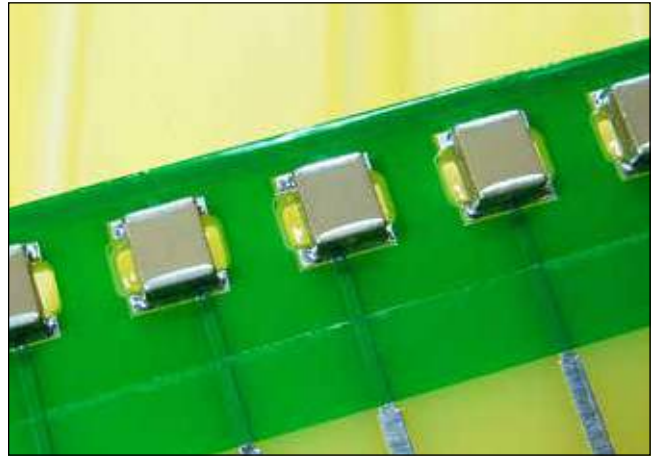

## Operating Temperature

-55°C to +125°C

## Temperature Coefficient (Typical)

± 15%

## Insulation Resistance at +25°C

Time constant ( $R_i \times C_r$ ) (whichever is the least) 100GΩ or 1000s

## Ageing Rate

Typical <2% per time decade

## Minimum/maximum capacitance values - NC Capacitors

Chip size	1206	1210	1808	1812	2220
Min Cap	220pF	680pF	330pF	470pF	1.0nF
2kV	3.3nF	5.6nF	5.6nF	12nF	-
2.5kV	2.7nF	4.7nF	4.7nF	8.2nF	22nF
3kV	1.5nF	3.3nF	3.3nF	4.7nF	10nF
4kV	-	-	2.2nF	3.3nF	6.8nF
5kV	-	-	-	-	4.7nF
7" reel qty	2,500	2,000	500	500	500
13" reel qty	10,000	8,000	2,000	2,000	2,000

Note: Other capacitance values may become available, please contact the Sales Office if you need values other than those shown in the above table. For dimensions and soldering information, please go to our website [www.knowlescapacitors.com](http://www.knowlescapacitors.com).

## Ordering information - NC Capacitors

1206	J	3K0	0102	K	X	T	NC
Chip size	Termination	Voltage	Capacitance in picofarads (pF)	Capacitance tolerance	Dielectric	Packaging	Suffix
1206 1210 1808 1812 2220	Y = FlexiCap™ termination base with nickel barrier (100% matte tin plating). RoHS compliant. Lead free.  J = Nickel barrier (100% matte tin plating). RoHS compliant. Lead free.	2K0 = 2kV 2K5 = 2.5kV 3K0 = 3kV 4K0 = 4kV 5K0 = 5kV	First digit is 0. Second and third digits are significant figures of capacitance code. Fourth digit is number of zeros eg. 0102 = 1000pF Values are E24 series	J = ±5% K = ±10% M = ±20%	X = X7R	T = 178mm (7") reel R = 330mm (13") reel B = Bulk pack - tubs or trays	NC Range

# 250Vac Rated 50/60Hz AC Capacitors - COG/NP0 & X7R

Industry wide standard multilayer ceramic capacitors are supplied with a DC rating only. For AC use, Surge and Safety capacitors with an AC rating of 250Vac have been available but the capacitance range is limited as a result of the strict impulse and VP requirements in the international standards. Knowles Technology have developed a range which provides a solution for use at up to 250Vac 60Hz continuous use and provides for non safety-critical applications where extended capacitance ranges are required.

## Capacitance range

Case sizes 0805 to 2220 are available in both X7R and COG/NP0 dielectrics with capacitances of up to 120nF. The capacitance ranges are divided into four groups which are based on the voltage coefficient of capacitance, COG/NP0 which has negligible capacitance shift with applied voltage and three subgroups of X7R. Type A with  $\pm 30\%$  maximum capacitance shift 0V-240V, Type B with  $+30\%$  to  $-50\%$  maximum capacitance shift 0V-240V and Type C with  $+30\%$  to  $-80\%$  maximum capacitance shift 0V to 240V.

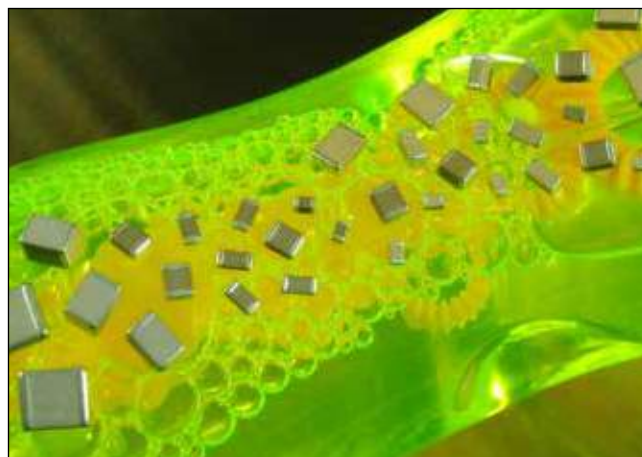

## 250Vac Rated 50/60Hz AC capacitors - minimum/maximum capacitance values

Chip size	0805	1206	1210	1808	1812	2220
COG/NP0	1.0pF - 470pF	1.0pF - 1.2nF	4.7pF - 2.2nF	4.7pF - 2.2nF	10pF - 5.6nF	10pF - 10nF
X7R A $\pm 30\%$	560pF - 1.5nF	1.5nF - 10nF	2.7nF - 22nF	2.7nF - 22nF	6.8nF - 56nF	12nF - 120nF
X7R B $+30\%$ -50%	1.8nF - 3.3nF	12nF	27nF	27nF	68nF - 82nF	-
X7R C $+30\%$ -80%	3.9nF - 10nF	15nF - 47nF	33nF - 100nF	33nF - 100nF	100nF - 120nF	-

Note: X7R A) has a VCC of  $\pm 30\%$  over 0 to 240Vac 60Hz

X7R B) has a VCC of  $+30\%$  to  $-50\%$  over 0 to 240Vac 60Hz

X7R C) has a VCC of  $+30\%$  to  $-80\%$  over 0 to 240Vac 60Hz

Measurement conditions described in Knowles Application Notes AN0033. Please see our website [www.knowlescapacitors.com](http://www.knowlescapacitors.com) for further details.

## Ordering information - 250Vac Rated 50/60Hz AC capacitors

1812	Y	A25	0103	K	J	T
Chip size	Termination	Voltage	Capacitance in picofarads (pF)	Capacitance tolerance	Dielectric codes	Packaging
0805 1206 1210 1808 1812 2220	Y = FlexiCap™ termination base with nickel barrier (100% matte tin plating). RoHS compliant. J = Nickel barrier (100% matte tin plating). RoHS compliant. Lead free.	A25 = 250Vac 60Hz	<10pF Insert a P for the decimal point, eg P300 = 0.3pF, 8P20 = 8.2pF. ≥10pF 1st digit is 0. 2nd and 3rd digits are significant figures of capacitance code. The 4th digit is number of 0's following eg. 0103 = 10nF	<10pF B = $\pm 0.1\text{pF}$ C = $\pm 0.25\text{pF}$ D = $\pm 0.5\text{pF}$ ≥10pF F = $\pm 1\%$ G = $\pm 2\%$ J = $\pm 5\%$ K = $\pm 10\%$ M = $\pm 20\%$	C = COG/NP0 J = X7R (BME) X = X7R	T = 178mm (7") reel R = 330mm (13") reel B = Bulk pack - tubs or trays

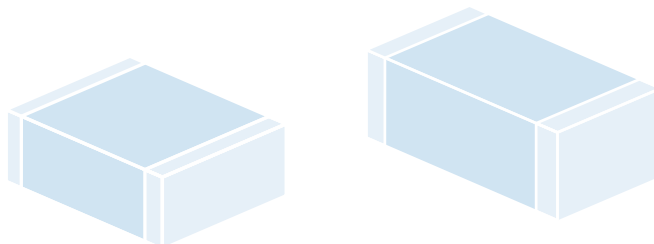

# 250Vac Safety Certified AC Capacitors

Safety Certified capacitors comply with international UL and TÜV specifications to offer designers the option of using a surface mount ceramic multilayer capacitor to replace leaded film types. Offering the benefits of simple pick-and-place assembly, reduced board space required and lower profile, they are also available in a FlexiCap™ version to reduce the risk of mechanical cracking.

Knowles's high voltage capacitor expertise means the range offers among the highest range available of capacitance values in certain case sizes. Applications include: modems, AC-DC power supplies and where lightning strike or other voltage transients represent a threat to electronic equipment.

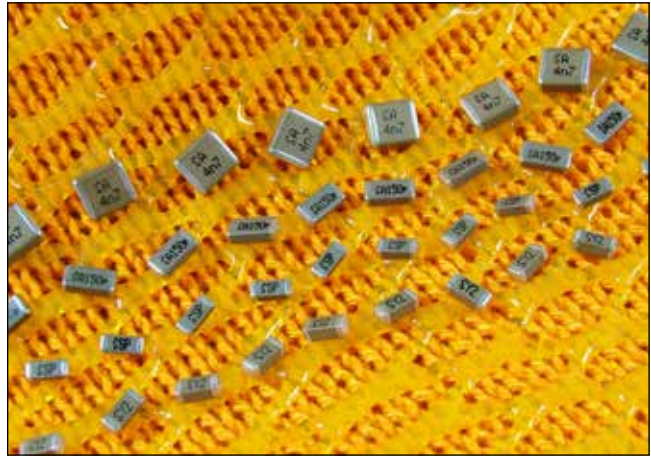

- Surface mount multilayer ceramic capacitors
- Meet Class Y2/X1, X1 and X2 requirements
- Approved for mains ac voltages, up to 250Vac
- Approved by UL and TÜV
- Sizes 1808, 1812, 2211, 2215 and 2220
- Smaller sizes suitable for use in equipment certified to EN60950
- Certification specifications for larger sizes include IEC/EN60384-14, UL/CSA60950 and UL60384-14
- Surface mount package
- Reduces board area and height restrictions
- Reduced assembly costs over conventional through hole components
- FlexiCap™ option available on all sizes

Class	Rated voltage	Impulse voltage	Insulation bridging	May be used in primary circuit
Y1	250Vac	8000V	Double or reinforced	Line to protective earth
Y2	250Vac	5000V	Basic or supplementary*	Line to protective earth
Y4	150Vac	2500V	Basic or supplementary*	Line to protective earth
X1	250Vac	4000V	-	Line to line
X2	250Vac	2500V	-	Line to line
X3	250Vac	None	-	Line to line

\* 2 x Y2 or Y4 rated may bridge double or reinforced insulation when used in series.

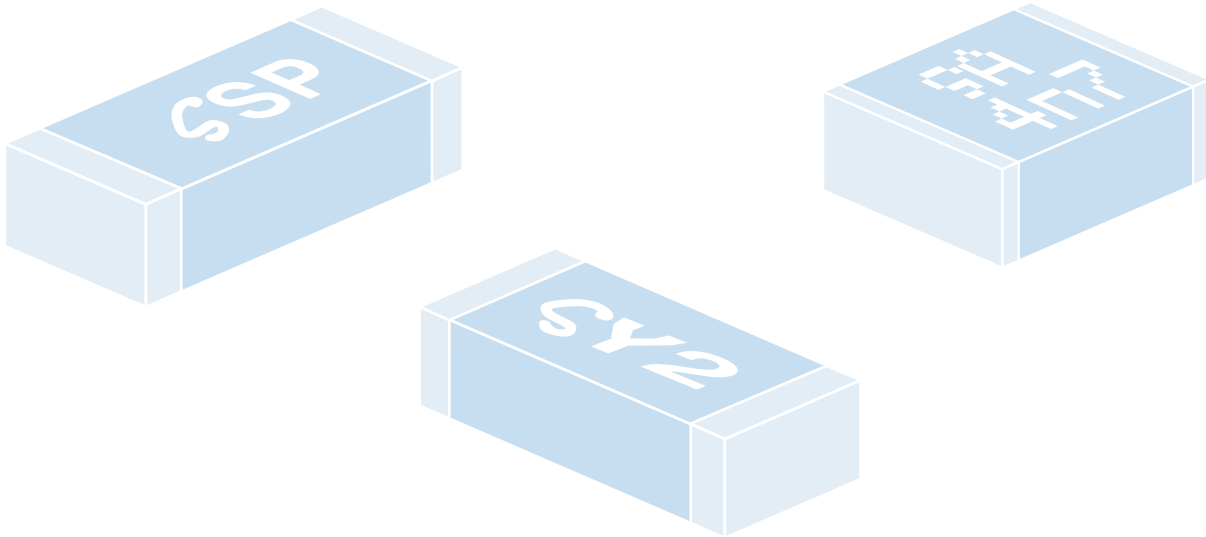

# 250Vac Safety Certified AC Capacitors - Certification Chart

## Classification and approval specification - Safety Certified capacitors

CHIP SIZE	SUFFIX CODE	DIELECTRIC	CAP RANGE	CLASSIFICATION	APPROVAL SPECIFICATION	APPROVAL BODY	AEC-Q200
1808	SP <sup>(1)</sup>	COG/NP0	4.7pF to 1.5nF	X2 NWGQ2, NWGQ8	IEC60384-14 EN60384-14 UL-60950-1, 2nd Ed CSA 60950-1-07 2nd Ed	TÜV UL	TÜV & UL FULL RANGE
1808	SP <sup>(1)</sup>	X7R	150pF to 4.7nF	X2 NWGQ2, NWGQ8	IEC60384-14 EN60384-14 UL-60950-1, 2nd Ed CSA 60950-1-07 2nd Ed	TÜV UL	TÜV & UL FULL RANGE 'Y' TERM ONLY
1808	PY2 <sup>(1)</sup>	COG/NP0	4.7pF to 390pF	X1 NWGQ2, NWGQ8	IEC60384-14 EN60384-14 UL-60950-1, 2nd Ed CSA 60950-1-07 2nd Ed	TÜV UL	TÜV & UL FULL RANGE
1808	PY2 <sup>(1)</sup>	X7R	150pF to 1nF	X1 NWGQ2, NWGQ8	IEC60384-14 EN60384-14 UL-60950-1, 2nd Ed CSA 60950-1-07 2nd Ed	TÜV UL	TÜV & UL 1nF max. 'Y' TERM ONLY
1812	PY2 <sup>(1)</sup>	COG/NP0	4.7pF to 390pF	X1 NWGQ2, NWGQ8	IEC60384-14 EN60384-14 UL-60950-1, 2nd Ed CSA 60950-1-07 2nd Ed	TÜV UL	TÜV & UL FULL RANGE
1812	PY2 <sup>(1)</sup>	X7R	150pF to 2.2nF	X1 NWGQ2, NWGQ8	IEC60384-14 EN60384-14 UL-60950-1, 2nd Ed CSA 60950-1-07 2nd Ed	TÜV UL	TÜV & UL 2.2nF max. 'Y' TERM ONLY
2211	SP <sup>(2)</sup>	COG/NP0	4.7pF to 1nF	Y2/X1 NWGQ2, NWGQ8	IEC60384-14 EN60384-14 UL-60950-1, 2nd Ed CSA 60950-1-07 2nd Ed	TÜV UL	TÜV & UL FULL RANGE
2211	SP <sup>(2)</sup>	X7R	100pF to 3.9nF	Y2/X1 NWGQ2, NWGQ8	IEC60384-14 EN60384-14 UL-60950-1, 2nd Ed CSA 60950-1-07 2nd Ed	TÜV UL	TÜV & UL FULL RANGE 'Y' & 'H' TERM ONLY
2215	SP <sup>(2)</sup>	COG/NP0	820pF to 1.0nF	Y2/X1 NWGQ2, NWGQ8	IEC60384-14 EN60384-14 UL-60950-1, 2nd Ed CSA 60950-1-07 2nd Ed	TÜV UL	TÜV & UL FULL RANGE
2215	SP <sup>(2)</sup>	X7R	2.7nF to 3.9nF	Y2/X1 NWGQ2, NWGQ8	IEC60384-14 EN60384-14 UL-60950-1, 2nd Ed CSA 60950-1-07 2nd Ed	TÜV UL	TÜV & UL FULL RANGE 'Y' & 'H' TERM ONLY
2220	B16 <sup>(3)</sup>	X7R	150pF to 10nF	Y2/X1 FOWX2, FOWX8	IEC60384-14 EN60384-14 UL-60384-14:2010 CSA E60384-14:09	TÜV UL	TÜV & UL FULL RANGE 'Y' & 'H' TERM ONLY
2220	B17 <sup>(2)</sup>	X7R	150pF to 22nF	X2	IEC60384-14 EN60384-14	TÜV	TÜV ONLY 22nF max. 'Y' & 'H' TERM ONLY

Notes: Termination availability

(1) J & Y terminations only.

(2) J, Y, A & H terminations available.

(3) J, Y, A & H terminations available on value  $\leq 5.6nF$ . Y & H terminations on 10nF.

PY2 Unmarked capacitors with a dual ac/dc rating are also available as released in accordance with approval specifications. Suffix Code SY2 applies.

SP Unmarked capacitors with a dual ac/dc rating are also available as released in accordance with approval specifications. Suffix Code SPU applies.

B16 \*Un-marked capacitors with a dual ac/dc rating are also available as released in accordance with approval specifications. Suffix Code U16 applies.

B17 \*Un-marked capacitors with a dual ac/dc rating are also available as released in accordance with approval specifications. Suffix Code U17 applies.



# 250Vac Safety Certified AC Capacitors - Ordering Information

## Ordering information - Safety Certified capacitors - Class SPU/SP ranges

1808	J	A25	0102	J	C	T	SP
Chip size	Termination	Voltage	Capacitance in picofarads (pF)	Capacitance tolerance	Dielectric codes	Packaging	Suffix code
1808 2211 2215	<p><b>J</b> = Nickel barrier (100% matte tin plating). RoHS compliant. Lead free.</p> <p><b>Y</b> = FlexiCap™ termination base with nickel barrier (100% matte tin plating). RoHS compliant.</p> <p><b>2211/2215 only</b></p> <p><b>A</b> = Nickel barrier (Tin/lead plating with min. 10% lead). Not RoHS compliant.</p> <p><b>H</b> = FlexiCap™ termination base with nickel barrier (Tin/lead plating with minimum 10% lead). Not RoHS compliant.</p>	<b>A25</b> = 250Vac (250Vac/2500Vdc for SPU only).	<p>First digit is 0. Second and third digits are significant figures of capacitance code. The fourth digit is number of zeros following.</p> <p>Example: <b>0102</b> = 1.0nF</p>	<p>&lt;10pF <b>B</b> = ±0.10pF <b>C</b> = ±0.25pF <b>D</b> = ±0.50pF</p> <p>≥10pF <b>F</b> = ±1% <b>G</b> = ±2% <b>J</b> = ±5% <b>K</b> = ±10% <b>M</b> = ±20%</p>	<p><b>C</b> = C0G/NP0 <b>X</b> = X7R</p> <p><b>A</b> = C0G/NP0 (1B/NP0) AEC-Q200</p> <p><b>E</b> = X7R (2B1) AEC-Q200</p>	<p><b>T</b> = 178mm (7") reel <b>R</b> = 330mm (13") reel</p> <p><b>B</b> = Bulk pack - tubs or trays</p>	<p><b>SP</b> = Surge Protection capacitors (marked and approved)</p> <p><b>SPU</b> = Surge Protection capacitors (un-marked parts with a dual ac/dc rating are in accordance with but not certified)</p>



## Ordering information - Safety Certified capacitors - Class PY2/SY2

1808	J	A25	0102	J	X	T	PY2
Chip size	Termination	Voltage	Capacitance in picofarads (pF)	Capacitance tolerance	Dielectric codes	Packaging	Suffix code
1808 1812	<p><b>J</b> = Nickel barrier (100% matte tin plating). RoHS compliant. Lead free.</p> <p><b>Y</b> = FlexiCap™ termination base with nickel barrier (100% matte tin plating). RoHS compliant.</p>	<b>A25</b> = 250Vac (250Vac/2500Vdc for SY2 only).	<p>First digit is 0. Second and third digits are significant figures of capacitance code. The fourth digit is number of zeros following.</p> <p>Example: <b>0102</b> = 1.0nF</p>	<p>&lt;10pF <b>B</b> = ±0.10pF <b>C</b> = ±0.25pF <b>D</b> = ±0.50pF</p> <p>≥10pF <b>F</b> = ±1% <b>G</b> = ±2% <b>J</b> = ±5% <b>K</b> = ±10% <b>M</b> = ±20%</p>	<p><b>C</b> = C0G/NP0 <b>X</b> = X7R</p> <p><b>A</b> = C0G/NP0 (1B/NP0) AEC-Q200</p> <p><b>E</b> = X7R (2B1) AEC-Q200</p>	<p><b>T</b> = 178mm (7") reel <b>R</b> = 330mm (13") reel</p> <p><b>B</b> = Bulk pack - tubs or trays</p>	<p><b>PY2</b> = Safety tested Surge Protection capacitors (marked and approved)</p> <p><b>SY2</b> = Surge Protection capacitors (un-marked parts with a dual ac/dc rating are in accordance with but not certified)</p>



## Ordering information - Safety Certified capacitors - Class B16/B17 ranges

2220	J	A25	0102	J	X	T	B16
Chip size	Termination	Voltage	Capacitance in picofarads (pF)	Capacitance tolerance	Dielectric codes	Packaging	Suffix code
2220	<p><b>J</b> = Nickel barrier (100% matte tin plating). RoHS compliant. Lead free.</p> <p><b>Y</b> = FlexiCap™ termination base with nickel barrier (100% matte tin plating). RoHS compliant.</p> <p><b>A</b> = Nickel barrier (Tin/lead plating with min. 10% lead). Not RoHS compliant.</p> <p><b>H</b> = FlexiCap™ termination base with nickel barrier (Tin/lead plating with minimum 10% lead). Not RoHS compliant.</p>	<b>A25</b> = 250Vac (250Vac/2500Vdc for U16 & U17 only).	<p>First digit is 0. Second and third digits are significant figures of capacitance code. The fourth digit is number of zeros following.</p> <p>Example: <b>0102</b> = 1.0nF</p>	<p><b>J</b> = ±5% <b>K</b> = ±10% <b>M</b> = ±20%</p>	<p><b>X</b> = X7R <b>E</b> = X7R (2B1) AEC-Q200</p>	<p><b>T</b> = 178mm (7") reel <b>R</b> = 330mm (13") reel</p> <p><b>B</b> = Bulk pack - tubs or trays</p>	<p><b>B16</b> = Type A: X<sup>1</sup>/Y<sup>2</sup> <b>B17</b> = Type B: X<sup>2</sup></p> <p><b>U16</b> = Surge protection *Un-marked Type A X1/Y2 capacitors (with a dual ac/dc rating are in accordance with but not certified)</p> <p><b>U17</b> = Surge protection *Un-marked Type B X2 capacitors (with a dual ac/dc rating are in accordance with but not certified)</p>



# Non-Magnetic Capacitors - High Q, COG/NP0, X7R - 16V to 7.2kV

MLC capacitors with silver/palladium (Ag/Pd) terminations have often been used in medical applications where non-magnetic components are required, for example in MRI equipment - however, conventional nickel barrier terminations are not suitable due to their magnetic properties. In addition, RoHS requirement to use lead-free solders would cause an increase in soldering temperatures and cause solder leaching problems for the Ag/Pd termination. This has meant alternatives have had to be found and one solution is to use a copper barrier instead of a nickel barrier, with a tin finish on top. This non-magnetic termination is offered with selected non-magnetic COG/NP0, High Q and X7R dielectrics, providing a fully non-magnetic component ( $\mu_r = 1.0000$ ).

To meet high temperature 260°C soldering reflow profiles as detailed in J-STD-020, COG/NP0 dielectrics are supplied with FlexiCap™ or sintered termination whilst X7R dielectrics are supplied only with the FlexiCap™ termination.

Available in chip or ribbon led format for certain case sizes (consult sales office).



## High Q, COG/NP0 - minimum/maximum capacitance values

Chip Size	0402	0603	0505	0805	1206	1210	1808	1812	2220
Min Cap	0.1pF	0.1pF	0.2pF	0.2pF	0.5pF	0.3pF	1.0pF	1.0pF	2.0pF
50V 63V	22pF	100pF	220pF	470pF	1.5nF	-	-	-	-
100V	15pF	68pF	150pF	330pF	1.0nF	2.2nF	2.2nF	4.7nF	10nF
150V	10pF	47pF	100pF	220pF	680pF	1.5nF	1.5nF	3.3nF	6.8nF
200V 250V	6.8pF	33pF	56pF	150pF	470pF	1.0nF	1.0nF	2.2nF	4.7nF
300V	-	27pF	47pF	120pF	390pF	820pF	820pF	1.8nF	3.9nF
500V				68pF	270pF	680pF	680pF	1.5nF	3.3nF
630V				-	150pF	390pF	390pF	1.0nF	2.2nF
1000V				-	82pF	220pF	220pF	680pF	1.5nF
2000V				-	18pF	68pF	68pF	150pF	470pF
3000V				-	-	-	-	68pF	150pF

Min Capacitance Tolerance  
 $\pm 0.05\text{pF}$  ( $< 4.7\text{pF}$ )  
 $0.1\text{pF}$  ( $\geq 4.7\text{pF}$  &  $< 10\text{pF}$ )  
 $\pm 1\%$  ( $\geq 10\text{pF}$ )

## X7R - minimum/maximum capacitance values

Chip Size	0402	0603	0805	1206	1210	1808	1812	2220
Min Cap	47pF	100pF	330pF	680pF	1.5nF	2.2nF	3.3nF	6.8nF
16V	10nF	100nF	330nF	1.0 $\mu\text{F}$	1.5 $\mu\text{F}$	1.5 $\mu\text{F}$	3.3 $\mu\text{F}$	5.6 $\mu\text{F}$
25V	6.8nF	68nF	220nF	820nF	1.2 $\mu\text{F}$	1.2 $\mu\text{F}$	2.2 $\mu\text{F}$	4.7 $\mu\text{F}$
50V 63V	4.7nF	47nF	150nF	470nF	1.0 $\mu\text{F}$	680nF	1.5 $\mu\text{F}$	3.3 $\mu\text{F}$
100V	1.5nF	10nF	47nF	150nF	470nF	330nF	1.0 $\mu\text{F}$	1.5 $\mu\text{F}$
200V 250V	680pF	5.6nF	27nF	100nF	220nF	180nF	470nF	1.0 $\mu\text{F}$
500V	-	1.5nF	8.2nF	33nF	100nF	100nF	270nF	560nF
630V			4.7nF	10nF	27nF	33nF	150nF	330nF
1000V			3.3nF	4.7nF	15nF	18nF	56nF	120nF
1200V			-	3.3nF	10nF	10nF	33nF	82nF
1500V			-	2.7nF	6.8nF	6.8nF	22nF	47nF
2000V			-	2.2nF	4.7nF	4.7nF	10nF	27nF

Min Capacitance Tolerance  
 $\pm 5\%$

## High Q, COG/NP0 High Power RF capacitors - minimum/maximum capacitance values

A range of ultra-low loss High Q ceramic capacitors with COG/NP0 characteristics suitable for high power applications where minimal power loss and very low self heating is demanded.

Common applications include MRI body coils and wireless charging systems operating in the kHz and MHz frequencies.

Available in chip or ribbon led format.

Chip size	Case size 11 - 1111		Case size 25 - 2225		Case size 40 - 4040	
	Min.	Max.	Min.	Max.	Min.	Max.
100V	1.8nF	2.2nF				
150V	1.2nF	1.5nF				
200V	5.7nF	10nF	6.2nF	10nF	16nF	27nF
250V	820pF	1.0nF				
500V	470pF	680pF	5.1nF	5.6nF	13nF	15nF
630V	270pF	390pF	3.6nF	4.7nF	11nF	12nF
1kV	82pF	220pF	1.1nF	3.3nF	5.6nF	10nF
2kV	0.3pF	68pF	510pF	1.0nF	1.6nF	5.1nF
3kV			110pF	470pF	910pF	1.5nF
3.6kV			1pF	47*/100pF	-	-
4kV					620pF	820pF
5kV					360pF	560pF
6kV					160pF	330pF
7.0/7.2kV					1pF	56**/150pF

\*47pF max. for dual rated @2.5kVac 30MHz  
 \*\*56pF max. for dual rated @5kVac 30MHz.



# Non-Magnetic Capacitors - High Q, C0G/NP0, X7R - 16V to 7.2kV

**Surface Mount** See page 20 for dimensions

**Ribbon Leaded** Silver plated copper ribbon attached with HMP solder - (MP greater than 260°C)

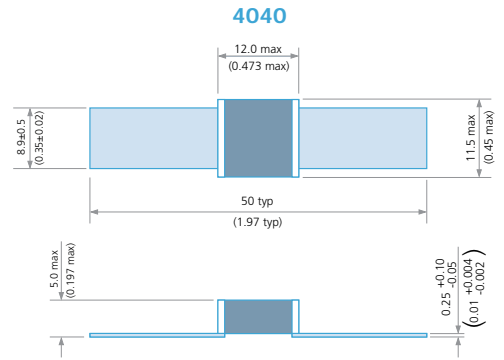
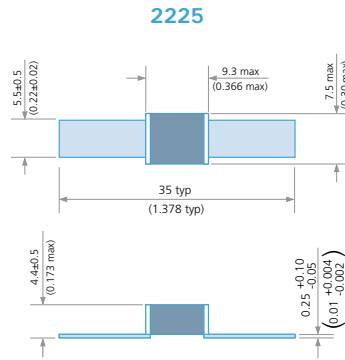
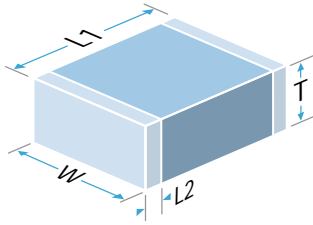

## Ordering information - Syfer Non-Magnetic capacitors

1206	2	500	0223	J	Q	T	-	-
4040	2	7K0	0470	G	Q	B	-	AF9
2225	B	3K0	6P80	G	Q	B	R	W221
Chip size	Termination or Coating (Ribbon Leaded)	Voltage	Capacitance in picofarads (pF)	Capacitance tolerance	Dielectric	Packing	Lead Options	Suffix code
0402*	2 = Sintered silver with copper barrier*	50 = 50V	<10pF Insert a P for the decimal point, eg 2P20 = 2.2pF.	<4.7pF H = ±0.05pF B = ±0.1pF C = ±0.25pF D = ±0.5pF	C = C0G/NP0 (1B) Q = High Q X = X7R (2R1)	T = 178mm (7") reel R = 330mm (13") reel B = Bulk pack - tubs or trays	R = Ribbon leaded Blank = SM chip	W221 = Leaded W211 = Leaded marked **AF9 = SM standard chip **AF9LM = SM marked standard chip
0603	3 = FlexiCap™ with copper barrier.	100 = 100V	>10pF. 1st digit is 0. 2nd and 3rd digits are significant figures of capacitance code. The 4th digit is number of 0's following	≥4.7pF ~ <10pF B = ±0.1pF C = ±0.25pF D = ±0.5pF				
0505	4 = Sintered silver with copper barrier*	1K0 = 1kV						
0805	5 = FlexiCap™ base with copper barrier.	2K0 = 2kV						
1206		3K0 = 3kV						
1111		4K0 = 4kV						
1210		5K0 = 5kV						
1808		6K0 = 6kV						
1812		7K0 = 7kV						
2220	<b>Ribbon Leaded</b>							
2225†	B = Uncoated							
4040†	V = Coated with modified silicone laquer		Values <1pF in 0.1pF steps, above this values are E24 series	≥10pF F = ±1% G = ±2% J = ±5% K = ±10% M = ±20%				

Note: \*0402 - C0G/NP0 and High Q only. †Ribbon Leads available. \*\*AF9 and AF9LM suffix code only available in 1111, 2225 and 4040 chip sizes.

## Ordering information - Voltronics Non-Magnetic capacitors

11	470	J	1000	W	F	R
Chip size	Capacitance	Tolerance	Voltage	Termination	Material	Lead/Packaging
4 0402*	OR1 0.1pF	A ±0.05pF	50 = 50V	W = Ag/Cu/Sn	Q = High Q	R = Ribbon
5 0505	100 10pF	B ±0.1pF	100 = 100V	S = Pd/Ag	0±30ppm/°C	T* = Tape & Reel
6 0603*	101 100pF	C ±0.25pF	1000 = 1000V	M = Poly/Cu/Sn	X = X7R (2R1)	B* = Bulk
8 0805*	102 1000pF	D ±0.5pF		2 = Ag/Cu/Sn - (Q dielectric only)		
11 1111†		F ±1%		3 = Poly/Cu/Sn - (X dielectric only)		
12 1206*		G ±2%		B = Silver - (Q ribbon only)		
13 1210*		J ±5%		V = Silver, laquer Coated - (Q ribbon only)		
18 1812*		K ±10%				
22 2220*		M ±20%				
25 2225†						
38 3838†						
40 4040†						

Note: \*Q and X dielectric only. †Ribbon Leads available.



# Non-Magnetic Capacitors, High Power RF - Porcelain High Q

Made from highly stable, low loss dielectric formulations, these traditional porcelain MLCs are known for their high RF power handling capability. Available in all industry common case sizes. The special silver-palladium termination and the proprietary ceramic formulations guarantee consistent non-magnetic performance. All MLCs in these series are RoHS compliant. Chips are available either with standard termination or can be fitted with ribbon leads, depending on your application.

## Description

- Porcelain Capacitors • Zero TC • Low Noise • Low ESR, High Q
- High Self-resonance • Established Reliability
- Capacitance range 0.1pF to 5.1nF

## Functional Applications

- Impedance Matching • DC Blocking • Bypass • Coupling
- Tuning and Feedback



## High Power RF capacitors - F & H materials - Minimum/maximum capacitance values - see ordering information

Chip Size	Case size 5 0505		Case size 11 1111		Case size 25 2225		Case size 38 3838	
	Min.	Max.	Min.	Max.	Min.	Max.	Min.	Max.
50V	-	-	680pF	1nF	-	-	-	-
100V	-	-	510pF	620pF	-	-	-	-
200V	36pF	100pF	220pF	470pF	-	-	-	-
250V	0.1pF	33pF	-	-	-	-	-	-
300V	-	-	-	-	2.2nF	2.7nF	-	-
500V	-	-	110pF	200pF	1.5nF	1.8nF	2.7nF	5.1nF
1kV	-	-	0.3pF	100pF	510pF	1.2nF	750pF	2.2nF
1.5kV	-	-	-	-	300pF	470pF	-	-
2kV	-	-	-	-	-	-	-	-
2.5kV	-	-	-	-	0.3pF	270pF	430pF	680pF
3.6kV	-	-	-	-	-	-	110pF	390pF
7.2kV	-	-	-	-	-	-	0.3pF	100pF

Note: Special capacitance values available upon request.

## Ordering information - Non-Magnetic capacitors

11	470	J	1000	W	F	R
Chip size	Capacitance	Tolerance	Voltage	Termination	Material	Lead
5 0505	OR1 0.1pF	A ±0.05pF	50 50V	W Ag/Cu/Sn	H AH +90±20ppm/°C	B = Chip
11 1111†	100 10pF	B ±0.1pF	100 100V	S Pd/Ag	F CF 0±15ppm/°C	R =Ribbon
25 2225†	101 100pF	C ±0.25pF	1000 1000V	M Poly/Cu/Sn		
38 3838†	102 1000pF	D ±0.5pF				
		F ±1%				
		G ±2%				
		J ±5%				
		K ±10%				

Note: †Available in chip or ribbon leaded format.

## Reeled Quantities

Chip Size	0402	0505	0603	0805	1206	1111 1210	1808	1812	2220	2225
7" Reel	10000	2500	4000	3000	2500	1000/2000	1500	500	500	500
13" Reel	13" reel quantities available on request						6000	2000	2000	2000

Note: Other capacitance values may become available, please contact the Sales Office if you need values other than those shown in the above tables. For dimensions and soldering information, please go to our website [www.knowlescapacitors.com](http://www.knowlescapacitors.com).

# Non-Magnetic Capacitors - High Q, X7R

Typical performance data - chip size 0805 High Q

Typical performance data - chip size 1111 High Q



ESR vs Frequency

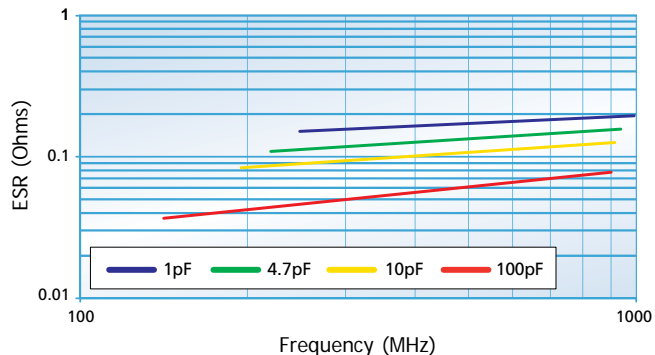

ESR vs Frequency

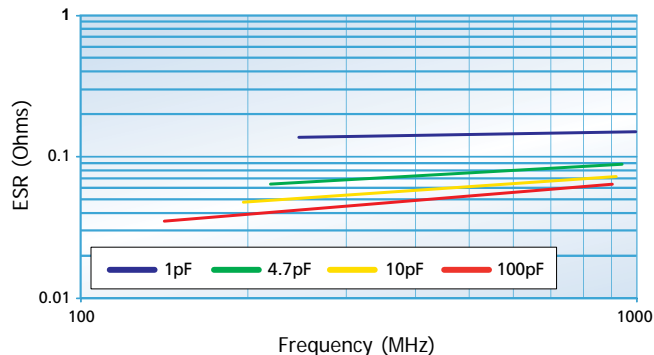

Q vs Capacitance

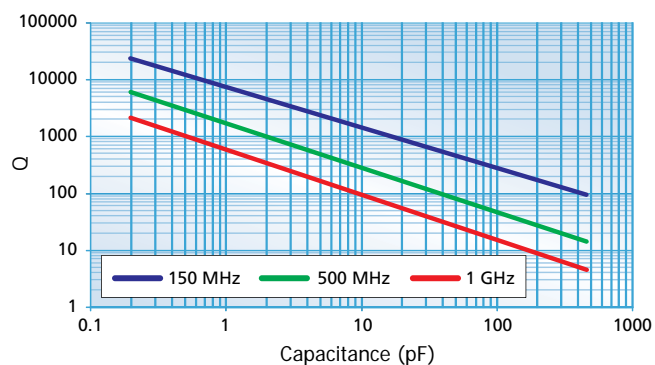

Q vs Capacitance

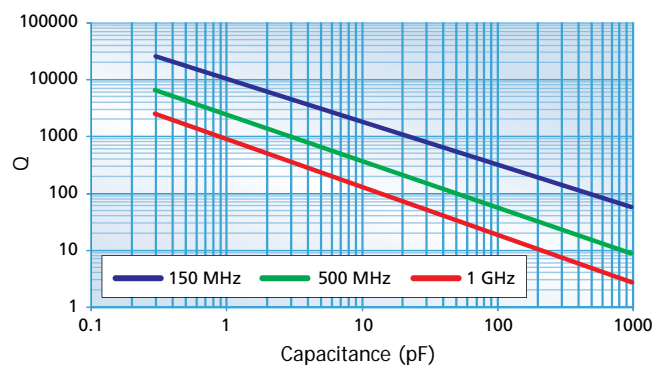

Resonant Frequency vs Capacitance

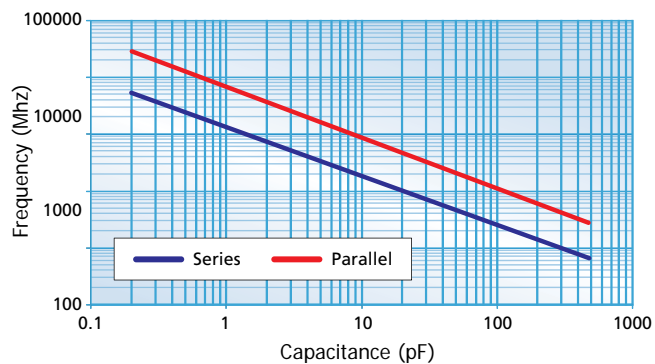

Resonant Frequency vs Capacitance

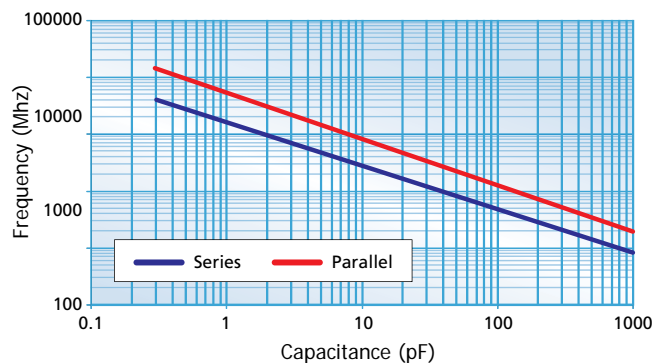

Typical ESR vs Frequency

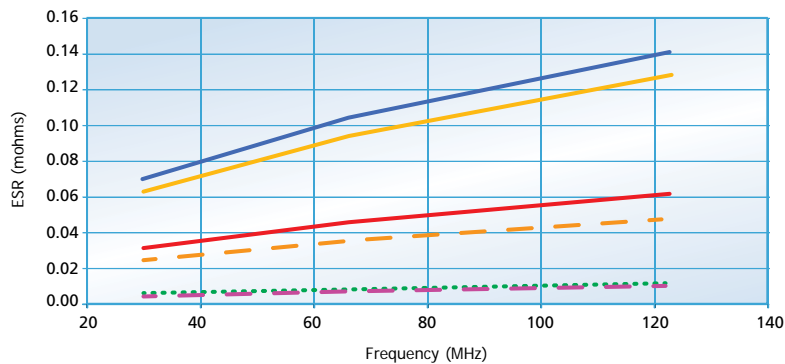

- 4040 56pF
- 4040 18pF
- ... 2225 2.2nF
- 2225 39pF
- 2225 10pF
- - - 4040 5.1nF

### ESR Measurement

All ESR figures are measured using a VNA and 2m copper resonant tube and extrapolating to 30MHz by ratio. Measured data can be supplied on request. Measurement of ESR can vary with test method and components should only be compared when tested back-to-back on the same equipment under controlled conditions.

# 115Vac 400Hz Capacitors - COG/NPO, X7R

## 115Vac 400Hz capacitors for aerospace applications

Knowles has conducted reliability testing on standard surface mount ceramic capacitors in order to ensure their performance at 115Vac 400Hz and the associated voltage and frequency transients required by MIL-STD-704. Self heating will occur due to losses in the capacitor but has been measured at less than 25°C rise with neutral mounting conditions at room temperature.

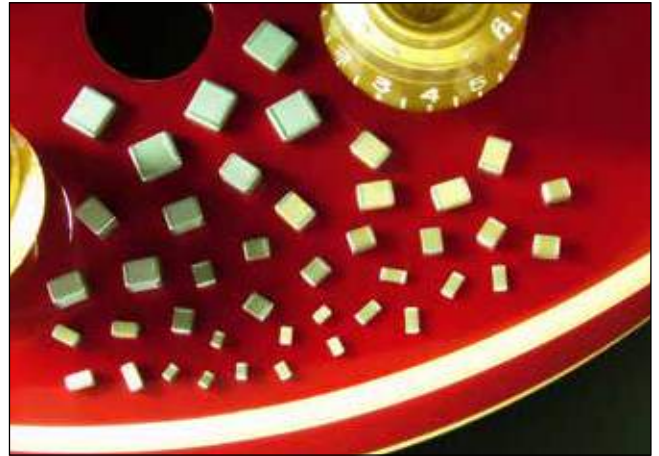

## 115Vac 400Hz Capacitors - minimum/maximum capacitance values

	0805	1206	1210	1808	1812	2220
<b>Dielectric</b>	<b>Maximum capacitance values</b>					
<b>COG/NPO</b>	1pF - 330pF	1pF - 1.5nF	3.9pF - 3.9nF	4.7pF - 3.9nF	10pF - 10nF	10pF - 15nF
<b>X7R</b>	100pF - 4.7nF	100pF - 18nF	100pF - 39nF	100pF - 39nF	150pF - 82nF	220pF - 100nF

## Ordering information - 115Vac 400Hz Capacitors

1206	Y	A12	0103	J	X	T
Chip size	Termination	Voltage	Capacitance in picofarads (pF)	Capacitance tolerance	Dielectric codes	Packaging
0805 1206 1210 1808 1812 2220	<p><b>Y</b> = FlexiCap™ termination base with nickel barrier (100% matte tin plating). RoHS compliant.</p> <p><b>H</b> = FlexiCap™ termination base with nickel barrier (Tin/lead plating with min. 10% lead). Not RoHS compliant.</p> <p><b>J</b> = Nickel barrier (100% matte tin plating). RoHS compliant. Lead free.</p> <p><b>A</b> = Nickel barrier (Tin/lead plating with min. 10% lead). Not RoHS compliant.</p>	<b>A12</b> = 115Vac	<p>First digit is 0. Second and third digits are significant figures of capacitance code. The fourth digit is number of zeros following.</p> <p>Example: <b>0103</b> = 10nF</p>	<p>&lt;4.7pF <b>H</b> = ±0.05pF <b>B</b> = ±0.10pF <b>C</b> = ±0.25pF <b>D</b> = ±0.50pF</p> <p>≥4.7pF &amp; &lt;10pF <b>B</b> = ±0.10pF <b>C</b> = ±0.25pF <b>D</b> = ±0.50pF</p> <p>≥10pF <b>F</b> = ±1% <b>G</b> = ±2% <b>J</b> = ±5% <b>K</b> = ±10% <b>M</b> = ±20%</p>	<p><b>C</b> = COG/NPO <b>X</b> = X7R</p>	<p><b>T</b> = 178mm (7") reel <b>R</b> = 330mm (13") reel <b>B</b> = Bulk pack - tubs or trays</p>



# DWV Chip range - COG/NP0, X7R

## High Dielectric Withstand Voltage capacitors (DWV range)

The DWV range is specifically designed for use in applications where a high Dielectric Withstand Voltage (DWV) is required.

These parts have a continuous rated voltage of 500Vdc minimum and are 100% DWV tested at the specified voltages to ensure Flashover (arcing) across the surface does not occur.

- High dielectric withstand voltages (DWV) of 1.5kV and 2.5kV
- These ratings are based on an application of the DWV voltage for a period of up to 60 seconds (where the charging current is limited to 50mA)
- Case sizes: 1206, 1210, 1808, 1812, 2220 and 2225
- COG/NP0 and X7R dielectrics
- Capacitance values from 4.7pF to 120nF



## DWV Capacitors - minimum/maximum capacitance range

		1206	1210	1808	1812	2220	2225
1.5kV	COG/NP0	4.7pF - 330pF	4.7pF - 1nF	4.7pF - 1.2nF	10pF - 2.2nF	100pF - 4.7nF	100pF - 5.6nF
	X7R	4.7pF - 3.9nF	4.7pF - 10nF	4.7pF - 12nF	10pF - 33nF	100pF - 100nF	100pF - 120nF
2.5kV	COG/NP0	4.7pF - 220pF	4.7pF - 560pF	4.7pF - 1nF	10pF - 1.5nF	100pF - 3.3nF	100pF - 3.9nF
	X7R	4.7pF - 1nF	4.7pF - 2.2nF	4.7pF - 2.7nF	10pF - 5.6nF	10pF - 15nF	100pF - 18nF

## Ordering information - DWV Capacitors

1812	J	1K5	0820	K	C	T	DWV
Chip size	Termination	Dielectric Withstand Voltage	Capacitance in picofarads (pF)	Capacitance tolerance	Dielectric codes	Packaging	Suffix code
1206 1210 1808 1812 2220 2225	Y = FlexiCap™ termination base with nickel barrier (100% matte tin plating). RoHS compliant. J = Nickel barrier (100% matte tin plating). RoHS compliant. Lead free.	1K5 = 1.5kV 2K5 = 2.5kV	First digit is 0. Second and third digits are significant figures of capacitance code. The fourth digit is number of zeros following. Example: 0820 = 82pF	<10pF B = ±0.10pF C = ±0.25pF D = ±0.50pF ≥10pF F = ±1% G = ±2% ≥10pF J = ±5% K = ±10% M = ±20%	C = COG/NP0 X = X7R	T = 178mm (7") reel R = 330mm (13") reel B = Bulk pack - tubs or trays	Dielectric Withstand Voltage

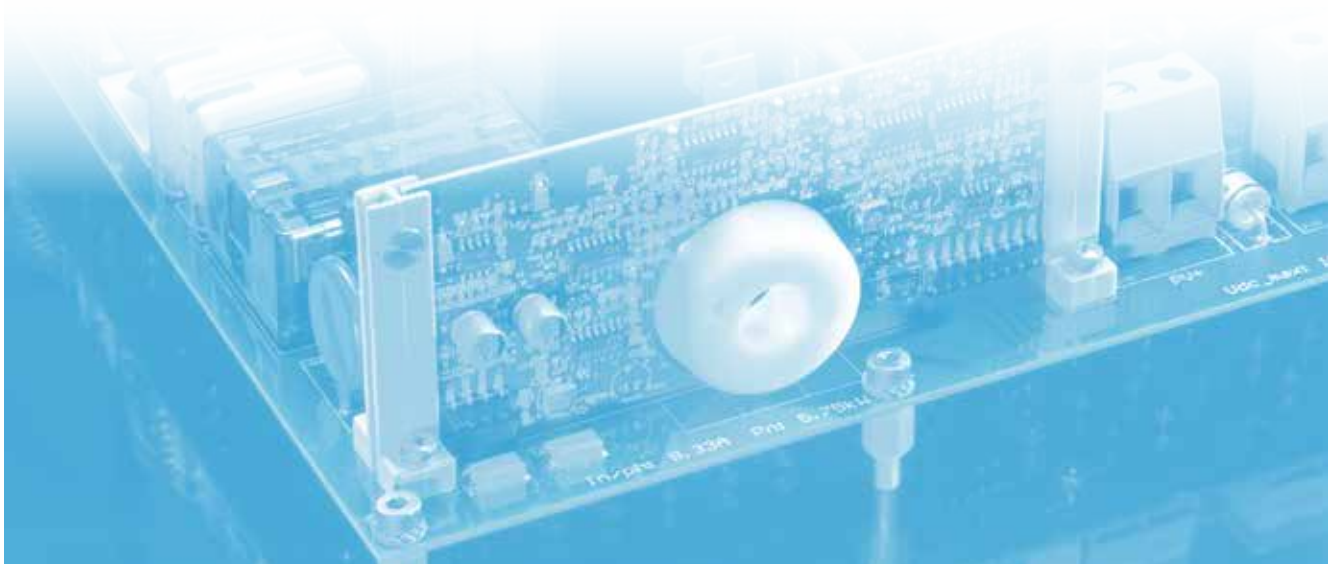

# High Temperature Caps - up to 150°C X8R, Commercial, AEC-Q200

The X8R dielectric will operate from -55°C to +150°C, with a maximum capacitance change  $\pm 15\%$  (without applied voltage).

The devices are available in sizes 0805 to 2225, with voltage ranges from 25V to 3kV and capacitance values from 100pF to 2.2 $\mu$ F.

The capacitors have been developed by Knowles to meet demand from various applications in the automotive and industrial markets and in other electronic equipment exposed to high temperatures. The increased use of electronics in automotive "under the hood" applications has created demand for this product range.

The X8R range incorporates a specially formulated termination with a nickel barrier finish that has been designed to enhance the mechanical performance of these SMD chip capacitors in harsh environments typically present in automotive applications.



## Capacitance Range

100pF to 2.2 $\mu$ F (0805 to 2225)

## Temperature Coefficient of Capacitance (TCC)

$\pm 15\%$  from -55°C to +150°C

## Dissipation Factor (DF)

$\leq 0.025$

## Termination

Nickel Barrier Tin Plated

## Insulation Resistance (IR)

100G  $\Omega$  or 1000secs (whichever is the less).

## Dielectric Withstand Voltage (DWV)

2.5 x rated voltage for 5 $\pm$ 1 seconds, 50mA charging current maximum.

## Ageing Rate

1% per decade (typical)

X8R High Temperature Capacitors - minimum/maximum cap. values according to the rated d.c. voltage

	0805	1206	1210	1808	1812	2220	2225	4540*	7565*
Min cap	100pF	100pF	100pF	100pF	150pF	220pF	330pF	1nF	2.2nF
Min cap	220pF	220pF	220pF	220pF	220pF	220pF	330pF	5.6 $\mu$ F	15 $\mu$ F
50V	47nF	150nF	330nF	330nF	680nF	1.2 $\mu$ F	2.2 $\mu$ F	4.7 $\mu$ F	12 $\mu$ F
100V	33nF	100nF	220nF	220nF	470nF	1.0 $\mu$ F	1.5 $\mu$ F	3.9 $\mu$ F	10 $\mu$ F
200/250V	15nF	68nF	150nF	150nF	330nF	680nF	1.0 $\mu$ F	2.7 $\mu$ F	6.9 $\mu$ F
500V	4.7nF	22nF	47nF	47nF	120nF	330nF	470nF	1.2 $\mu$ F	3.2 $\mu$ F
630V	2.2nF	10nF	33nF	33nF	68nF	180nF	220nF	-	-
1kV	1.5nF	3.3nF	6.8nF	6.8nF	27nF	68nF	82nF	-	-
1.2kV		2.2nF	5.6nF	5.6nF	15nF	47nF	56nF	-	-
1.5kV		1.5nF	3.3nF	3.3nF	10nF	27nF	33nF	-	-
2kV		680pF	1.5nF	1.5nF	5.6nF	15nF	22nF	-	-
2.5kV				1.2nF	3.3nF	10nF	12nF	-	-
3kV				820pF	2.7nF	5.6nF	6.8nF	-	-

Notes:   = X8R ranges in yellow available as qualified AEC-Q200. \*Only available as Novacap parts, Non-RoHS compliant.

## Ordering information - Syfer X8R High Temperature Capacitors

1206	Y	100	0473	K	N	T
Chip size	Termination	Voltage d.c.	Capacitance in picofarads (pF)	Capacitance tolerance	Dielectric codes	Packaging
0805 1206 1210 1808 1812 2220 2225	Y = FlexiCap™ termination base with nickel barrier (100% matte tin plating).	050 = 50V 100 = 100V 200 = 200V 250 = 250V 500 = 500V 630 = 630V 1K0 = 1kV 1K2 = 1.2kV 1K5 = 1.5kV 2K0 = 2kV 2K5 = 2.5kV 3K0 = 3kV	First digit is 0. Second and third digits are significant figures of capacitance code. The fourth digit is number of zeros following. Example: <b>0473</b> = 47000pF = 47nF	J = $\pm 5\%$ K = $\pm 10\%$ M = $\pm 20\%$	N = X8R T = X8R AEC-Q200 RoHS compliant.	T = 178mm (7") reel R = 330mm (13") reel B = Bulk pack - tubs or trays

## Ordering information - Novacap High Temperature Capacitors

4540	S	125	K	501	N	T	M
Chip size	Dielectric codes	Capacitance in picofarads (pF)	Capacitance tolerance code	Voltage code	Termination codes	Packaging	Marking
0805 1206 1210 1825 2225 4540 7565	S = X8R High Temp. (up to 150°C) Non-RoHS.	Value in Picofarads. Two significant figures, followed by number of zeros: 125 = 1.2nF	J = $\pm 5\%$ (X8R) K = $\pm 10\%$ (Class II) M = $\pm 20\%$ (Class II)	Two significant figures, followed by number of zeros: 250 = 25 Volts 500 = 50 Volts 101 = 100 Volts 251 = 250 Volts 501 = 500 Volts	P = Palladium Silver PR = Palladium Silver* K = Solderable Palladium Silver* N = Nickel Barrier* 100% tin Y = Nickel Barrier* 90% tin, 10% lead C = FlexiCap™/Nickel Barrier* 100% tin D = FlexiCap™/Nickel Barrier* 90% tin, 10% lead S = Solderable Silver* *Indicates RoHS terminations	None = Bulk T = Tape & Reel W = Waffle Pack	None = Unmarked M = Marked

# High Temperature Caps - 160°C, 200°C

A range of chip capacitors, available in sizes 0805 to 7565, designed to operate from -55°C to 160°C, (Class II Dielectric) and from -55°C to 200°C (COG/NPO and Class II Dielectrics). Voltage ratings of 25V to 4kV.

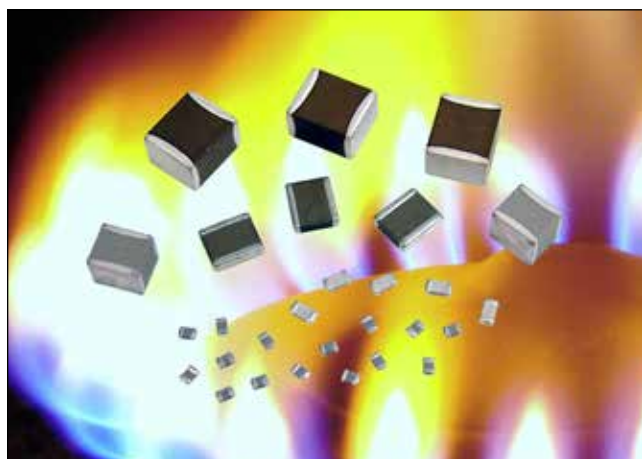

## Maximum capacitance values - 160°C COG (F)/Class II (G) and 200°C COG/NPO (D)/Class II (E) Dielectrics

Size	0805	1206	1210	1515	1808	1812	1825	2225	3530	4540	6560	7565
<b>Tmax</b>	0.054 1.37	0.064 1.63	0.065 1.65	0.130 3.30	0.065 1.65	0.065 1.65	0.080 2.03	0.080 2.03	0.250 6.35	0.300 7.62	0.300 7.62	0.300 7.62

## Maximum capacitance values - COG/NPO - 160°C (F) and 200°C (D)

Min cap.	0R5	1R0	5R0	5R0	120	220	330	470	221	390	560	101
<b>25V</b>	2.7nF	5.6nF	12nF	22nF	12nF	22nF	56nF	56nF	100nF	180nF	330nF	390nF
<b>50V</b>	1.8nF	3.9nF	8.2nF	18nF	8.2nF	15nF	39nF	47nF	82nF	150nF	270nF	330nF
<b>100V</b>	680pF	1.8nF	3.3nF	10nF	3.3nF	8.2nF	15nF	18nF	56nF	100nF	220nF	270nF
<b>250V</b>	180pF	1.0nF	2.2nF	3.9nF	2.2nF	5.6nF	12nF	18nF	33nF	56nF	120nF	150nF
<b>500V</b>	100pF	390pF	820pF	2.7nF	1.0nF	2.2nF	3.9nF	5.6nF	12nF	27nF	56nF	68nF
<b>1kV</b>	47pF	100pF	220pF	820pF	220pF	560pF	820pF	1.0nF	5.6nF	15nF	33nF	39nF
<b>2kV</b>	•	27pF	56pF	180pF	56pF	120pF	180pF	270pF	1.5nF	3.3nF	8.2nF	10nF
<b>3kV</b>	•	•	•	82pF	22pF	56pF	82pF	100pF	560pF	1.5nF	3.3nF	3.9nF
<b>4kV</b>	•	•	•	47pF	12pF	27pF	33pF	47pF	330pF	820pF	1.8nF	2.2nF

## Maximum capacitance values - Class II - 160°C (G) and 200°C (E)

Min cap.	121	121	121	151	151	151	471	471	102	102	222	222
<b>25V</b>	82nF	220nF	390nF	820nF	330nF	680nF	1.5µF	1.8µF	3.9µF	5.6µF	15µF	18µF
<b>50V</b>	47nF	120nF	220nF	680nF	270nF	470nF	1.0µF	1.2µF	2.7µF	4.7µF	12µF	15µF
<b>100V</b>	18nF	47nF	100nF	270nF	82nF	150nF	470nF	470nF	2.2µF	3.3µF	8.2µF	12µF
<b>250V</b>	4.7nF	10nF	27nF	68nF	22nF	47nF	120nF	150nF	560nF	1.2µF	2.7µF	3.9µF
<b>500V</b>	1.0nF	2.2nF	5.6nF	18nF	5.6nF	10nF	27nF	33nF	120nF	330nF	680nF	820nF
<b>1kV</b>	180pF	390pF	820pF	2.7nF	820pF	1.5nF	4.7nF	5.6nF	27nF	68nF	150nF	220nF
<b>2kV</b>	•	•	150pF	560pF	•	220pF	560pF	680pF	6.8nF	18nF	39nF	47nF
<b>3kV</b>	•	•	•	•	•	•	•	•	2.7nF	6.8nF	15nF	18nF
<b>4kV</b>	•	•	•	•	•	•	•	•	1.2nF	2.7nF	5.6nF	8.2nF

## Ordering information - High Temperature Capacitors

1206	G	224	K	250	N	X050	H	T	M
Chip size	Dielectric codes	Capacitance in picofarads (pF)	Capacitance tolerance code	Voltage code	Termination codes	Thickness options	High Reliability Testing	Packaging	Marking
0805 1206 1210 1515 1808 1812 1825 2225 3530 4540 6560 7565	F = COG/NPO High Temp. (up to 160°C) D = COG/NPO High Temp. (up to 200°C) E = Class II High Temp. (up to 200°C) G = Class II High Temp. (up to 160°C)	Value in Picofarads. Two significant figures, by number of zeros: 224 = 220nF (220,000pF)	F = ±1% (COG/NPO) G = ±2% (COG/NPO) J = ±5% (X8R) K = ±10% (Class II) M = ±20% (Class II)	Two significant figures, followed by number of zeros: 250 = 25 Volts	P = Palladium Silver PR = Palladium Silver* K = Solderable Palladium Silver* N = Nickel Barrier* 100% tin Y = Nickel Barrier* 90% tin, 10% lead C = FlexiCap™/Nickel Barrier* 100% tin D = FlexiCap™/Nickel Barrier* 90% tin, 10% lead S = Solderable Silver* *Indicates RoHS terminations Note: Nickel barrier not available in 200°C dielectric	Blank = Standard thickness "X" = Special thickness, specified in inches: X050 = 0.050"	High Temperature Screening	None = Bulk T = Tape & Reel W = Waffle Pack	None = Unmarked M = Marked *Marking not available on sizes <0603

# High Temperature HiT range - 200°C - COG/NPO & X7R

The HiT range of multilayer ceramic capacitors is suitable for a variety of high temperature applications including: oil exploration, geothermal, military, automotive under-hood and avionics.

This range is manufactured to exacting standards using our unique screen printing process. This provides a high quality component suitable for demanding applications.

- 200°C operating temperature
- 0603 to 2220 chip sizes
- COG/NPO and X7R dielectric options
- Capacitance range COG/NPO from 4.7pF up to 47nF
- Capacitance range X7R from 100pF up to 4.7µF
- Voltage ratings from 10V to 630V
- RoHS compliant / Pb Free
- Sn over Ni termination
- Sample kits available

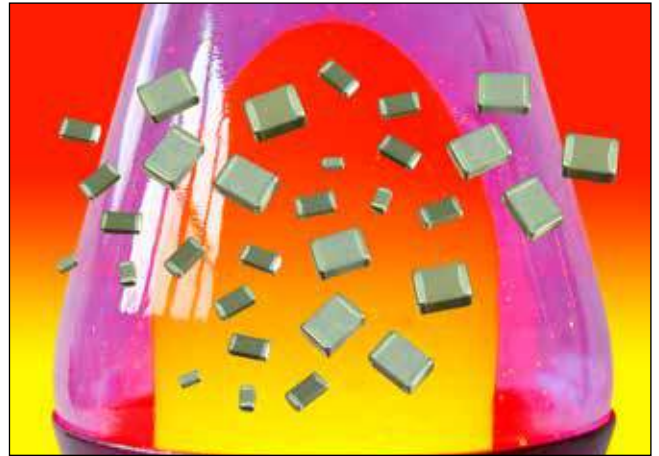

**Temperature Coefficient of Capacitance (TCC)**  
COG/NPO 30ppm/°C to +125°C. X7R ±15% to +125°C

**Ageing Rate**  
COG/NPO Zero. X7R X7R typically less than 2% per time decade.

## Insulation Resistance (IR)

25°C >100GΩ or 1000secs (whichever is the less).

200°C >1GΩ or 10secs (whichever is the less).

## Maximum capacitance values - High Temperature HiT range - 200°C COG/NPO & X7R

Rated Voltage	Chip size													
	0603		0805		1206		1210		1808		1812		2220	
	COG/NPO	X7R	COG/NPO	X7R	COG/NPO	X7R	COG/NPO	X7R	COG/NPO	X7R	COG/NPO	X7R	COG/NPO	X7R
<b>Min Cap</b>	-	100pF	4.7pF	100pF	10pF	100pF	22pF	100pF	22pF	100pF	47pF	150pF	68pF	220pF
<b>10V</b>	-	100nF	1.8nF	220nF	3.9nF	820nF	8.2nF	1.2µF	8.2nF	1.2µF	15nF	2.2µF	47nF	4.7µF
<b>16V</b>	-	100nF	1.8nF	220nF	3.9nF	820nF	8.2nF	1.2µF	8.2nF	1.2µF	15nF	2.2µF	47nF	4.7µF
<b>25V</b>	-	47nF	1.8nF	220nF	3.9nF	820nF	8.2nF	1.2µF	8.2nF	1.2µF	15nF	2.2µF	47nF	4.7µF
<b>50V</b>	-	15nF	1.8nF	100nF	3.9nF	270nF	8.2nF	680nF	8.2nF	560nF	15nF	1.5µF	47nF	2.2µF
<b>100V</b>	-	8.2nF	1.5nF	33nF	3.3nF	100nF	5.6nF	270nF	6.8nF	180nF	12nF	560nF	39nF	1.0µF
<b>200V</b>	-	1.2nF	820pF	6.8nF	1.8nF	27nF	3.9nF	68nF	3.9nF	47nF	10nF	82nF	22nF	120nF
<b>250V</b>	-	820pF	470pF	3.9nF	1.0nF	15nF	2.2nF	47nF	2.2nF	27nF	5.6nF	56nF	12nF	82nF
<b>500V</b>	-	270pF	220pF	1.5nF	820pF	3.9nF	1.5nF	12nF	1.8nF	12nF	4.7nF	18nF	10nF	68nF
<b>630V</b>	-	-	68pF	-	330pF	-	820pF	-	820pF	-	2.7nF	-	6.8nF	-

Note: Other capacitance values may become available, please contact the Sales Office if you need values other than those shown in the above table. For dimensions and soldering information, please go to our website [www.knowlescapacitors.com](http://www.knowlescapacitors.com)

## Ordering information - Novacap Brand - High Temperature HiT range

1206	RE	331	J	501	N	H	T
Case size	Dielectric	Capacitance in picofarads (pF)	Capacitance tolerance	Voltage	Termination	Screening	Packaging
0603 0805 1206 1210 1808 1812 2220	RD = COG/NPO (200°C) RE = X7R (200°C)	First and Second digits are significant figures of capacitance code. The fourth digit is number of 0's following. Example : 103 = 10000pF R = decimal	COG/NPO F = ±1% G = ±2% J = ±5% K = ±10%	X7R J = ±5% K = ±10% M = ±20%	100 = 10V 160 = 16V 250 = 25V 500 = 50V 101 = 100V 201 = 200V 251 = 250V 501 = 500V 631 = 630V	N = Nickel barrier with 100% matte tin plating. RoHS compliant. Lead free.	H = High Temp Screening - if required T = 178mm (7") reel 330mm (13") reel None = Bulk pack - tubs

## Ordering information - Syfer Brand - High Temperature HiT range

1206	J	1K0	0103	M	X	T	H20
Chip size	Termination	Voltage	Capacitance in picofarads (pF)	Capacitance tolerance	Dielectric	Packaging	Suffix Code
0603 0805 1206 1210 1808 1812 2220	J = Nickel barrier with 100% matte tin plating. RoHS compliant. Lead free.	010 = 10V 016 = 16V 025 = 25V 050 = 50V 063 = 63V 100 = 100V 200 = 200V 250 = 250V 500 = 500V 630 = 630V	≥1.0pF & <10pF Insert a P for the decimal point as the second character. e.g., 8P20 = 8.2pF ≥10pF First digit is 0. Second and third digits are significant figures of capacitance code. The fourth digit is the number of zeros following. e.g., 0101 = 100pF	COG/NPO F = ±1% G = ±2% J = ±5% K = ±10%	X7R J = ±5% K = ±10% M = ±20%	G = COG/NPO (BME) X = X7R	T = 178mm (7") reel R = 330mm (13") reel B = Bulk pack - tubs



# Capacitor Assemblies - ST, SM - COG/NP0, X7R

Our complete testing facility is available for any additional military testing requirements. Options available include thru-hole and surface mount lead styles, to make them suitable for mounting on ceramic substrates or epoxy PCBs.

Consult the Sales Office if your specific requirements exceed our catalogue maximums (size, cap. value and voltage).

These ranges of both High Capacitance and High Voltage MLC assemblies are available in COG/NP0 and X7R dielectrics.

Low ESR and Low ESL are inherent in the design giving the assemblies a high capability up to 1MHz and offer far superior performance than either Aluminium or Tantalum electrolytic capacitors.

They are designed for use in high power or high frequency applications such as switched mode power supplies, DC-DC converters, high capacitance discharge circuits and high temperature filtering/decoupling. They can be made with up to five same size chips with various lead configurations to safeguard against thermal and mechanical stresses.

The commercial 'ST' series provide the highest capacitance available and are 100% tested for Dielectric Withstanding Voltage, Insulation Resistance, Capacitance and Dissipation Factor.

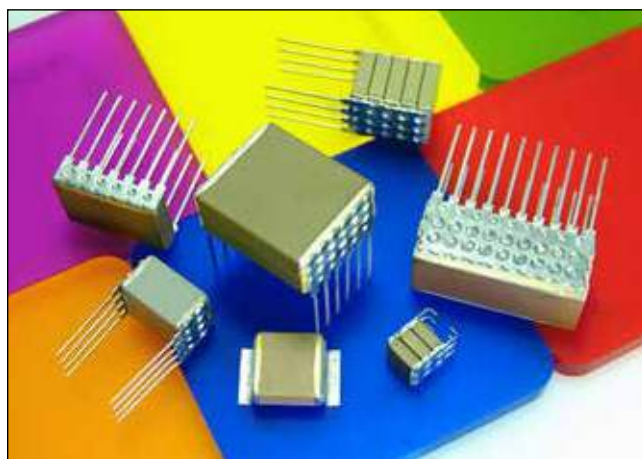

In contrast, the High Reliability 'SM' series is designed and tested for military and industrial applications and tested as per of MIL-PRF-49470 (DSCC 87106), Group A.

## Maximum stack height, X dimension - inches/mm

No. of chips	Chip size	Style NN, NP	Style TJ & TL	Style LN, LJ & LL
1	1812	0.100/2.54	0.180/4.57	N/A
	1825	0.100/2.54	0.180/4.57	0.180/4.57
	2225	0.120/3.05	0.200/5.08	0.200/5.08
	>2225	N/A	0.200/5.08	0.200/5.08
2	1812	0.200/5.08	0.280/7.11	N/A
	1825	0.200/5.08	0.280/7.11	0.280/7.11
	2225	0.240/6.10	0.320/8.13	0.320/8.13
	>2225	N/A	0.320/8.13	0.320/8.13
3	812	0.300/7.62	0.380/9.65	N/A
	1825	0.300/7.62	0.380/9.65	0.380/9.65
	2225	0.360/9.14	0.440/11.2	0.440/11.20
	>2225	N/A	0.440/11.2	0.440/11.20
4	1812	0.400/10.20	0.480/12.2	N/A
	1825	0.400/10.20	0.480/12.2	0.480/12.20
	2225	0.480/12.20	0.560/14.2	0.560/14.20
	>2225	N/A	0.560/14.2	0.560/14.20
5	1812	0.520/13.20	0.600/15.2	N/A
	1825	0.520/13.20	0.600/15.2	0.600/15.2
	2225	0.635/16.10	0.715/18.2	0.715/18.2
	>2225	N/A	0.715/18.2	0.715/18.2

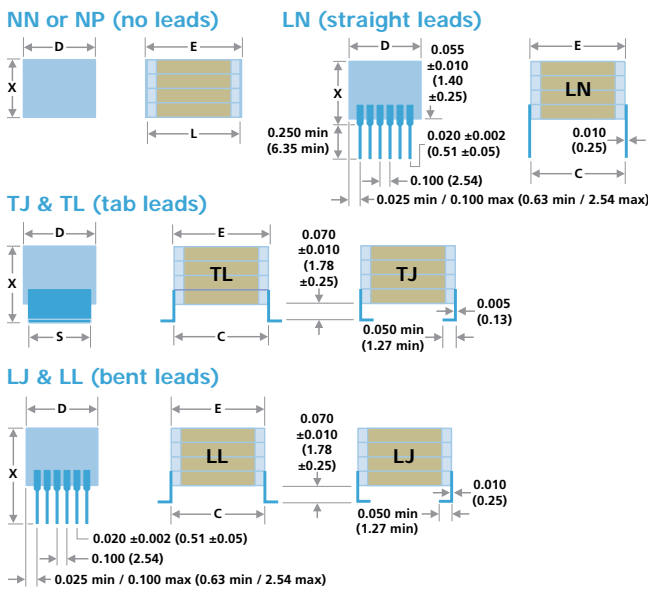

## Dimensions - inches/mm

Size	1812	1825	2225	3640	4540	5550	7565
C*	0.210/ 5.33	0.210/ 5.33	0.250/ 6.35	0.400/ 10.20	0.480/ 12.20	0.580/ 14.70	0.780/ 19.80
D*	0.125/ 3.18	0.250/ 6.35	0.250/ 6.35	0.400/ 10.20	0.400/ 10.20	0.500/ 12.70	0.650**/ 16.50
E max	0.260/ 6.60	0.260/ 6.60	0.300/ 7.62	0.430/ 10.90	0.530/ 13.50	0.630/ 16.00	0.830/ 21.10
L nom	0.180/ 4.57	0.180/ 4.57	0.220/ 5.59	0.360/ 9.14	0.450/ 11.40	0.550/ 14.00	0.750/ 19.10
Leads per side	N/A	3	3	4	4	5	6

Notes: 1) \*C & D inches  $\pm 0.025$  / mm  $\pm 0.64$ ; 2) \*\* $\pm 0.035/0.89$

## Ordering Information - ST & SM Capacitor Assemblies

ST	3640	B	474	M	101	LJ	X	W	-5	R
Style	Size	Dielectric	Capacitance	Tolerance	Voltage-VDCW	Lead style	Thickness option	Packing	No. Chips	RoHS
ST = Commercial SM = High Reliability	See Chart	N = COG/NP0 B = X7R	Value in Picofarads. Two significant figures, followed by number of zeros: 825 = 8,200,000pF (8.2 $\mu$ F)	F = $\pm 1\%*$ B = $\pm 2\%*$ H = $\pm 3\%*$ J = $\pm 5\%$ K = $\pm 10\%$ M = $\pm 20\%$ Z = +80 -20% P = +100 -0%  *COG/NP0 only	Two significant figures, followed by number of zeros: 101 = 100V	LN = Straight* LL = L Lead* LJ = J Lead* TL = L Tab TJ = J tab NN = Nickel NP = Pd/Ag  *Not 1812	Specify standoff dimension if less than max.	W = Waffle T = Tape & Reel*  *Consult the sales office	1 to 5	$\geq 250V$ RoHS



# Capacitor Assemblies - ST, SM - COG/NP0

## COG/NP0 Capacitance and Voltage Selection

Note: Capacitance values are shown as 3 digit code:  
2 significant figures followed by the no. of zeros e.g. 183 = 18,000pF.



4540								5550								6560								7565								Size	
50V		100V		200V		500V		50V		100V		200V		500V		50V		100V		200V		500V		Rated Voltage									
ST	SM	ST	SM	ST	SM	ST	SM	ST	SM	ST	SM	ST	SM	ST	SM	ST	SM	ST	SM	ST	SM	ST	SM	ST	SM	ST	SM	ST	SM	ST	SM	Cap	Code
																																10pF	100
																																12	120
																																15	150
																																18	180
																																22	220
																																27	270
																																33	330
																																39	390
																																47	470
																																56	560
																																68	680
																																82	820
																																100pF	101
																																120	121
																																150	151
																																180	181
																																220	221
																																270	271
																																330	331
																																390	391
																																470	471
																																560	561
																																680	681
																																820	821
																																1.0nF	102
																																1.2	122
																																1.5	152
																																1.8	182
																																2.2	222
																																2.7	272
																																3.3	332
																																3.9	392
																																4.7	472
																																5.6	562
																																6.8	682
																																8.2	822
																																10nF	103
																																12	123
																																15	153
																																18	183
																																22	223
																																27	273
																																33	333
																																39	393
																																47	473
																																56	563
																																68	683
																																82	823
																																100nF	104
																																120	124
																																150	154
																																180	184
																																220	224
																																270	274
																																330	334
																																390	394
																																470	474
																																560	564
																																680	684
																																820	824
																																1.0µF	105
																																1.2	125
																																1.5	155
																																1.8	185
																																2.2	225
																																2.7	275

Number of chips required to achieve the capacitance value

# Capacitor Assemblies - ST, SM - X7R

## X7R Capacitance and Voltage Selection

Size		1812								1825								2225								3640							
Vdc		50V		100V		200V		500V		50V		100V		200V		500V		50V		100V		200V		500V		50V		100V		200V		500V	
Cap	Code	ST	SM	ST	SM	ST	SM	ST	SM	ST	SM	ST	SM	ST	SM	ST	SM	ST	SM	ST	SM	ST	SM	ST	SM	ST	SM	ST	SM	ST	SM	ST	SM
1.0nF	102	1	1	1	1	1	1	1	1	1	1	1	1	1	1	1	1	1	1	1	1	1	1	1	1	1	1	1	1	1	1		
1.2	122	1	1	1	1	1	1	1	1	1	1	1	1	1	1	1	1	1	1	1	1	1	1	1	1	1	1	1	1	1	1		
1.5	152	1	1	1	1	1	1	1	1	1	1	1	1	1	1	1	1	1	1	1	1	1	1	1	1	1	1	1	1	1	1		
1.8	182	1	1	1	1	1	1	1	1	1	1	1	1	1	1	1	1	1	1	1	1	1	1	1	1	1	1	1	1	1	1		
2.2	222	1	1	1	1	1	1	1	1	1	1	1	1	1	1	1	1	1	1	1	1	1	1	1	1	1	1	1	1	1	1		
2.7	272	1	1	1	1	1	1	1	1	1	1	1	1	1	1	1	1	1	1	1	1	1	1	1	1	1	1	1	1	1	1		
3.3	332	1	1	1	1	1	1	1	1	1	1	1	1	1	1	1	1	1	1	1	1	1	1	1	1	1	1	1	1	1	1		
3.9	392	1	1	1	1	1	1	1	1	1	1	1	1	1	1	1	1	1	1	1	1	1	1	1	1	1	1	1	1	1	1		
4.7	472	1	1	1	1	1	1	1	1	1	1	1	1	1	1	1	1	1	1	1	1	1	1	1	1	1	1	1	1	1	1		
5.6	562	1	1	1	1	1	1	1	1	1	1	1	1	1	1	1	1	1	1	1	1	1	1	1	1	1	1	1	1	1	1		
6.8	682	1	1	1	1	1	1	1	1	1	1	1	1	1	1	1	1	1	1	1	1	1	1	1	1	1	1	1	1	1	1		
8.2	822	1	1	1	1	1	1	1	1	1	1	1	1	1	1	1	1	1	1	1	1	1	1	1	1	1	1	1	1	1	1		
10nF	103	1	1	1	1	1	1	1	1	1	1	1	1	1	1	1	1	1	1	1	1	1	1	1	1	1	1	1	1	1	1		
12	123	1	1	1	1	1	1	1	1	1	1	1	1	1	1	1	1	1	1	1	1	1	1	1	1	1	1	1	1	1	1		
15	153	1	1	1	1	1	1	1	1	1	1	1	1	1	1	1	1	1	1	1	1	1	1	1	1	1	1	1	1	1	1		
18	183	1	1	1	1	1	1	1	1	1	1	1	1	1	1	1	1	1	1	1	1	1	1	1	1	1	1	1	1	1	1		
22	223	1	1	1	1	1	1	1	1	1	1	1	1	1	1	1	1	1	1	1	1	1	1	1	1	1	1	1	1	1	1		
27	273	1	1	1	1	1	1	1	1	1	1	1	1	1	1	1	1	1	1	1	1	1	1	1	1	1	1	1	1	1	1		
33	333	1	1	1	1	1	1	1	1	1	1	1	1	1	1	1	1	1	1	1	1	1	1	1	1	1	1	1	1	1	1		
39	393	1	1	1	1	1	1	1	1	1	1	1	1	1	1	1	1	1	1	1	1	1	1	1	1	1	1	1	1	1	1		
47	473	1	1	1	1	1	1	1	1	1	1	1	1	1	1	1	1	1	1	1	1	1	1	1	1	1	1	1	1	1	1		
56	563	1	1	1	1	1	1	1	1	1	1	1	1	1	1	1	1	1	1	1	1	1	1	1	1	1	1	1	1	1	1		
68	683	1	1	1	1	1	1	1	1	1	1	1	1	1	1	1	1	1	1	1	1	1	1	1	1	1	1	1	1	1	1		
82	823	1	1	1	1	1	1	1	2	1	1	1	1	1	1	1	1	1	1	1	1	1	1	1	1	1	1	1	1	1	1		
100nF	104	1	1	1	1	1	1	1	2	1	1	1	1	1	1	1	1	1	1	1	1	1	1	1	1	1	1	1	1	1	1		
120	124	1	1	1	1	1	1	2	2	1	1	1	1	1	1	1	1	1	1	1	1	1	1	1	1	1	1	1	1	1	1		
150	154	1	1	1	1	1	1	2	3	1	1	1	1	1	1	1	2	1	1	1	1	1	1	1	1	1	1	1	1	1	1		
180	184	1	1	1	1	1	1	2	3	1	1	1	1	1	1	2	1	1	1	1	1	1	1	1	1	1	1	1	1	1	1		
220	224	1	1	1	1	1	1	3	4	1	1	1	1	1	1	2	1	1	1	1	1	1	2	1	1	1	1	1	1	1	1		
270	274	1	1	1	1	1	1	3	5	1	1	1	1	1	2	3	1	1	1	1	1	1	2	1	1	1	1	1	1	1	1		
330	334	1	1	1	1	1	1	4		1	1	1	1	1	2	3	1	1	1	1	1	1	2	1	1	1	1	1	1	1	1		
390	394	1	1	1	1	1	1	4		1	1	1	1	1	2	4	1	1	1	1	1	1	2	3	1	1	1	1	1	1	1		
470	474	1	1	1	1	1	1	5		1	1	1	1	1	3	4	1	1	1	1	1	1	2	3	1	1	1	1	1	1	2		
560	564	1	1	1	1	2	2			1	1	1	1	1	3	5	1	1	1	1	1	1	2	4	1	1	1	1	1	1	2	2	
680	684	1	1	2	2	2	3			1	1	1	1	1	2	4	1	1	1	1	1	3	4	1	1	1	1	1	1	1	2	2	
820	824	2	2	2	2	2	3			1	1	1	1	1	2	4	1	1	1	1	1	3	5	1	1	1	1	1	1	1	2	3	
1.0µF	105	2	2	2	2	3	3			1	1	1	1	2	2	5	1	1	1	1	1	2	4	1	1	1	1	1	1	1	2	3	
1.2	125	2	2	2	2	3	4			1	1	1	2	2	3		1	1	1	1	2	2	4		1	1	1	1	1	1	3	3	
1.5	155	2	3	3	3	4	5			2	2	2	2	2	3		1	1	1	1	2	2	5		1	1	1	1	1	1	3	4	
1.8	185	3	3	3	3	4				2	2	2	2	3	4		1	2	2	2	2	3		1	1	1	1	1	2	4	5		
2.2	225	3	3	4	4	5				2	2	2	3	3	4		2	2	2	2	2	3		1	1	1	1	2	2	2	5		
2.7	275	4	4	4	5					2	3	3	3	4	5		2	2	2	2	3	4		1	1	1	2	2	2				
3.3	335	5	5	5						3	3	3	4	4			2	2	3	3	3	4		1	1	2	2	2	3				
3.9	395	5								3	3	4	4	5			3	3	3	3	4	5		1	1	2	2	3	3				
4.7	475									4	4	4	5				3	3	4	4	5			2	2	2	2	3	3				
5.6	565									4	5	5					4	4	4	4				2	2	2	3	3	4				
6.8	685									5							4	4	5	5				2	2	3	3	4	5				
8.2	825																5	5						2	2	3	4	5					
10µF	106																							3	3	4	4						
12	126																							3	3	4	5						
15	156																							4	4	5							
18	186																							4	5								
22	226																							5									
27	276																																
33	336																																
39	396																																
47	476																																
56	566																																
68	686																																
82	826																																
100µF	107																																

Number of chips required to achieve the capacitance value



# Capacitor Assemblies - 'Cap-Rack' Arrays



The 'Cap-Rack' (US Patent 6,058,004) is an assembly of individual chip capacitors, bonded with high temperature epoxy. A 'Cap-Rack' can be made up of a pair, to as many as eight same size chips - 0603, 0805, 1005, 1206, 1210, 1808, 1812, 1825, 2221 and 2225 - into one single component providing extended freedom for PCB space utilization. Footprint dimensions can also vary to further optimize board space usage. The patented design allows the chips to behave as individual components, not as a single large ceramic mass, and therefore reduces harmful thermal stress during assembly. Typical applications are in Multi-line designs, Mobile phones, Automotive, Computers, Network Devices and Medical products.

Electrical advantages include reduction in "cross talk", to insignificant levels, by elimination of capacitance coupling between adjacent capacitors; the ability to combine resistors and inductors within the 'Cap-Rack', as well as mixing and matching capacitance values and dielectrics.

Mechanical advantages include reduced board area; easier to handle; reduced placement cost; reduces component stress and decreased cycle time. 'Cap-Rack' can also be used with traditional pick and place equipment.

Consult the sales office for High Reliability versions and custom designs, particularly for high voltage applications.

- For dielectric characteristics see pages 2 to 4.
- For dimensions of individual chips see page 20.
- P and AW dimensions are dependant on the chips utilized in the array.
- Cap Arrays require drawings to specify length and width of array and chip size used. Please contact the Sales Office.

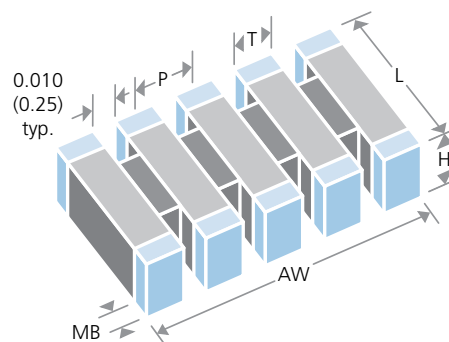

## Dimensions - inches/mm

Size	0603	0805	1005	1206	1210	1808	1812	1825	2221	2225
Max number of Caps	6	6	6	6	6	6	8	8	8	8

## Ordering information - 'Cap-Rack' Arrays

CR	1206	N	562	K	101	N	H	T	- 4
Style	Size	Dielectric	Capacitance in picofarads (pF)	Capacitance tolerance	Voltage d.c.	Termination	Hi-Rel Option	Packing	No. of chips
Cap-Rack	Size of individual chips that make up the array	N = COG/NP0 B = X7R	Value in Picofarads. Two significant figures, followed by number of zeros: 562 = 5600pF	B = 0.10pF* C = 0.25pF* D = 0.50pF* F = ± 1.0%* G = ± 2.0%* H = ± 3.0%* J = ± 5% K = ± 10% M = ± 20% Z = +80% -20% P = +100% -0%  *COG/NP0 only	Two significant figures, followed by number of zeros: 101 = 100V	N = Nickel Barrier (100% tin) P = Palladium Silver Y = Nickel Barrier (90% tin/10% lead)	Ref: MIL-PRF-55681 & MIL-PRF-123	T = Tape & Reel W = Waffle Pack	

# Radial Leaded Capacitors - Ordering Information



## Novacap ordering information - Radial Leaded - Standard and High Rel

0805	B	123	K	501	LE	A	R
Size	Dielectric	Capacitance	Tolerance	Voltage-VDCW	Lead Styles	Packing	RoHS
See charts	<b>N</b> = COG/NPO <b>B</b> = X7R <b>RN</b> = COG/NPO RoHS 2013 ≤ 200V <b>RB</b> = X7R RoHS 2013 ≤ 200V <b>S</b> = X8R not RoHS compliant	Value in Picofarads. Two significant figures, followed by number of zeros: <b>123</b> = 12,000pF	<b>F</b> = ±1%* <b>G</b> = ±2%* <b>J</b> = ±5% <b>K</b> = ±10% <b>M</b> = ±20% *COG parts only	Two significant figures, followed by number of zeros: <b>501</b> = 500V	<b>LE, LB, LD, LR, LO*</b> = Yellow conformal coated <b>LO</b> = without any coating * Product and Case size dependant	No suffix = Bulk <b>A</b> = Ammo pack 2K/pack <b>T</b> = Tape & Reel 4K/Reel	<b>R</b> = RoHS Compliant

## Novacap ordering information - Radial Leaded - High Temperature

2520	E	563	K	501	LG	W	R
Size	Dielectric	Capacitance	Tolerance	Voltage-VDCW	Lead Styles	Packing	RoHS
See charts	<b>D</b> = 200°C COG/NPO <b>E</b> = 200°C Class II	Value in Picofarads. Two significant figures, followed by number of zeros: <b>563</b> = 56,000pF	<b>F</b> = ±1%* <b>G</b> = ±2%* <b>J</b> = ±5% <b>K</b> = ±10% <b>M</b> = ±20% *COG parts only	Two significant figures, followed by number of zeros: <b>501</b> = 500V	<b>LC</b> = Encapsulated <b>LG</b> = Black Epoxy Coated <b>LO</b> = without any coating	No suffix = Bulk <b>W</b> = Waffle pack	<b>R</b> = RoHS Compliant Only available on ≥250V

## Syfer ordering information - Radial Leaded - Standard

8111M	100	0102	J	C	□□□	□□□		
Type No./ Size ref.	Voltage d.c.		Capacitance in picofarads (pF)	Capacitance tolerance	Dielectric Rel Release codes	Suffix code	Suffix code	
	Value	Marking code						
8111M	050 = 50V	(C)	<10pF	<10pF	C = COG/NPO (1B/CG; CG/BP)	Used for specific customer requirements.	C42 denotes RoHS compliant. A31 or A97 denote non-RoHS tin/lead wires.	
8111N	063 = 63V	(D)	Insert a P for the decimal point as the second character. eg. 8P20 = 8.2pF	D: ± 0.5pF				
8121M	100 = 100V	(E)	First digit is 0. Second and third digits are significant figures of capacitance code. Fourth digit is number of zeros eg. 0101 = 100pF	F: ± 1.0pF	X = X7R (2R1)		Suffix A97 for 8111 to 8141 & A31 for 8151, 8161, 8171.	
8121N	200 = 200V	(F)		≥10pF				J: ± 5%
8121T	250 = 250V	-		≥10pF	K: ± 10%			
8131M	500 = 500V	(Q)		≥10pF	M: ± 20%			To Special Order B = 2X1 (BX) R = 2C1 (BZ)
8131T	630 = 630V	-		≥10pF	≥27pF			
8141M	1K0 = 1kV	-		≥10pF	G: ± 2% (COG/NPO only).			
8151M	1K2 = 1.2kV	-		≥10pF				
8161M	1K5 = 1.5kV	-		≥10pF				
8165M	2K0 = 2kV	-		≥10pF				
8171M	2K5 = 2.5kV	-		≥10pF				
	3K0 = 3kV	-		≥10pF				
	4K0 = 4kV	-		≥10pF				
	5K0 = 5kV	-		≥10pF				
	6K0 = 6kV	-		≥10pF				
	8K0 = 8kV	-	≥10pF					
	10K = 10kV	-	≥10pF					
	12K = 12kV	-	≥10pF					

Note: The voltage code may be replaced with the complete voltage (e.g. 1500V = 1K5V) at Syfer's discretion. Marking may be over both sides of the component as necessary.

# Standard Radial Leaded Capacitors - 50V to 5kV

RoHS compliant interconnects, small case size, Radial Leaded capacitors available in COG/NP0, X7R and X8R dielectrics. The conformal coating and lead mounting style provide a rugged configuration for optimum performance. Units exhibit high capacitance efficiency per kV rating and find application in commercial/industrial use up to 5kV, such as power supplies and voltage multiplier circuits. They are offered in bulk pack or taped form, Ref EIA-RS468, making them suitable for automatic insertion.

- For ordering information see page 83.

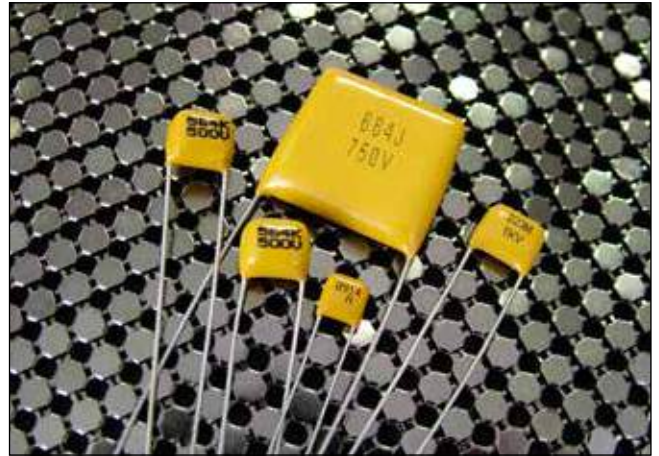

## Dimensions - inches/mm

Lead Style	LE	LD	LR	LD	LQ	LD	LE	LB
Size	0805	0805	1206	1206	1206	1210	1812	2225
Wmax	inches: 0.150 mm: 3.81	0.150 3.81	0.200 5.08	0.200 5.08	0.200 5.08	0.200 5.08	0.300 7.62	0.350 8.89
Hmax	inches: 0.150 mm: 3.81	0.150 3.81	0.150 3.81	0.150 3.81	0.150 3.81	0.200 5.08	0.250 6.35	0.350 8.89
Tmax	inches: 0.100 mm: 2.54	0.100 2.54	0.125 3.18	0.125 3.18	0.125 3.18	0.175 4.45	0.200 5.08	0.200 5.08
HSmax	inches: 0.200 mm: 5.08	0.250 6.35	0.250 6.35	0.250 6.35	0.250 6.35	0.300 7.62	0.350 8.89	0.500 12.70
S	inches $\pm 0.02$ : 0.100 mm $\pm 0.51$ : 2.54	0.200 5.08	0.100 2.54	0.200 5.08	0.250 6.35	0.200 5.08	0.200 5.08	0.200 5.08
WD	inches $\pm 0.02$ : 0.020 mm $\pm 0.51$ : 0.51	0.020 0.51	0.020 0.51	0.020 0.51	0.020 0.51	0.020 0.51	0.025 0.64	0.025 0.64

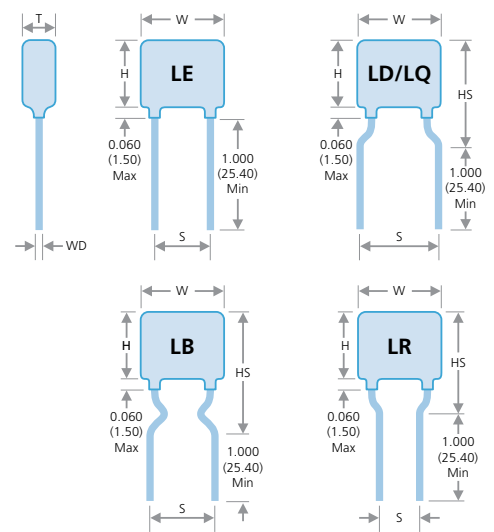

## Capacitance and Voltage Selection - Commercial Radial Leaded Capacitors

Size	0805			1206			1210			1812			2225		
Min cap.	100	121	121	100	121	221	100	121	331	101	151	221	101	471	102
Dielectric	COG	X7R	X8R	COG	X7R	X8R	COG	X7R	X8R	COG	X7R	X8R	COG	X7R	X8R
50V	3.9nF	100nF	47nF	12nF	270nF	150nF	22nF	470nF	270nF	39nF	1.2μF	560nF	120nF	1.8μF	1.2μF
100V	3.9nF	68nF	33nF	10nF	180nF	100nF	18nF	330nF	180nF	27nF	820nF	390nF	82nF	1.5μF	1.0μF
250V	1.5nF	27nF	18nF	3.9nF	68nF	33nF	8.2nF	120nF	82nF	22nF	390nF	150nF	47nF	820nF	560nF
500V	820pF	12nF	5.6nF	1.8nF	22nF	15nF	4.7nF	56nF	39nF	12nF	150nF	56nF	27nF	330nF	150nF
1kV	470pF	2.7nF	•	1.0nF	6.8nF	•	2.2nF	15nF	•	8.2nF	47nF	•	15nF	100nF	•
2kV	•	•	•	390pF	1.0nF	•	820pF	2.2nF	•	2.7nF	6.8nF	•	3.9nF	15nF	•
3kV	•	•	•	•	•	•	•	•	•	1.2nF	2.7nF	•	1.8nF	5.6nF	•
4kV	•	•	•	•	•	•	•	•	•	820pF	1.2nF	•	1.0nF	1.5nF	•
5kV	•	•	•	•	•	•	•	•	•	•	•	•	560pF	1.0nF	•

Notes: 1) Maximum capacitance values are shown above as 3 digit code: 2 significant figures followed by the no. of zeros e.g. 183 = 18,000pF. R denotes decimal e.g. 2R7 = 2.7pF.

2) Parts in this range may be defined as dual-use under export control legislation as such may be subject to export licence restrictions. Please refer to page 12 for more information on the dual-use regulations and contact the Sales Office for further information on specific part numbers.



# Standard Radial Leaded Capacitors - 500V to 10kV

RoHS or Non RoHS Radial Leaded Capacitors available in COG/ NPO and X7R dielectrics with high voltage ratings from 500V. The conformal coating and lead mounting style provide a rugged configuration for optimum performance. Units exhibit high capacitance efficiency per kV rating and find application in commercial/industrial use up to 10kV, such as power supplies and voltage multiplier circuits. They are also offered without the conformal coating for less harsh environmental applications.

● For ordering information see page 83.

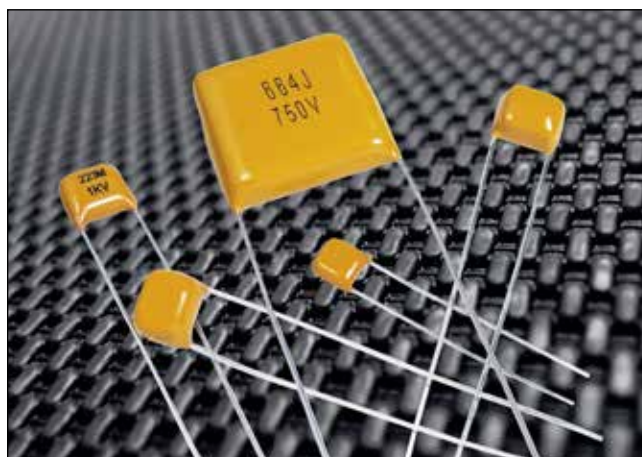

## Dimensions - inches/mm

Lead Style	LE with conformal coating - LO without						
Size	1515	2520	3530	4540	5550	6560	7565
<b>Wmax</b>	inches: 0.250 mm: 6.35	0.400 10.20	0.500 12.70	0.600 15.20	0.700 17.80	0.800 20.30	0.900 22.80
<b>Hmax</b>	inches: 0.250 mm: 6.35	0.350 8.89	0.450 11.40	0.550 14.00	0.650 16.50	0.750 19.00	0.850 21.60
<b>Tmax</b>	inches: 0.200 mm: 5.08	0.250 6.35	0.350 8.89	0.400 10.20	0.400 10.20	0.400 10.20	0.400 10.20
<b>S</b>	inches ±0.02: mm ±0.51:	0.170 4.32	0.280 7.10	0.380 9.65	0.480 12.20	0.580 14.70	0.680 17.30

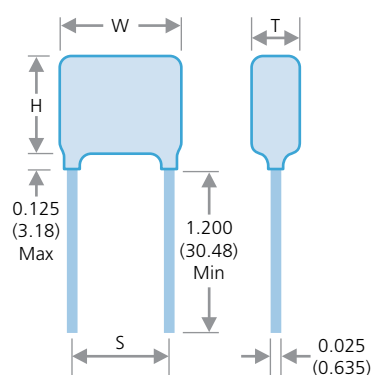

## Capacitance and Voltage Selection - Standard Radial Leaded Capacitors

Size	1515		2520		3530		4540		5550		6560		7565	
Min cap.	100	151	390	102	390	102	390	102	390	102	560	222	101	222
Dielectric	COG	X7R	COG	X7R	COG	X7R	COG	X7R	COG	X7R	COG	X7R	COG	X7R
<b>500V</b>	8.2nF	150nF	39nF	680nF	68nF	1.0µF	120nF	1.8µF	180nF	2.2µF	270nF	3.3µF	330nF	4.7µF
<b>600V</b>	6.8nF	120nF	22nF	390nF	39nF	680nF	82nF	1.5µF	150nF	2.2µF	220nF	2.7µF	270nF	3.9µF
<b>800V</b>	6.8nF	82nF	18nF	270nF	33nF	390nF	68nF	820nF	120nF	1.5µF	180nF	2.2µF	220nF	2.7µF
<b>1kV</b>	5.6nF	56nF	12nF	180nF	27nF	330nF	56nF	680nF	100nF	1.0µF	150nF	1.5µF	180nF	2.2µF
<b>2kV</b>	2.7nF	8.2nF	5.6nF	27nF	15nF	68nF	33nF	180nF	47nF	270nF	68nF	390nF	100nF	470nF
<b>3kV</b>	1.2nF	3.3nF	2.7nF	12nF	10nF	27nF	22nF	68nF	33nF	120nF	47nF	180nF	56nF	220nF
<b>4kV</b>	6.8nF	1.2nF	1.5nF	4.7nF	5.6nF	15nF	12nF	33nF	18nF	47nF	27nF	82nF	39nF	100nF
<b>5kV</b>	•	•	1.0nF	2.7nF	3.3nF	10nF	8.2nF	18nF	12nF	33nF	18nF	47nF	22nF	56nF
<b>6kV</b>	•	•	•	•	1.8nF	5.6nF	3.9nF	12nF	5.6nF	22nF	10nF	33nF	12nF	39nF
<b>7kV</b>	•	•	•	•	1.2nF	4.7nF	2.7nF	8.2nF	4.7nF	15nF	6.8nF	22nF	8.2nF	27nF
<b>8kV</b>	•	•	•	•	1.0nF	3.3nF	2.2nF	6.8nF	3.3nF	12nF	5.6nF	15nF	6.8nF	22nF
<b>9kV</b>	•	•	•	•	•	2.7nF	1.8nF	4.7nF	2.7nF	10nF	3.9nF	12nF	4.7nF	18nF
<b>10kV</b>	•	•	•	•	•	1.8nF	1.5nF	3.9nF	2.2nF	6.8nF	3.3nF	10nF	3.9nF	12nF

Notes: 1) Maximum capacitance values are shown above as 3 digit code: 2 significant figures followed by the no. of zeros e.g. 183 = 18,000pF. R denotes decimal e.g. 2R7 = 2.7pF.

2) Parts in this range may be defined as dual-use under export control legislation as such may be subject to export licence restrictions. Please refer to page 12 for more information on the dual-use regulations and contact the Sales Office for further information on specific part numbers.

# Standard Radial Leaded Capacitors - COG/NP0, X7R

Knowles produces a wide range of dipped radial leaded capacitors. These are available in rated voltages of 50V up to 6kV. Although our catalogue range extends to 6kV, we are able to offer a capability for specials up to 12kV. Our larger case sizes and high voltage versions are particularly in demand, especially for mil/aero and medical power supply applications. Please contact the Sales Office to discuss any special requirements.

- High working voltage - up to 12kVdc
- Large case sizes
- RoHS compliant versions
- Tin-lead plated wire option to reduce tin whiskers (quote suffix A97 for 8111 to 8141 & A31 for 8151, 8161, 8171).
- For ordering information see page 83.



		8111M	8111N	8121M	8121N	8121T	8131M	8131M T = 6.3mm	8131T	8141M	8151M	8151M T = 6.3mm	8161M	8161M T = 7.0mm	8171M	8171M T = 7.0mm
Min. cap values	COG/NP0	4.7pF	4.7pF	4.7pF	4.7pF	4.7pF	4.7pF	-	10pF	4.7pF	10pF	-	27pF	-	47pF	-
	X7R	100pF	100pF	100pF	100pF	330pF	100pF	-	150pF	100pF	470pF	-	1.0nF	-	1.8nF	-
50/63V	COG/NP0	5.6nF	5.6nF	33nF	33nF	33nF	220nF	-	100nF	220nF	330nF	-	680nF	-	1.0µF	-
	X7R	220nF	220nF	1.0µF	1.0µF	1.0µF	3.3µF	-	2.2µF	4.7µF	10µF	-	15µF	-	22µF	-
100V	COG/NP0	2.2nF	2.2nF	18nF	18nF	18nF	82nF	-	47nF	82nF	270nF	-	470nF	-	680nF	-
	X7R	100nF	100nF	680nF	680nF	680nF	2.7µF	-	1.5µF	2.7µF	5.6µF	-	10µF	-	15µF	-
200/ 250V	COG/NP0	1.0nF	1.0nF	8.2nF	8.2nF	8.2nF	47nF	68nF	22nF	47nF	120nF	180nF	270nF	330nF	390nF	560nF
	X7R	56nF	56nF	330nF	330nF	330nF	1.5µF	-	680nF	1.5µF	3.3µF	-	5.6µF	-	10µF	-
500V	COG/NP0	680pF	680pF	6.8nF	6.8nF	6.8nF	33nF	47nF	15nF	33nF	82nF	120nF	180nF	270nF	270nF	470nF
	X7R	15nF	15nF	150nF	150nF	150nF	820nF	-	330nF	820nF	1.0µF	-	1.8µF	-	3.3µF	-
630V	COG/NP0	560pF	560pF	3.9nF	3.9nF	3.9nF	22nF	39nF	10nF	22nF	68nF	100nF	120nF	180nF	220nF	390nF
	X7R	12nF	12nF	100nF	100nF	100nF	390nF	-	180nF	470nF	680nF	-	1.2µF	-	2.2µF	-
1kV	COG/NP0	180pF	180pF	2.2nF	2.2nF	2.2nF	18nF	27nF	6.8nF	18nF	47nF	82nF	82nF	150nF	150nF	270nF
	X7R	10nF	10nF	47nF	47nF	47nF	150nF	-	100nF	150nF	180nF	-	390nF	-	1.0µF	-
1.2kV	COG/NP0	120pF	120pF	1.5nF	1.5nF	1.5nF	12nF	22nF	4.7nF	12nF	33nF	56nF	68nF	100nF	100nF	180nF
	X7R	-	-	10nF	10nF	10nF	100nF	-	33nF	100nF	150nF	-	220nF	-	470nF	-
1.5kV	COG/NP0	82pF	82pF	820pF	820pF	820pF	6.8nF	12nF	2.7nF	6.8nF	22nF	39nF	39nF	68nF	68nF	120nF
	X7R	-	-	6.8nF	6.8nF	6.8nF	68nF	-	22nF	68nF	100nF	-	150nF	-	330nF	-
2kV	COG/NP0	39pF	39pF	390pF	390pF	390pF	4.7nF	6.8nF	1.5nF	4.7nF	10nF	18nF	22nF	39nF	39nF	68nF
	X7R	-	-	4.7nF	4.7nF	4.7nF	33nF	-	10nF	47nF	47nF	-	82nF	-	150nF	-
2.5kV	COG/NP0	-	-	220pF	220pF	220pF	2.2nF	3.9nF	820pF	2.2nF	6.8nF	12nF	12nF	22nF	22nF	39nF
	X7R	-	-	-	-	-	12nF	-	3.3nF	12nF	33nF	-	68nF	-	100nF	-
3kV	COG/NP0	-	-	150pF	150pF	150pF	1.8nF	2.7nF	560pF	1.8nF	4.7nF	8.2nF	10nF	18nF	15nF	27nF
	X7R	-	-	-	-	-	8.2nF	-	2.7nF	10nF	22nF	-	47nF	-	82nF	-
4kV	COG/NP0	-	-	-	-	-	820pF	1.5nF	270pF	820pF	1.8nF	3.3nF	4.7nF	6.8nF	8.2nF	15nF
	X7R	-	-	-	-	-	5.6nF	-	2.2nF	5.6nF	6.8nF	-	15nF	-	33nF	-
5kV	COG/NP0	-	-	-	-	-	560pF	1.0nF	180pF	560pF	1.5nF	2.2nF	2.7nF	4.7nF	5.6nF	10nF
	X7R	-	-	-	-	-	4.7nF	-	1.2nF	4.7nF	5.6nF	-	10nF	-	22nF	-
6kV	COG/NP0	-	-	-	-	-	390pF	680pF	120pF	390pF	1.0nF	1.5nF	1.8nF	3.3nF	3.9nF	6.8nF
	X7R	-	-	-	-	-	2.7nF	-	1.0nF	2.7nF	4.7nF	-	8.2nF	-	15nF	-
8kV	COG/NP0	-	-	-	-	-	-	-	-	-	150pF	-	330pF	-	680pF	-
	X7R	-	-	-	-	-	-	-	-	-	1.5nF	-	4.7nF	-	6.8nF	-
10kV	COG/NP0	-	-	-	-	-	-	-	-	-	100pF	-	180pF	-	470pF	-
	X7R	-	-	-	-	-	-	-	-	-	1.0nF	-	2.2nF	-	4.7nF	-
12kV	COG/NP0	-	-	-	-	-	-	-	-	-	68pF	-	120pF	-	220pF	-
	X7R	-	-	-	-	-	-	-	-	-	820pF	-	1.2nF	-	2.2nF	-
		8111M	8111N	8121M	8121N	8121T	8131M	8131M T = 6.3mm	8131T	8141M	8151M	8151M T = 6.3mm	8161M	8161M T = 7.0mm	8171M	8171M T = 7.0mm

Notes: 1) T = Maximum thickness.  
 2) Parts in this range may be defined as dual-use under export control legislation as such may be subject to export licence restrictions. Please refer to page 12 for more information on the dual-use regulations and contact the Sales Office for further information on specific part numbers.

# Standard Radial Leaded Capacitors - Packaging information

## Dimensions - Radial Leaded capacitors

		Width	Height	Thickness	Lead Space	Lead Diameter
	Pattern	(X) max. mm (inches)	(Y) max. mm (inches)	(Z) max. mm (inches)	(S) mm (inches)	(d) mm (inches)
8111M	A	3.81 (0.15)	5.31 (0.21)	2.54 (0.10)	2.54 ±0.4 (0.1 ±0.016)	0.5 ±0.05 (0.02 ±0.002)
8111N	B	3.81 (0.15)	5.31 (0.21)	2.54 (0.10)	5.08 ±0.4 (0.2 ±0.016)	0.5 ±0.05 (0.02 ±0.002)
8121M	A	5.08 (0.20)	6.58 (0.26)	3.18 (0.125)	2.54 ±0.4 (0.1 ±0.016)	0.5 ±0.05 (0.02 ±0.002)
8121N	B	5.08 (0.20)	6.58 (0.26)	3.18 (0.125)	5.08 ±0.4 (0.2 ±0.016)	0.5 ±0.05 (0.02 ±0.002)
8121T	B	10.16 (0.40)	5.80 (0.23)	4.50 (0.18)	7.62 ±0.4 (0.30 ±0.016)	0.5 ±0.05 (0.02 ±0.002)
8131M	A	7.62 (0.30)	9.12 (0.36)	3.81/6.30 (0.15/0.25)	5.08 ±0.4 (0.2 ±0.016)	0.5 ±0.05 (0.02 ±0.002)
8131T	B	10.16 (0.40)	9.12 (0.36)	4.50 (0.18)	7.62 ±0.4 (0.30 ±0.016)	0.5 ±0.05 (0.02 ±0.002)
8141M	A	10.16 (0.40)	11.66 (0.46)	3.81 (0.15)	5.08 ±0.4 (0.2 ±0.016)	0.5 ±0.05 (0.02 ±0.002)
8151M	A	12.70 (0.50)	14.20 (0.56)	5.08/6.30 (0.20/0.25)	10.1 ±0.4 (0.4 ±0.016)	0.6 ±0.05 (0.025 ±0.002)
8161M	A	18.50 (0.73)	16.50 (0.65)	6.00/7.00 (0.24/0.28)	14.5 ±0.5 (0.57 ±0.02)	0.6 ±0.05 (0.025 ±0.002)
8165M	A	19.00 (0.75)	19.00 (0.75)	4.25 (0.17)	17.5 ±0.5 (0.67 ±0.02)	0.6 ±0.05 (0.025 ±0.002)
8171M	A	25.00 (0.98)	20.00 (0.79)	6.00/7.00 (0.24/0.28)	21.0 ±0.6 (0.83 ±0.024)	0.6 ±0.05 (0.025 ±0.002)

Pattern A

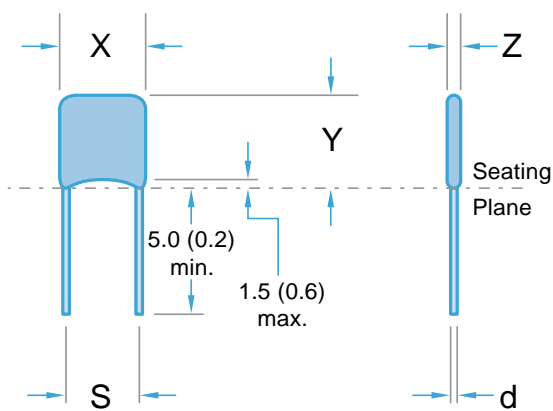

Pattern B

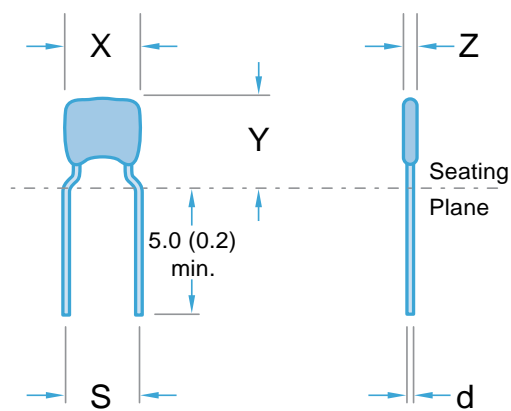

Note: Pattern A may be substituted with Pattern B at Knowles' discretion.

## Marking information

All encapsulated capacitors are marked with: Capacitance value, tolerance, rated d.c. voltage, dielectric and, where size permits, the Syfer 'S' logo.

Example: 1000pF ±10% 50V 2X1 dielectric

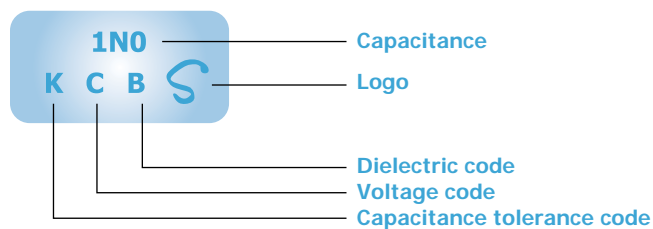

Note: Parts in this range may be defined as dual-use under export control legislation as such may be subject to export licence restrictions. Please refer to page 12 for more information on the dual-use regulations and contact the Sales Office for further information on specific part numbers.

# Radial Leded Capacitors - Packaging information

## Cropped leads

Cropped leads between 4.0 (0.157) and 30.0 (1.18) are available to special order. Some of the preferred codes are listed below, together with the appropriate suffix code.

Dimensions as for standard product except as specified.

Suffix code - AE3 All radial ranges	Suffix code - AE4 All radial ranges	Suffix code - AD7 All radial ranges	Suffix code - AD5 All radial ranges
Lead length (L) 6 ± 1 (0.236 ± 0.04) from seating plane	Lead length (L) 4 ± 1 (0.162 ± 0.04) from seating plane	Lead length (L) 5 ± 1 (0.2 ± 0.04) from seating plane	Lead length (L) 10 ± 1 (0.4 ± 0.04) from seating plane

Dimensions mm (inches)

## Snap in leads

Various forms of snap in leads (preformed) are available to special order, some of the preferred suffix codes are listed below.

Dimensions as for standard product except as specified.

### Suffix code - AD1

For PCB holes 0.9mm diameter  
Types 8121N and 8131M

Dimensions

Y = 8121N 8 (0.315) Max  
8131M 10 (0.394) Max  
L = Min: 2.75 (0.108)  
Max: 3.50 (0.138)

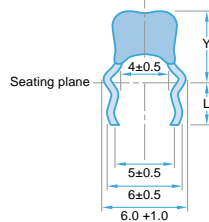

### Suffix code - AD2

For PCB holes 1.2mm diameter  
Types 8131M

Dimensions

Y = 10 (0.294) Max  
L = Min: 2.75 (0.108)  
Max: 3.50 (0.138)

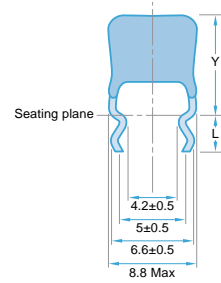

### Suffix code - AD3

For PCB holes 1.2mm diameter  
Types 8121N

Dimensions

Y = 8 (0.315) Max  
L = Min: 2.75 (0.108)  
Max: 3.50 (0.138)

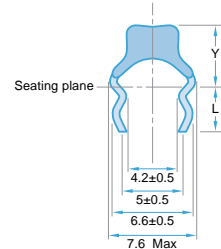

## Bandoliered suffix codes

Dipped radial leded with 2.54 and 5.08mm lead spacing can be supplied bandoliered on reels or in ammo boxes to special order. Some of the preferred suffix codes for bandoliered products are given below.

For bandoliered products the minimum order quantity, pieces, is specified in the tables below, larger orders must be in multiples of this quantity.

## Dipped – straight and formed leads

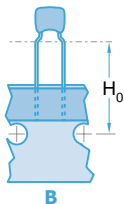
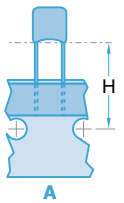

Product code	Lead style	Diagram	H	H <sub>0</sub>	Suffix code		
					Reel 2500pcs	AMMO pack	
					1000pcs	2000pcs	
8111M	Straight 2.54 crs	A	19±1	–	C01	C02	C11
8111M	Straight 2.54 crs	A	16±0.5	–	C30	C31	C32
8111N	Formed 5.08 crs	B	–	16±0.5	C01	C02	C11
8121M	Straight 2.54 crs	A	19±1	–	C01	C02	C11
8121M	Straight 2.54 crs	A	16±0.5	–	C30	C31	C32
8121N	Formed 5.08 crs	B	–	16±0.5	C01	C02	C11
8131M	Straight 5.08 crs	A	19±1	–	C01	C02	C11
8131M	Straight 5.08 crs	A	16±0.5	–	C30	C31	C32

Note: 8121T and 8131T available in bulk packaging only.

## Dipped – stand-off lead form



This style has been developed to provide a meniscus-free seating plane with a stress relieving form for auto-insertion.

Product code	Lead style	Y max	H <sub>0</sub>	2500pcs	1000pcs	2000pcs
8111N	Formed 5.08 crs	7.5	16±0.5	C12	C23	C22
8111N	Formed 5.08 crs	7.5	19±1	C13	C25	C24
8121N	Formed 5.08 crs	8.5	16±0.5	C12	C23	C22
8121N	Formed 5.08 crs	8.5	19±1	C13	C25	C24

# Radial Leaded Capacitors - Packaging information

For automatic insertion, the number of empty places in the tape per reel or fan-fold arrangement shall not exceed:

Three (3) missing components, when the component pitch is equivalent to one sprocket hole pitch.

One (1) missing component, when the component pitch is equivalent to two sprocket hole pitches or more.

At the beginning and end of a reel the bandolier will exhibit at least 10 blank positions.

Minimum pull strength of product from tape = 5N.

Each reel/carton is provided with a label showing the: Manufacturer, product style, batch identification, quantity and date code.

Labelling with bar codes (code 39) is available on request.

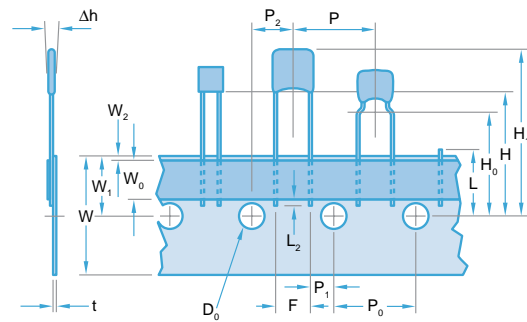

In accordance with IEC 60286 part 2.

## Dimensions mm (inches)

Description	Symbol	2.5mm lead space	5mm lead space	Tolerance
Lead wire diameter	d	0.5 (0.02) 0.6 (0.025)	0.5 (0.02) 0.6 (0.025)	±0.05 (0.002)
Component pitch	P	12.7 (0.5)	12.7 (0.5)	1.00 (0.04)
Feed hole pitch	P <sub>0</sub>	12.7 (0.5)	12.7 (0.5)	±0.30 (0.01)
Feed hole centre to lead	P <sub>1</sub>	5.08 (0.2)	3.81 (0.15)	±0.70 (0.03)
Feed hole centre to component	P <sub>2</sub>	6.35 (0.25)	6.35 (0.25)	±0.70 (0.03)
Lead spacing	F	2.54 (0.10)	5.08 (0.20)	+0.6 (0.02) -0.1 (0.004)
Component alignment	Δh	0	0	±2.00(0.08)
Tape width	W	18.0 (0.70)	18.0 (0.70)	+1.00 (0.04) -0.50 (0.02)
Hold down tape width	W <sub>0</sub>	6.0 (0.23)	6.0 (0.23)	±0.30 (0.01)
Hole position	W <sub>1</sub>	9.0 (0.35)	9.0 (0.35)	±0.50 (0.02)
Hold down tape position	W <sub>2</sub>	0.50 (0.02)	0.50 (0.02)	Max
Height to seating plane from tape centre (straight leads) (2)	H	16 (0.63) to 20 (0.79)	16 (0.63) to 20 (0.79)	As required
Height to seating plane from tape centre (formed leads) (2)	H <sub>0</sub>	16 (0.63) to 20 (0.79)	16 (0.63) to 20 (0.79)	As required
Height to top of component from tape centre	H <sub>1</sub>	32.2 (1.26)	32.2 (1.26)	Max
Feed hole diameter	D <sub>0</sub>	4.0 (0.16)	4.0 (0.16)	±0.20 (0.008)
Carrier tape plus adhesive tape thickness	t	0.7 (0.03)	0.7 (0.03)	±0.20 (0.008)
Carrier tape thickness	-	0.5 (0.02)	0.5 (0.02)	±0.10 (0.004)
Cut out component snipped lead length from tape centre	L	11.0 (0.43)	11.0 (0.43)	Max
Lead wire protrusion from hold down	L <sub>2</sub>	2.0 (0.08)	2.0 (0.08)	Max

## Bandoliered reels

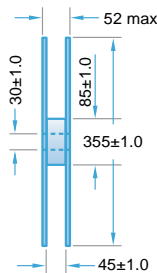
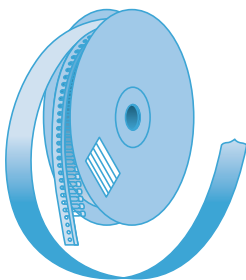

The adhesive tape faces outwards. The dispensing direction is as shown. For the protection of the components a paper inlay is inserted between the windings of the bandolier. At the end of the bandolier this paper inlay continues for at least a further two rotations.

## Bandoliered ammo packing

2 carton sizes

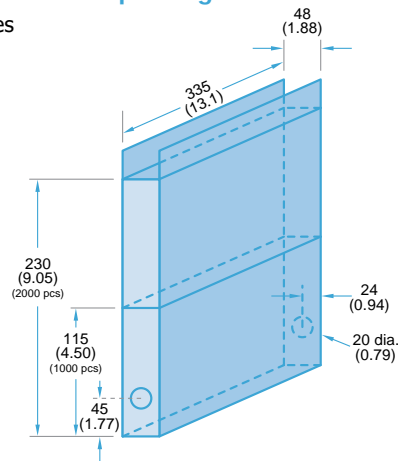

# High Temp Radial Leded Caps - Epoxy Coated

A range of Radial Leded capacitors available in sizes 1515 to 7565 designed to operate from -55°C to 200°C in COG/NP0 and Class II dielectrics with voltage ratings of 25V to 4kV. These capacitors find typical application in harsh environments such as Oil Exploration and Automotive/Avionics engine compartment circuitry. The epoxy coating ensures environmental protection and a rugged configuration for optimum performance. They are also offered without the conformal coating for less harsh environmental applications.

- Capacitance tolerances:  $\pm 1\%^*$ ,  $\pm 2\%^*$ ,  $\pm 5\%$ ,  $\pm 10\%$ ,  $\pm 20\%$  (\*COG/NP0 only)
- For ordering information see page 83.



## Dimensions - inches/mm

Lead Style		LG with black epoxy coating - LO without						
Size		1515	1812	2520	3530	4540	6560	7565
<b>W</b>	inches:	0.250	0.300	0.370	0.470	0.570	0.770	0.870
	mm:	6.35	7.62	9.40	11.90	14.50	19.60	22.10
<b>H</b>	inches:	0.250	0.200	0.300	0.400	0.500	0.720	0.770
	mm:	6.35	5.08	7.62	10.20	12.70	18.30	19.60
<b>T</b>	inches:	0.190	0.160	0.240	0.310	0.360	0.360	0.360
	mm:	4.83	4.06	6.10	7.87	9.14	9.14	9.14
<b>S</b>	inches $\pm 0.02$ :	0.170	0.200	0.280	0.380	0.480	0.680	0.780
	mm $\pm 0.508$ :	4.32	5.08	7.10	9.65	12.20	17.30	19.80

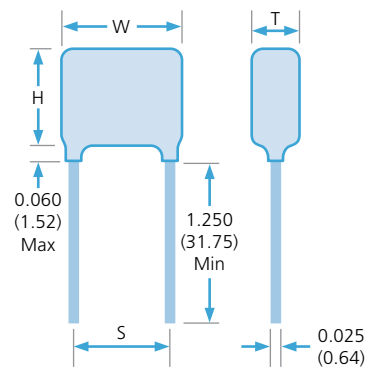

## Maximum capacitance values - 200°C COG/NP0 (D)/Class II (E) dielectrics

Size	1515		1812		2520		3530		4540		6560		7565	
Min cap.	5R0	151	220	151	390	102	390	102	390	102	560	222	101	222
Dielectric	COG	Class II	COG	Class II	COG	Class II	COG	Class II	COG	Class II	COG	Class II	COG	Class II
<b>25V</b>	22nF	820nF	27nF	1.0 $\mu$ F	56nF	2.2 $\mu$ F	100nF	3.9 $\mu$ F	180nF	5.6 $\mu$ F	330nF	15 $\mu$ F	390nF	18 $\mu$ F
<b>50V</b>	18nF	680nF	22nF	650nF	56nF	1.8 $\mu$ F	82nF	2.7 $\mu$ F	150nF	4.7 $\mu$ F	270nF	12 $\mu$ F	330nF	15 $\mu$ F
<b>100V</b>	10nF	270nF	10nF	270nF	33nF	1.2 $\mu$ F	56nF	2.2 $\mu$ F	100nF	3.3 $\mu$ F	220nF	8.2 $\mu$ F	270nF	12 $\mu$ F
<b>250V</b>	3.9nF	82nF	6.8nF	100nF	15nF	270nF	33nF	560nF	56nF	1.2 $\mu$ F	120nF	2.7 $\mu$ F	150nF	3.9 $\mu$ F
<b>500V</b>	2.7nF	18nF	3.3nF	22nF	5.6nF	56nF	12nF	120nF	27nF	330nF	56nF	680nF	68nF	820nF
<b>1kV</b>	820pF	2.7nF	1.0nF	3.3nF	1.8nF	12nF	5.6nF	27nF	15nF	68nF	33nF	150nF	39nF	220nF
<b>2kV</b>	180pF	560pF	220pF	680pF	390pF	2.2nF	1.5nF	6.8nF	3.3nF	18nF	8.2nF	39nF	10nF	47nF
<b>3kV</b>	8.2pF	220pF	100pF	220pF	180pF	820pF	560pF	2.7nF	1.5nF	6.8nF	3.3nF	15nF	3.9nF	18nF
<b>4kV</b>	4.7pF	•	•	•	100pF	220pF	330pF	1.2nF	820pF	2.7nF	1.8nF	5.6nF	2.2nF	8.2nF

Note: Maximum capacitance values are shown above as 3 digit code: 2 significant figures followed by the no. of zeros e.g. 183 = 18,000pF. R denotes decimal e.g. 2R7 = 2.7pF.

# High Temp Radial Leaded Caps - Encapsulated

A range of Radial Leaded capacitors available in sizes 1515 to 7565 designed to operate from -55°C to 200°C in COG/NP0 and Class II dielectrics. Voltage ratings of 25V to 500V. These capacitors find typical application in very harsh environments where isolation and protection of the device is required for optimum reliability. They are also offered without the molded case for less harsh environmental applications. Consult the Sales Office if your specific requirements exceed our catalogue maximums (size, cap. value and voltage).

- Capacitance tolerances:  $\pm 1\%^*$ ,  $\pm 2\%^*$ ,  $\pm 5\%$ ,  $\pm 10\%$ ,  $\pm 20\%$  (\*COG/NP0 only)
- For ordering information see page 83.

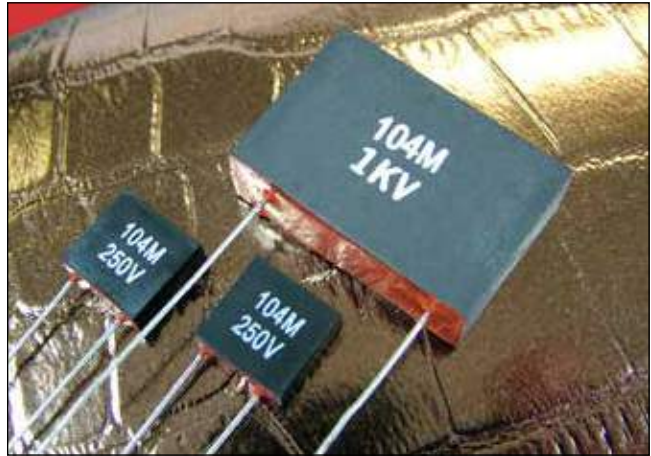

## Dimensions - inches/mm

Lead Style	LC with encapsulation - LO without						
Size	1515	2520	3530	4540	5550	6560	7565
<b>W</b> inches $\pm 0.015$ : mm $\pm 0.381$ :	0.300 7.62	0.400 10.20	0.500 12.70	0.725 18.40	0.795 20.20	0.925 23.50	1.125 28.60
<b>H</b> inches $\pm 0.015$ : mm $\pm 0.51$ :	0.300 7.62	0.400 10.20	0.500 12.70	0.500 12.70	0.745 18.90	0.750 19.00	0.750 19.00
<b>T</b> inches $\pm 0.015$ : mm $\pm 0.51$ :	0.150 3.81	0.200 5.08	0.265 6.73	0.325 8.26	0.370 9.40	0.350 8.89	0.375 9.52
<b>S</b> inches $\pm 0.02$ : mm $\pm 0.508$ :	0.170 4.32	0.280 7.10	0.380 9.65	0.480 12.20	0.580 14.70	0.680 17.30	0.780 19.80

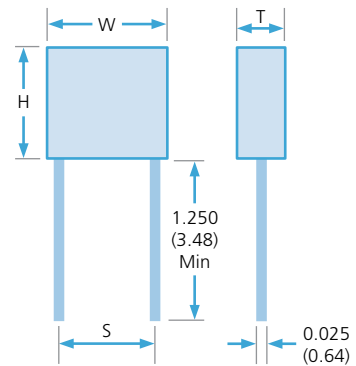

## Maximum capacitance values - 200°C COG/NP0 (D)/Class II (E) dielectrics

Size	1515		2520		3530		4540		5550		6560		7565	
Min cap.	3R0	221	390	102	390	102	390	102	390	102	560	222	101	222
Dielectric	COG	Class II	COG	Class II	COG	Class II	COG	Class II	COG	Class II	COG	Class II	COG	Class II
<b>25V</b>	18nF	560nF	56nF	2.2 $\mu$ F	100nF	3.9 $\mu$ F	180nF	5.6 $\mu$ F	220nF	10 $\mu$ F	330nF	15 $\mu$ F	390nF	18 $\mu$ F
<b>50V</b>	15nF	390nF	56nF	1.5 $\mu$ F	82nF	2.7 $\mu$ F	150nF	4.7 $\mu$ F	180nF	6.8 $\mu$ F	270nF	12 $\mu$ F	330nF	15 $\mu$ F
<b>100V</b>	5.6nF	120nF	27nF	820nF	56nF	1.8 $\mu$ F	100nF	3.3 $\mu$ F	150nF	5.6 $\mu$ F	220nF	8.2 $\mu$ F	270nF	10 $\mu$ F
<b>250V</b>	3.9nF	39nF	12nF	180nF	273	560nF	56nF	1.2 $\mu$ F	82nF	2.2 $\mu$ F	120nF	2.7 $\mu$ F	150nF	3.9 $\mu$ F
<b>500V</b>	1.5nF	8.2nF	5.6nF	39nF	12nF	82nF	27nF	220nF	39nF	330nF	56nF	470nF	82nF	680nF

Note: Maximum capacitance values are shown above as 3 digit code: 2 significant figures followed by the no. of zeros e.g. 183 = 18,000pF. R denotes decimal e.g. 2R7 = 2.7pF.

# Surface Mount EMI Filters - E01 & E07 feedthrough capacitors

The Syfer E01 and E07 ranges of feedthrough MLCC chip 'C' filters are 3 terminal chip devices designed to offer reduced inductance compared to conventional MLCCs when used in signal line filtering. The filtered signal passes through the chip internal electrodes and the noise is filtered to the grounded side contacts, resulting in reduced length noise transmission paths.

Available in COG/NPO and X7R dielectrics, with current ratings of 300mA, 1A, 2A, 3A and voltage ratings of 25Vdc to 200Vdc. Also available with FlexiCap™ termination which is strongly recommended for new designs.

Commonly used in automotive applications, a range qualified to AEC-Q200 is also available.

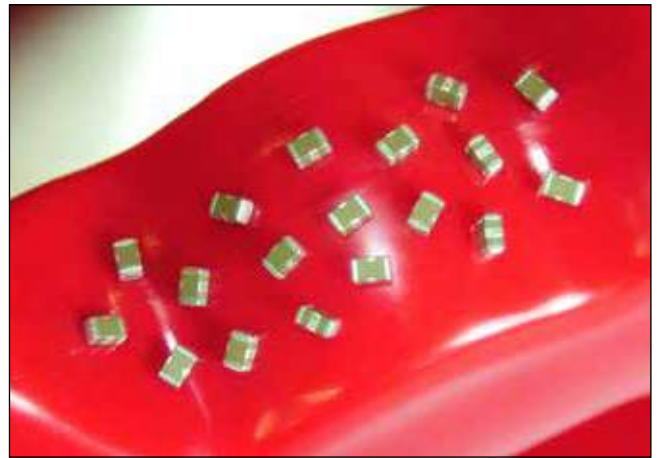

## E01 300mA, E07 1A/2A/3A

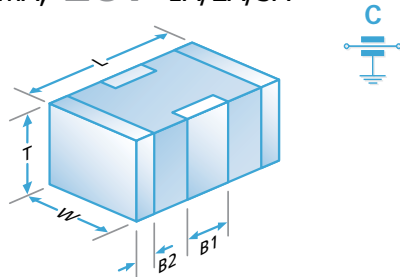

### Dimensions

	0805	1206	1806	1812
L	2.0 ± 0.3 (0.079 ± 0.012)	3.2 ± 0.3 (0.126 ± 0.012)	4.5 ± 0.35 (0.177 ± 0.014)	4.5 ± 0.35 (0.177 ± 0.014)
W	1.25 ± 0.2 (0.049 ± 0.008)	1.6 ± 0.2 (0.063 ± 0.008)	1.6 ± 0.2 (0.063 ± 0.008)	3.2 ± 0.3 (0.126 ± 0.012)
T	1.0 ± 0.15 (0.039 ± 0.006)	1.1 ± 0.2 (0.043 ± 0.008)	1.1 ± 0.2 (0.043 ± 0.008)	2.0 ± 0.3 (0.079 ± 0.012)
B1	0.60 ± 0.2 (0.024 ± 0.008)	0.95 ± 0.3 (0.037 ± 0.012)	1.4 ± 0.3 (0.055 ± 0.012)	1.45 ± 0.35 (0.055 ± 0.012)
B2	0.3 ± 0.15 (0.012 ± 0.006)	0.5 ± 0.25 (0.02 ± 0.01)	0.5 ± 0.25 (0.02 ± 0.01)	0.75 ± 0.25 (0.02 ± 0.01)

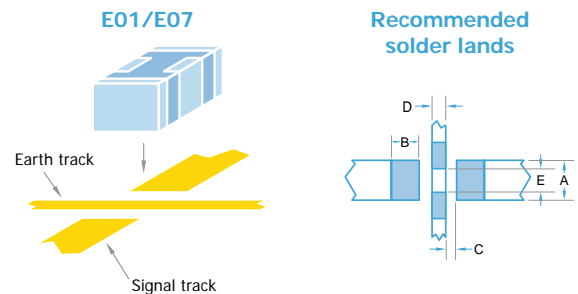

	0805	1206	1806	1812
A	0.95 (0.037)	1.20 (0.047)	1.2 (0.047)	2.65 (0.104)
B	0.90 (0.035)	0.90 (0.035)	1.40 (0.055)	1.40 (0.055)
C	0.30 (0.012)	0.60 (0.024)	0.80 (0.031)	0.80 (0.031)
D	0.40 (0.016)	0.80 (0.031)	1.40 (0.055)	1.40 (0.055)
E	0.75 (0.030)	1.0 (0.039)	1.0 (0.039)	2.05 (0.080)

- Notes: 1) All dimensions mm (inches).  
 2) Pad widths less than chip width gives improved mechanical performance.  
 3) The solder stencil should place 4 discrete solder pads. The unprinted distance between ground pads is shown as dim E.  
 4) Insulating the earth track underneath the filters is acceptable and can help avoid displacement of filter during soldering but can result in residue entrapment under the chip.

## Standard Range - E01 & E07 Feedthrough Capacitors

Type		E01			E07			
Chip Size		0805	1206	1806	0805	1206	1806	1812
Max Current		300mA	300mA	300mA	1A	2A	2A	3A
Rated Voltage	Dielectric	Minimum and maximum capacitance values						
25Vdc	COG/NPO	180pF-1.5nF	560pF-3.9nF	820pF-4.7nF	180pF-1.5nF	560pF-3.9nF	820pF-4.7nF	-
	X7R	470pF-100nF	5.6nF-330nF	3.9nF-560nF	820pF-100nF	10nF-330nF	22nF-560nF	560nF-1.8µF
50Vdc	COG/NPO	22pF-820pF	22pF-3.3nF	22pF-3.9nF	10pF-220pF	22pF-1nF	100pF-1.5nF	-
	X7R	560pF-68nF	4.7nF-220nF	3.3nF-330nF	1nF-68nF	10nF-220nF	22nF-330nF	330nF-1.5µF
100Vdc	COG/NPO	22pF-560pF	22pF-2.2nF	22pF-3.3nF	10pF-120pF	22pF-560pF	100pF-680pF	-
	X7R	560pF-27nF	1.8nF-100nF	3.3nF-180nF	1nF-27nF	10nF-100nF	22nF-180nF	180nF-820nF
200Vdc	COG/NPO	-	560pF-1.2nF	56pF-1nF	-	15pF-180pF	56pF-470pF	-
	X7R	-	2.7nF-56nF	3.9nF-100nF	-	12nF-56nF	22nF-100nF	100nF-270nF

Note: E07 25Vdc COG/NPO 1206 and 1806 ranges in green, have maximum current of 1A.

## AEC-Q200 Qualified Range - E01 & E07 Feedthrough Capacitors - maximum capacitance values

Type		E01			E07		
Chip Size		0805	1206	1806	0805	1206	1806
50V	COG/NPO	820pF	1nF	2.2nF	220pF	1nF	1.5nF
	X7R	47nF	100nF	200nF	47nF	100nF	200nF
100V	COG/NPO	560pF	1nF	2.2nF	120pF	560pF	680pF
	X7R	15nF	15nF	68nF	15nF	15nF	68nF

Notes: ■ = AEC-Q200. For some lower capacitance parts, higher voltage rated parts may be supplied.



# Surface Mount EMI Filters - E01 & E07 feedthrough capacitors

## Open board insertion loss performance in 50Ω system

Open Board Performance						
Capacitance	0.1MHz	1MHz	10MHz	100MHz	1GHz	Resonance Freq (MHz) approx.
10pF	0	0	0	0	7.5	2200
22pF	0	0	0	0	16	1600
33pF	0	0	0	1	22	1350
47pF	0	0	0	2	28	1150
68pF	0	0	0	3	41	900
100pF	0	0	0	5	28	800
150pF	0	0	0	8	24	700
220pF	0	0	0	12	20	600
330pF	0	0	1	15	20	500
470pF	0	0	2	18	20	425
560pF	0	0	3	20	20	350
680pF	0	0	4	22	20	300
820pF	0	0	5	24	20	260
1.0nF	0	0	7	27	20	220
1.5nF	0	0	9	31	20	200
2.2nF	0	0	12	34	20	170
3.3nF	0	1	14	39	20	135
4.7nF	0	2	18	46	20	110
6.8nF	0	3	21	50	20	90
10nF	0	5	24	48	20	80
15nF	0	8	27	45	20	65
22nF	0	12	31	43	20	56
33nF	1	14	34	40	20	40
47nF	2	17	38	40	20	34
68nF	4	20	41	40	20	30
100nF	6	24	45	40	20	28
150nF	8	26	48	40	20	24
220nF	10	30	52	40	20	17
330nF	13	33	55	40	20	15.5
470nF	16	36	60	40	20	14
560nF	18	39	65	40	20	12

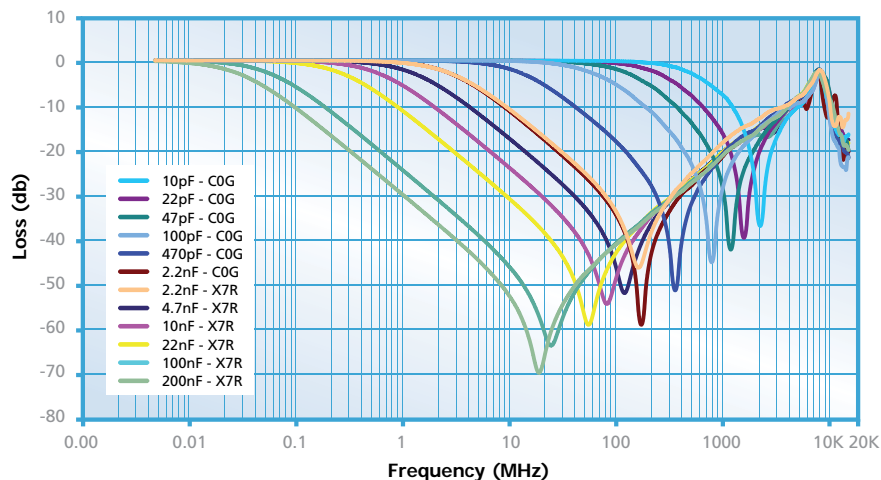

## Ordering Information - E01 & E07 feedthrough capacitors

1206	Y	100	0103	M	X	T	E07
Chip size	Termination	Voltage	Capacitance in picofarads (pF)	Tolerance	Dielectric	Packaging	Type
0805 1206 1806 1812	J = Nickel Barrier (Tin) *Y = FlexiCap™ (Tin - X7R only) A = (Tin/Lead) Not RoHS compliant. *H = FlexiCap™ (Tin/Lead) Not RoHS compliant.	025 = 25V 050 = 50V 100 = 100V 200 = 200V	First digit is 0. Second and third digits are significant figures of capacitance code. The fourth digit is number of zeros following Example: 0103 = 10000pF.	M = ±20%	A = C0G/NP0 AEC-Q200 C = C0G/NP0 E = X7R AEC-Q200 X = X7R	T = 178mm (7") reel R = 330mm (13") reel B = Bulk	E01 E07

Note: \*FlexiCap™ termination only available in X7R material. Please contact our Sales Office for any special requirements.

### Reeled quantities

178mm (7") reel	0805	1206	1806	1812	330mm (13") reel	0805	1206	1806	1812
	3000	2500	2500	1000		12000	10000	10000	4000

# Surface Mount EMI Filters - E03 X2Y Integrated Passive Components

The Syfer X2Y Integrated Passive Component is a 3 terminal EMI chip device.

When used in balanced line applications, the revolutionary design provides simultaneous line-to-line and line-to-ground filtering, using a single ceramic chip. In this way, differential and common mode filtering are provided in one device.

For unbalanced applications, it provides ultra low ESL (equivalent series inductance). Capable of replacing 2 or more conventional devices, it is ideal for balanced and unbalanced lines, twisted pairs and dc motors, in automotive, audio, sensor and other applications.

Available in sizes from 0805 to 1812, these filters can prove invaluable in meeting stringent EMC demands.

Manufactured by Knowles Capacitors under licence from X2Y Attenuators LLC.



**Dielectric**  
X7R or COG/NPO

**Electrical configuration**  
Multiple capacitance

**Capacitance measurement**  
At 1000hr point

**Typical capacitance matching**  
Better than 5%  
(down to 1% available on request)

**Temperature rating**  
-55°C to 125°C

**Insulation resistance**  
100Gohms or 1000s (whichever is the less)

**Dielectric withstand voltage**  
≤200V 2.5 times rated Volts for 5 secs  
500V 1.5 times rated Volts for 5 secs  
Charging current limited to 50mA Max.

Type		E03			
Chip size		0805	1206	1410	1812
Rated voltage	Dielectric				
25Vdc	COG/NPO	560pF - 820pF	1.8nF - 3.3nF	6.8nF - 8.2nF	12nF - 15nF
	X7R	56nF - 68nF	-	470nF	820nF
50Vdc	COG/NPO	390pF - 470pF	1.2nF - 1.5nF	4.7nF - 5.6nF	8.2nF - 10nF
	X7R	18nF - 47nF	56nF - 220nF	180nF - 400nF	390nF - 680nF
100Vdc	COG/NPO	10pF - 330pF	22pF - 1.0nF	100pF - 3.9nF	820pF - 6.8nF
	X7R	470pF - 15nF	1.5nF - 47nF	4.7nF - 150nF	8.2nF - 330nF
200Vdc	COG/NPO	-	22pF - 1.0nF	100pF - 3.3nF	820pF - 5.6nF
	X7R	-	820pF - 33nF	1.2nF - 120nF	2.7nF - 180nF
500Vdc	COG/NPO	-	-	-	820pF - 3.9nF
	X7R	-	-	-	2.7nF - 100nF

Note: For some lower capacitance parts, higher voltage rated parts may be supplied.

## AEC-Q200 range (E03) - capacitance values

Chip size		0805	1206	1410	1812
50Vdc	COG/NPO	390pF - 470pF	1.2nF - 1.5nF	4.7nF - 5.6nF	8.2nF - 10nF
	X7R	18nF - 33nF	56nF - 150nF	180nF - 330nF	390nF - 560nF
100Vdc	COG/NPO	10pF - 330pF	22pF - 1.0nF	100pF - 3.9nF	820pF - 6.8nF
	X7R	470pF - 15nF	1.5nF - 47nF	4.7nF - 150nF	8.2nF - 330nF

Note: ■ = AEC-Q200.

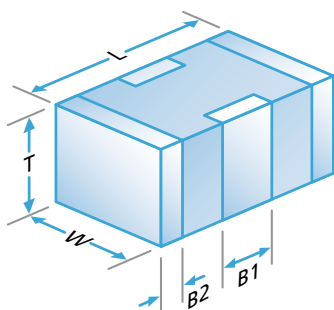

	0805	1206	1410	1812
L	2.0±0.3 (0.08±0.012)	3.2±0.3 (0.126±0.012)	3.6±0.3 (0.14±0.012)	4.5±0.35 (0.18±0.014)
W	1.25±0.2 (0.05±0.008)	1.60±0.2 (0.063±0.008)	2.5±0.3 (0.1±0.012)	3.2±0.3 (0.126±0.012)
T	1.0±0.15 (0.04±0.006)	1.1±0.2 (0.043±0.008)	2.0 max. (0.08 max.)	2.1 max. (0.08 max.)
B1	0.5±0.25 (0.02±0.01)	0.95±0.3 (0.037±0.012)	1.20±0.3 (0.047±0.012)	1.4±0.35 (0.06±0.014)
B2	0.3±0.15 (0.012±0.006)	0.5±0.25 (0.02±0.01)	0.5±0.25 (0.02±0.01)	0.75±0.25 (0.03±0.01)

- Notes:
- 1) All dimensions mm (inches).
  - 2) Pad widths less than chip width gives improved mechanical performance.
  - 3) The solder stencil should place 4 discrete solder pads. The un-printed distance between ground pads is shown as dim E.
  - 4) Insulating the earth track underneath the filters is acceptable and can help avoid displacement of filter during soldering but can result in residue entrapment under the chip.

# Surface Mount EMI Filters - E03 X2Y Integrated Passive Components

## Recommended solder lands

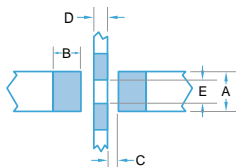

	0805	1206	1410	1812
A	0.95 (0.037)	1.2 (0.047)	2.05 (0.08)	2.65 (0.104)
B	0.9 (0.035)	0.9 (0.035)	1.0 (0.040)	1.4 (0.055)
C	0.3 (0.012)	0.6 (0.024)	0.7 (0.028)	0.8 (0.031)
D	0.4 (0.016)	0.8 (0.031)	0.9 (0.035)	1.4 (0.055)
E	0.75 (0.030)	1.0 (0.039)	1.85 (0.071)	2.05 (0.080)

Component	Advantages	Disadvantages	Applications
<b>Chip capacitor</b>	Industry standard	Requires 1 per line High inductance Capacitance matching problems	By-pass Low frequency
<b>3 terminal feedthrough</b>	Feedthrough Lower inductance	Current limited	Feedthrough Unbalanced lines High frequency
<b>Syfer X2Y Integrated Passive Component</b>	Very low inductance Replaces 2 (or 3) components Negates the effects of temperature, voltage and ageing Provides both common mode and differential mode attenuation Can be used on balanced & unbalanced lines	Care must be taken to optimise circuit design	By-pass Balanced lines High frequency dc electric motors Unbalanced lines Audio amplifiers CANBUS

## Filtering application

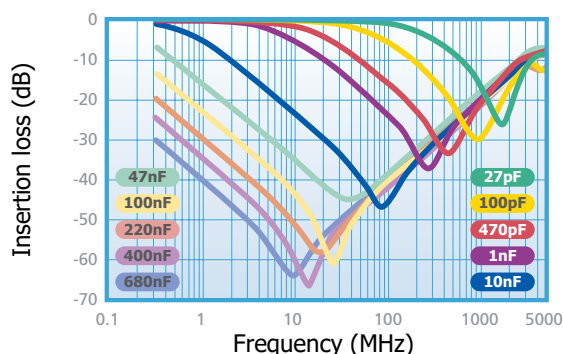
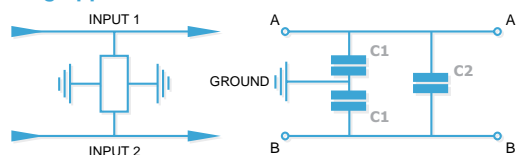

## Decoupling application

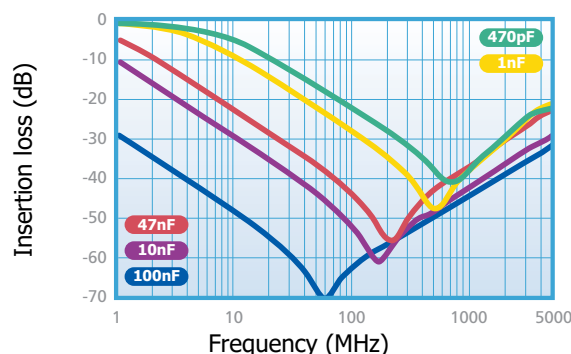
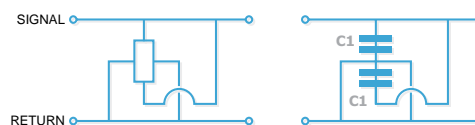

## Ordering Information - X2Y IPC range

1812	Y	100	0334	M	X	T	E03
Chip Size	Termination	Voltage	Capacitance in picofarads (pF) C <sub>1</sub>	Tolerance	Dielectric	Packaging	Type
0805 1206 1410 1812	J = Nickel Barrier (Tin) *Y = FlexiCap™ (Tin - X7R only) A = (Tin/Lead) Not RoHS compliant. *H = FlexiCap™ (Tin/Lead) Not RoHS compliant.	025 = 25V 050 = 50V 100 = 100V 200 = 200V 500 = 500V	First digit is 0. Second and third digits are significant figures of capacitance code. The fourth digit is number of zeros following Example: 0334=330nF. Note: C <sub>1</sub> = 2C <sub>2</sub>	M = ±20% (Tighter tolerances may be available on request).	A = COG/NP0 AEC-Q200 C = COG/NP0 E = X7R AEC-Q200 X = X7R	T = 178mm (7") reel R = 330mm (13") reel B = Bulk	Syfer X2Y Integrated Passive Component

Note: \*FlexiCap™ termination only available in X7R material. Please contact the sales office for any special requirements.

## Reeled quantities

178mm (7") reel	0805	1206	1410	1812	330mm (13") reel	0805	1206	1410	1812
	3000	2500	2000	1000		12000	10000	8000	4000



Trimmers



Pulse Capacitors



Special Discrete Filters



Half-turn Trimmers

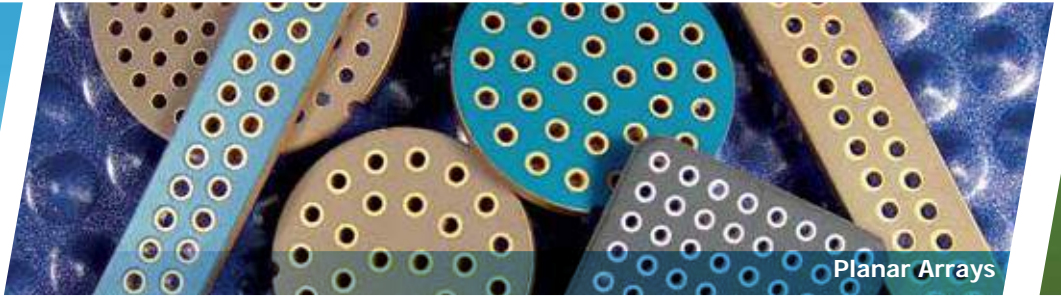

Planar Arrays



Single Layer Capacitors



Feedthrough EMI Filters



Gain Equalizers



Specialty Products

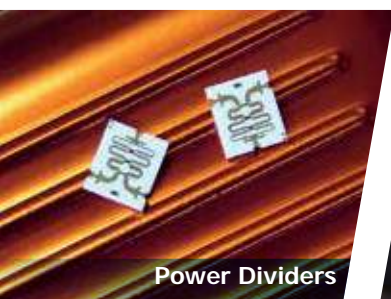

Power Dividers



Varistor Filters



Trimmer Ca

***Other products available***



Hi-Rel Products



Hi-Rel and Specialty Products



Thin Film Devices



Trimmer Capacitors



Special Filters

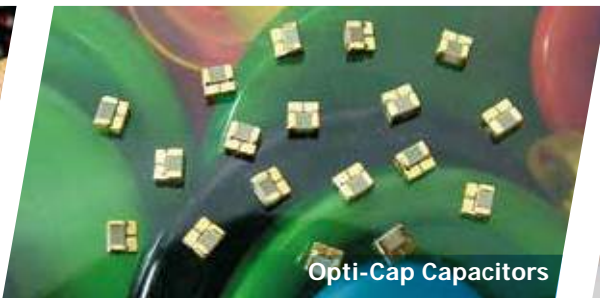

Opti-Cap Capacitors



Hi-Cap Capacitors

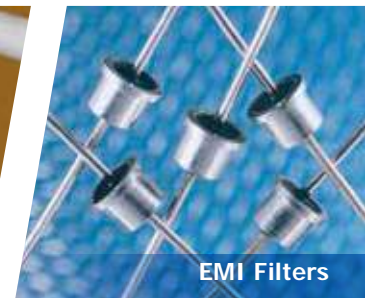

EMI Filters

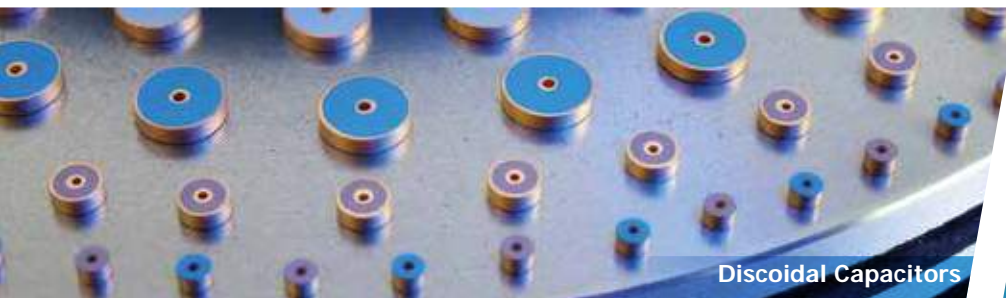

Discoidal Capacitors



Thin Film Devices



capacitors



Varistor Arrays

*from*



**knowles**

DLI•JohansonMFG•Novacap•Syfer•Voltronics



# knowles

DLI•JohansonMFG•Novacap•Syfer•Voltronics

Knowles Capacitors designs, manufactures and sells special electronic components. Our products are used in military, space, telecom infrastructure, medical and industrial applications where function and reliability are crucial.



Knowles (Cazenovia)  
2777 Route 20 East, Cazenovia,  
NY 13035 USA  
Phone: +1 315 655 8710  
Fax: +1 315 655 0445  
KCCSales@knowles.com



Knowles (Cazenovia)  
2777 Route 20 East, Cazenovia,  
NY 13035 USA  
Phone: +1 315 655 8710  
Fax: +1 315 655 0445  
KCCSales@knowles.com



Knowles (Valencia)  
25111 Anza Drive, Valencia,  
CA 91355 USA  
Phone: +1 661 295 5920  
Fax: +1 661 295 5928  
NovacapSales@knowles.com



Knowles (UK) Ltd  
Hethel Engineering Centre, Chapman Way,  
Hethel, Norwich, Norfolk NR14 8FB  
Phone: +44 1603 723300  
Fax: +44 1603 723301  
SyferSales@knowles.com



Knowles (Cazenovia)  
2777 Route 20 East, Cazenovia,  
NY 13035 USA  
Phone: +1 315 655 8710  
Fax: +1 315 655 0445  
VoltronicsSales@knowles.com

# Mouser Electronics

Authorized Distributor

Click to View Pricing, Inventory, Delivery & Lifecycle Information:

## Knowles:

[1210Y1K00472KXT](#) [0603J2000101JCT](#) [1210J2K00221JCT](#) [1210J1K00100JCT](#) [1210J2K00100JCT](#)  
[1210J2K00101JCT](#) [1210J1K00101JCT](#) [1206J5000151JCT](#) [1206J2000152JCT](#) [1206J5000152JCT](#)  
[1812J5000222JCT](#) [1812J2000103JCT](#) [1812J5000103JCT](#) [1808J1K00103MXT](#) [1206J1000104KXT](#)  
[1210Y0500184KXT](#) [0603J2000100JCT](#) [1206J5000470JCT](#) [1206J5000471JCT](#) [1210J2000331JCT](#)  
[1210J2000332JCT](#) [1812J3K00150JCT](#) [1206Y6300102JCT](#) [1206J5000101KCT](#) [1206J5000101JCT](#)  
[0805J2000681JCT](#) [1206J5000102KCT](#) [1206J5000102JCT](#) [1206J5000220JCT](#) [1206J2000222JCT](#)  
[1206J5000221JCT](#) [1206J0500104MXTE01](#) [1812J3K00470JCT](#) [1812J2K00471JCT](#) [1206J1000102MCTE01](#)  
[1210Y1000333KXT](#) [0805J1000102FCT](#) [1812Y1000474KXT](#) [1210Y5000333KXT](#) [1812Y2000224KXT](#)  
[1812Y5000102KXT](#) [1812Y2000104KXT](#) [1812Y5000104KXT](#) [1812Y5000224KXT](#) [1210Y1K00153KXT](#)  
[0603Y2000152KXT](#) [1210Y5000103KXT](#) [1808Y2K00222KXT](#) [2220Y5000224KXT](#) [1206Y1K00272KXT](#)  
[1812Y3K00681KXT](#) [1210Y5000153KXT](#) [1210Y2000154KXT](#) [0603Y2000681KXT](#) [2220Y1000105KXT](#)  
[1206Y2000222KXT](#) [0805Y2000682KXT](#) [1812Y1K00223KXT](#) [0603Y2000221KXT](#) [1210Y2000124KXT](#)  
[0603Y2000222KXT](#) [1812Y2K00222KXT](#) [1812Y3K00222KXT](#) [1812Y2K00472KXT](#) [1812Y1K00473KXT](#)  
[1210Y5000223KXT](#) [1210Y5000222KXT](#) [0805Y5000471KXT](#) [1812Y3K00102KXT](#) [1812Y2K00102KXT](#)  
[1210Y1K00103KXT](#) [1206Y1K00471KXT](#) [1206Y2000103KXT](#) [1206Y6300103KXT](#) [1206Y5000101KXT](#)  
[1206Y2K00471KXT](#) [1206Y5000103KXT](#) [0603Y2000471KXT](#) [0805Y2000153KXT](#) [0603Y2000472KXT](#)  
[1812Y1K00103KXT](#) [1812Y5000103KXT](#) [1206Y5000152KXT](#) [1812Y0500105KXT](#) [1812Y1000105KXT](#)  
[1206Y5000153KXT](#) [1812Y5000124KXT](#) [1206Y2000683KXT](#) [0603Y2000332KXT](#) [1210Y5000473KXT](#)  
[1812Y5000274KXT](#) [1812Y1K00333KXT](#) [1808Y3K00102KXT](#) [1808Y2K00102KXT](#) [2220Y2K00103KXT](#)  
[0603Y2000101KXT](#) [0603Y2000102KXT](#) [0805Y2000103KXT](#) [0805Y5000101KXT](#) [0805Y2000102KXT](#)