

Micropower 250-mA CMOS LDO Regulator With Error Flag and Power-On-Reset

Check for Samples: [LP3997](#)

FEATURES

- Low 140-mV Dropout at 250-mA Load
- Stable With Ceramic Capacitor.
- Low Noise With Bypass Capacitor
- Less Than 80 μA Typical I_Q at 250 mA
- Virtually Zero I_Q (Disabled)
- Thermal and Short Circuit Protection
- 3.3-V Output ⁽¹⁾
- 8-Lead VSSOP Package ⁽²⁾

APPLICATIONS

- Portable Consumer Electronics
- Cellular Handsets
- Laptop and Palm Computers
- PDAs
- Digital Cameras

- (1) For other voltage options, contact your TI sales office
(2) For other package options, contact your TI sales office.

DESCRIPTION

The LP3997 regulator is designed to meet the requirements of portable, battery-powered systems, providing accurate output voltage, low noise, and low quiescent current. The LP3997 provides 3.3V output at up to 250mA load current. The chip architecture is capable of providing output voltages as low as 0.8V. When switched in shutdown mode, the power consumption is virtually zero.

The LP3997 is designed to be stable with space saving ceramic output capacitor as small as 1 μF .

The LP3997 also includes an out-of-regulation error flag. When the output is more than 5% below its nominal voltage, the error flag sets to low. If a capacitor is connected to device's delay pin, a delayed power-on reset signal will be generated.

Typical Application Circuit

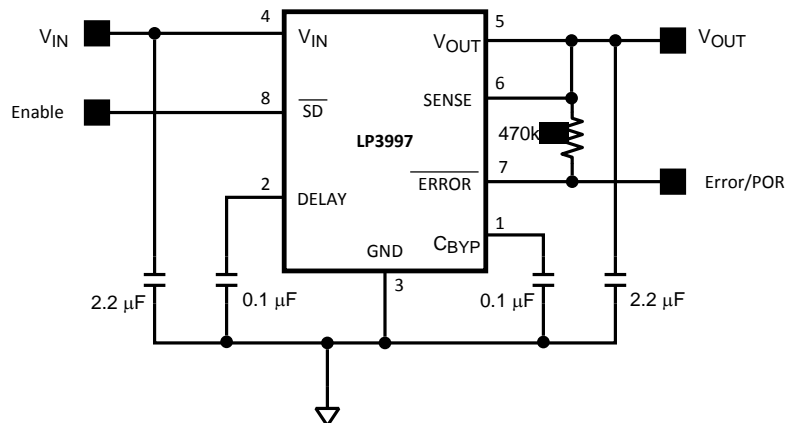

Please be aware that an important notice concerning availability, standard warranty, and use in critical applications of Texas Instruments semiconductor products and disclaimers thereto appears at the end of this data sheet.

All trademarks are the property of their respective owners.

Functional Block Diagram

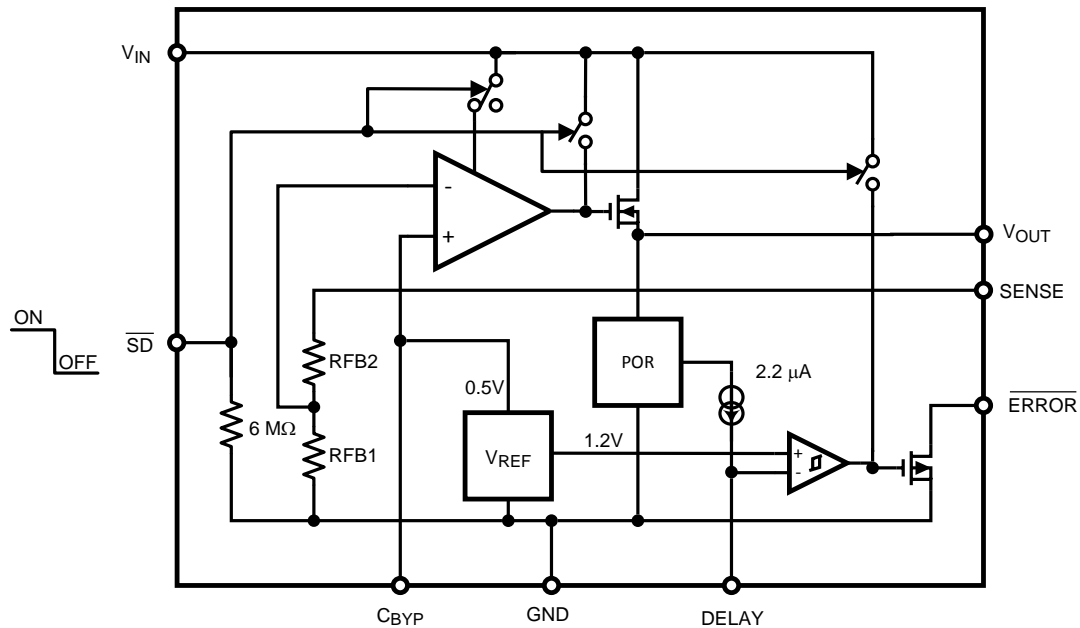

Pin Descriptions

Pin No.	Name	Description
1	CBYP	Noise bypass pin. For low noise applications a 0.1µF or larger ceramic capacitor should be connected from this pin to ground. This will also improve PSSR.
2	DELAY	A capacitor connected from this pin to ground will allow a delayed power-on-reset signal at the ERROR (pin 7) output. See Applications Information .
3	GND	Ground pin. Local ground for CBYP, CIN, COUT and CDELAY.
4	VIN	Input supply pin. Connect CIN between this pin and GND.
5	VOUT	Output voltage, Connect COUT between this pin and ground.
6	SENSE	Connect this pin to VOUT (pin 5). For best performance the connection should be made as close to the load as possible.
7	ERROR	This open drain output is an error flag output which goes low when VOUT drops 5% below its nominal voltage. This pin also provides a power-on-reset signal if a capacitor is connected to the DELAY pin.
8	SD	Shutdown. Disables the regulator when less than 0.4V is applied. Enables the regulator when greater than 0.9V. The Shutdown pin is pulled down internally by a 6MΩ resistor.

Connection Diagram

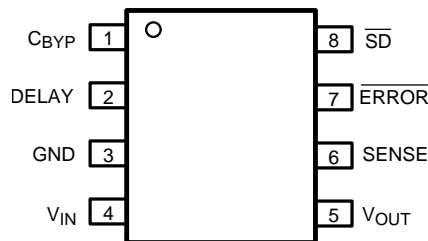

**8-Lead VSSOP
Package Number DGK**



These devices have limited built-in ESD protection. The leads should be shorted together or the device placed in conductive foam during storage or handling to prevent electrostatic damage to the MOS gates.

Absolute Maximum Ratings^{(1) (2)(3)}

Input Voltage			-0.3 to 6.5V
Output Voltage			-0.3 to (V _{IN} + 0.3V) with 6.5V (max)
\overline{SD} Input Voltage			-0.3 to (V _{IN} + 0.3V) with 6.5V (max)
Junction Temperature			150°C
Lead/Pad Temp.			
VSSOP			260°C
Storage Temperature			-65 to 150°C
Continuous Power Dissipation			Internally Limited ⁽⁴⁾
ESD	All Pins Except C _{BYP}	Human Body Model ⁽⁵⁾	2KV
		Machine Model	200V
	C _{BYP} Pin	Human Body Model ⁽⁵⁾	1KV
		Machine Model	100V

- (1) Absolute Maximum Ratings are limits beyond which damage can occur. Operating Ratings are conditions under which operation of the device is ensured. Operating Ratings do not imply ensured performance limits. For ensured performance limits and associated test conditions, see the Electrical Characteristics tables.
- (2) All Voltages are with respect to the potential at the GND pin.
- (3) If Military/Aerospace specified devices are required, please contact the TI Sales Office/Distributors for availability and specifications.
- (4) Internal thermal shutdown circuitry protects the device from permanent damage.
- (5) The human body model is 100pF discharged through a 1.5kΩ resistor into each pin. The machine model is a 200pF capacitor discharged directly into each pin.

Operating Ratings⁽¹⁾

Input Voltage	2V to 6V
Junction Temperature	-40°C to 125°C
Ambient Temperature T _A Range ⁽²⁾	-40°C to 85°C

- (1) Absolute Maximum Ratings are limits beyond which damage can occur. Operating Ratings are conditions under which operation of the device is ensured. Operating Ratings do not imply ensured performance limits. For ensured performance limits and associated test conditions, see the Electrical Characteristics tables.
- (2) The maximum ambient temperature (T_{A(max)}) is dependant on the maximum operating junction temperature (T_{J(max-op)} = 125°C), the maximum power dissipation of the device in the application (P_{D(max)}), and the junction to ambient thermal resistance of the part/package in the application (θ_{JA}), as given by the following equation: T_{A(max)} = T_{J(max-op)} - (θ_{JA} × P_{D(max)}).

Thermal Properties⁽¹⁾

Junction To Ambient Thermal Resistance ⁽²⁾ , θ _{JA} (VSSOP)	210°C/W
---	---------

- (1) Absolute Maximum Ratings are limits beyond which damage can occur. Operating Ratings are conditions under which operation of the device is ensured. Operating Ratings do not imply ensured performance limits. For ensured performance limits and associated test conditions, see the Electrical Characteristics tables.
- (2) Junction to ambient thermal resistance is dependant on the application and board layout. In applications where high maximum power dissipation is possible, special care must be paid to thermal dissipation issues in board design.

Electrical Characteristics

Unless otherwise noted, $\overline{SD} = 950\text{mV}$, $V_{IN} = V_{OUT} + 1.0\text{V}$, $C_{IN} = 2.2\ \mu\text{F}$, $I_{OUT} = 1\ \text{mA}$, $C_{OUT} = 2.2\ \mu\text{F}$ and $C_{BYP} = 0.1\ \mu\text{F}$.

Typical values and limits appearing in normal type apply for $T_J = 27^\circ\text{C}$. Limits appearing in **boldface** type apply over the full temperature range for operation, -40 to $+125^\circ\text{C}$.⁽¹⁾

Symbol	Parameter	Test Conditions	Typ	Limit		Unit
				Min	Max	
V_{IN}	Input Voltage			2	6	V
ΔV_{OUT}	Output Voltage Tolerance	Over full line and load regulation		-1.5	+1.5	%
	Line Regulation Error	$V_{IN} = (V_{OUT(NOM)} + 1.0\text{V})$ to 6.0V , $I_{OUT} = 1\text{mA}$	0.02	-3	+3	%/V
	Load Regulation Error	$I_{OUT} = 1\text{mA}$ to 250mA	20		80	$\mu\text{V}/\text{mA}$
V_{DO}	Dropout Voltage ⁽²⁾	$I_{OUT} = 250\text{mA}$	140		400	mV
I_{LOAD}	Load Current	See ⁽³⁾ ⁽⁴⁾		0		μA
I_Q	Quiescent Current	$\overline{SD} = 950\text{mV}$, $I_{OUT} = 0\text{mA}$	55		100	μA
		$\overline{SD} = 950\text{mV}$, $I_{OUT} = 250\text{mA}$	80		150	
		$\overline{SD} = 0.4\text{V}$	0.01		0.5	
I_{SC}	Short Circuit Current Limit	See ⁽⁵⁾	600		1000	mA
I_{OUT}	Maximum Output Current			250		mA
PSRR	Power Supply Rejection Ratio	$C_{BYP} = 0.1\ \mu\text{F}$	$f = 1\text{kHz}$, $I_{OUT} = 1\text{mA}$ to 150mA	61		dB
			$f = 10\text{kHz}$, $I_{OUT} = 150\text{mA}$	55		
		Without C_{BYP}	$f = 1\text{kHz}$, $I_{OUT} = 1\text{mA}$ to 150mA	61		
			$f = 10\text{kHz}$, $I_{OUT} = 150\text{mA}$	39		
e_n	Output noise Voltage ⁽⁴⁾	BW = 10Hz to 100kHz, $V_{IN} = V_{OUT(nom)} + 1\text{V}$	w/o C_{BYP}	180		μV_{RMS}
			$C_{BYP} = 0.1\ \mu\text{F}$	100		
$T_{SHUTDOWN}$	Thermal Shutdown	Temperature	150			$^\circ\text{C}$
		Hysteresis	10			
Shutdown Control Characteristics						
I_{SD}	Maximum Input Current at \overline{SD} Input	$\overline{SD} = 0.0\text{V}$	0.01			μA
		$\overline{SD} = 6\text{V}$ ⁽⁶⁾	1			
V_{IL}	Low Input Threshold	$V_{IN} = 2\text{V}$ to 6V			0.4	V
V_{IH}	High Input Threshold	$V_{IN} = 2\text{V}$ to 6V		0.95		V
Error Flag Characteristics						
V_{TH}	Power Good Trip Threshold	V_{IN} Rising	95	91	99	$\%V_{OUT}$
V_{HYST}	Hysteresis	V_{IN} Rising or Falling	2.5			$\%V_{OUT}$
V_{OL}	ErrorOutputOutput low Voltage	$I_{SINK} = 2\text{mA}$	0.1		0.4	V
I_{OFF}	Error Output High Leakage	$\overline{ERROR} = V_{OUT(NOM)}$	10		2000	nA
I_{DELAY}	Delay Pin Current Source	$V_{OUT} > 95\% V_{OUT(NOM)}$	2.2	1.2	3	μA

(1) All limits are ensured. All electrical characteristics having room-temperature limits are tested during production at $T_J = 25^\circ\text{C}$ or correlated using Statistical Quality Control methods. Operation over the temperature specification is ensured by correlating the electrical characteristics to process and temperature variations and applying statistical process control.

(2) Dropout voltage is defined as the voltage difference between input and output when the output voltage drops 100mV below its nominal value.

(3) The device maintains the regulated output voltage without the load.

(4) This electrical specification is ensured by design.

(5) Short circuit current is measured on the input supply line at the point when the short circuit condition reduces the output voltage to 5% of its nominal value.

(6) SD Pin has $6\text{M}\Omega$ typical, resistor connected to GND.

Electrical Characteristics (continued)

Unless otherwise noted, $\overline{SD} = 950\text{mV}$, $V_{IN} = V_{OUT} + 1.0\text{V}$, $C_{IN} = 2.2\ \mu\text{F}$, $I_{OUT} = 1\ \text{mA}$, $C_{OUT} = 2.2\ \mu\text{F}$ and $C_{BYP} = 0.1\ \mu\text{F}$.

Typical values and limits appearing in normal type apply for $T_J = 27^\circ\text{C}$. Limits appearing in **boldface** type apply over the full temperature range for operation, -40 to $+125^\circ\text{C}$. ⁽¹⁾

Symbol	Parameter	Test Conditions	Typ	Limit		Unit	
				Min	Max		
Timing Characteristics							
t_{ON}	Turn On Time ⁽⁷⁾	To 95% Level	w/o C_{BYP}	150		250	μs
			$C_{BYP} = 0.1\ \mu\text{F}$	2			ms
Transient Response	Line Transient Response $ \delta V_{OUT} $	$T_{rise} = T_{fall} = 30\ \mu\text{s}$ ⁽⁷⁾ $\delta V_{IN} = 600\text{mV}$	w/o C_{BYP}	40			mV
			$C_{BYP} = 0.1\ \mu\text{F}$	4			(pk - pk)
	Load Transient Response $ \delta V_{OUT} $	$T_{rise} = T_{fall} = 1\ \mu\text{s}$ ⁽⁷⁾ $I_{OUT} = 1\text{mA to }150\text{mA}$		70		80	mV

(7) This electrical specification is ensured by design.

Output Capacitor, Recommended Specifications

Symbol	Parameter	Conditions	Typ	Limit		Unit
				Min	Max	
C_o	Output Capacitor	Capacitance ⁽¹⁾	2.2	0.7		μF
		ESR		5	500	$\text{m}\Omega$

(1) The capacitor tolerance should be 30% or better over temperature. The full operating conditions for the application should be considered when selecting a suitable capacitor to ensure that the minimum value of capacitance is always met. Recommended capacitor type is X7R. However, dependent on application, X5R, Y5V, and Z5U can also be used. (See capacitor characteristics section in [Applications Information](#)).

Typical Performance Characteristics.

Unless otherwise noted, $\overline{SD} = 950\text{mV}$, $V_{IN} = V_{OUT} + 1.0\text{V}$, $C_{IN} = 2.2\ \mu\text{F}$, $I_{OUT} = 1\ \text{mA}$, $C_{OUT} = 2.2\ \mu\text{F}$ and $C_{BYP} = 0.1\ \mu\text{F}$. Typical values and limits appearing in normal type apply for $T_J = 27^\circ\text{C}$. Limits appearing in **boldface** type apply over the full temperature range for operation, -40 to $+125^\circ\text{C}$.

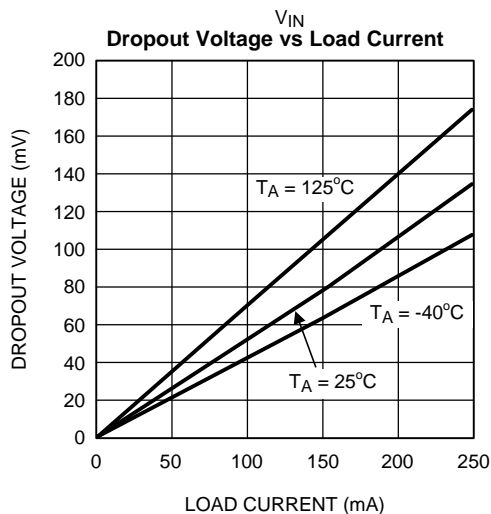
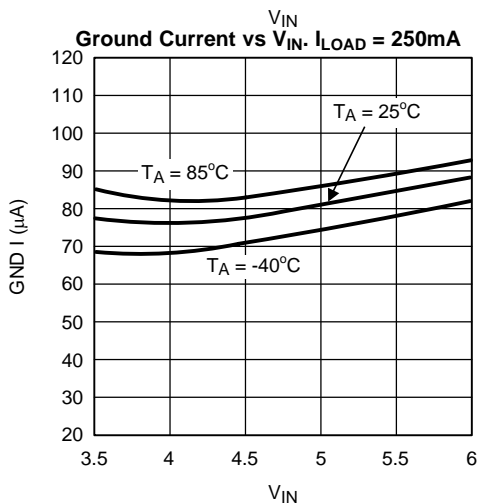
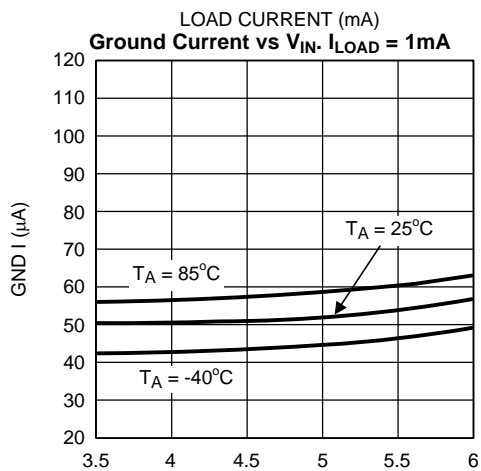
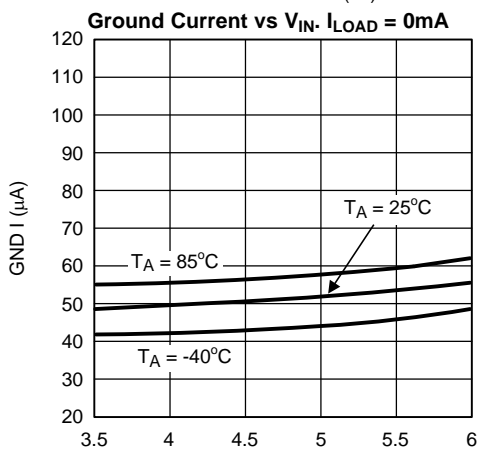
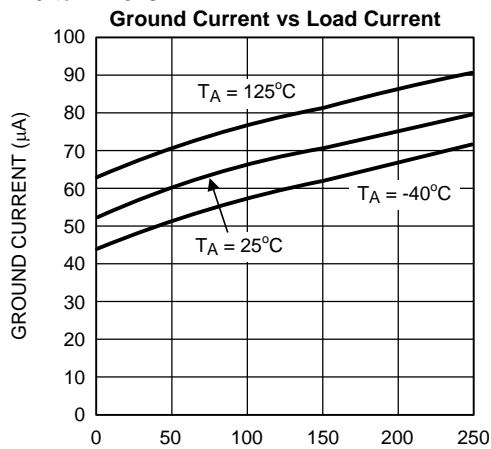
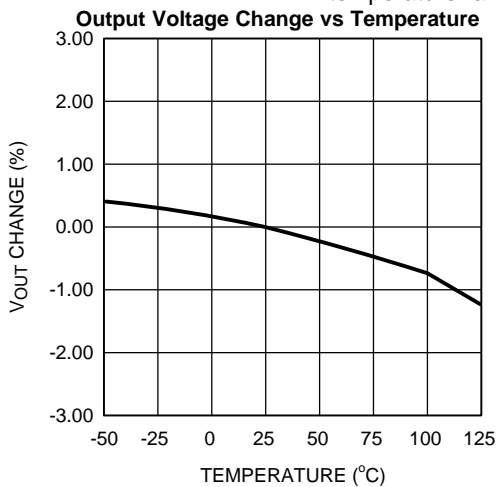

Typical Performance Characteristics. (continued)

Unless otherwise noted, $\overline{SD} = 950\text{mV}$, $V_{IN} = V_{OUT} + 1.0\text{V}$, $C_{IN} = 2.2\ \mu\text{F}$, $I_{OUT} = 1\ \text{mA}$, $C_{OUT} = 2.2\ \mu\text{F}$ and $C_{BYP} = 0.1\ \mu\text{F}$.

Typical values and limits appearing in normal type apply for $T_J = 27^\circ\text{C}$. Limits appearing in **boldface** type apply over the full temperature range for operation, -40 to $+125^\circ\text{C}$.

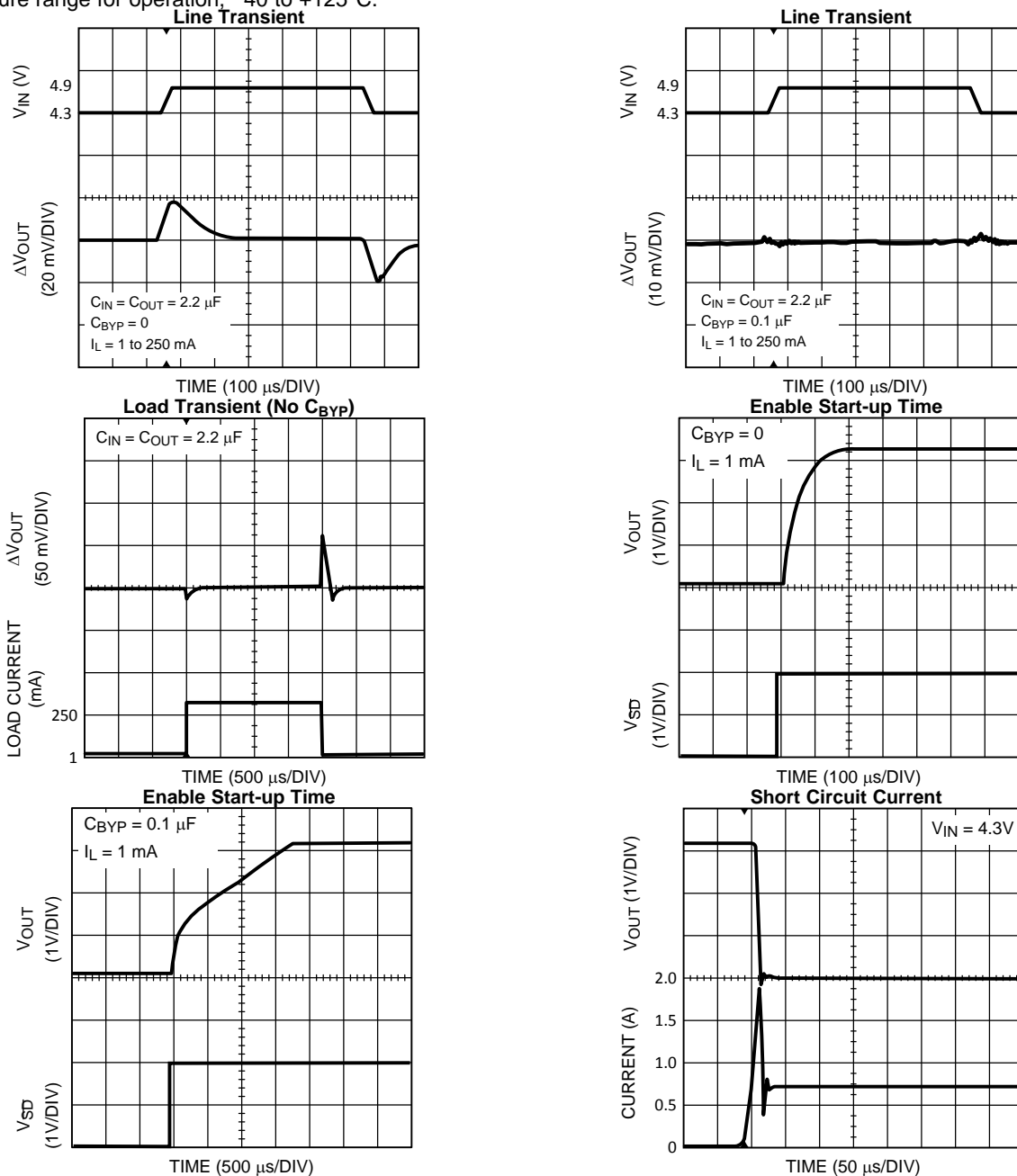

Typical Performance Characteristics. (continued)

Unless otherwise noted, $\overline{SD} = 950\text{mV}$, $V_{IN} = V_{OUT} + 1.0\text{V}$, $C_{IN} = 2.2\ \mu\text{F}$, $I_{OUT} = 1\ \text{mA}$, $C_{OUT} = 2.2\ \mu\text{F}$ and $C_{BYP} = 0.1\ \mu\text{F}$.

Typical values and limits appearing in normal type apply for $T_J = 27^\circ\text{C}$. Limits appearing in **boldface** type apply over the full temperature range for operation, -40 to $+125^\circ\text{C}$.

Power Supply Rejection Ratio

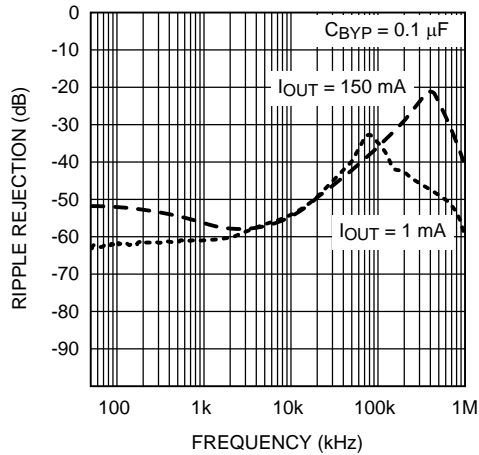

Noise Spectrum

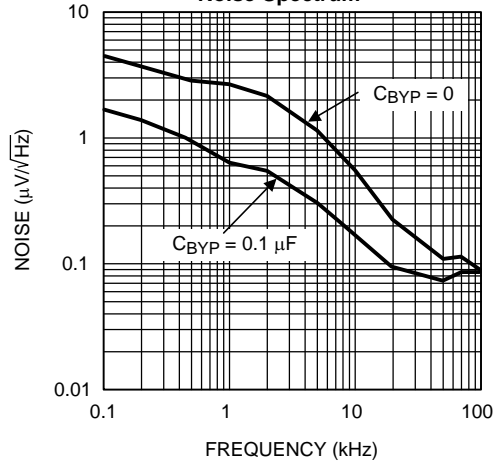

Turn-On Sequence

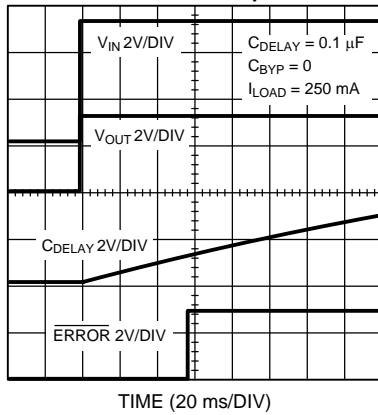

Turn-Off Sequence

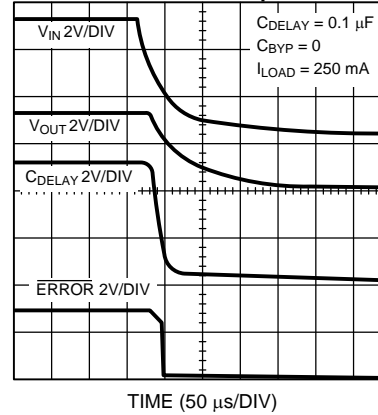

Applications Information

External Capacitors

In common with most regulators, the LP3997 requires the inclusion of external capacitors.

V_{IN}

An input capacitor is required for stability. It is recommended that a minimum of 1.0 μ F capacitor is connected between the LP3997 input pin and ground (this capacitance value may be increased without limit).

This capacitor must be located a distance of not more than 1cm from the input pin and returned to a clean analog ground. Any good quality ceramic, tantalum, or film capacitor may be used at the input.

Important: To ensure stable operation it is essential that good PCB design practices are employed to minimize ground impedance and keep input inductance low. If these conditions cannot be met, or if long wire leads are used to connect the battery or other power source to the LP3997, then it is recommended to increase the input capacitor to at least 2.2 μ F. Also, tantalum capacitors can suffer catastrophic failures due to surge current when connected to a low-impedance source of power (like a battery or a very large capacitor). If a tantalum capacitor is used at the input, it must be ensured by the manufacturer to have a surge current rating sufficient for the application.

There are no requirements for the ESR (Equivalent Series Resistance) on the input capacitor, but tolerance and temperature coefficient must be considered when selecting the capacitor to ensure the capacitance will remain \approx 1.0 μ F over the entire operating temperature range.

V_{OUT}

V_{OUT} is the output voltage of the regulator. Connect capacitance (minimum 1.0 μ F) to ground from this pin. To ensure stability the capacitor must meet the minimum value for capacitance and have an ESR in the range 5m Ω to 500m Ω . Ceramic X7R types are recommended. If an output capacitor larger than 4.7 μ F is fitted then checks on in-rush current, transient performance and stability, should be made.

SENSE

SENSE is used to sense the output voltage. Connect sense to V_{OUT}

SHUTDOWN

\overline{SD} controls the turning on and off of the LP3997. V_{OUT} is ensured to be on when the voltage on the \overline{SD} pin is greater than 0.95V. V_{OUT} is ensured to be off when the voltage on the \overline{SD} pin is less than 0.4V.

\overline{ERROR}

\overline{ERROR} is an open drain output which is set low when V_{OUT} is more than 5% below its nominal value. An external pull up resistor is required on this pin. When a capacitor is connected from DELAY to GROUND, the error signal is delayed (see DELAY section). This delayed error signal can be used as the power-on reset signal for the application system. The \overline{ERROR} pin is disconnected when not used.

DELAY

A capacitor from DELAY to GROUND sets the time delay for \overline{ERROR} changing from low to high state. The delay time is set by the following formula.

$$t_{DELAY} = \frac{V_{TH(DELAY)} \times C_{DELAY}}{I_{DELAY}}$$

$V_{TH(DELAY)}$ is nominally 1.2V.

The DELAY pin should be open circuit if not used.

C_{BYP}

For low noise application, connect a high frequency ceramic capacitor from C_{BYP} to ground, A $0.01\mu\text{F}$ to $0.1\mu\text{F}$ X5R or X7R is recommended. This capacitor is connected directly to high impedance node in the band gap reference circuit. Any significant loading on this node will cause a change in the regulated output voltage. For this reason, DC leakage current from this pin must be kept as low as possible for best output voltage accuracy.

CAPACITOR CHARACTERISTICS

In common with most regulators, the LP3997 requires external capacitors for regulator stability. The LP3997 is specifically designed for portable applications requiring minimum board space and can use capacitors in the range $1\mu\text{F}$ to $4.7\mu\text{F}$. These capacitors must be correctly selected for good performance. Ceramic capacitors are the smallest, least expensive and have the lowest ESR values (which makes them best for eliminating high frequency noise). The ESR of a typical $1\mu\text{F}$ ceramic capacitor is in the range of $20\text{ m}\Omega$ to $40\text{ m}\Omega$, which easily meets the ESR requirement for stability by the LP3997. These capacitors must be correctly selected to ensure good performance of the LP3997.

For both input and output capacitors careful interpretation of the capacitor specification is required to ensure correct device operation. The capacitor value can change greatly dependant on the conditions of operation and capacitor type.

In particular the output capacitor selection should take account of all the capacitor parameters to ensure that the specification is met within the application. Capacitance value can vary with DC bias conditions as well as temperature and frequency of operation. Capacitor values will also show some decrease over time due to aging. The capacitor parameters are also dependant on the particular case size with smaller sizes giving poorer performance figures in general. As an example [Figure 1](#) shows a typical graph showing a comparison of capacitor case sizes in a Capacitance versus DC Bias plot. As shown in the graph, as a result of the DC Bias condition, the capacitance value may drop below the minimum capacitance value given in the recommended capacitor table ($0.7\mu\text{F}$ in this case). Note that the graph shows the capacitance out of spec for the 0402 case size capacitor at higher bias voltages. It is therefore recommended that the capacitor manufacturers' specifications for the nominal value capacitor are consulted for all conditions as some capacitor sizes (e.g. 0402) may not be suitable in the actual application.

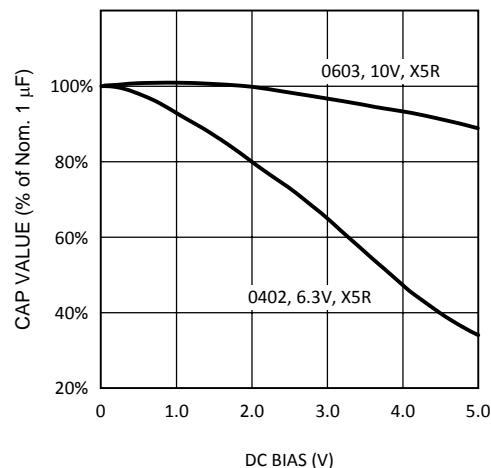

Figure 1. Capacitance versus DC Bias Plot

The value of ceramic capacitors can vary with temperature. The capacitor type X7R, which operates over a temperature range of -55°C to $+125^{\circ}\text{C}$, will only vary the capacitance to within $\pm 15\%$. The capacitor type X5R has a similar tolerance over a reduced temperature range of -55°C to $+85^{\circ}\text{C}$. Most large value ceramic capacitors, larger than $1\mu\text{F}$ are manufactured with Z5U or Y5V temperature characteristics. Their capacitance can drop by more than 50% as the temperature goes from 25°C to 85°C . Therefore X7R is recommended over Z5U and Y5V in applications where the ambient temperature will change significantly above or below 25°C .

Tantalum capacitors are less desirable than ceramic for use as output capacitors because they are more expensive when comparing equivalent capacitance and voltage ratings in the $1\mu\text{F}$ to $4.7\mu\text{F}$ range.

Another important consideration is that tantalum capacitors have higher ESR values than equivalent size ceramics. This means that while it may be possible to find a tantalum capacitor with an ESR value within the stable range, it would have to be larger in capacitance (which means bigger and more costly) than a ceramic capacitor with the same ESR value. It should also be noted that the ESR of a typical tantalum will increase about 2:1 as the temperature goes from 25°C down to -40°C, so some guard band must be allowed.

REVISION HISTORY

Changes from Revision A (May 2013) to Revision B	Page
• Changed layout of National Data Sheet to TI format	11

PACKAGING INFORMATION

Orderable Device	Status (1)	Package Type	Package Drawing	Pins	Package Qty	Eco Plan (2)	Lead/Ball Finish (6)	MSL Peak Temp (3)	Op Temp (°C)	Device Marking (4/5)	Samples
LP3997MM-3.3/NOPB	ACTIVE	VSSOP	DGK	8	1000	Green (RoHS & no Sb/Br)	SN	Level-1-260C-UNLIM	-40 to 125	SAKB	Samples

(1) The marketing status values are defined as follows:

ACTIVE: Product device recommended for new designs.

LIFEBUY: TI has announced that the device will be discontinued, and a lifetime-buy period is in effect.

NRND: Not recommended for new designs. Device is in production to support existing customers, but TI does not recommend using this part in a new design.

PREVIEW: Device has been announced but is not in production. Samples may or may not be available.

OBSOLETE: TI has discontinued the production of the device.

(2) **RoHS:** TI defines "RoHS" to mean semiconductor products that are compliant with the current EU RoHS requirements for all 10 RoHS substances, including the requirement that RoHS substance do not exceed 0.1% by weight in homogeneous materials. Where designed to be soldered at high temperatures, "RoHS" products are suitable for use in specified lead-free processes. TI may reference these types of products as "Pb-Free".

RoHS Exempt: TI defines "RoHS Exempt" to mean products that contain lead but are compliant with EU RoHS pursuant to a specific EU RoHS exemption.

Green: TI defines "Green" to mean the content of Chlorine (Cl) and Bromine (Br) based flame retardants meet JS709B low halogen requirements of <=1000ppm threshold. Antimony trioxide based flame retardants must also meet the <=1000ppm threshold requirement.

(3) MSL, Peak Temp. - The Moisture Sensitivity Level rating according to the JEDEC industry standard classifications, and peak solder temperature.

(4) There may be additional marking, which relates to the logo, the lot trace code information, or the environmental category on the device.

(5) Multiple Device Markings will be inside parentheses. Only one Device Marking contained in parentheses and separated by a "~" will appear on a device. If a line is indented then it is a continuation of the previous line and the two combined represent the entire Device Marking for that device.

(6) Lead/Ball Finish - Orderable Devices may have multiple material finish options. Finish options are separated by a vertical ruled line. Lead/Ball Finish values may wrap to two lines if the finish value exceeds the maximum column width.

Important Information and Disclaimer:The information provided on this page represents TI's knowledge and belief as of the date that it is provided. TI bases its knowledge and belief on information provided by third parties, and makes no representation or warranty as to the accuracy of such information. Efforts are underway to better integrate information from third parties. TI has taken and continues to take reasonable steps to provide representative and accurate information but may not have conducted destructive testing or chemical analysis on incoming materials and chemicals. TI and TI suppliers consider certain information to be proprietary, and thus CAS numbers and other limited information may not be available for release.

In no event shall TI's liability arising out of such information exceed the total purchase price of the TI part(s) at issue in this document sold by TI to Customer on an annual basis.

TAPE AND REEL INFORMATION



QUADRANT ASSIGNMENTS FOR PIN 1 ORIENTATION IN TAPE



*All dimensions are nominal

Device	Package Type	Package Drawing	Pins	SPQ	Reel Diameter (mm)	Reel Width W1 (mm)	A0 (mm)	B0 (mm)	K0 (mm)	P1 (mm)	W (mm)	Pin1 Quadrant
LP3997MM-3.3/NOB	VSSOP	DGK	8	1000	178.0	12.4	5.3	3.4	1.4	8.0	12.0	Q1

TAPE AND REEL BOX DIMENSIONS



*All dimensions are nominal

Device	Package Type	Package Drawing	Pins	SPQ	Length (mm)	Width (mm)	Height (mm)
LP3997MM-3.3/NOPB	VSSOP	DGK	8	1000	210.0	185.0	35.0

DGK (S-PDSO-G8)

PLASTIC SMALL-OUTLINE PACKAGE



- NOTES:
- All linear dimensions are in millimeters.
 - This drawing is subject to change without notice.
 - Body length does not include mold flash, protrusions, or gate burrs. Mold flash, protrusions, or gate burrs shall not exceed 0.15 per end.
 - Body width does not include interlead flash. Interlead flash shall not exceed 0.50 per side.
 - Falls within JEDEC MO-187 variation AA, except interlead flash.



- NOTES:
- A. All linear dimensions are in millimeters.
 - B. This drawing is subject to change without notice.
 - C. Publication IPC-7351 is recommended for alternate designs.
 - D. Laser cutting apertures with trapezoidal walls and also rounding corners will offer better paste release. Customers should contact their board assembly site for stencil design recommendations. Refer to IPC-7525 for other stencil recommendations.
 - E. Customers should contact their board fabrication site for solder mask tolerances between and around signal pads.

IMPORTANT NOTICE AND DISCLAIMER

TI PROVIDES TECHNICAL AND RELIABILITY DATA (INCLUDING DATASHEETS), DESIGN RESOURCES (INCLUDING REFERENCE DESIGNS), APPLICATION OR OTHER DESIGN ADVICE, WEB TOOLS, SAFETY INFORMATION, AND OTHER RESOURCES "AS IS" AND WITH ALL FAULTS, AND DISCLAIMS ALL WARRANTIES, EXPRESS AND IMPLIED, INCLUDING WITHOUT LIMITATION ANY IMPLIED WARRANTIES OF MERCHANTABILITY, FITNESS FOR A PARTICULAR PURPOSE OR NON-INFRINGEMENT OF THIRD PARTY INTELLECTUAL PROPERTY RIGHTS.

These resources are intended for skilled developers designing with TI products. You are solely responsible for (1) selecting the appropriate TI products for your application, (2) designing, validating and testing your application, and (3) ensuring your application meets applicable standards, and any other safety, security, or other requirements. These resources are subject to change without notice. TI grants you permission to use these resources only for development of an application that uses the TI products described in the resource. Other reproduction and display of these resources is prohibited. No license is granted to any other TI intellectual property right or to any third party intellectual property right. TI disclaims responsibility for, and you will fully indemnify TI and its representatives against, any claims, damages, costs, losses, and liabilities arising out of your use of these resources.

TI's products are provided subject to TI's Terms of Sale (www.ti.com/legal/termsofsale.html) or other applicable terms available either on ti.com or provided in conjunction with such TI products. TI's provision of these resources does not expand or otherwise alter TI's applicable warranties or warranty disclaimers for TI products.

Mailing Address: Texas Instruments, Post Office Box 655303, Dallas, Texas 75265
Copyright © 2020, Texas Instruments Incorporated