

FEATURES

Converts a low frequency input reference signal to a high frequency output signal

Input frequencies from 6.6 MHz to 112.5 MHz

Output frequencies up to 900 MHz

Preset pin programmable frequency translation ratios

Arbitrary frequency translation ratios via SPI port

On-chip VCO

Accepts a crystal resonator and/or an external oscillator as a reference frequency source

Secondary output (either integer-related to the primary output or a copy of the reference input)

RMS jitter: <0.5 ps

SPI-compatible, 3-wire programming interface

Single supply (3.3 V)

Very low power: <400 mW (under most conditions)

Small package size (5 mm × 5 mm)

APPLICATIONS

Cost effective replacement of high frequency VCXO, OCXO, and SAW resonators

Extremely flexible frequency translation with low jitter for SONET/SDH (including FEC), 10 Gb Ethernet, Fibre Channel, and DRFI/DOCSIS

High-definition video frequency translation

Wireless infrastructure

Test and measurement (including handheld devices)

GENERAL DESCRIPTION

The AD9552 is a fractional-N phase locked loop (PLL) based clock generator designed specifically to replace high frequency crystal oscillators and resonators. The device employs a sigma-delta (Σ - Δ) modulator (SDM) to accommodate fractional frequency synthesis. The user supplies an input reference signal by connecting a single-ended clock signal directly to the REF pin or by connecting a crystal resonator across the XTAL pins.

The AD9552 is pin programmable, providing one of 64 standard output frequencies based on one of eight common input frequencies. The device also has a 3-wire SPI interface, enabling the user to program custom input-to-output frequency ratios.

The AD9552 relies on an external capacitor to complete the loop filter of the PLL. The output is compatible with LVPECL, LVDS, or single-ended CMOS logic levels, although the AD9552 is implemented in a strictly CMOS process.

The AD9552 is specified to operate over the extended industrial temperature range of -40°C to $+85^{\circ}\text{C}$.

BASIC BLOCK DIAGRAM

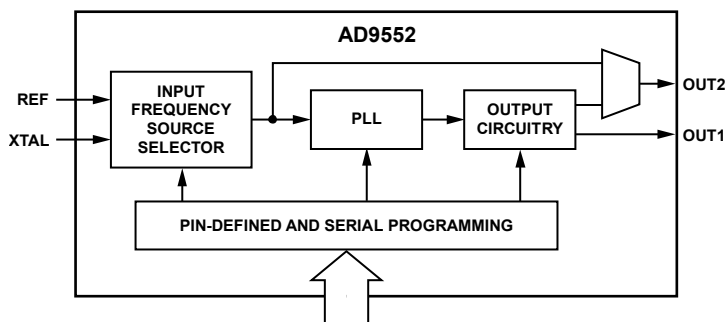

Figure 1.

07865-001

Rev. E

Document Feedback

Information furnished by Analog Devices is believed to be accurate and reliable. However, no responsibility is assumed by Analog Devices for its use, nor for any infringements of patents or other rights of third parties that may result from its use. Specifications subject to change without notice. No license is granted by implication or otherwise under any patent or patent rights of Analog Devices. Trademarks and registered trademarks are the property of their respective owners.

TABLE OF CONTENTS

Features	1	Preset Frequency Ratios	13
Applications.....	1	Component Blocks.....	15
General Description	1	Part Initialization and Automatic Power-On Reset.....	17
Basic Block Diagram	1	Output/Input Frequency Relationship	17
Revision History	2	Calculating Divider Values	17
Specifications.....	3	Low Dropout (LDO) Regulators	18
Crystal Input Characteristics	4	Applications Information	19
Output Characteristics.....	4	Thermal Performance.....	19
Jitter Characteristics.....	5	Serial Control Port	20
Serial Control Port	6	Serial Control Port Pin Descriptions.....	20
Serial Control Port Timing	6	Operation of the Serial Control Port	20
Absolute Maximum Ratings.....	7	Instruction Word (16 Bits).....	21
ESD Caution.....	7	MSB/LSB First Transfers	21
Pin Configuration and Function Descriptions.....	8	Register Map	23
Typical Performance Characteristics	9	Register Map Descriptions.....	24
Input/Output Termination Recommendations	12	Outline Dimensions	30
Theory of Operation	13	Ordering Guide	30

REVISION HISTORY

11/12—Rev. D to Rev. E

Changes to Figure 2.....	8
Changes to Serial Control Port Section	20
Changes to Table 17.....	24
Changes to Table 18.....	25
Updated Outline Dimensions (Changed CP-32-2 to CP-32-7)	31
Changes to Ordering Guide	31

7/11—Rev. C to Rev. D

Changes to Table 1, Reference Clock Input Characteristics, Input High Voltage and Input Low Voltage Parameter Values... 4	4
Changes to Table 8, Added Endnote for Pin 9 and Pin 10.....	8
Changes to Part Initialization Automatic Power-On Reset Section, Second Paragraph	17
Changes to Thermal Performance Section , First Paragraph ...	19
Changes to Serial Port Control Section, First Paragraph	20
Changes to Table 20, Added Endnote to Bit 2 Description	27
Updated Outline Dimensions	31

7/10—Rev. B to Rev. C

Changed Crystal Load Capacitance to 15 pF..... Throughout	
Added Conditions Statement to Specifications Section, Supply Voltage Specifications, and Input Voltage Specifications	3
Reformatted Specifications Section (Renumbered Sequentially).....	3
Added Input/Output Termination Recommendations Section, Figure 17, and Figure 18 (Renumbered Sequentially)	13

Moved Preset Frequency Ratios Section	13
Changes to Component Blocks Section	15
Added Part Initialization and Automatic Power-On Reset Section	17

4/10—Rev. A to Rev. B

Changes to Preset Frequency Ratios Section.....	12
Moved Table 15 and Changes to Table 15	13
Changes to Figure 17.....	14
Changes to PLL Section, Output Dividers Section, and Input-to-OUT2 Option Section	15
Changes to Output/Input Frequency Relationship Section.....	16
Changes to Table 22	23
Changes to Table 26	26

9/09—Rev. 0 to Rev. A

Changes to Table 4.....	3
Changes to Table 5.....	4
Added Table 6; Renumbered Sequentially	4
Changes to Figure 5.....	9
Changes to PLL Section.....	14
Changes to Table 22	21
Changes to Table 25	24

7/09—Revision 0: Initial Version

SPECIFICATIONS

Minimum (min) and maximum (max) values apply for the full range of supply voltage and operating temperature variations. Typical (typ) values apply for $V_{DD} = 3.3\text{ V}$; $T_A = 25^\circ\text{C}$, unless otherwise noted.

Table 1.

Parameter	Min	Typ	Max	Unit	Test Conditions/Comments
SUPPLY VOLTAGE	3.135	3.30	3.465	V	Pin 7, Pin 18, Pin 21, Pin 28
POWER CONSUMPTION					
Total Current		149	169	mA	At maximum output frequency with both output channels active
VDD Current By Pin					
Pin 7		2	3	mA	
Pin 18		77	86	mA	
Pin 21		35	41	mA	
Pin 28		35	41	mA	
LVPECL Output Driver		36	41	mA	900 MHz with 100 Ω termination between both pins of the output driver
LOGIC INPUT PINS					
INPUT CHARACTERISTICS ¹					
Logic 1 Voltage, V_{IH}	1.0			V	For the CMOS inputs, a static Logic 1 results from either a pull-up resistor or no connection
Logic 0 Voltage, V_{IL}			0.8	V	
Logic 1 Current, I_{IH}			3	μA	
Logic 0 Current, I_{IL}			17	μA	
LOGIC OUTPUT PINS					
Output Characteristics					
Output Voltage High, V_{OH}	2.7			V	
Output Voltage Low, V_{OL}			0.4	V	
RESET PIN					
Input Characteristics ²					
Input Voltage High, V_{IH}	1.8			V	
Input Voltage Low, V_{IL}			1.3	V	
Input Current High, I_{INH}		0.3	12.5	μA	
Input Current Low, I_{INL}		31	43	μA	
Minimum Pulse Width High	2			ns	
REFERENCE CLOCK INPUT CHARACTERISTICS					
Frequency Range	7.94			MHz	$N^3 = 255$; 2 \times frequency multiplier enabled; valid for all VCO bands
	6.57			MHz	$N^3 = 255$; 2 \times frequency multiplier enabled; $f_{VCO} = 3.35\text{ GHz}$, which constrains the frequency at OUT1 to be an integer sub-multiple of 3.35 GHz (that is, $f_{OUT1} = 3.35 \div M\text{ GHz}$, where M is the product of the P_0 and P_1 output divider values)
			93.06	MHz	SDM ⁴ disabled; $N^3 = 36^5$; valid for all VCO bands
			71.28	MHz	SDM ⁴ enabled; $N^3 = 47^6$; valid for all VCO bands
			112.5	MHz	SDM ⁴ disabled; $N^3 = 36^5$; $f_{VCO} = 4.05\text{ GHz}$, which constrains the frequency at OUT1 to be an integer sub-multiple of 4.05 GHz (that is, $f_{OUT1} = 4.05 \div M\text{ GHz}$, where M is the product of the P_0 and P_1 output divider values)
			86.17	MHz	SDM ⁴ enabled; $N^3 = 47^6$; $f_{VCO} = 4.05\text{ GHz}$, which constrains the frequency at OUT1 to be an integer sub-multiple of 4.05 GHz (that is, $f_{OUT1} = 4.05 \div M\text{ GHz}$, where M is the product of the P_0 and P_1 output divider values)

Parameter	Min	Typ	Max	Unit	Test Conditions/Comments
Input Capacitance		3		pF	
Input Resistance		130		k Ω	
Duty Cycle	40		60	%	
Input Voltage					
Input High Voltage, V_{IH}	1.62			V	
Input Low Voltage, V_{IL}			0.52	V	
Input Threshold Voltage		1.0		V	When ac coupling to the input receiver, the user must dc bias the input to 1 V
VCO CHARACTERISTICS					
Frequency Range					
Upper Bound		4050		MHz	
Lower Bound		3350		MHz	
VCO Gain		45		MHz/V	
VCO Tracking Range	± 300			ppm	
VCO Calibration Time		140		μ s	$f_{PFD}^7 = 77.76$ MHz; time between completion of the VCO calibration command (the rising edge of CS (Pin 12)) to the rising edge of LOCKED (Pin 20).

¹ The A[2:0], Y[5:0], and OUTSEL pins have 100 k Ω internal pull-up resistors.

² The RESET pin has a 100 k Ω internal pull-up resistor, so the default state of the device is reset.

³ N is the integer part of the feedback divider.

⁴ Sigma-delta modulator.

⁵ The minimum allowable feedback divider value with the SDM disabled.

⁶ The minimum allowable feedback divider value with the SDM enabled.

⁷ The frequency at the input to the phase-frequency detector.

CRYSTAL INPUT CHARACTERISTICS

Table 2.

Parameter	Min	Typ	Max	Unit	Test Conditions/Comments
CRYSTAL FREQUENCY					
Range	10	26	52	MHz	
Tolerance			20	ppm	
CRYSTAL MOTIONAL RESISTANCE			100	Ω	
CRYSTAL LOAD CAPACITANCE		15		pF	Using a crystal with a specified load capacitance other than 15 pF (8 pF to 24 pF) is possible, but necessitates using the SPI port to configure the AD9552 crystal input capacitance.

OUTPUT CHARACTERISTICS

Table 3.

Parameter	Min	Typ	Max	Unit	Test Conditions/Comments
LVPECL MODE					
Differential Output Voltage Swing	690	765	889	mV	Output driver static
Common-Mode Output Voltage	$V_{DD} - 1.77$	$V_{DD} - 1.66$	$V_{DD} - 1.20$	V	Output driver static
Frequency Range	0		900	MHz	
Duty Cycle	40		60	%	Up to 805 MHz output frequency
Rise/Fall Time ¹ (20% to 80%)		255	305	ps	100 Ω termination between both pins of the output driver

Parameter	Min	Typ	Max	Unit	Test Conditions/Comments
LVDS MODE					
Differential Output Voltage Swing Balanced, V_{OD}	247		454	mV	Voltage swing between output pins; output driver static
Unbalanced, ΔV_{OD}			25	mV	Absolute difference between voltage swing of normal pin and inverted pin; output driver static
Offset Voltage Common Mode, V_{OS}	1.125		1.375	V	Output driver static
Common-Mode Difference, ΔV_{OS}			25	mV	Voltage difference between output pins; output driver static
Short-Circuit Output Current		17	24	mA	
Frequency Range	0		900	MHz	
Duty Cycle	40		60	%	Up to 805 MHz output frequency
Rise/Fall Time ¹ (20% to 80%)		285	355	ps	100 Ω termination between both pins of the output driver
CMOS MODE					
Output Voltage High, V_{OH}					Output driver static; standard drive strength setting
$I_{OH} = 10$ mA	2.8			V	
$I_{OH} = 1$ mA	2.8			V	
Output Voltage Low, V_{OL}					Output driver static; standard drive strength setting
$I_{OL} = 10$ mA			0.5	V	
$I_{OL} = 1$ mA			0.3	V	
Frequency Range	0		200	MHz	3.3 V CMOS; standard drive strength setting
Duty Cycle	45		55	%	At maximum output frequency
Rise/Fall Time ¹ (20% to 80%)		500	745	ps	3.3 V CMOS; standard drive strength setting; 15 pF load

¹ The listed values are for the slower edge (rise or fall).

JITTER CHARACTERISTICS

Table 4.

Parameter	Min	Typ	Max	Unit	Test Conditions/Comments
JITTER GENERATION					Input = 19.44 MHz crystal resonator
12 kHz to 20 MHz		0.64		ps rms	$f_{OUT} = 622.08$ MHz (integer mode)
		0.70		ps rms	$f_{OUT} = 625$ MHz (fractional mode)
50 kHz to 80 MHz		0.47		ps rms	$f_{OUT} = 622.08$ MHz (integer mode)
		0.50		ps rms	$f_{OUT} = 625$ MHz (fractional mode)
4 MHz to 80 MHz		0.11		ps rms	$f_{OUT} = 622.08$ MHz (integer mode)
		0.12		ps rms	$f_{OUT} = 625$ MHz (fractional mode)
JITTER TRANSFER BANDWIDTH		100		kHz	See the Typical Performance Characteristics section
JITTER TRANSFER PEAKING		0.3		dB	See the Typical Performance Characteristics section

SERIAL CONTROL PORT

Table 5.

Parameter	Min	Typ	Max	Unit	Test Conditions/Comments
\overline{CS}					
Input Logic 1 Voltage	1.6			V	
Input Logic 0 Voltage			0.5	V	
Input Logic 1 Current			0.03	μA	
Input Logic 0 Current		2		μA	
Input Capacitance		2		pF	
SCLK					
Input Logic 1 Voltage	1.6			V	
Input Logic 0 Voltage			0.5	V	
Input Logic 1 Current		2		μA	
Input Logic 0 Current			0.03	μA	
Input Capacitance		2		pF	
SDIO					
Input					
Input Logic 1 Voltage	1.6			V	
Input Logic 0 Voltage			0.5	V	
Input Logic 1 Current		1		μA	
Input Logic 0 Current		1		μA	
Input Capacitance		2		pF	
Output					
Output Logic 1 Voltage	2.8			V	1 mA load current
Output Logic 0 Voltage			0.3	V	1 mA load current

SERIAL CONTROL PORT TIMING

Table 6.

Parameter	Limit	Unit
SCLK		
Clock Rate, $1/t_{\text{CLK}}$	50	MHz max
Pulse Width High, t_{HIGH}	3	ns min
Pulse Width Low, t_{LOW}	3	ns min
SDIO to SCLK Setup, t_{DS}	4	ns min
SCLK to SDIO Hold, t_{DH}	0	ns min
SCLK to Valid SDIO, t_{DV}	13	ns max
\overline{CS} to SCLK Setup (t_{S}) and Hold (t_{H})	0	ns min
\overline{CS} Minimum Pulse Width High	6.4	ns min

ABSOLUTE MAXIMUM RATINGS

Table 7.

Parameter	Rating
Supply Voltage (VDD)	3.6 V
Maximum Digital Input Voltage	-0.5 V to VDD + 0.5 V
Storage Temperature	-65°C to +150°C
Operating Temperature Range	-40°C to +85°C
Lead Temperature (Soldering, 10 sec)	300°C
Junction Temperature	150°C

Stresses above those listed under Absolute Maximum Ratings may cause permanent damage to the device. This is a stress rating only; functional operation of the device at these or any other conditions above those indicated in the operational section of this specification is not implied. Exposure to absolute maximum rating conditions for extended periods may affect device reliability.

ESD CAUTION



ESD (electrostatic discharge) sensitive device. Charged devices and circuit boards can discharge without detection. Although this product features patented or proprietary protection circuitry, damage may occur on devices subjected to high energy ESD. Therefore, proper ESD precautions should be taken to avoid performance degradation or loss of functionality.

PIN CONFIGURATION AND FUNCTION DESCRIPTIONS

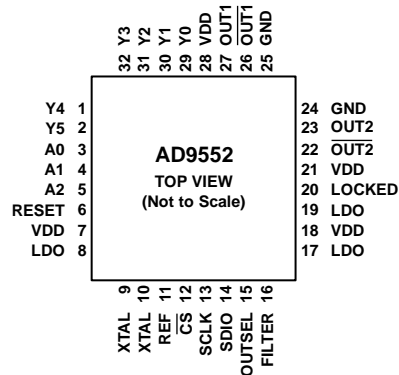

NOTES
1. EXPOSED DIE PAD MUST BE CONNECTED TO GND.

07806-002

Figure 2. Pin Configuration

Table 8. Pin Function Descriptions

Pin No.	Mnemonic	Type ¹	Description
29, 30, 31, 32, 1, 2	Y0, Y1, Y2, Y3, Y4, Y5	I	Control Pins. These pins select preset values for the PLL feedback divider and the OUT1 dividers based on the input reference frequency selected via the A[0:2] pins and have internal 100 kΩ pull-up resistors.
3, 4, 5	A0, A1, A2	I	Control Pins. These pins select the input reference frequency and have internal 100 kΩ pull-up resistors.
6	RESET	I	Digital Input, Active High. Resets internal logic to default states. This pin has an internal 100 kΩ pull-up resistor, so the default state of the device is reset.
7, 18, 21, 28	VDD	P	Power Supply Connection: 3.3 V Analog Supply.
8, 17, 19	LDO	P/O	LDO Decoupling Pins. Connect a 0.47 μF decoupling capacitor from each of these pins to ground.
9, 10	XTAL	I	Crystal Resonator Input. Connect a crystal resonator across these pins. ²
11	REF	I	Reference Clock Input. Connect this pin to an active clock input signal, or connect it to VDD when using a crystal resonator across the XTAL pins.
12	\overline{CS}	I	Digital Input, Active Low, Chip Select.
13	SCLK	I	Serial Data Clock.
14	SDIO	I/O	Digital Serial Data Input/Output.
15	OUTSEL	I	Logic 0 selects LVDS and Logic 1 selects LVPECL-compatible levels for both OUT1 and OUT2 when the outputs are not under SPI port control. Can be overridden via the programming registers. This pin has an internal 100 kΩ pull-up resistor.
16	FILTER	I/O	Loop Filter Node for the PLL. Connect an external 12 nF capacitor from this pin to Pin 17 (LDO).
20	LOCKED	O	Active High Locked Status Indicator for the PLL.
26, 22	$\overline{OUT1}, \overline{OUT2}$	O	Complementary Square Wave Clocking Outputs.
27, 23	OUT1, OUT2	O	Square Wave Clocking Outputs.
24, 25	GND	P	Analog Ground.
EP	Exposed Die Pad		The exposed die pad must be connected to GND.

¹ I = input, I/O = input/output, O = output, P = power, P/O = power/output.

² When no crystal is in use, leave these pins floating. The terminations are handled by internal circuitry.

TYPICAL PERFORMANCE CHARACTERISTICS

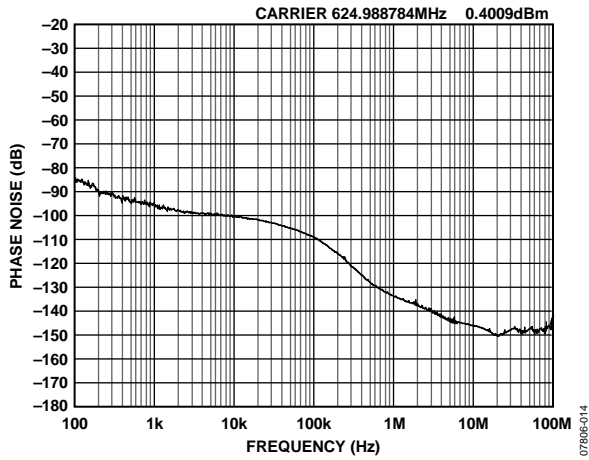

Figure 3. Phase Noise, Fractional-N, Pin Programmed ($f_{XTAL} = 19.44 \text{ MHz}$, $f_{OUT1} = 625 \text{ MHz}$)

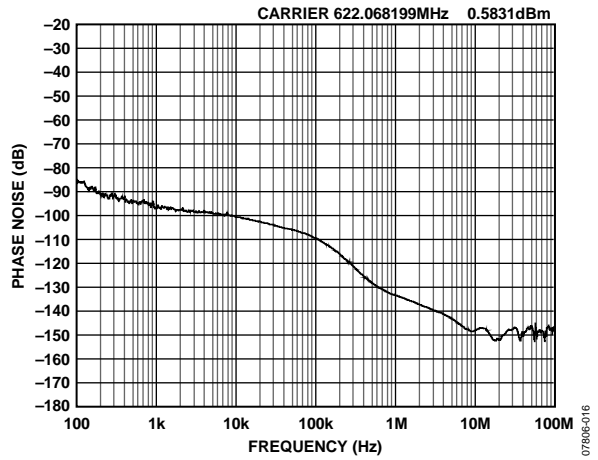

Figure 6. Phase Noise, Integer, SDM Off ($f_{XTAL} = 19.44 \text{ MHz}$, $f_{OUT1} = 622.08 \text{ MHz}$)

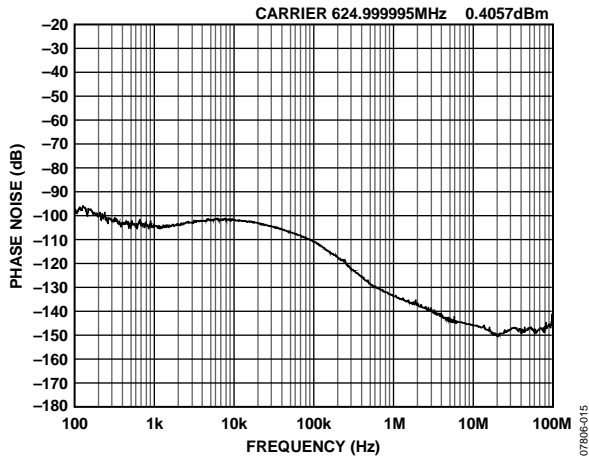

Figure 4. Phase Noise, Fractional-N, Pin Programmed ($f_{REF} = 19.44 \text{ MHz}$, $f_{OUT1} = 625 \text{ MHz}$)

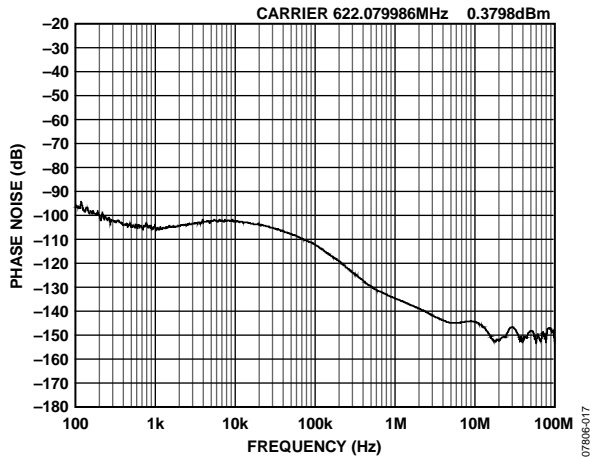

Figure 7. Phase Noise, Integer, SDM Off ($f_{REF} = 19.44 \text{ MHz}$, $f_{OUT1} = 622.08 \text{ MHz}$)

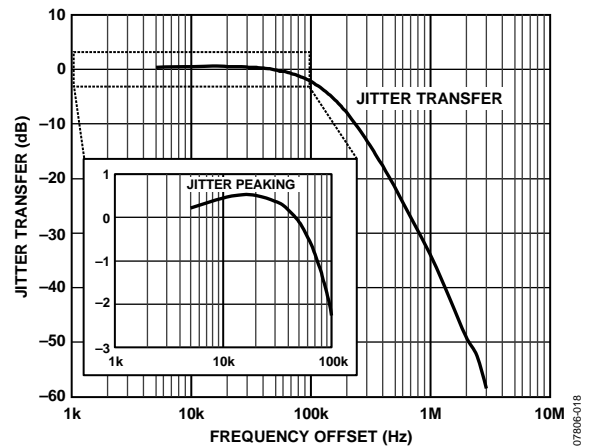

Figure 5. Jitter Transfer and Jitter Peaking

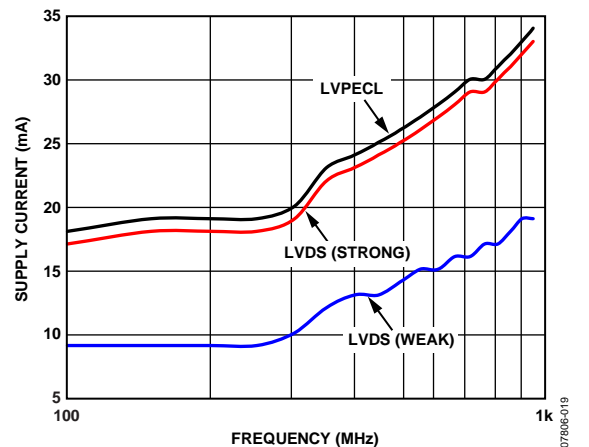

Figure 8. Supply Current vs. Output Frequency, LVPECL and LVDS (15 pF Load)

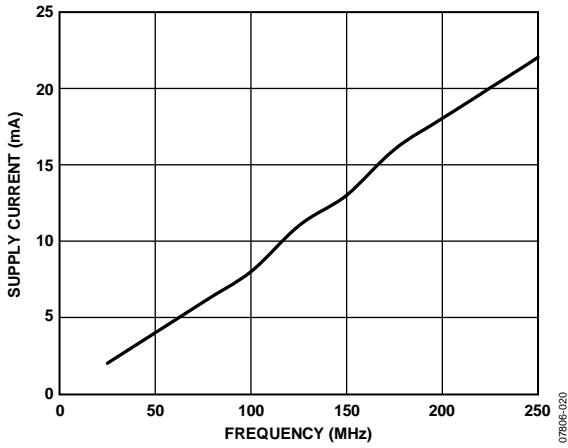

Figure 9. Supply Current vs. Output Frequency, CMOS (15 pF Load)

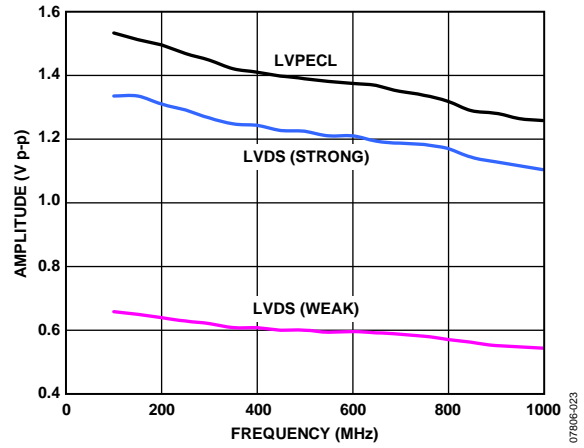

Figure 12. Peak-to-Peak Output Voltage vs. Frequency, LVPECL and LVDS (15 pF Load)

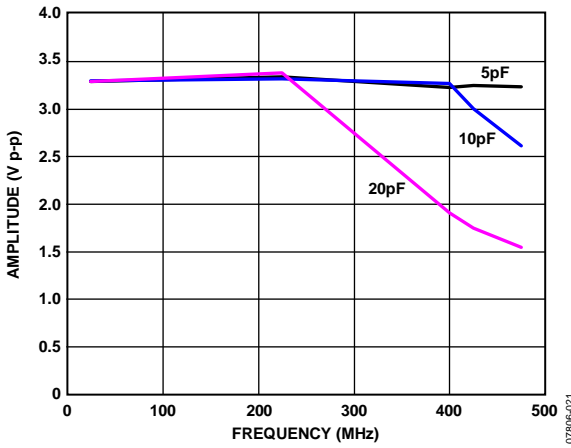

Figure 10. Peak-to-Peak Output Voltage vs. Frequency, CMOS

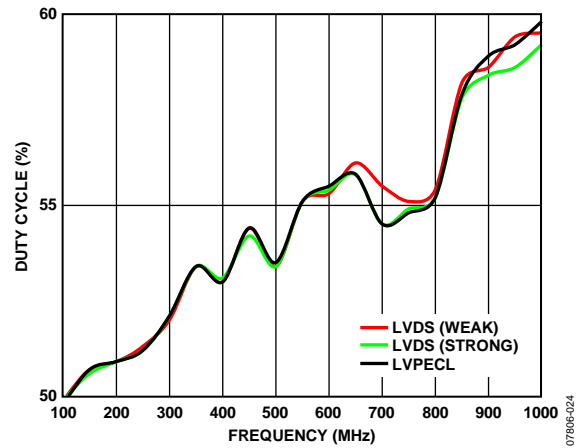

Figure 13. Duty Cycle vs. Output Frequency, LVPECL and LVDS (15 pF Load)

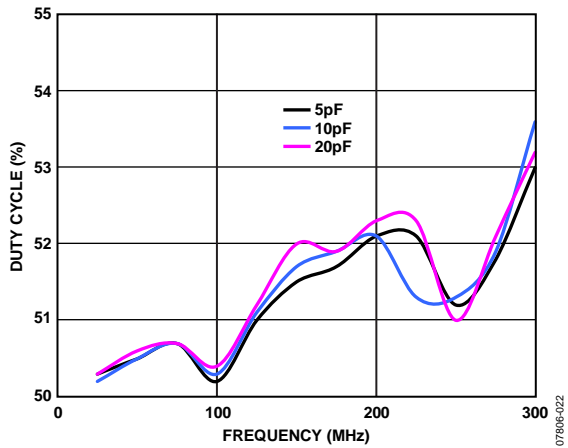

Figure 11. Duty Cycle vs. Output Frequency, CMOS

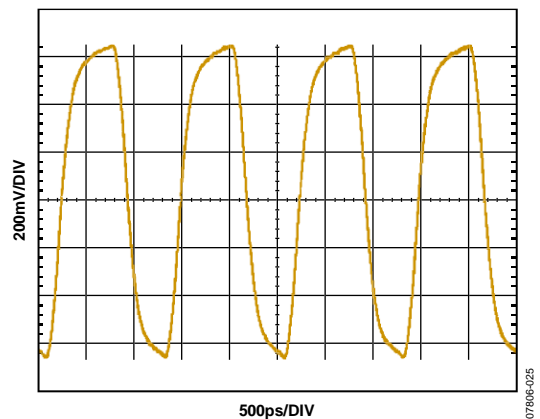

Figure 14. Typical Output Waveform, LVPECL (805 MHz)

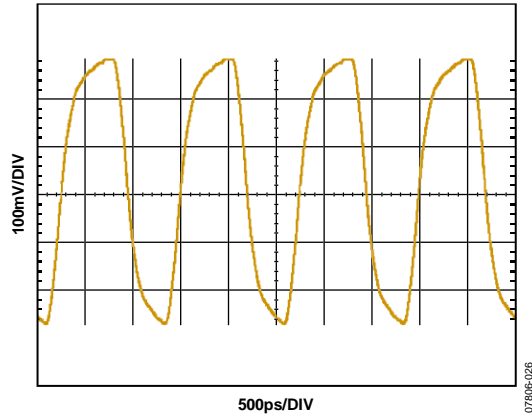

Figure 15. Typical Output Waveform, LVDS (805 MHz, 3.5 mA Drive Current)

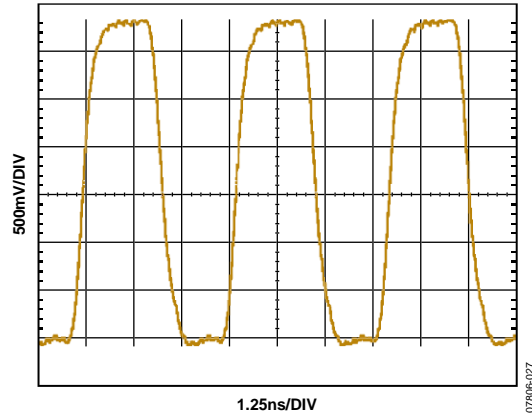

Figure 16. Typical Output Waveform, CMOS (250 MHz, 15 pF Load)

INPUT/OUTPUT TERMINATION RECOMMENDATIONS

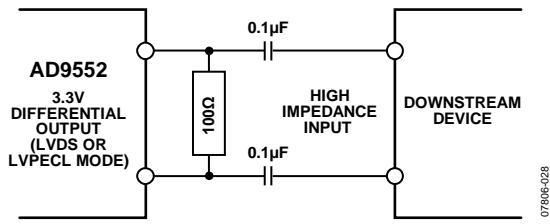

Figure 17. AC-Coupled LVDS or LVPECL Output Driver

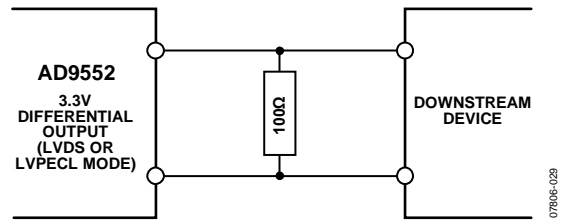

Figure 18. DC-Coupled LVDS or LVPECL Output Driver

THEORY OF OPERATION

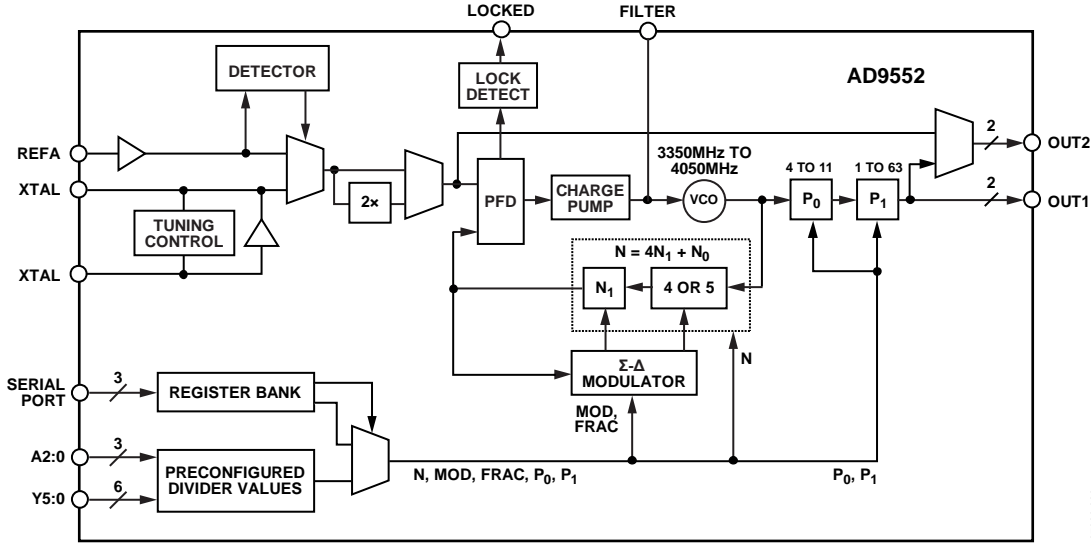

Figure 19. Detailed Block Diagram

PRESET FREQUENCY RATIOS

The frequency selection pins (A[2:0] and Y[5:0]) allow the user to hardwire the device for preset input and output divider values based on the pin logic states (see Figure 19). The pins decode ground or open connections as Logic 0 or Logic 1, respectively. Use the serial I/O port to change the divider values from the preset values provided by the A[2:0] and Y[5:0] pins.

The A[2:0] pins select one of eight input reference frequencies (see Table 9). The user supplies the input reference frequency by connecting a single-ended clock signal to the REF pin or a crystal resonator across the XTAL pins. If the A[2:0] pins select 10 MHz, 12 MHz, 12.8 MHz, or 16 MHz, the input frequency to the AD9552 doubles internally. Alternatively, if Register 0x1D[2] is set to 1, the input frequency doubles.

Table 9. Input Reference Frequency Selection Pins

A2	A1	A0	Reference Frequency (MHz)
0	0	0	10.00
0	0	1	12.00
0	1	0	12.80
0	1	1	16.00
1	0	0	19.20
1	0	1	19.44
1	1	0	20.00
1	1	1	26.00

The Y[5:0] pins select the appropriate feedback and output dividers to synthesize the output frequencies (see Table 10). The output frequencies provided in Table 10 are exact; that is, the number of decimal places displayed is sufficient to maintain full precision. Where a decimal representation is not practical, a fractional multiplier is used.

The VCO and output frequency shift in frequency by a ratio of the reference frequency used vs. the frequency specified in Table 9. Note that the VCO frequency must stay within the minimum and maximum range specified in Table 1. Typically, the selection of the VCO frequency band, as well as the gain adjustment, by the external pin strap occurs as part of the device’s automatic VCO calibration process, which initiates at power up (or reset). If the user changes the VCO frequency band via the SPI interface, however, a forced VCO calibration should be initiated by first enabling SPI control of the VCO calibration (Register 0x0E[2] = 1) and then writing a 1 to the calibrate VCO bit (Register 0x0E[7]).

Table 10. Output Frequency Selection Pins

Y5	Y4	Y3	Y2	Y1	Y0	VCO Frequency (MHz)	Output (MHz)
0	0	0	0	0	0	3732.48	51.84
0	0	0	0	0	1	3888	54
0	0	0	0	1	0	3840	60
0	0	0	0	1	1	3932.16	61.44
0	0	0	1	0	0	3750	62.5
0	0	0	1	0	1	3733.296	66.666
0	0	0	1	1	0	3560.439	74.17582
0	0	0	1	1	1	3564	74.25
0	0	1	0	0	0	3732.48	77.76
0	0	1	0	0	1	3932.16	98.304
0	0	1	0	1	0	4000	100
0	0	1	0	1	1	3825	106.25
0	0	1	1	0	0	3840	120
0	0	1	1	0	1	4000	125
0	0	1	1	1	0	3724	133
0	0	1	1	1	1	3732.48	155.52
0	1	0	0	0	0	3750	156.25
0	1	0	0	0	1	3825	159.375
0	1	0	0	1	0	3867.188	161.1328125
0	1	0	0	1	1	3944.531	10518.75/64
0	1	0	1	0	0	3999.086	155.52 × (15/14)
0	1	0	1	0	1	4015.959	155.52 × (255/237)
0	1	0	1	1	0	4023.878	167.6616
0	1	0	1	1	1	3554.742	177.7371
0	1	1	0	0	0	3932.16	245.76
0	1	1	0	0	1	4000	250
0	1	1	0	1	0	3732.48	311.04
0	1	1	0	1	1	3840	320
0	1	1	1	0	0	4000	400
0	1	1	1	0	1	3471.4	433.925
0	1	1	1	1	0	3718.75	531.25
0	1	1	1	1	1	3763.2	537.6
1	0	0	0	0	0	3984.375	569.1964
1	0	0	0	0	1	3732.48	622.08
1	0	0	0	1	0	3748.229	624.7048
1	0	0	0	1	1	3750	625
1	0	0	1	0	0	3763.978	622.08 × (239/237)
1	0	0	1	0	1	3779.927	629.9878
1	0	0	1	1	0	3840	640
1	0	0	1	1	1	3849.12	641.52
1	0	1	0	0	0	3867.188	625 × (66/64)
1	0	1	0	0	1	3944.531	657.421875
1	0	1	0	1	0	3961.105	657.421875 × (239/238)
1	0	1	0	1	1	3999.086	622.08 × (15/14)
1	0	1	1	0	0	4014.769	669.1281
1	0	1	1	0	1	4015.959	622.08 × (255/237)
1	0	1	1	1	0	4017.857	625 × (15/14)
1	0	1	1	1	1	4025.032	670.8386
1	1	0	0	0	0	4032.976	622.08 × (255/236)
1	1	0	0	0	1	3452.846	625 × (66/64) × (15/14)
1	1	0	0	1	0	3467.415	625 × (255/237) × (66/64)
1	1	0	0	1	1	3468.75	693.75
1	1	0	1	0	0	3481.996	622.08 × (253/226)
1	1	0	1	0	1	3521.903	657.421875 × (255/238)

Y5	Y4	Y3	Y2	Y1	Y0	VCO Frequency (MHz)	Output (MHz)
1	1	0	1	1	0	3536.763	$657.421875 \times (255/237)$
1	1	0	1	1	1	3582.686	716.5372
1	1	1	0	0	0	3593.75	718.75
1	1	1	0	0	1	3598.672	719.7344
1	1	1	0	1	0	3740.355	748.0709
1	1	1	0	1	1	3750	750
1	1	1	1	0	0	3888	777.6
1	1	1	1	0	1	3897.843	779.5686
1	1	1	1	1	0	3906.25	781.25
1	1	1	1	1	1	4028.32	$625 \times (10/8) \times (66/64)$

COMPONENT BLOCKS

Input Reference

The AD9552 offers the following input reference options:

- Crystal resonator connected directly across the XTAL pins
- CMOS-compatible, single-ended clock source connected directly to the REF pin

In the case of a crystal resonator, the AD9552 expects a crystal with a specified load capacitance of 15 pF (default). The AD9552 provides the load capacitance internally. The internal load capacitance consists of a fixed component of 13 pF and a variable (programmable) component of 0 pF to 15.75 pF.

After applying power to the AD9552 (or after a device reset), the programmable component assumes a value of 2 pF. This establishes the default load capacitance of 15 pF.

To accommodate crystals with a specified load capacitance other than 15 pF (8 pF to 23.75 pF), the user can adjust the programmable capacitance in 0.25 pF increments via Register 0x1B[5:0]. Note that when the user sets Register 0x1B[7] to 0 (enabling SPI control of the XTAL tuning capacitors), the variable capacitance changes from 2 pF (its power-up value) to 15.75 pF due to the default value of Register 0x1B[5:0]. This causes the crystal load capacitance to be 23.75 pF until the user overwrites the default contents of Register 0x1B[5:0].

A noncomprehensive, alphabetical list of crystal manufacturers includes the following:

- AVX/Kyocera
- ECS
- Epson Toyocom
- Fox Electronics
- NDK
- Siward

The AD9552 evaluation board functions with the NDK NX3225SA crystal or with the Siward 571200-A258-001 crystal. Although these crystals meet the load capacitance and motional resistance requirements of the AD9552 according to their data sheets, Analog Devices, Inc., does not guarantee their operation with the AD9552, nor does Analog Devices endorse one supplier of crystals over another.

Reference Monitor

The REF input includes a monitor circuit that detects signal presence at the REF input. If the device detects a clock signal on the REF pin, it automatically selects the REF input as the input reference source and shuts down the crystal oscillator. This automatic preference for a REF input signal is the default mode of operation. However, the user can override the default setting via Register 0x1D[0]. Setting this bit forces the device to override the signal detector associated with the REF input and activates the crystal oscillator (whether or not a REF input signal is present).

2× Frequency Multiplier

The 2× frequency multiplier provides the option to double the frequency delivered by either the REF or XTAL input. This allows the user to take advantage of a higher frequency delivered to the PLL, which allows for greater separation between the frequency generated by the PLL and the associated reference spur. However, increased reference spur separation comes at the expense of the harmonic spurs introduced by the frequency multiplier. As such, beneficial use of the frequency multiplier is application specific.

PLL

The PLL consists of a phase/frequency detector (PFD), a partially integrated analog loop filter (see Figure 20), an integrated voltage-controlled oscillator (VCO), and a feedback divider with an optional third-order SDM that allows for fractional divide ratios. The PLL produces a nominal 3.7 GHz signal that is phase-locked to the input reference signal.

The loop bandwidth of the PLL is nominally 50 kHz. The PFD of the PLL drives a charge pump that automatically changes current proportionately to the feedback divider value. This increase or decrease in current maintains a constant loop bandwidth with changes in the input reference or the output frequency.

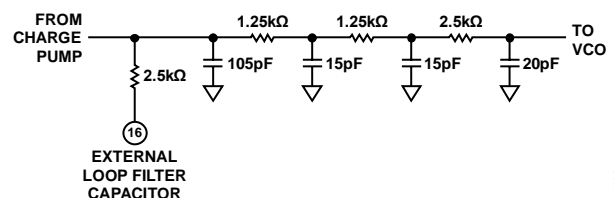

Figure 20. Internal Loop Filter

The gain of the PLL is proportional to the current delivered by the charge pump. The user can override the default charge pump current setting, and, thereby, the PLL gain, by using Register 0x0A[7:0].

The PLL has a VCO with 128 frequency bands spanning a range of 3350 MHz to 4050 MHz (3700 MHz nominal). However, the actual operating frequency within a particular band depends on the control voltage that appears on the loop filter capacitor. The control voltage causes the VCO output frequency to vary linearly within the selected band. This frequency variability allows the control loop of the PLL to synchronize the VCO output signal with the reference signal applied to the PFD. Typically, selection of the VCO frequency band (as well as gain adjustment) occurs automatically as part of the device's automatic VCO calibration process, which initiates at power up (or reset). Alternatively, the user can force VCO calibration by first enabling SPI control of VCO calibration (Register 0x0E[2] = 1) and then writing a 1 to the calibrate VCO bit (Register 0x0E[7]). To facilitate system debugging, the user can override the VCO band setting by first enabling SPI control of VCO band (Register 0x0E[0] = 1) and then writing the desired value to Register 0x10[7:1].

The PLL has a feedback divider coupled with a third-order SDM that enables the PLL to provide integer-plus-fractional frequency upconversion. The integer factor, N, is variable via an 8-bit programming register. The range of N is from N_{MIN} to 255, where N_{MIN} is 36 or 47 depending on whether the SDM is disabled or enabled, respectively. The SDM in the feedback path allows for a fractional divide value that takes the form of $N + F/M$, where N is the integer part (eight bits), M is the modulus (20 bits), and F is the fractional part (20 bits), with all three parameters being positive integers.

The feedback SDM gives the AD9552 the ability to support a wide range of output frequencies with exact frequency ratios relative to the input reference.

PLL Locked Indicator

The PLL provides a status indicator that appears at an external pin (LOCKED). The indicator shows when the PLL has acquired a locked condition.

Output Drivers

Two integer dividers exist in the output chain. The first divider (P_0) yields an integer submultiple of the VCO frequency. The second divider (P_1) establishes the frequency at OUT1 as an integer submultiple of the output frequency of the P_0 divider.

Input-to-OUT2 Option

By default, OUT2 delivers an output frequency that is the same frequency as OUT1. However, the user has the option of making OUT2 a replica of the input frequency (REF or XTAL) by programming Register 33[3] = 1.

Output Drivers

The user has control over the following output driver parameters via the programming registers:

- Logic family and pin functionality
- Polarity (for CMOS family only)
- Drive current
- Power-down

The logic families are LVDS, LVPECL, and CMOS. Selection of the logic family is via the mode control bits in the OUT1 driver control register (Register 0x32[5:3]) and the OUT2 driver control register (Register 0x34[5:3]), as detailed in Table 11. Regardless of the selected logic family, each output driver uses two pins: $\overline{OUT1}$ and $\overline{OUT2}$ are used by one driver, and OUT2 and $\overline{OUT2}$ are used by the other. This enables support of the differential signals associated with the LVDS and LVPECL logic families. CMOS, on the other hand, is a single-ended signal requiring only one output pin, but both output pins are available for optional provision of a dual, single-ended CMOS output clock. Refer to the first entry (CMOS (both pins)) in Table 11.

Table 11. Output Channel Logic Family and Pin Functionality

Mode Control Bits[2:0]	Logic Family and Pin Functionality
000	CMOS (both pins)
001	CMOS (positive pin), tristate (negative pin)
010	Tristate (positive pin), CMOS (negative pin)
011	Tristate (both pins)
100	LVDS
101	LVPECL
110	Undefined
111	Undefined

If the mode bits indicate the CMOS logic family, the user has control of the logic polarity associated with each CMOS output pin via the OUT1 and OUT2 driver control registers.

If the mode bits indicate the CMOS or LVDS logic family, the user can select whether the output driver uses weak or strong drive capability via the OUT1 and OUT2 driver control registers. In the case of the CMOS family, the strong setting allows for driving increased capacitive loads. In the case of the LVDS family, the nominal weak and strong drive currents are 3.5 mA and 7 mA, respectively.

The OUT1 and OUT2 driver control registers also have a power-down bit to enable/disable the output drivers. The power-down function is independent of the logic family selection.

Note that, unless the user programs the device to allow SPI port control of the output drivers, the drivers default to LVPECL or LVDS, depending on the logic level on the OUTSEL pin (Pin 15). For OUTSEL = 0, both outputs are LVDS. For OUTSEL = 1, both outputs are LVPECL. In the pin-selected LVDS mode, the user can still control the drive strength, using the SPI port.

PART INITIALIZATION AND AUTOMATIC POWER-ON RESET

The AD9552 has an internal power-on reset circuit. At power-up, internal logic relies on the internal reference monitor to select either the crystal oscillator or the reference input and then initiates VCO calibration using whichever is found. If both are present, the external reference path is chosen.

VCO calibration is required in order for the device to lock. If the input reference signal is not present, VCO calibration waits until a valid input reference is present. As soon as an input reference signal is present, VCO calibration starts. The user should wait at least 3 ms for the VCO calibration routine to finish before programming the VCO control register (Register 0x0E) via serial communication.

If the user wishes to use the crystal oscillator input even if the reference input is present, the user needs to set Bit 0 (use crystal resonator) in Register 0x1D.

Any change to the preset frequency selection pins or the PLL divide ratios requires the user to recalibrate the VCO.

OUTPUT/INPUT FREQUENCY RELATIONSHIP

The frequency at OUT1 and OUT2 is a function of the PLL feedback divider values (N , $FRAC$, and MOD) and the output divider values (P_0 and P_1). The equations that define the frequency at OUT1 and OUT2 (f_{OUT1} and f_{OUT2} , respectively) are as follows.

$$f_{OUT1} = f_{REF} \left(K \times \frac{N + \frac{FRAC}{MOD}}{P_0 P_1} \right)$$

$$f_{OUT2} = f_{OUT1}$$

where:

f_{REF} is the input reference or crystal resonator frequency.

K is the input mode scale factor.

N is the integer feedback divider value.

$FRAC$ and MOD are the fractional feedback divider values.

P_0 and P_1 are the OUT1 divider values.

The numerator of the f_{OUT1} equation contains the feedback division factor, which has an integer part (N) due to an integer divider along with an optional fractional part ($FRAC/MOD$) associated with the feedback SDM.

The following constraints apply:

$$N_{MIN} \in \{36, 47\}$$

$$N \in \{N_{MIN}, N_{MIN} + 1, \dots, 255\}$$

$$FRAC \in \{0, 1, \dots, 1,048,575\}$$

$$MOD \in \{1, 2, \dots, 1,048,575\}$$

$$K \in \{1, 2\}$$

$$P_0 \in \{4, 5, \dots, 11\}$$

$$P_1 \in \{1, 2, \dots, 63\}$$

Note that N_{MIN} and K can each be one of two values. The value of N_{MIN} depends on the state of the SDM. $N_{MIN} = 36$ when the SDM is disabled or $N_{MIN} = 47$ when it is enabled. The value of K depends on the $2\times$ frequency multiplier. $K = 1$ when the $2\times$ frequency multiplier is bypassed, or $K = 2$ when it is enabled.

The frequency at the input to the PFD (f_{PFD}) is calculated as follows:

$$f_{PFD} = K \times f_{REF}$$

The operating range of the VCO ($3.35 \text{ GHz} \leq f_{VCO} \leq 4.05 \text{ GHz}$) places the following constraint on f_{PFD} :

$$\left(\frac{3350}{N + \frac{FRAC}{MOD}} \right) \text{MHz} \leq f_{PFD} \leq \left(\frac{4050}{N + \frac{FRAC}{MOD}} \right) \text{MHz}$$

CALCULATING DIVIDER VALUES

This section provides a three-step procedure for calculating the divider values when given a specific f_{OUT1}/f_{REF} ratio (f_{REF} is the frequency of either the REF input signal source or the external crystal resonator). The computation process is described in general terms, but a specific example is provided for clarity. The example is based on a frequency control pin setting of $A[2:0] = 111$ (see Table 9) and $Y[5:0] = 101000$ (see Table 10), yielding the following:

$$f_{REF} = 26 \text{ MHz}$$

$$f_{OUT1} = 625 \times (66/64) \text{ MHz}$$

1. Determine the output divide factor (ODF).

Note that the VCO frequency (f_{VCO}) spans 3350 MHz to 4050 MHz. The ratio, f_{VCO}/f_{OUT1} , indicates the required ODF. Given the specified value of f_{OUT1} (~644.53 MHz) and the range of f_{VCO} , the ODF spans a range of 5.2 to 6.3. The ODF must be an integer, which means that ODF = 6 (because 6 is the only integer between 5.2 and 6.3).

2. Determine suitable values for P_0 and P_1 .

The ODF is the product of the two output dividers, so $ODF = P_0 P_1$. It has already been determined that $ODF = 6$ for the given example. Therefore, $P_0 P_1 = 6$ with the constraints that P_0 and P_1 are both integers and that $4 \leq P_0 \leq 11$ (see the Output/Input Frequency Relationship section). These constraints lead to the single solution: $P_0 = 6$ and $P_1 = 1$.

Although this particular example yields a single solution for the output divider values with $f_{OUT1} \approx 644.53 \text{ MHz}$, some f_{OUT1} frequencies result in multiple ODFs rather than just one. For example, if $f_{OUT1} = 100 \text{ MHz}$ the ODF ranges from 34 to 40. This leads to an assortment of possible values for P_0 and P_1 , as shown in Table 12.

Table 12. Combinations for P₀ and P₁

P ₀	P ₁	ODF (P ₀ × P ₁)
4	9	36
4	10	40
5	7	35
5	8	40
6	6	36
7	5	35
8	5	40
9	4	36
10	4	40

The P₀ and P₁ combinations listed in Table 12 are all equally valid. However, note that they yield only three valid ODF values (35, 36, and 40) from the original range of 34 to 40.

3. Determine the feedback divider values for the PLL.

Repeat this step for each ODF when multiple ODFs exist (for example, 35, 36, and 40 in the case of Table 12).

To calculate the feedback divider values for a given ODF, use the following equation:

$$\left(\frac{f_{OUT1}}{f_{REF}} \right) \times ODF = \frac{X}{Y}$$

Note that the left side of the equation contains variables with known quantities. Furthermore, the values are necessarily rational, so the left side is expressible as a ratio of two integers, X and Y. Following is an example equation.

$$\left(\frac{625 \left[\frac{66}{64} \right]}{26} \right) \times 6 = \frac{625(66)(6)}{26(64)} = \frac{247,500}{1664} = \frac{X}{Y}$$

In the context of the AD9552, X/Y is always an improper fraction. Therefore, it is expressible as the sum of an integer, N, and the proper fraction, R/Y (R and Y are integers).

$$\frac{X}{Y} = N + \frac{R}{Y}$$

$$\frac{247,500}{1664} = N + \frac{R}{Y}$$

This particular example yields N = 148, Y = 1664, and R = 1228. To arrive at this result, use long division to convert the improper fraction, X/Y, to an integer (N) and a proper fraction (R/Y). Note that dividing Y into X by means of long division yields an integer, N, and a remainder, R. The proper fraction has a numerator (R, the remainder) and a denominator (Y, the divisor), as shown in Figure 21.

$$\begin{array}{r} N \\ Y \overline{) X} \\ \underline{-NY} \\ R \end{array} \Rightarrow \frac{X}{Y} = N + \frac{R}{Y}$$

Figure 21. Example Long Division

It is imperative that long division be used to obtain the correct results. Avoid the use of a calculator or math program, because these do not always yield correct results due to internal rounding and/or truncation. Some calculators or math programs may be up to the task if they can handle very large integer operations, but such are not common.

In the example, N = 148 and R/Y = 1228/1664, which reduces to R/Y = 307/416. These values of N, R, and Y constitute the following respective feedback divider values:

N = 148, FRAC = 307, and MOD = 416.

The only caveat is that N and MOD must meet the constraints given in the Output/Input Frequency Relationship section.

In the example, FRAC is nonzero, so the division value is an integer plus the fractional component, FRAC/MOD. This implies that the feedback SDM is necessary as part of the feedback divider. If FRAC = 0, the feedback division factor is an integer and the SDM is not required (it can be bypassed).

Although the feedback divider values obtained in this way provide the proper feedback divide ratio to synthesize the exact output frequency, they may not yield optimal jitter performance at the final output. One reason for this is that the value of MOD defines the period of the SDM, which has a direct impact on the spurious output of the SDM. Specifically, in the spectral band from dc to f_{PFD}, the SDM exhibits spurs at intervals of f_{PFD}/MOD. Thus, the spectral separation (Δf) of the spurs associated with the feedback SDM is

$$\Delta f = \frac{f_{PFD}}{MOD}$$

Because the SDM is in the feedback path of the PLL, these spurs appear in the output signal as spurious components offset by Δf from f_{OUT1}. Therefore, a small MOD value produces relatively large spurs with relatively large frequency offsets from f_{OUT1}, whereas a large MOD value produces smaller spurs but more closely spaced to f_{OUT1}. Clearly, the value of MOD has a direct impact on the spurious content (that is, jitter) at OUT1.

Generally, the largest possible MOD value yields the smallest spurs. Thus, it is desirable to scale MOD and FRAC by the integer part of 2²⁰ divided by the value of MOD obtained previously. In the example, the value of MOD is 416, yielding a scale factor of 2520 (the integer part of 220/416). A scale factor of 2520 leads to FRAC = 307 × 2520 = 773,640 and MOD = 416 × 2520 = 1,048,320.

LOW DROPOUT (LDO) REGULATORS

The AD9552 is powered from a single 3.3 V supply and contains on-chip LDO regulators for each function to eliminate the need for external LDOs. To ensure optimal performance, each LDO output should have a 0.47 μF capacitor connected between its access pin and ground, and this capacitor should be kept as close to the device as possible.

APPLICATIONS INFORMATION

THERMAL PERFORMANCE

Table 13. Thermal Parameters for the 32-Lead LFCSP Package

Symbol	Thermal Characteristic Using a JEDEC51-7 Plus JEDEC51-5 2S2P Test Board ¹	Value ²	Unit
θ_{JA}	Junction-to-ambient thermal resistance, 0.0 m/sec airflow per JEDEC JESD51-2 (still air)	40.5	°C/W
θ_{JMA}	Junction-to-ambient thermal resistance, 1.0 m/sec airflow per JEDEC JESD51-6 (moving air)	35.4	°C/W
θ_{JMA}	Junction-to-ambient thermal resistance, 2.5 m/sec airflow per JEDEC JESD51-6 (moving air)	31.8	°C/W
θ_{JB}	Junction-to-board thermal resistance, 1.0 m/sec airflow per JEDEC JESD51-8 (moving air)	23.3	°C/W
θ_{JC}	Junction-to-case thermal resistance (die-to-heat sink) per MIL-Std 883, Method 1012.1	4.2	°C/W
Ψ_{JT}	Junction-to-top-of-package characterization parameter, 0 m/sec airflow per JEDEC JESD51-2 (still air)	0.4	°C/W

¹ The exposed pad on the bottom of the package must be soldered to ground to achieve the specified thermal performance.

² Results are from simulations. The PCB is a JEDEC multilayer type. Thermal performance for actual applications requires careful inspection of the conditions in the application to determine whether they are similar to those assumed in these calculations.

The AD9552 is specified for an ambient temperature (T_A). To ensure that T_A is not exceeded, an airflow source can be used. Use the following equation to determine the junction temperature on the application PCB:

$$T_J = T_{CASE} + (\Psi_{JT} \times P_D)$$

where:

T_J is the junction temperature (°C).

T_{CASE} is the case temperature (°C) measured by the customer at the top center of the package.

Ψ_{JT} is the value indicated in Table 13.

P_D is the power dissipation (see the Specifications section).

Values of θ_{JA} are provided for package comparison and PCB design considerations. θ_{JA} can be used for a first-order approximation of T_J using the following equation:

$$T_J = T_A + (\theta_{JA} \times P_D)$$

where T_A is the ambient temperature (°C).

Values of θ_{JC} are provided for package comparison and PCB design considerations when an external heat sink is required.

Values of θ_{JB} are provided for package comparison and PCB design considerations.

SERIAL CONTROL PORT

The AD9552 serial control port is a flexible, synchronous, serial communications port that allows an easy interface to many industry-standard microcontrollers and microprocessors. Single or multiple byte transfers are supported, as well as MSB first or LSB first transfer formats. The AD9552 serial control port is configured for a single bidirectional I/O pin (SDIO only).

The serial control port has two types of registers: read-only and buffered. Read-only registers are nonbuffered and ignore write commands. All writable registers are buffered (also referred to as mirrored) and require an I/O update to transfer the new values from a temporary buffer on the chip to the actual register. To invoke an I/O update, write a 1 to the I/O update bit found in Register 0x05[0]. Because any number of bytes of data can be changed before issuing an update command, the update simultaneously enables all register changes occurring since any previous update.

SERIAL CONTROL PORT PIN DESCRIPTIONS

SCLK (serial data clock) is the serial shift clock. This pin is an input. SCLK is used to synchronize serial control port reads and writes. Write data bits are registered on the rising edge of this clock, and read data bits are registered on the falling edge. This pin is internally pulled down by a 30 k Ω resistor to ground.

SDIO (digital serial data input/output) is a dual-purpose pin that acts as input only or as an input/output. The AD9552 defaults to bidirectional pins for I/O.

$\overline{\text{CS}}$ (chip select bar) is an active low control that gates the read and write cycles. When $\overline{\text{CS}}$ is high, SDIO is in a high impedance state. This pin is internally pulled up by a 100 k Ω resistor to 3.3 V. It should not be left floating. See the Operation of the Serial Control Port section on the use of the $\overline{\text{CS}}$ pin in a communication cycle.

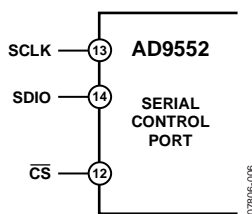

Figure 22. Serial Control Port

OPERATION OF THE SERIAL CONTROL PORT

Framing a Communication Cycle with $\overline{\text{CS}}$

The $\overline{\text{CS}}$ line gates the communication cycle (a write or a read operation). $\overline{\text{CS}}$ must be brought low to initiate a communication cycle.

The $\overline{\text{CS}}$ stall high function is supported in modes where three or fewer bytes of data (plus instruction data) are transferred. Bits[W1:W0] must be set to 00, 01, or 10 (see Table 14). In these modes, $\overline{\text{CS}}$ may temporarily return high on any byte boundary, allowing time for the system controller to process the next byte. $\overline{\text{CS}}$ can go high on byte boundaries only and can go high during either part (instruction or data) of the transfer. During this period,

the serial control port state machine enters a wait state until all data has been sent. If the system controller decides to abort before the complete transfer of all the data, the state machine must be reset either by completing the remaining transfer or by returning the $\overline{\text{CS}}$ line low for at least one complete SCLK cycle (but fewer than eight SCLK cycles). A rising edge on the $\overline{\text{CS}}$ pin on a nonbyte boundary terminates the serial transfer and flushes the buffer.

Table 14. Byte Transfer Count

W1	W0	Bytes to Transfer (Excluding the 2-Byte Instruction)
0	0	1
0	1	2
1	0	3
1	1	Streaming mode

In the streaming mode (Bits[W1:W0] = 11), any number of data bytes can be transferred in a continuous stream. The register address is automatically incremented or decremented (see the MSB/LSB First Transfers section). $\overline{\text{CS}}$ must be raised at the end of the last byte to be transferred, thereby ending the stream mode.

Communication Cycle—Instruction Plus Data

There are two parts to a communication cycle with the AD9552. The first part writes a 16-bit instruction word into the AD9552, coincident with the first 16 SCLK rising edges. The instruction word provides the AD9552 serial control port with information regarding the data transfer, which is the second part of the communication cycle. The instruction word defines whether the upcoming data transfer is a read or a write, the number of bytes in the data transfer, and the starting register address for the first byte of the data transfer.

Write

If the instruction word is for a write operation (Bit I15 = 0), the second part is the transfer of data into the serial control port buffer of the AD9552. The length of the transfer (1, 2, or 3 bytes; or streaming mode) is indicated by two bits (Bits[W1:W0]) in the instruction byte. The length of the transfer indicated by (Bits[W1:W0]) does not include the 2-byte instruction. $\overline{\text{CS}}$ can be raised after each sequence of eight bits to stall the bus (except after the last byte, where it ends the cycle). When the bus is stalled, the serial transfer resumes when $\overline{\text{CS}}$ is lowered. Stalling on nonbyte boundaries resets the serial control port.

Read

If the instruction word is for a read operation (Bit I15 = 1), the next $N \times 8$ SCLK cycles clock out the data from the address specified in the instruction word, where N is 1, 2, 3, or 4, as determined by Bits[W1:W0]. In this case, 4 is used for streaming mode, where four or more words are transferred per read. The data read back is valid on the falling edge of SCLK.

The default mode of the AD9552 serial control port is bidirectional mode, and the data read back appears on the SDIO pin.

By default, a read request reads the register value that is currently in use by the AD9552. However, setting Register 0x04[0] = 1 causes the buffered registers to be read instead. The buffered registers are the ones that take effect during the next I/O update.

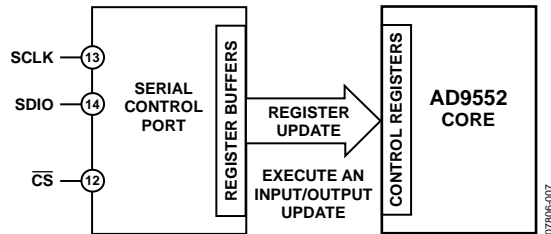

Figure 23. Relationship Between the Serial Control Port Register Buffers and the Control Registers

The AD9552 uses Register 0x00 to Register 0x34. Although the AD9552 serial control port allows both 8-bit and 16-bit instructions, the 8-bit instruction mode provides access to five address bits (Address Bits[A4:A0]) only, which restricts its use to Address Space 0x00 to Address Space 0x01. The AD9552 defaults to 16-bit instruction mode on power-up, and the 8-bit instruction mode is not supported.

INSTRUCTION WORD (16 BITS)

The MSB of the instruction word (see Table 15) is $\overline{R/W}$, which indicates whether the instruction is a read or a write. The next two bits, W1 and W0, are the transfer length in bytes. The final 13 bits are the address bits (Address Bits[A12:A0]) at which the read or write operation is to begin.

For a write, the instruction word is followed by the number of bytes of data indicated by Bits[W1:W0], which is interpreted according to Table 14.

Address Bits[A12:A0] select the address within the register map that is written to or read from during the data transfer portion of the communication cycle. The AD9552 uses all of the 13-bit address space. For multibyte transfers, this address is the starting byte address.

Table 15. Serial Control Port, 16-Bit Instruction Word, MSB First

MSB													LSB		
I15	I14	I13	I12	I11	I10	I9	I8	I7	I6	I5	I4	I3	I2	I1	I0
$\overline{R/W}$	W1	W0	A12	A11	A10	A9	A8	A7	A6	A5	A4	A3	A2	A1	A0

Table 16. Definition of Terms Used in Serial Control Port Timing Diagrams

Parameter	Description
t_{CLK}	Period of SCLK
t_{DV}	Read data valid time (time from falling edge of SCLK to valid data on SDIO)
t_{DS}	Setup time between data and rising edge of SCLK
t_{DH}	Hold time between data and rising edge of SCLK
t_S	Setup time between \overline{CS} and SCLK
t_H	Hold time between \overline{CS} and SCLK
t_{HIGH}	Minimum period that SCLK should be in a logic high state
t_{LOW}	Minimum period that SCLK should be in a logic low state

MSB/LSB FIRST TRANSFERS

The AD9552 instruction word and byte data can be MSB first or LSB first. The default for the AD9552 is MSB first. The LSB first mode can be set by writing a 1 to Register 0x00[6] and requires that an I/O update be executed. Immediately after the LSB first bit is set, all serial control port operations are changed to LSB first order.

When MSB first mode is active, the instruction and data bytes must be written from MSB to LSB. Multibyte data transfers in MSB first format start with an instruction byte that includes the register address of the most significant data byte. Subsequent data bytes must follow in order from high address to low address. In MSB first mode, the serial control port internal address generator decrements for each data byte of the multibyte transfer cycle.

When LSB first = 1 (LSB first), the instruction and data bytes must be written from LSB to MSB. Multibyte data transfers in LSB first format start with an instruction byte that includes the register address of the least significant data byte followed by multiple data bytes. The serial control port internal byte address generator increments for each data byte of the multibyte transfer cycle.

The AD9552 serial control port register address decrements from the register address just written toward 0x00 for multibyte I/O operations if the MSB first mode is active (default). If the LSB first mode is active, the serial control port register address increments from the address just written toward 0x34 for multibyte I/O operations.

Unused addresses are not skipped during multibyte I/O operations. The user should write the default value to a reserved register and should write only zeros to unmapped registers. Note that it is more efficient to issue a new write command than to write the default value to more than two consecutive reserved (or unmapped) registers.

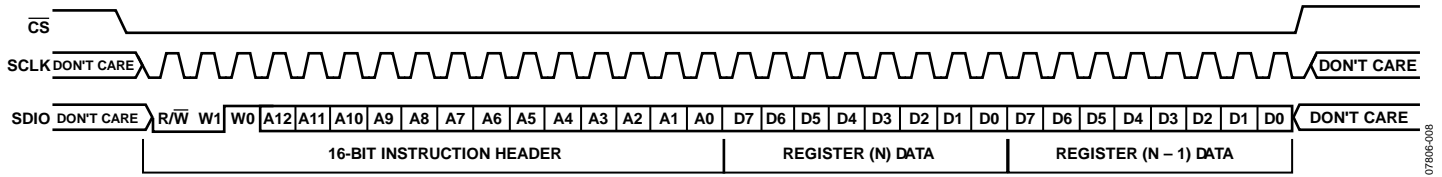

Figure 24. Serial Control Port Write—MSB First, 16-Bit Instruction, Two Bytes Data

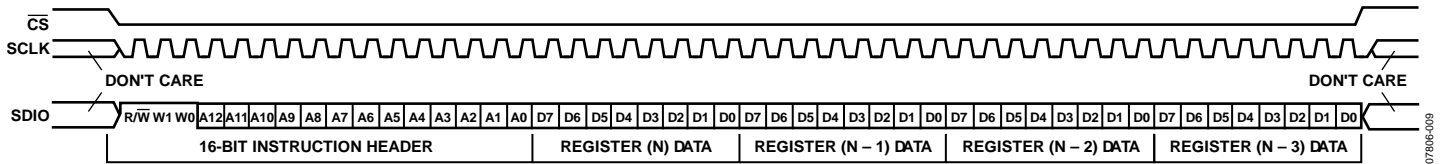

Figure 25. Serial Control Port Read—MSB First, 16-Bit Instruction, Four Bytes Data

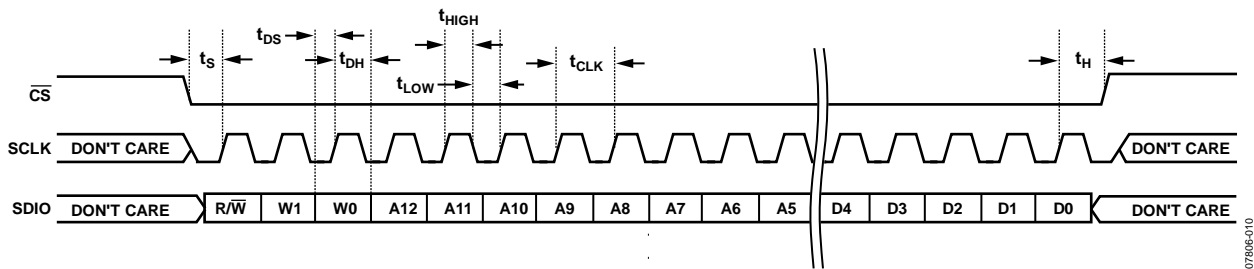

Figure 26. Serial Control Port Write—MSB First, 16-Bit Instruction, Timing Measurements

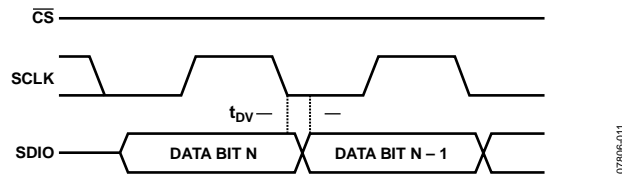

Figure 27. Timing Diagram for Serial Control Port Register Read

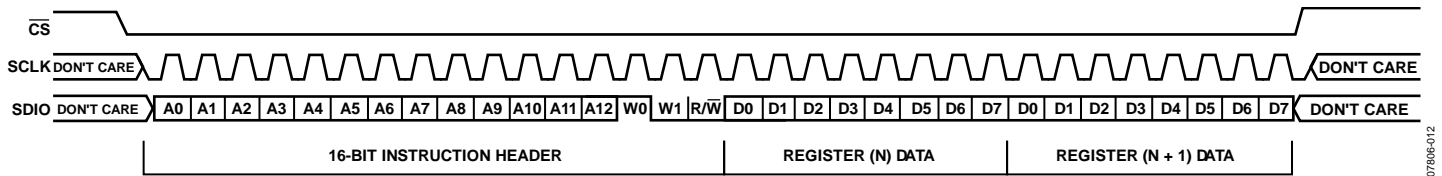

Figure 28. Serial Control Port Write—LSB First, 16-Bit Instruction, Two Bytes Data

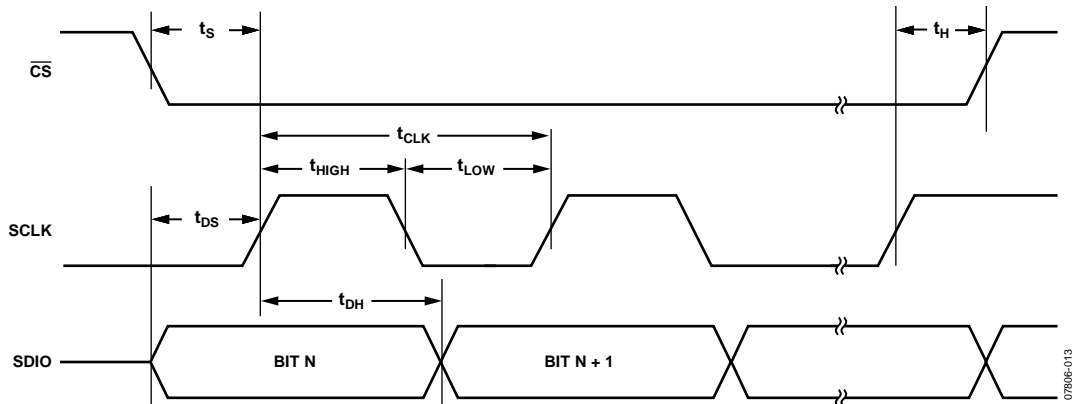

Figure 29. Serial Control Port Timing—Write

REGISTER MAP

A bit that is labeled “aclr” is an active high, autoclearing bit. When set to a Logic 1 state, the control logic automatically returns it to a Logic 0 state upon completion of the indicated task.

Table 17. Register Map

Addr. (Hex)	Register Name	(MSB) Bit 7	Bit 6	Bit 5	Bit 4	Bit 3	Bit 2	Bit 1	(LSB) Bit 0	Default
0x00	Serial port control	0	LSB first	Register map reset (aclr)	1	1	Register map reset	LSB first	0	0x18
0x04	Readback control	Unused	Unused	Unused	Unused	Unused	Unused	Unused	Readback control	0x00
0x05	I/O update	Unused	Unused	Unused	Unused	Unused	Unused	Unused	I/O update (aclr)	0x00
0x0A	PLL charge pump and PFD control	Charge pump current control[7:0] (3.5 μ A granularity, ~900 μ A full scale)								0x80
0x0B	PLL charge pump and PFD control	Enable SPI control of charge pump current	Enable SPI control of antibacklash period	CP mode[1:0]		Enable CP mode control	PFD feedback input edge control	PFD reference input edge control	Force VCO to midpoint frequency	0x30
0x0C	PLL charge pump and PFD control	Unused	CP offset current polarity	CP offset current[1:0]		Enable CP offset current control	Reserved	Reserved	Reserved	0x00
0x0D	PLL charge pump and PFD control	Antibacklash control[1:0]		Unused	Unused	Unused	Unused	Unused	PLL lock detector power-down	0x00
0x0E	VCO control	Calibrate VCO (aclr)	Enable ALC	ALC threshold[2:0]			Enable SPI control of VCO calibration	Boost VCO supply	Enable SPI control of VCO band setting	0x70
0x0F	VCO control	VCO level control[5:0]						Unused	Unused	0x80
0x10	VCO control	VCO band control[6:0]							Unused	0x80
0x11	PLL control	N[7:0] (SDM integer part)								0x00
0x12	PLL control	MOD[19:12] (SDM modulus)								0x80
0x13	PLL control	MOD[11:4] (SDM modulus)								0x00
0x14	PLL control	MOD[3:0] (SDM modulus)				Enable SPI control of output frequency	Bypass SDM	Disable SDM	Reset PLL	0x00
0x15	PLL control	FRAC[19:12] (SDM fractional part)								0x20
0x16	PLL control	FRAC[11:4] (SDM fractional part)								0x00
0x17	PLL control	FRAC[3:0] (SDM fractional part)				Unused	Unused	Unused	P ₁ divider[5]	0x01
0x18	PLL control	P ₁ divider[4:0]				P ₀ divider[2:0]				0x00
0x19	PLL control	Enable SPI control of OUT1 dividers	Unused	Unused						0x20
0x1A	Input receiver and band gap	Receiver reset (aclr)	Band gap voltage adjust[4:0] (00000 = maximum, 11111 = minimum)					Unused	Enable SPI control of band gap voltage	0x00
0x1B	XTAL tuning control	Disable SPI control of XTAL tuning	Unused	XTAL tuning capacitor control[5:0] (0.25 pF per bit, inverted binary coding)						0x80

Addr. (Hex)	Register Name	(MSB) Bit 7	Bit 6	Bit 5	Bit 4	Bit 3	Bit 2	Bit 1	(LSB) Bit 0	Default
		capacitance								
0x1C	XTAL control	Unused	Unused	Unused	Unused	Unused	Unused	Unused	Unused	0x00
0x1D	XTAL control	Unused	Unused	Unused	Unused	Unused	Select 2× frequency multiplier	Unused	Use crystal resonator	0x00
0x32	OUT1 driver control	OUT1 drive strength	OUT1 power-down	OUT1 mode control[2:0]			OUT1 CMOS polarity[1:0]		Enable SPI control of OUT1 driver control	0xA8
0x33	Select OUT2 source	Unused	Unused	Unused	Unused	OUT2 source	Unused	Unused	Unused	0x00
0x34	OUT2 driver control	OUT2 drive strength	OUT2 power-down	OUT2 mode control[2:0]			OUT2 CMOS polarity[1:0]		Enable SPI control of OUT2 driver control	0xA8

REGISTER MAP DESCRIPTIONS

Control bit functions are active high unless stated otherwise. Register address values are always hexadecimal unless otherwise indicated.

Serial Port Control (Register 0x00 to Register 0x05)

Table 18.

Address	Bit	Bit Name	Description
0x00	7	Unused	Forced to Logic 0 internally, which enables 3-wire mode only.
	6	LSB first	Bit order for SPI port. 0 = most significant bit and byte first (default). 1 = least significant bit and byte first.
	5	Register map reset	Resets the register map to the default values. This is an autoclearing bit.
	4	Unused	Forced to Logic 1 internally, which enables 16-bit mode (the only mode supported by the device).
	[3:0]	Unused	Mirrored version of the contents of Register 0x00[7:4] (that is, Bits[3:0] = Bits[7:4]).
0x04	[7:1]	Unused	Unused.
	0	Readback control	For buffered registers, serial port readback reads from actual (active) registers instead of from the buffer. 0 = reads values currently applied to the internal logic of the device (default). 1 = reads buffered values that take effect on next assertion of I/O update.
0x05	[7:1]	Unused	Unused.
	0	I/O update	Writing a 1 to this bit transfers the data in the serial I/O buffer registers to the internal control registers of the device. This is an autoclearing bit.

PLL Charge Pump and PFD Control (Register 0x0A to Register 0x0D)

Table 19.

Address	Bit	Bit Name	Description
0x0A	[7:0]	Charge pump current control	These bits set the magnitude of the PLL charge pump current. The granularity is ~3.5 μ A with a full-scale magnitude of ~900 μ A. Register 0x0A is ineffective unless Register 0x0B[7] = 1. Default is 0x80, or ~448 μ A.
0x0B	7	Enable SPI control of charge pump current	Controls functionality of Register 0x0A. 0 = the device automatically controls the charge pump current (default). 1 = charge pump current defined by Register 0x0A.
	6	Enable SPI control of antibacklash period	Controls functionality of Register 0x0D[7:6]. 0 = the device automatically controls the antibacklash period (default). 1 = antibacklash period defined by Register 0x0D[7:6].
	[5:4]	CP mode	Controls the mode of the PLL charge pump. 00 = tristate. 01 = pump up. 10 = pump down. 11 = normal (default).
	3	Enable CP mode control	Controls functionality of Bits[5:4] (CP mode). 0 = the device automatically controls the charge pump mode (default). 1 = charge pump mode is defined by Bits[5:4].
	2	PFD feedback input edge control	Selects the polarity of the active edge of the PLL's feedback input. 0 = positive edge (default). 1 = negative edge.
	1	PFD reference input edge control	Selects the polarity of the active edge of the PLL's reference input. 0 = positive edge (default). 1 = negative edge.
	0	Force VCO to midpoint frequency	Selects VCO control voltage functionality. 0 = normal VCO operation (default). 1 = force VCO control voltage to midscale.
0x0C	7	Unused	Unused.
	6	CP offset current polarity	Selects the polarity of the charge pump offset current of the PLL. This bit is ineffective unless Bit 3 = 1. 0 = pump up (default). 1 = pump down.
	[5:4]	CP offset current	Controls the magnitude of the charge pump offset current of the PLL as a fraction of the value in Register 0x0A. This bit is ineffective unless Bit 3 = 1. 00 = 1/2 (default). 01 = 1/4. 10 = 1/8. 11 = 1/16.
	3	Enable CP offset current control	Controls functionality of Bits[6:4]. 0 = the device automatically controls charge pump offset current (default). 1 = charge pump offset current defined by Bits[6:4].
	2:0	Reserved	
0x0D	[7:6]	Antibacklash control	Controls the PFD antibacklash period of the PLL. These bits are ineffective unless Register 0x0B[6] = 1. 00 = minimum (default). 01 = low. 10 = high. 11 = maximum.
	[5:1]	Unused	Unused.
	0	PLL lock detector power-down	Controls power-down of the PLL lock detector. 0 = lock detector active (default). 1 = lock detector powered down.

VCO Control (Register 0x0E to Register 0x10)

Table 20.

Address	Bit	Bit Name	Description
0x0E	7	Calibrate VCO	Initiates VCO calibration (this is an autoclearing bit). This bit is ineffective unless Bit 2 = 1.
	6	Enable ALC	Enables automatic level control (ALC) of the VCO. 0 = Register 0x0F[7:2] defines the VCO level. 1 = the device automatically controls the VCO level (default).
	[5:3]	ALC threshold	Controls the VCO ALC threshold detector level from minimum (000) to maximum (111). The default is 110.
	2	Enable SPI control of VCO calibration	Enables functionality of Bit 7 ¹ . 0 = the device automatically performs VCO calibration (default). 1 = Bit 7 controls VCO calibration.
	1	Boost VCO supply	Selects VCO supply voltage. 0 = normal supply voltage (default). 1 = increase supply voltage by 100 mV.
	0	Enable SPI control of VCO band setting	Controls VCO band setting functionality. 0 = the device automatically selects the VCO band (default). 1 = VCO band defined by Register 0x10[7:1].
0x0F	[7:2]	VCO level control	Controls the VCO amplitude from minimum (00 0000) to maximum (11 1111). The default is 10 0000. These bits are ineffective unless 0x0E[6] = 0.
	[1:0]	Unused	Unused.
0x10	[7:1]	VCO band control	Controls the VCO frequency band from minimum (000 0000) to maximum (111 1111). The default is 100 0000.
	0	Unused	Unused.

¹ An I/O update must be asserted after setting this bit and before issuing a SPI-controlled VCO calibration (writing 1 to Register 0x0E, Bit 7).

PLL Control (Register 0x11 to Register 0x19)

Table 21.

Address	Bit	Bit Name	Description
0x11	[7:0]	N	The 8-bit integer divide value for the SDM. Default is 0x00. Note that operational limitations impose a lower boundary of 64 (0x40) on N.
0x12	[7:0]	MOD	Bits[19:12] of the 20-bit modulus of the SDM.
0x13	[7:0]	MOD	Bits[11:4] of the 20-bit modulus of the SDM.
0x14	[7:4]	MOD	Bits[3:0] of the 20-bit modulus of the SDM. Default is MOD = 1000 0000 0000 0000 0000 (524,288).
	3	Enable SPI control of output frequency	Controls output frequency functionality. 0 = output frequency defined by the Y[3:0] pins (default). 1 = contents of Register 0x11 to Register 0x17 define output frequency via N, MOD, and FRAC.
	2	Bypass SDM	Controls bypassing of the SDM. 0 = allow integer-plus-fractional division (default). 1 = allow only integer division.
	1	Disable SDM	Controls the SDM internal clocks. 0 = normal operation (SDM clocks active) (default). 1 = SDM disabled (SDM clocks stopped).
	0	Reset PLL	Controls initialization of the PLL. 0 = normal operation (default). 1 = resets the counters and logic associated with the PLL but does not affect the output dividers.
0x15	[7:0]	FRAC	Bits[19:12] of the 20-bit fractional part of the SDM.
0x16	[7:0]	FRAC	Bits[11:4] of the 20-bit fractional part of the SDM.
0x17	[7:4]	FRAC	Bits[3:0] of the 20-bit fractional part of the SDM. Default is FRAC = 0010 0000 0000 0000 0000 (131,072).
	[3:1]	Unused	Write zeros to these bits when programming this register.
	0	P ₁ divider	Bit 5 of the 6-bit P ₁ divider for OUT1.

Address	Bit	Bit Name	Description
0x18	[7:3]	P ₁ divider	Bits[4:0] of the 6-bit P ₁ divider for OUT1 (1 ≤ P ₁ ≤ 63). Do not set these bits to 000000. Default is P ₁ = 10 0000 (32). The P ₁ bits are ineffective unless Register 0x19[7] = 1.
	[2:0]	P ₀ divider	The 3-bit P ₀ divider for OUT1. The P ₀ divide value is as follows: 000 = 4 (default). 001 = 5. 010 = 6. 011 = 7. 100 = 8. 101 = 9. 110 = 10. 111 = 11. The P ₀ bits are ineffective unless Register 0x19[7] = 1.
0x19	7	Enable SPI control of OUT1 dividers	Controls functionality of OUT1 dividers. 0 = OUT1 dividers defined by the Y[5:0] pins (default). 1 = contents of Register 0x17 and Register 0x18 define OUT1 dividers (P ₀ and P ₁).
	[6:0]	Unused	Unused.

Input Receiver and Band Gap Control (Register 0x1A)

Table 22.

Address	Bit	Bit Name	Description
0x1A	7	Receiver reset	Input receiver reset control. This is an autoclearing bit. 0 = normal operation (default). 1 = reset input receiver logic.
	[6:2]	Band gap voltage adjust	Controls the band gap voltage setting from minimum (0 0000) to maximum (1 1111). Default is 0 0000.
	1	Unused	Unused.
	0	Enable SPI control of band gap voltage	Enables functionality of Bits[6:2]. 0 = the device automatically selects receiver band gap voltage (default). 1 = Bits[6:2] define the receiver band gap voltage.

XTAL Control (Register 0x1B to Register 0x1D)

Table 23.

Address	Bit	Bit Name	Description
0x1B	7	Disable SPI control of XTAL tuning capacitance	Disables functionality of Bits[5:0]. 0 = tuning capacitance defined by Bits[5:0]. 1 = the device automatically selects XTAL tuning capacitance (default).
	6	Unused	Unused.
	[5:0]	XTAL tuning capacitor control	Capacitance value coded as inverted binary (0.25 pF per bit); that is, 111111 is 0 pF, 111110 is 0.25 pF, and so on. The default value, 000000, is 15.75 pF.
0x1C	[7:0]	Unused	Unused.
0x1D	[7:3]	Unused	Unused.
	2	Select 2× frequency multiplier	Select/bypass the 2× frequency multiplier. 0 = bypassed (default). 1 = selected.
	1	Unused	Unused.
	0	Use crystal resonator	Automatic external reference select override. 0 = the device automatically selects the external reference path if an external reference signal is present (default). 1 = the device uses the crystal resonator input whether or not an external reference signal is present.

OUT1 Driver Control (Register 0x32)

Table 24.

Address	Bit	Bit Name	Description
0x32	7	OUT1 drive strength	Controls the output drive capability of the OUT1 driver. 0 = weak. 1 = strong (default).
	6	OUT1 power-down	Controls power-down functionality of the OUT1 driver. 0 = OUT1 active (default). 1 = OUT1 powered down.
	[5:3]	OUT1 mode control	OUT1 driver mode selection. 000 = CMOS, both pins active. 001 = CMOS, positive pin active, negative pin tristate. 010 = CMOS, positive pin tristate, negative pin active. 011 = CMOS, both pins tristate. 100 = LVDS. 101 = LVPECL (default). 110 = not used. 111 = not used.
	[2:1]	OUT1 CMOS polarity	Selects the polarity of the OUT1 pins in CMOS mode. 00 = positive pin logic is true = 1, false = 0/negative pin logic is true = 0, false = 1 (default). 01 = positive pin logic is true = 1, false = 0/negative pin logic is true = 1, false = 0. 10 = positive pin logic is true = 0, false = 1/negative pin logic is true = 0, false = 1. 11 = positive pin logic is true = 0, false = 1/negative pin logic is true = 1, false = 0. These bits are ineffective unless Bits[5:3] select CMOS mode.
	0	Enable SPI control of OUT1 driver control	Controls OUT1 driver functionality. 0 = OUT1 is LVDS or LVPECL, per the OUTSEL pin (Pin 15) (default). 1 = OUT1 functionality defined by Bits[7:1].

Select OUT2 Source Control (Register 0x33)

Table 25.

Address	Bit	Bit Name	Description
0x33	[7:4]	Unused	Unused.
	3	OUT2 source	Selects the signal source for OUT2. 0 = source for OUT2 is the output of the P ₁ divider (default). 1 = source for OUT2 is the input reference (REF or XTAL).
	[2:0]	Unused	Unused.

OUT2 Driver Control (Register 0x34)

Table 26.

Address	Bit	Bit Name	Description
0x34	7	OUT2 drive strength	Controls the output drive capability of the OUT2 driver. 0 = weak. 1 = strong (default).
	6	OUT2 power-down	Controls power-down functionality of the OUT2 driver. 0 = OUT2 active (default). 1 = OUT2 powered down.
	[5:3]	OUT2 mode control	OUT2 driver mode selection. 000 = CMOS, both pins active. 001 = CMOS, positive pin active, negative pin tristate. 010 = CMOS, positive pin tristate, negative pin active. 011 = CMOS, both pins tristate. 100 = LVDS. 101 = LVPECL (default). 110 = not used. 111 = not used.
	[2:1]	OUT2 CMOS polarity	Selects the polarity of the OUT2 pins in CMOS mode. 00 = positive pin logic is true = 1, false = 0/negative pin logic is true = 0, false = 1 (default). 01 = positive pin logic is true = 1, false = 0/negative pin logic is true = 1, false = 0. 10 = positive pin logic is true = 0, false = 1/negative pin logic is true = 0, false = 1. 11 = positive pin logic is true = 0, false = 1/negative pin logic is true = 1, false = 0. These bits are ineffective unless Bits[5:3] select CMOS mode.
	0	Enable SPI control of OUT2 driver control	Controls OUT2 driver functionality. 0 = OUT2 is LVDS or LVPECL, per the OUTSEL pin (Pin 15) (default). 1 = OUT2 functionality defined by Bits[7:1].

OUTLINE DIMENSIONS

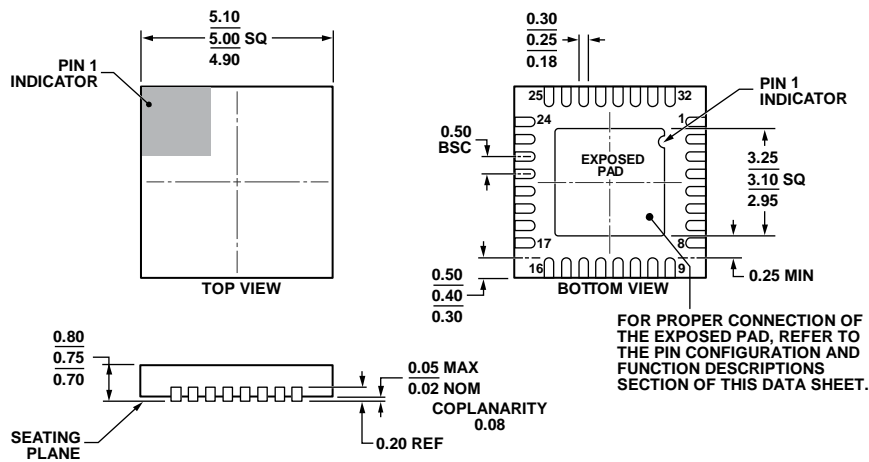

COMPLIANT TO JEDEC STANDARDS MO-220-WHHD.
 Figure 30. 32-Lead Lead Frame Chip Scale Package [LFCSP_WQ]
 5 mm × 5 mm Body, Very Very Thin Quad
 (CP-32-7)
 Dimensions shown in millimeters

112408-A

ORDERING GUIDE

Model ¹	Temperature Range	Package Description	Package Option
AD9552BCPZ	-40°C to +85°C	32-Lead Lead Frame Chip Scale Package [LFCSP_WQ]	CP-32-7
AD9552BCPZ-REEL7	-40°C to +85°C	32-Lead Lead Frame Chip Scale Package [LFCSP_WQ]	CP-32-7
AD9552/PCBZ		Evaluation Board	

¹ Z = RoHS Compliant Part.

NOTES

NOTES

Mouser Electronics

Authorized Distributor

Click to View Pricing, Inventory, Delivery & Lifecycle Information:

[Analog Devices Inc.:](#)

[AD9552/PCBZ](#) [AD9552BCPZ](#) [AD9552BCPZ-REEL7](#)