

AC Filter, Broad Band Attenuation



Approvals and Compliances

Description

- Line-filter in standard version
- 1-stage
- high attenuation

Characteristics

- Designed for high current applications
- High attenuation at maximum resp. asymmetric load independent from the line impedance
- Especially designed for industrial applications such as: Frequency Converters, Stepper Motor Drives, UPS-Systems, Inverters
- Suitable for use in equipment according to IEC/UL 60950

References

Alternative: Standard version

Weblinks

[pdf datasheet](#), [html-datasheet](#), [General Product Information](#), [Distributor-Stock-Check](#), [Detailed request for product](#), [Microsite](#)

Technical Data

Ratings IEC	12 - 50A @ Ta 40 °C / 250VAC; 50Hz
Ratings UL/CSA	12 - 50A @ Ta 40 °C / 125VAC; 60Hz
Leakage Current	industrial < 5.2mA (250V / 60Hz)
Dielectric Strength	> 1.7kVDC between L-N > 2.7kVDC between L/N-PE Test voltage (2 sec)
Allowable Operation Temperature	-25 °C to 100 °C
Climatic Category	25/100/21 acc. to IEC 60068-1
Protection Class	Suitable for appliances with protection class I acc. to IEC 61140
Terminal	Screw
Material: Housing	Metal

Line Filter	Industrial Version, IEC 60939, UL 1283, CSA C22.2 no. 8 Technical Details
MTBF	> 200'000h acc. to MIL-HB-217 F

Approvals and Compliances

Detailed information on product approvals, code requirements, usage instructions and detailed test conditions can be looked up in [Details about Approvals](#)

Approvals



The approval mark is used by the testing authorities to certify compliance with the safety requirements placed on electronic products.

Approval Reference Type: FMAB

Approval Logo	Certificates	Certification Body	Description
	VDE Approvals	VDE	Certificate Number: 40004673
	UL Approvals	UL	UL File Number: E72928

Product standards

Product standards that are referenced

Organization	Design	Standard	Description
	Designed according to	IEC 60939	Passive filters for suppressing electromagnetic interference
	Designed according to	UL 1283	Electromagnetic interference filters
	Designed according to	CSA C22.2 no. 8	Electromagnetic interference (EMI) filters





Application standards

Application standards where the product can be used

Organization	Design	Standard	Description
	Designed for applications acc.	IEC/UL 60950	IEC 60950-1 includes the basic requirements for the safety of information technology equipment.

Compliances

The product complies with following Guide Lines

Identification	Details	Initiator	Description
	CE declaration of conformity	SCHURTER AG	The CE marking declares that the product complies with the applicable requirements laid down in the harmonisation of Community legislation on its affixing in accordance with EU Regulation 765/2008.
	RoHS	SCHURTER AG	EU Directive RoHS 2011/65/EU
	China RoHS	SCHURTER AG	The law SJ / T 11363-2006 (China RoHS) has been in force since 1 March 2007. It is similar to the EU directive RoHS.
	REACH	SCHURTER AG	On 1 June 2007, Regulation (EC) No 1907/2006 on the Registration, Evaluation, Authorization and Restriction of Chemicals 1 (abbreviated as "REACH") entered into force.

Dimension [mm]

Case 24-2

Case 24-6

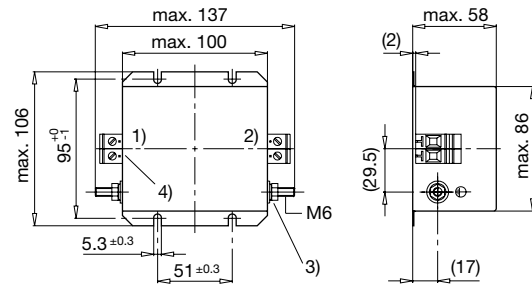
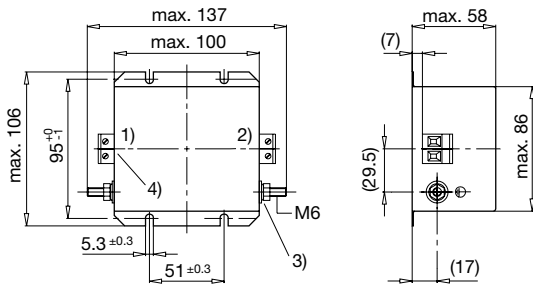

- 1) Line
- 2) Load
- 3) Nut torque 3...4 Nm
- 4) I/O Connections torque 0.6...0.8

- 1) Line
- 2) Load
- 3) Nut torque 3...4 Nm
- 4) I/O Connections torque 1.5...1.8

Case 79-2

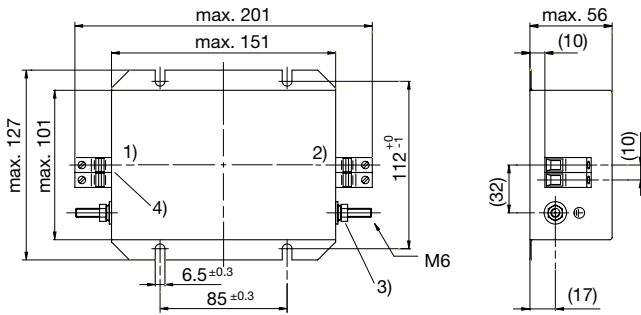

- 1) Line
- 2) Load
- 3) Nut torque 3...4 Nm
- 4) I/O Connections torque 1.5...1.8

Diagrams

Standard version

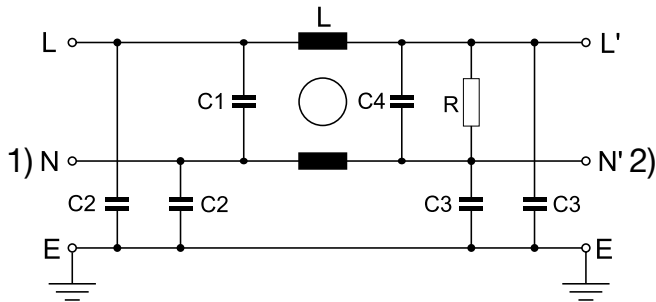

- 1) Line
- 2) Load

Attenuation Loss

----- 50Ω differential mode _____ 50Ω common mode

Industrial version

12 A

20 A

30 A

50 A

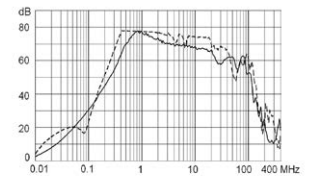
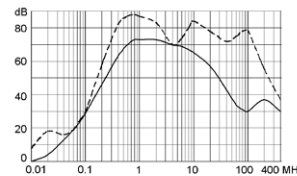
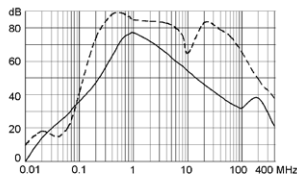
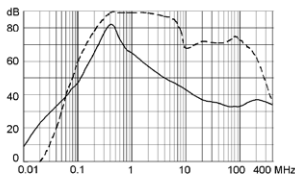

All Variants

Rated Current [A]	Filter-Type	Leakage Current [mA]	L [mH]	C1 (X2)	C2 (Y2) [nF]	C3 (Y2)	C4 (X2)	R [MΩ]	Clamps [mm ²]	Weight [g]	Housings	Order Number
12	Industrial Version	5.2	2 x 10	2.2	10	47	1	1	4	927 g	24-2	5500.2064
20	Industrial Version	5.2	2 x 3.5	2.2	10	47	1	1	4	930 g	24-2	5500.2065
30	Industrial Version	5.6	2 x 1.5	2.2	15	47	1	1	6	970 g	24-6	5500.2066
50	Industrial Version	5.6	2 x 1.5	2.2	15	47	1	1	10	970 g	79-2	5500.2067

Most Popular.

Availability for all products can be searched real-time: <https://www.schurter.com/en/Stock-Check/Stock-Check-SCHURTER>

Packaging unit 2 Pcs

Mouser Electronics

Authorized Distributor

Click to View Pricing, Inventory, Delivery & Lifecycle Information:

Schurter:

[5500.2064](#) [5500.2066](#) [5500.2065](#) [5500.2630.01](#) [5500.2630.04](#) [5500.2631.01](#) [5500.2632.01](#) [5500.2633.01](#)
[5500.2634.01](#) [5500.2635.01](#) [5500.2636.01](#) [5500.2637.01](#) [5500.2638.01](#) [5500.2639.03](#) [5500.2630.07](#) [5500.2650.01](#)
[5500.2642.01](#) [5500.2644.01](#) [5500.2655.01](#) [5500.2634.07](#) [5500.2658.03](#) [5500.2656.07](#) [5500.2657.03](#)
[5500.2637.04](#) [5500.2640.07](#) [5500.2643.01](#) [5500.2653.04](#) [5500.2651.07](#) [5500.2657.09](#) [5500.2648.09](#) [5500.2643.04](#)
[5500.2646.01](#) [5500.2647.03](#) [5500.2633.07](#) [5500.2634.04](#) [5500.2654.04](#) [5500.2639.06](#) [5500.2639.09](#)
[5500.2646.07](#) [5500.2636.07](#) [5500.2651.01](#) [5500.2633.04](#) [5500.2640.04](#) [5500.2631.04](#) [5500.2647.09](#) [5500.2641.01](#)
[5500.2648.06](#) [5500.2648.03](#) [5500.2650.04](#) [5500.2656.01](#) [5500.2631.07](#) [5500.2638.07](#) [5500.2642.04](#)
[5500.2643.07](#) [5500.2644.07](#) [5500.2644.04](#) [5500.2638.04](#) [5500.2658.09](#) [5500.2647.06](#) [5500.2651.04](#) [5500.2653.07](#)
[5500.2655.04](#) [5500.2653.01](#) [5500.2632.07](#) [5500.2645.04](#) [5500.2636.04](#) [5500.2652.07](#) [5500.2642.07](#)
[5500.2650.07](#) [5500.2652.01](#) [5500.2658.06](#) [5500.2632.04](#) [5500.2640.01](#) [5500.2641.07](#) [5500.2646.04](#) [5500.2654.01](#)
[5500.2654.07](#) [5500.2657.06](#) [5500.2637.07](#) [5500.2635.04](#) [5500.2641.04](#) [5500.2652.04](#) [5500.2635.07](#)
[5500.2655.07](#) [5500.2656.04](#) [5500.2645.01](#) [5500.2645.07](#)