

74ALVC00

Quad 2-input NAND gate

Rev. 3 — 16 May 2014

Product data sheet

1. General description

The 74ALVC00 is a quad 2-input NAND gate.

Schmitt trigger action on all inputs makes the device tolerant of slow rise and fall times.

2. Features and benefits

- Wide supply voltage range from 1.65 V to 3.6 V
- 3.6 V tolerant inputs/outputs
- CMOS low power consumption
- Direct interface with TTL levels (2.7 V to 3.6 V)
- Power-down mode
- Latch-up performance exceeds 250 mA
- Complies with JEDEC standards:
 - ◆ JESD8-7 (1.65 V to 1.95 V)
 - ◆ JESD8-5 (2.3 V to 2.7 V)
 - ◆ JESD8B/JESD36 (2.7 V to 3.6 V)
- ESD protection:
 - ◆ HBM JESD22-A114E exceeds 2000 V
 - ◆ MM JESD22-A115-A exceeds 200 V

3. Ordering information

Table 1. Ordering information

Type number	Package			
	Temperature range	Name	Description	Version
74ALVC00D	−40 °C to +85 °C	SO14	plastic small outline package; 14 leads; body width 3.9 mm	SOT108-1
74ALVC00PW	−40 °C to +85 °C	TSSOP14	plastic thin shrink small outline package; 14 leads; body width 4.4 mm	SOT402-1
74ALVC00BQ	−40 °C to +85 °C	DHVQFN14	plastic dual in-line compatible thermal enhanced very thin quad flat package; no leads; 14 terminals; body 2.5 × 3 × 0.85 mm	SOT762-1

4. Functional diagram

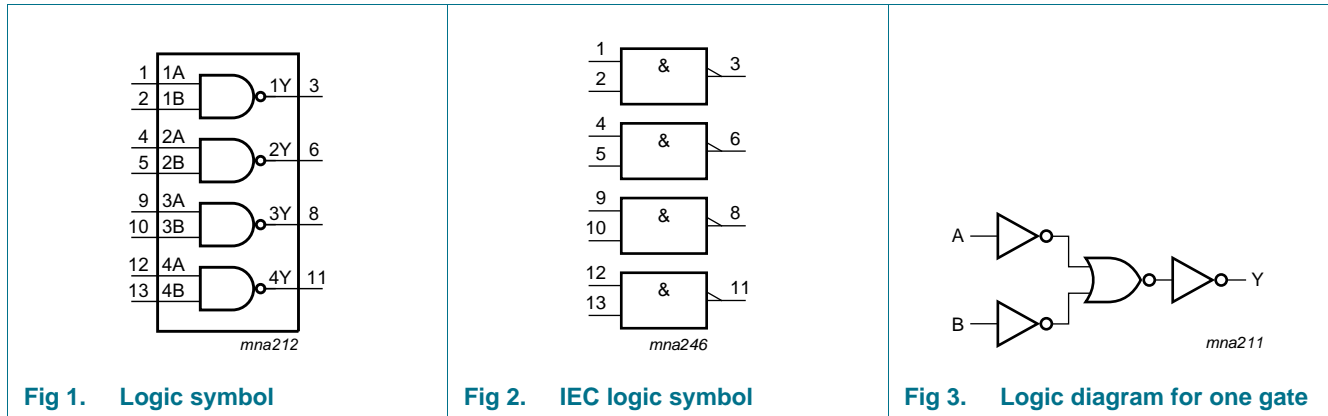

5. Pinning information

5.1 Pinning

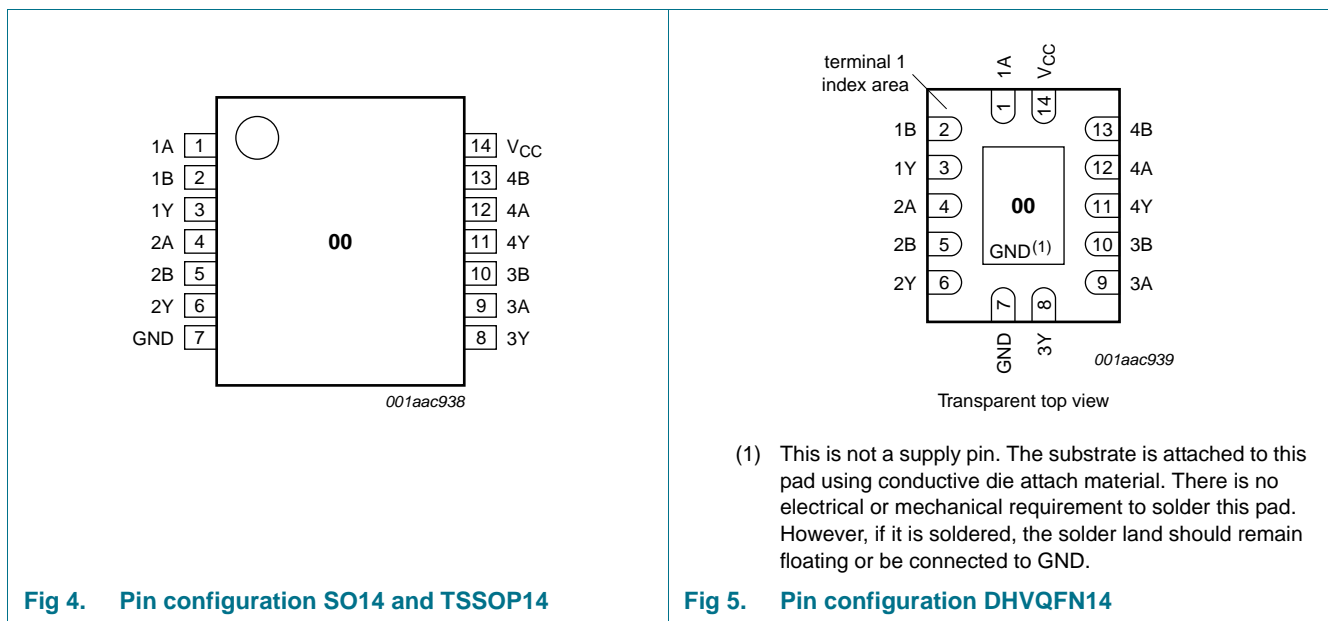

5.2 Pin description

Table 2. Pin description

Symbol	Pin	Description
1A to 4A	1, 4, 9, 12	data input
1B to 4B	2, 5, 10, 13	data input
1Y to 4Y	3, 6, 8, 11	data output
GND	7	ground (0 V)
V _{CC}	14	supply voltage

6. Functional description

Table 3. Function selection^[1]

Input		Output
nA	nB	nY
L	X	H
X	L	H
H	H	L

[1] H = HIGH voltage level; L = LOW voltage level; X = don't care

7. Limiting values

Table 4. Limiting values

In accordance with the Absolute Maximum Rating System (IEC 60134). Voltages are referenced to GND (ground = 0 V).

Symbol	Parameter	Conditions	Min	Max	Unit
V_{CC}	supply voltage		-0.5	+4.6	V
I_{IK}	input clamping current	$V_I < 0$ V	-50	-	mA
V_I	input voltage		-0.5	+4.6	V
I_{OK}	output clamping current	$V_O > V_{CC}$ or $V_O < 0$ V	-	± 50	mA
V_O	output voltage	output HIGH or LOW state ^{[1] [2]}	-0.5	$V_{CC} + 0.5$	V
		output 3-state	-0.5	+4.6	V
		power-down mode, $V_{CC} = 0$ V ^[2]	-0.5	+4.6	V
I_O	output current	$V_O = 0$ V to V_{CC}	-	± 50	mA
I_{CC}	supply current		-	100	mA
I_{GND}	ground current		-100	-	mA
T_{stg}	storage temperature		-65	+150	°C
P_{tot}	total power dissipation	$T_{amb} = -40$ °C to +85 °C ^[3]	-	500	mW

[1] The input and output voltage ratings may be exceeded if the input and output current ratings are observed.

[2] When $V_{CC} = 0$ V (power-down mode), the output voltage can be 3.6 V in normal operation.

[3] For SO14 packages: above 70 °C derate linearly with 8 mW/K.
 For TSSOP14 packages: above 60 °C derate linearly with 5.5 mW/K.
 For DHVQFN14 packages: above 60 °C derate linearly with 4.5 mW/K.

8. Recommended operating conditions

Table 5. Recommended operating conditions

Symbol	Parameter	Conditions	Min	Max	Unit
V_{CC}	supply voltage		1.65	3.6	V
V_I	input voltage		0	3.6	V
V_O	output voltage	output HIGH or LOW state	0	V_{CC}	V
		output 3-state	0	3.6	V
		power-down mode; $V_{CC} = 0$ V	0	3.6	V
T_{amb}	ambient temperature	in free air	-40	+85	°C
$\Delta t/\Delta V$	input transition rise and fall rate	$V_{CC} = 1.65$ V to 2.7 V	0	20	ns/V
		$V_{CC} = 2.7$ V to 3.6 V	0	10	ns/V

9. Static characteristics

Table 6. Static characteristics

At recommended operating conditions. Voltages are referenced to GND (ground = 0 V).

Symbol	Parameter	Conditions	$T_{amb} = -40$ °C to +85 °C			Unit
			Min	Typ ^[1]	Max	
V_{IH}	HIGH-level input voltage	$V_{CC} = 1.65$ V to 1.95 V	$0.65 \times V_{CC}$	-	-	V
		$V_{CC} = 2.3$ V to 2.7 V	1.7	-	-	V
		$V_{CC} = 2.7$ V to 3.6 V	2.0	-	-	V
V_{IL}	LOW-level input voltage	$V_{CC} = 1.65$ V to 1.95 V	-	-	$0.35 \times V_{CC}$	V
		$V_{CC} = 2.3$ V to 2.7 V	-	-	0.7	V
		$V_{CC} = 2.7$ V to 3.6 V	-	-	0.8	V
V_{OH}	HIGH-level output voltage	$V_I = V_{IH}$ or V_{IL}				
		$I_O = -100$ μ A; $V_{CC} = 1.65$ V to 3.6 V	$V_{CC} - 0.2$	-	-	V
		$I_O = -6$ mA; $V_{CC} = 1.65$ V	1.25	1.51	-	V
		$I_O = -12$ mA; $V_{CC} = 2.3$ V	1.8	2.10	-	V
		$I_O = -18$ mA; $V_{CC} = 2.3$ V	1.7	2.01	-	V
		$I_O = -12$ mA; $V_{CC} = 2.7$ V	2.2	2.53	-	V
		$I_O = -18$ mA; $V_{CC} = 3.0$ V	2.4	2.76	-	V
V_{OL}	LOW-level output voltage	$V_I = V_{IH}$ or V_{IL}				
		$I_O = 100$ μ A; $V_{CC} = 1.65$ V to 3.6 V	-	-	0.2	V
		$I_O = 6$ mA; $V_{CC} = 1.65$ V	-	0.11	0.3	V
		$I_O = 12$ mA; $V_{CC} = 2.3$ V	-	0.17	0.4	V
		$I_O = 18$ mA; $V_{CC} = 2.3$ V	-	0.25	0.6	V
		$I_O = 12$ mA; $V_{CC} = 2.7$ V	-	0.16	0.4	V
		$I_O = 18$ mA; $V_{CC} = 3.0$ V	-	0.23	0.4	V
I_I	input leakage current	$V_{CC} = 3.6$ V; $V_I = 3.6$ V or GND	-	± 0.1	± 5	μ A
		$V_{CC} = 0$ V; V_I or $V_O = 0$ V to 3.6 V	-	± 0.1	± 10	μ A
I_{OFF}	power-off leakage current	$V_{CC} = 0$ V; V_I or $V_O = 0$ V to 3.6 V	-	± 0.1	± 10	μ A

Table 6. Static characteristics ...continued

At recommended operating conditions. Voltages are referenced to GND (ground = 0 V).

Symbol	Parameter	Conditions	T _{amb} = -40 °C to +85 °C			Unit
			Min	Typ ^[1]	Max	
I _{CC}	supply current	V _{CC} = 3.6 V; V _I = V _{CC} or GND; I _O = 0 A	-	0.2	20	μA
ΔI _{CC}	additional supply current	per input pin; V _{CC} = 3.0 V to 3.6 V; V _I = V _{CC} - 0.6 V; I _O = 0 A	-	5	750	μA
C _I	input capacitance		-	3.5	-	pF

[1] All typical values are measured at V_{CC} = 3.3 V (unless stated otherwise) and T_{amb} = 25 °C.

10. Dynamic characteristics

Table 7. Dynamic characteristicsVoltages are referenced to GND (ground = 0 V). For test circuit, see [Figure 7](#).

Symbol	Parameter	Conditions	T _{amb} = -40 °C to +85 °C			Unit
			Min	Typ ^[1]	Max	
t _{pd}	propagation delay	nA, nB to nY; see Figure 6 ^[2]				
		V _{CC} = 1.65 V to 1.95 V	1.0	2.8	4.4	ns
		V _{CC} = 2.3 V to 2.7 V	1.0	2.1	2.8	ns
		V _{CC} = 2.7 V	1.0	2.6	3.2	ns
		V _{CC} = 3.0 V to 3.6 V	1.0	2.1	3.0	ns
C _{PD}	power dissipation capacitance	per gate; V _I = GND to V _{CC} ; V _{CC} = 3.3 V ^[3]	-	28	-	pF

[1] Typical values are measured at T_{amb} = 25 °C[2] t_{pd} is the same as t_{PHL} and t_{PLH}.[3] C_{PD} is used to determine the dynamic power dissipation (P_D in μW).

$$P_D = C_{PD} \times V_{CC}^2 \times f_i \times N + \Sigma(C_L \times V_{CC}^2 \times f_o) \text{ where:}$$

f_i = input frequency in MHz; f_o = output frequency in MHzC_L = output load capacitance in pFV_{CC} = supply voltage in Volts

N = number of inputs switching

Σ(C_L × V_{CC}² × f_o) = sum of the outputs

11. Waveforms

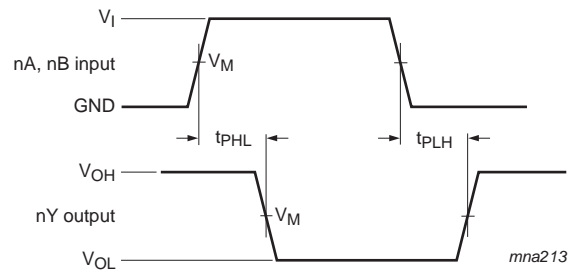

Measurement points are given in [Table 8](#).

Fig 6. Inputs nA, nB to output nY propagation delay times

Table 8. Measurement points

Supply voltage V_{CC}	Input V_I	V_M
1.65 V to 1.95 V	V_{CC}	$0.5V_{CC}$
2.3 V to 2.7 V	V_{CC}	$0.5V_{CC}$
2.7 V	2.7 V	1.5 V
3.0 V to 3.6 V	2.7 V	1.5 V

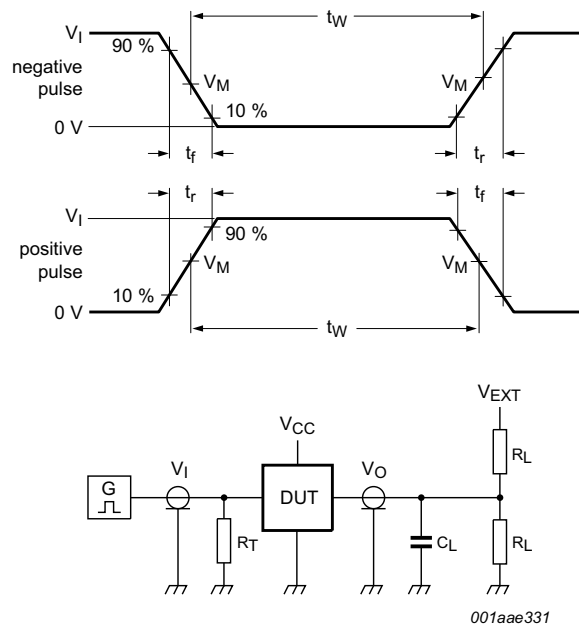

Test data is given in [Table 9](#).

Definitions for test circuit:

R_L = Load resistance.

C_L = Load capacitance including jig and probe capacitance.

R_T = Termination resistance should be equal to output impedance Z_o of the pulse generator.

V_{EXT} = External voltage for measuring switching times.

Fig 7. Test circuit for measuring switching times

Table 9. Test data

Supply voltage V_{CC}	Input		Load		V_{EXT}		
	V_I	t_r, t_f	C_L	R_L	t_{PLH}, t_{PHL}	t_{PLZ}, t_{PZL}	t_{PHZ}, t_{PZH}
1.65 V to 1.95 V	V_{CC}	≤ 2.0 ns	30 pF	1 k Ω	open	$2 \times V_{CC}$	GND
2.3 V to 2.7 V	V_{CC}	≤ 2.0 ns	30 pF	500 Ω	open	$2 \times V_{CC}$	GND
2.7 V	2.7 V	≤ 2.5 ns	50 pF	500 Ω	open	6 V	GND
3.0 V to 3.6 V	2.7 V	≤ 2.5 ns	50 pF	500 Ω	open	6 V	GND

12. Package outline

SO14: plastic small outline package; 14 leads; body width 3.9 mm

SOT108-1

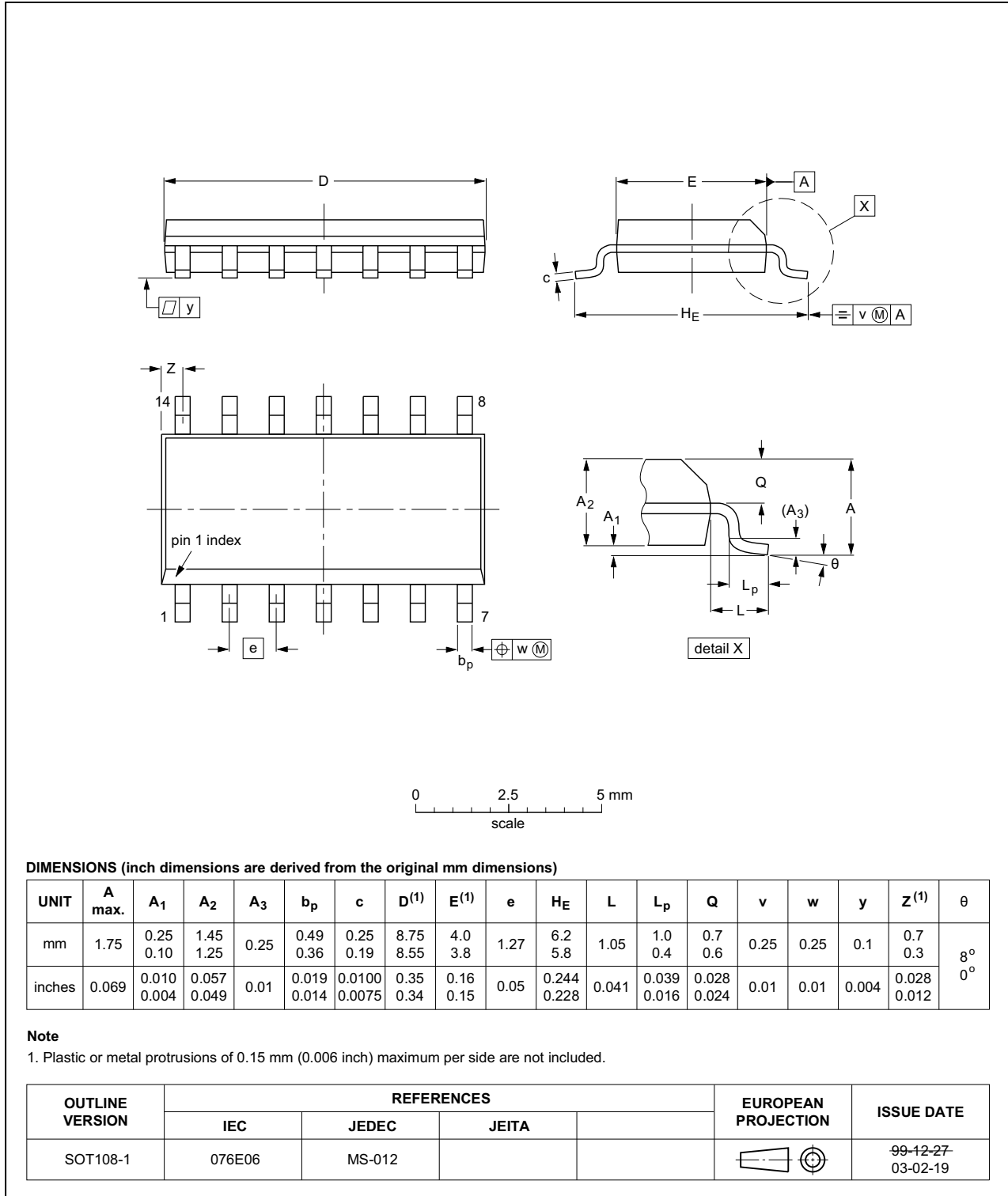

Fig 8. Package outline SOT108-1 (SO14)

TSSOP14: plastic thin shrink small outline package; 14 leads; body width 4.4 mm

SOT402-1

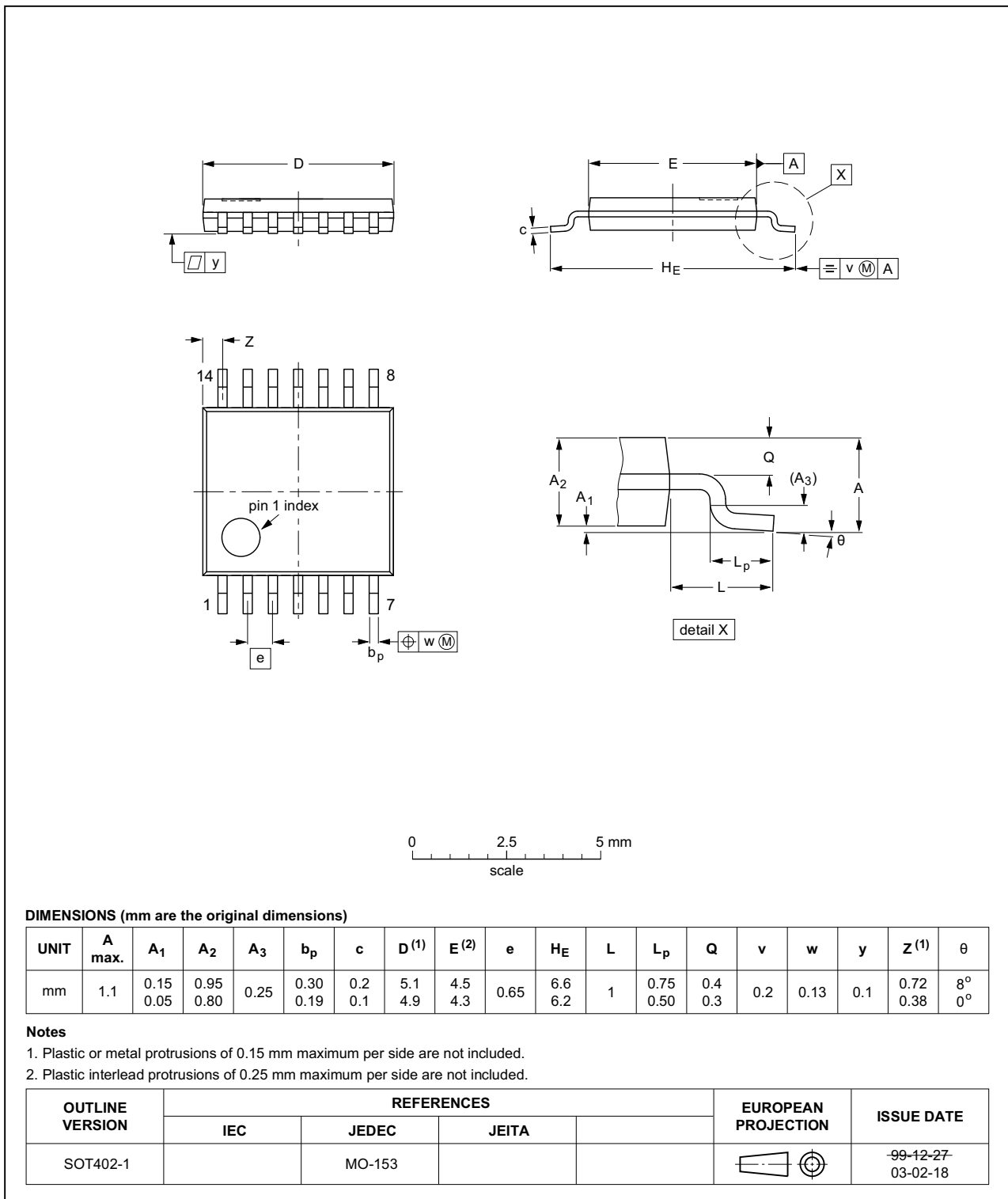

Fig 9. Package outline SOT402-1 (TSSOP14)

DHVQFN14: plastic dual in-line compatible thermal enhanced very thin quad flat package; no leads; 14 terminals; body 2.5 x 3 x 0.85 mm

SOT762-1

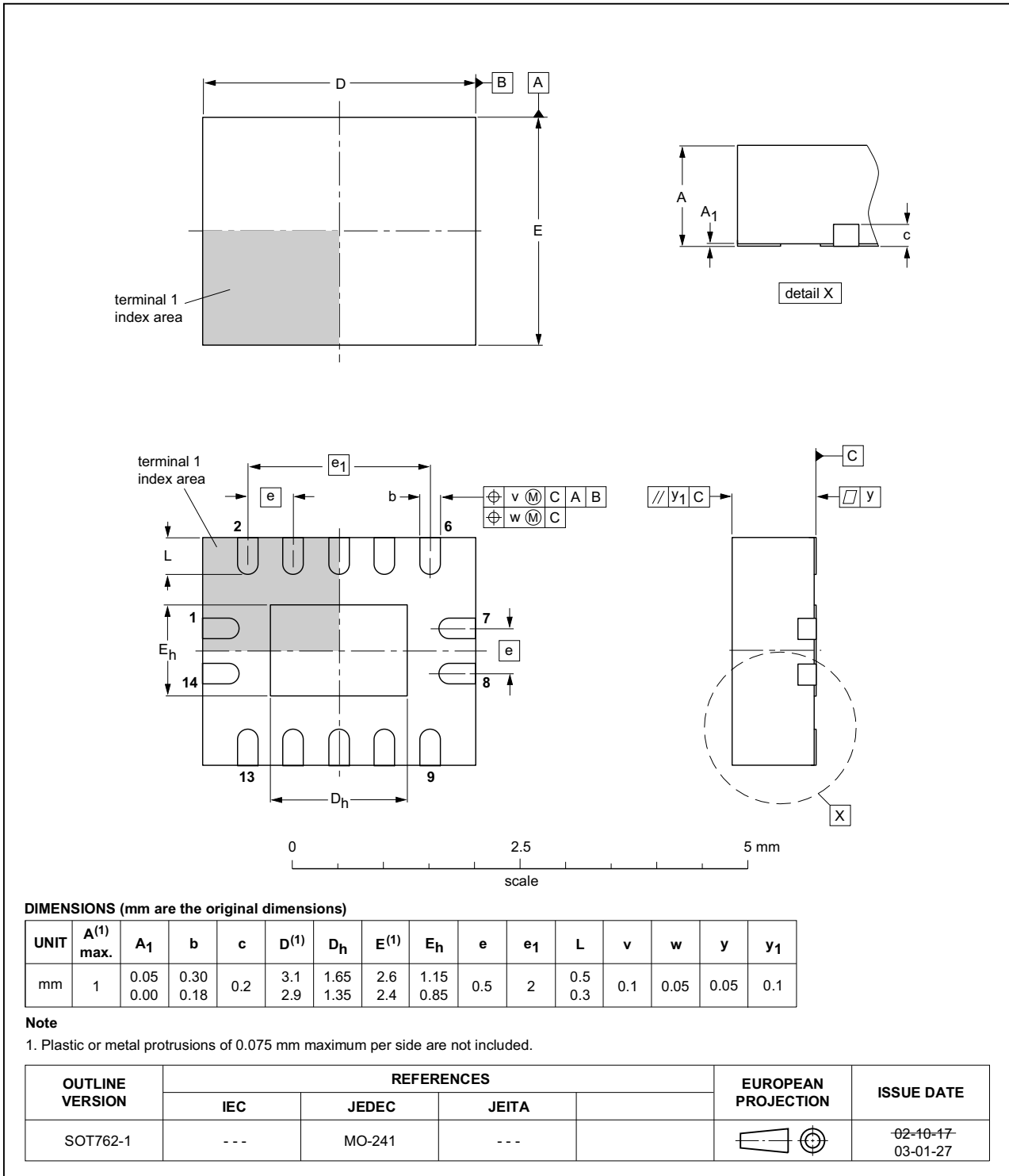

Fig 10. Package outline SOT762-1 (DHVQFN14)

13. Abbreviations

Table 10. Abbreviations

Acronym	Description
CDM	Charged Device Model
DUT	Device Under Test
ESD	ElectroStatic Discharge
HBM	Human Body Model
MM	Machine Model
TTL	Transistor-Transistor Logic

14. Revision history

Table 11. Revision history

Document ID	Release date	Data sheet status	Change notice	Supersedes
74ALVC00 v.3	20140516	Product data sheet	-	74ALVC00 v.2
	<ul style="list-style-type: none">The format of this data sheet has been redesigned to comply with the new identity guidelines of NXP Semiconductors.Legal texts have been adapted to the new company name where appropriate.			
74ALVC00 v.2	20030514	Product specification	-	74ALVC00 v.1
74ALVC00 v.1	20030206	Product specification	-	-

15. Legal information

15.1 Data sheet status

Document status ^{[1][2]}	Product status ^[3]	Definition
Objective [short] data sheet	Development	This document contains data from the objective specification for product development.
Preliminary [short] data sheet	Qualification	This document contains data from the preliminary specification.
Product [short] data sheet	Production	This document contains the product specification.

[1] Please consult the most recently issued document before initiating or completing a design.

[2] The term 'short data sheet' is explained in section "Definitions".

[3] The product status of device(s) described in this document may have changed since this document was published and may differ in case of multiple devices. The latest product status information is available on the Internet at URL <http://www.nexperia.com>.

15.2 Definitions

Draft — The document is a draft version only. The content is still under internal review and subject to formal approval, which may result in modifications or additions. Nexperia does not give any representations or warranties as to the accuracy or completeness of information included herein and shall have no liability for the consequences of use of such information.

Short data sheet — A short data sheet is an extract from a full data sheet with the same product type number(s) and title. A short data sheet is intended for quick reference only and should not be relied upon to contain detailed and full information. For detailed and full information see the relevant full data sheet, which is available on request via the local Nexperia sales office. In case of any inconsistency or conflict with the short data sheet, the full data sheet shall prevail.

Product specification — The information and data provided in a Product data sheet shall define the specification of the product as agreed between Nexperia and its customer, unless Nexperia and customer have explicitly agreed otherwise in writing. In no event however, shall an agreement be valid in which the Nexperia product is deemed to offer functions and qualities beyond those described in the Product data sheet.

15.3 Disclaimers

Limited warranty and liability — Information in this document is believed to be accurate and reliable. However, Nexperia does not give any representations or warranties, expressed or implied, as to the accuracy or completeness of such information and shall have no liability for the consequences of use of such information. Nexperia takes no responsibility for the content in this document if provided by an information source outside of Nexperia.

In no event shall Nexperia be liable for any indirect, incidental, punitive, special or consequential damages (including - without limitation - lost profits, lost savings, business interruption, costs related to the removal or replacement of any products or rework charges) whether or not such damages are based on tort (including negligence), warranty, breach of contract or any other legal theory.

Notwithstanding any damages that customer might incur for any reason whatsoever, Nexperia's aggregate and cumulative liability towards customer for the products described herein shall be limited in accordance with the *Terms and conditions of commercial sale* of Nexperia.

Right to make changes — Nexperia reserves the right to make changes to information published in this document, including without limitation specifications and product descriptions, at any time and without notice. This document supersedes and replaces all information supplied prior to the publication hereof.

Suitability for use — Nexperia products are not designed, authorized or warranted to be suitable for use in life support, life-critical or safety-critical systems or equipment, nor in applications where failure or malfunction of a Nexperia product can reasonably be expected to result in personal injury, death or severe property or environmental damage. Nexperia and its suppliers accept no liability for inclusion and/or use of Nexperia products in such equipment or applications and therefore such inclusion and/or use is at the customer's own risk.

Applications — Applications that are described herein for any of these products are for illustrative purposes only. Nexperia makes no representation or warranty that such applications will be suitable for the specified use without further testing or modification.

Customers are responsible for the design and operation of their applications and products using Nexperia products, and Nexperia accepts no liability for any assistance with applications or customer product design. It is customer's sole responsibility to determine whether the Nexperia product is suitable and fit for the customer's applications and products planned, as well as for the planned application and use of customer's third party customer(s). Customers should provide appropriate design and operating safeguards to minimize the risks associated with their applications and products.

Nexperia does not accept any liability related to any default, damage, costs or problem which is based on any weakness or default in the customer's applications or products, or the application or use by customer's third party customer(s). Customer is responsible for doing all necessary testing for the customer's applications and products using Nexperia products in order to avoid a default of the applications and the products or of the application or use by customer's third party customer(s). Nexperia does not accept any liability in this respect.

Limiting values — Stress above one or more limiting values (as defined in the Absolute Maximum Ratings System of IEC 60134) will cause permanent damage to the device. Limiting values are stress ratings only and (proper) operation of the device at these or any other conditions above those given in the Recommended operating conditions section (if present) or the Characteristics sections of this document is not warranted. Constant or repeated exposure to limiting values will permanently and irreversibly affect the quality and reliability of the device.

Terms and conditions of commercial sale — Nexperia products are sold subject to the general terms and conditions of commercial sale, as published at <http://www.nexperia.com/profile/terms>, unless otherwise agreed in a valid written individual agreement. In case an individual agreement is concluded only the terms and conditions of the respective agreement shall apply. Nexperia hereby expressly objects to applying the customer's general terms and conditions with regard to the purchase of Nexperia products by customer.

No offer to sell or license — Nothing in this document may be interpreted or construed as an offer to sell products that is open for acceptance or the grant, conveyance or implication of any license under any copyrights, patents or other industrial or intellectual property rights.

Export control — This document as well as the item(s) described herein may be subject to export control regulations. Export might require a prior authorization from competent authorities.

Non-automotive qualified products — Unless this data sheet expressly states that this specific Nexperia product is automotive qualified, the product is not suitable for automotive use. It is neither qualified nor tested in accordance with automotive testing or application requirements. Nexperia accepts no liability for inclusion and/or use of non-automotive qualified products in automotive equipment or applications.

In the event that customer uses the product for design-in and use in automotive applications to automotive specifications and standards, customer (a) shall use the product without Nexperia's warranty of the product for such automotive applications, use and specifications, and (b) whenever customer uses the product for automotive applications beyond

Nexperia's specifications such use shall be solely at customer's own risk, and (c) customer fully indemnifies Nexperia for any liability, damages or failed product claims resulting from customer design and use of the product for automotive applications beyond Nexperia's standard warranty and Nexperia's product specifications.

Translations — A non-English (translated) version of a document is for reference only. The English version shall prevail in case of any discrepancy between the translated and English versions.

15.4 Trademarks

Notice: All referenced brands, product names, service names and trademarks are the property of their respective owners.

16. Contact information

For more information, please visit: <http://www.nexperia.com>

For sales office addresses, please send an email to: salesaddresses@nexperia.com

17. Contents

1	General description	1
2	Features and benefits	1
3	Ordering information	1
4	Functional diagram	2
5	Pinning information	2
5.1	Pinning	2
5.2	Pin description	2
6	Functional description	3
7	Limiting values	3
8	Recommended operating conditions	4
9	Static characteristics	4
10	Dynamic characteristics	5
11	Waveforms	6
12	Package outline	8
13	Abbreviations	11
14	Revision history	11
15	Legal information	12
15.1	Data sheet status	12
15.2	Definitions	12
15.3	Disclaimers	12
15.4	Trademarks	13
16	Contact information	13
17	Contents	14