

0.4-GHz TO 4-GHz QUADRATURE MODULATOR

Check for Samples: [TRF370317](#)

FEATURES

- 76-dBc Single-Carrier WCDMA ACPR at –8 dBm Channel Power
- Low Noise Floor: –163 dBm/Hz
- OIP3 of 26.5 dBm
- P1dB of 12 dBm
- Unadjusted Carrier Feedthrough of –40 dBm
- Unadjusted Side-Band Suppression of –45 dBc
- Single Supply: 4.5-V–5.5-V Operation
- Silicon Germanium Technology
- 1.7-V CM at I, Q Baseband Inputs

APPLICATIONS

- Cellular Base Station Transceiver
- CDMA: IS95, UMTS, CDMA2000, TD-SCDMA
- TDMA: GSM, IS-136, EDGE/UWC-136
- Multicarrier GSM
- WiMAX: 802.16d/e
- 3GPP: LTE
- Wireless MAN Wideband Transceivers

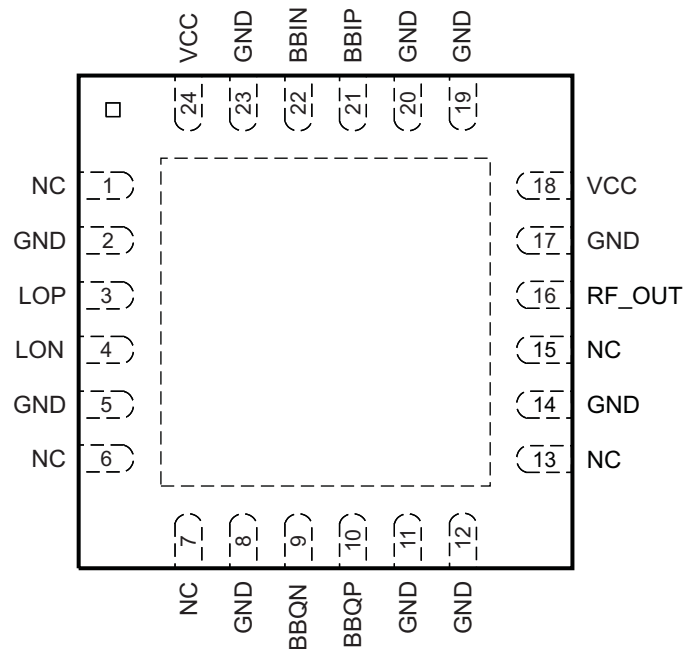
RGE PACKAGE
(TOP VIEW)

P0024-04

DESCRIPTION

The TRF370317 is a low-noise direct quadrature modulator, capable of converting complex modulated signals from baseband or IF directly up to RF. The TRF370317 is a high-performance, superior-linearity device that is ideal to RF frequencies of 400 MHz through 4 GHz. The modulator is implemented as a double-balanced mixer. The RF output block consists of a differential to single-ended converter and an RF amplifier capable of driving a single-ended 50-Ω load without any need of external components. The TRF370317 requires a 1.7-V common-mode voltage for optimum linearity performance.



Please be aware that an important notice concerning availability, standard warranty, and use in critical applications of Texas Instruments semiconductor products and disclaimers thereto appears at the end of this data sheet.

All trademarks are the property of their respective owners.



This integrated circuit can be damaged by ESD. Texas Instruments recommends that all integrated circuits be handled with appropriate precautions. Failure to observe proper handling and installation procedures can cause damage.

ESD damage can range from subtle performance degradation to complete device failure. Precision integrated circuits may be more susceptible to damage because very small parametric changes could cause the device not to meet its published specifications.

Functional Block Diagram

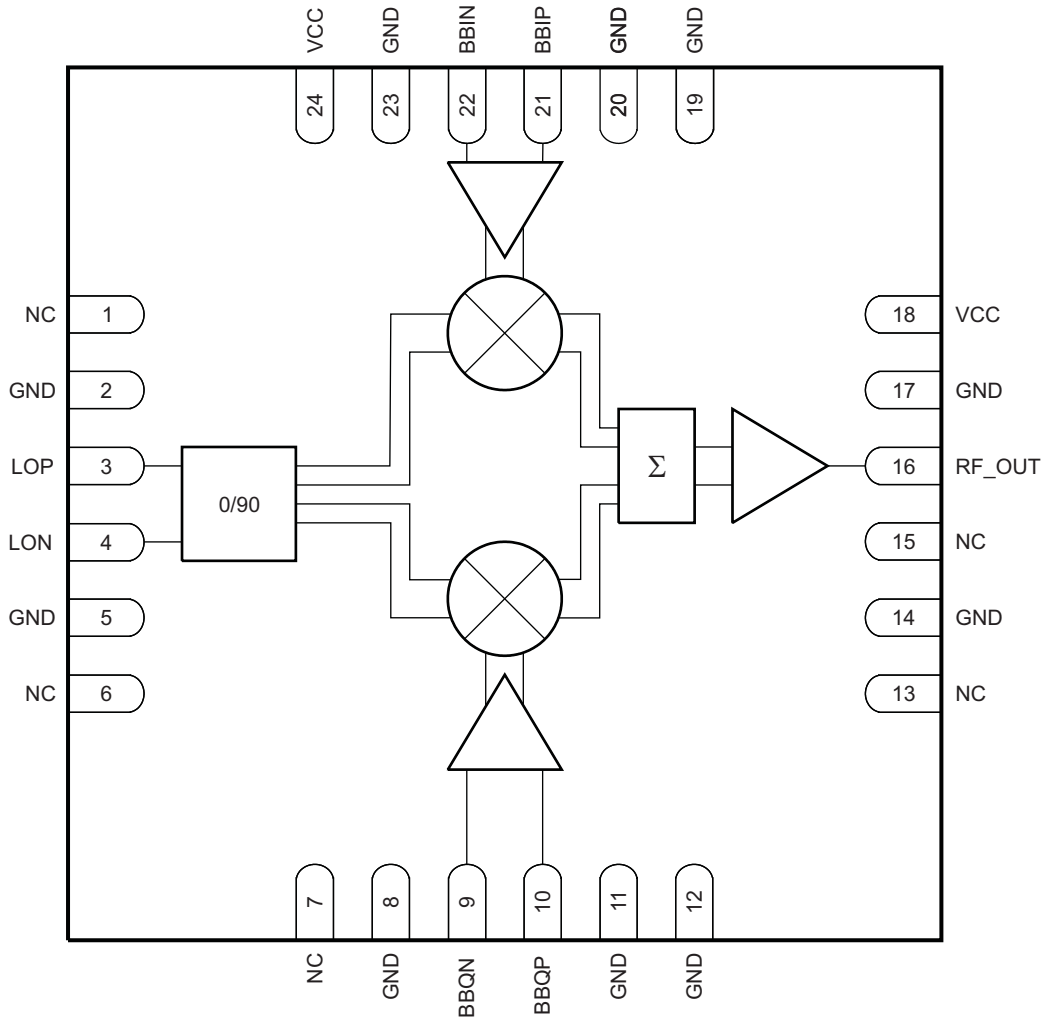

B0175-01

NOTE: NC = No connection

DEVICE INFORMATION

TERMINAL FUNCTIONS

TERMINAL		I/O	DESCRIPTION
NAME	NO.		
BBIN	22	I	In-phase negative input
BBIP	21	I	In-phase positive input
BBQN	9	I	Quadrature-phase negative input
BBQP	10	I	Quadrature-phase positive input
GND	2, 5, 8, 11, 12, 14, 17, 19, 20, 23	–	Ground
LON	4	I	Local oscillator negative input
LOP	3	I	Local oscillator positive input
NC	1, 6, 7, 13, 15	–	No connect
RF_OUT	16	O	RF output
VCC	18, 24	–	Power supply

ABSOLUTE MAXIMUM RATINGS⁽¹⁾

over operating free-air temperature range (unless otherwise noted)

		VALUE ⁽²⁾	UNIT	
Supply voltage range		–0.3 V to 6	V	
T _J	Operating virtual junction temperature range	–40 to 150	°C	
T _A	Operating ambient temperature range	–40 to 85	°C	
T _{stg}	Storage temperature range	–65 to 150	°C	
ESD	Electrostatic discharge ratings	Human body model (HBM)	75	V
		Charged device model (CDM)	75	V

(1) Stresses beyond those listed under *Absolute Maximum Ratings* may cause permanent damage to the device. These are stress ratings only, and functional operation of the device at these or any other conditions beyond those indicated under *Recommended Operating Conditions* is not implied. Exposure to absolute-maximum-rated conditions for extended periods may affect device reliability.

(2) All voltage values are with respect to network ground terminal.

RECOMMENDED OPERATING CONDITIONS

over operating free-air temperature range (unless otherwise noted)

		MIN	NOM	MAX	UNIT
V _{CC}	Power-supply voltage	4.5	5	5.5	V

THERMAL CHARACTERISTICS

PARAMETER	TEST CONDITIONS	VALUE	UNIT
R _{θJA}	Thermal resistance, junction-to-ambient High-K board, still air	29.4	°C/W
R _{θJC}	Thermal resistance, junction-to-case	18.6	°C/W

ELECTRICAL CHARACTERISTICS

over operating free-air temperature range (unless otherwise noted)

PARAMETER		TEST CONDITIONS	MIN	TYP	MAX	UNIT
DC Parameters						
I_{CC}	Total supply current (1.7 V CM)	$T_A = 25^\circ\text{C}$		205	245	mA
LO Input (50-Ω, Single-Ended)						
f_{LO}	LO frequency range		0.4		4	GHz
	LO input power		-5	0	12	dBm
	LO port return loss			15		dB
Baseband Inputs						
V_{CM}	I and Q input dc common voltage			1.7		
BW	1-dB input frequency bandwidth		350			MHz
$Z_{I(\text{single ended})}$	Input impedance, resistance			5		k Ω
	Input impedance, parallel capacitance			3		pF

ELECTRICAL CHARACTERISTICS

over recommended operating conditions, power supply = 5 V, $T_A = 25^\circ\text{C}$, $V_{CM} = 1.7$ V, $f_{LO} = 400$ MHz at 8 dBm, $V_{inBB} = 98$ mVrms single-ended in quadrature, $f_{BB} = 50$ kHz (unless otherwise noted)

RF Output Parameters						
PARAMETER		TEST CONDITIONS	MIN	TYP	MAX	UNIT
G	Voltage gain	Output rms voltage over input I (or Q) rms voltage		-1.9		dB
P1dB	Output compression point			11		dBm
IP3	Output IP3	$f_{BB} = 4.5, 5.5$ MHz		24.5		dBm
IP2	Output IP2	$f_{BB} = 4.5, 5.5$ MHz		68		dBm
	Carrier feedthrough	Unadjusted		-38		dBm
	Sideband suppression	Unadjusted		-40		dBc

ELECTRICAL CHARACTERISTICS

over recommended operating conditions, power supply = 5 V, $T_A = 25^\circ\text{C}$, $V_{CM} = 1.7\text{ V}$, $f_{LO} = 945.6\text{ MHz}$ at 8 dBm, $V_{inBB} = 98\text{ mVrms}$ single-ended in quadrature, $f_{BB} = 50\text{ kHz}$ (unless otherwise noted)

RF Output Parameters						
	PARAMETER	TEST CONDITIONS	MIN	TYP	MAX	UNIT
G	Voltage gain	Output rms voltage over input I (or Q) rms voltage		-2.5		dB
P1dB	Output compression point			11		dBm
IP3	Output IP3	$f_{BB} = 4.5, 5.5\text{ MHz}$		25		dBm
IP2	Output IP2	$f_{BB} = 4.5, 5.5\text{ MHz}$		65		dBm
	Carrier feedthrough	Unadjusted		-40		dBm
	Sideband suppression	Unadjusted		-42		dBc
	Output return loss			9		dB
	Output noise floor	$\geq 13\text{ MHz}$ offset from f_{LO} ; $P_{out} = -5\text{ dBm}$		-163		dBm/Hz
EVM	Error vector magnitude (rms)	1 EDGE signal, $P_{out} = -5\text{ dBm}^{(1)}$		0.64%		

(1) The contribution from the source of about 0.28% is not de-embedded from the measurement.

ELECTRICAL CHARACTERISTICS

over recommended operating conditions, power supply = 5 V, $T_A = 25^\circ\text{C}$, $V_{CM} = 1.7\text{ V}$, $f_{LO} = 1800\text{ MHz}$ at 8 dBm, $V_{inBB} = 98\text{ mVrms}$ single-ended in quadrature, $f_{BB} = 50\text{ kHz}$ (unless otherwise noted)

RF Output Parameters						
	PARAMETER	TEST CONDITIONS	MIN	TYP	MAX	UNIT
G	Voltage gain	Output rms voltage over input I (or Q) rms voltage		-2.5		dB
P1dB	Output compression point			12		dBm
IP3	Output IP3	$f_{BB} = 4.5, 5.5\text{ MHz}$		26		dBm
IP2	Output IP2	$f_{BB} = 4.5, 5.5\text{ MHz}$		60		dBm
	Carrier feedthrough	Unadjusted		-40		dBm
	Sideband suppression	Unadjusted		-50		dBc
	Output return loss			8		dB
	Output noise floor	$\geq 13\text{ MHz}$ offset from f_{LO} ; $P_{out} = -5\text{ dBm}$		-162		dBm/Hz
EVM	Error vector magnitude (rms)	1 EDGE signal, $P_{out} = -5\text{ dBm}^{(1)}$		0.41%		

(1) The contribution from the source of about 0.28% is not de-embedded from the measurement.

ELECTRICAL CHARACTERISTICS

over recommended operating conditions, power supply = 5 V, $T_A = 25^\circ\text{C}$, $V_{CM} = 1.7\text{ V}$, $f_{LO} = 1960\text{ MHz}$ at 8 dBm, $V_{inBB} = 98\text{ mVrms}$ single-ended in quadrature, $f_{BB} = 50\text{ kHz}$ (unless otherwise noted)

RF Output Parameters						
	PARAMETER	TEST CONDITIONS	MIN	TYP	MAX	UNIT
G	Voltage gain	Output rms voltage over input I (or Q) rms voltage		-2.5		dB
P1dB	Output compression point			12		dBm
IP3	Output IP3	$f_{BB} = 4.5, 5.5\text{ MHz}$	23.5	26.5		dBm
IP2	Output IP2	$f_{BB} = 4.5, 5.5\text{ MHz}$		60		dBm
	Carrier feedthrough	Unadjusted		-38		dBm
	Sideband suppression	Unadjusted		-50		dBc
	Output return loss			8		dB
	Output noise floor	$\geq 13\text{ MHz}$ offset from f_{LO} ; $P_{out} = -5\text{ dBm}$		-162.5		dBm/Hz
EVM	Error vector magnitude (rms)	1 EDGE signal; $P_{out} = -5\text{ dBm}^{(1)}$		0.43%		
ACPR ⁽²⁾	Adjacent-channel power ratio	1 WCDMA signal; $P_{out} = -8\text{ dBm}$		-74		dBc
		2 WCDMA signals; $P_{out} = -11\text{ dBm}$ per carrier		-68		
		4 WCDMA signals; $P_{out} = -14\text{ dBm}$ per carrier		-67		
	Alternate-channel power ratio	1 WCDMA signal; $P_{out} = -8\text{ dBm}$		-78		dBc
		2 WCDMA signals; $P_{out} = -11\text{ dBm}$ per carrier		-72		
		4 WCDMA signals; $P_{out} = -14\text{ dBm}$ per carrier		-69		

(1) The contribution from the source of about 0.28% is not de-embedded from the measurement.

(2) Measured with DAC5687 as source generator

ELECTRICAL CHARACTERISTICS

over recommended operating conditions, power supply = 5 V, $T_A = 25^\circ\text{C}$, $V_{CM} = 1.7\text{ V}$, $f_{LO} = 2140\text{ MHz}$ at 8 dBm, $V_{inBB} = 98\text{ mVrms}$ single-ended in quadrature, $f_{BB} = 50\text{ kHz}$ (unless otherwise noted)

RF Output Parameters						
	PARAMETER	TEST CONDITIONS	MIN	TYP	MAX	UNIT
G	Voltage gain	Output rms voltage over input I (or Q) rms voltage		-2.4		dB
P1dB	Output compression point			12		dBm
IP3	Output IP3	$f_{BB} = 4.5, 5.5\text{ MHz}$		26.5		dBm
IP2	Output IP2	$f_{BB} = 4.5, 5.5\text{ MHz}$		66		dBm
	Carrier feedthrough	Unadjusted		-38		dBm
	Sideband suppression	Unadjusted		-50		dBc
	Output return loss			8.5		dB
	Output noise floor	$\geq 13\text{ MHz}$ offset from f_{LO} ; $P_{out} = -5\text{ dBm}$		-162.5		dBm/Hz
ACPR ⁽¹⁾	Adjacent-channel power ratio	1 WCDMA signal; $P_{out} = -8\text{ dBm}$		-72		dBc
		2 WCDMA signal; $P_{out} = -11\text{ dBm}$ per carrier		-67		
		4 WCDMA signals; $P_{out} = -14\text{ dBm}$ per carrier		-66		
	Alternate-channel power ratio	1 WCDMA signal; $P_{out} = -8\text{ dBm}$		-78		dBc
		2 WCDMA signal; $P_{out} = -11\text{ dBm}$		-74		
		4 WCDMA signals; $P_{out} = -14\text{ dBm}$ per carrier		-68		

(1) Measured with DAC5687 as source generator

ELECTRICAL CHARACTERISTICS

over recommended operating conditions, power supply = 5 V, $T_A = 25^\circ\text{C}$, $V_{CM} = 1.7\text{ V}$, $f_{LO} = 2500\text{ MHz}$ at 8 dBm, $V_{inBB} = 98\text{ mVrms}$ single-ended in quadrature, $f_{BB} = 50\text{ kHz}$ (unless otherwise noted)

RF Output Parameters					
PARAMETER	TEST CONDITIONS	MIN	TYP	MAX	UNIT
G	Voltage gain	Output rms voltage over input I (or Q) rms voltage		-1.6	dB
P1dB	Output compression point			13	dBm
IP3	Output IP3	$f_{BB} = 4.5, 5.5\text{ MHz}$		29	dBm
IP2	Output IP2	$f_{BB} = 4.5, 5.5\text{ MHz}$		65	dBm
	Carrier feedthrough	Unadjusted		-37	dBm
	Sideband suppression	Unadjusted		-47	dBc
EVM	Error vector magnitude (rms)	WiMAX 5-MHz carrier, $P_{out} = -8\text{ dBm}$, LO = 8 dBm		-47	dB
		WiMAX 5-MHz carrier, $P_{out} = 0\text{ dBm}$, LO = 8 dBm		-45	dB

ELECTRICAL CHARACTERISTICS

over recommended operating conditions, power supply = 5 V, $T_A = 25^\circ\text{C}$, $V_{CM} = 1.7\text{ V}$, $f_{LO} = 3500\text{ MHz}$ at 8 dBm, $V_{inBB} = 98\text{ mVrms}$ single-ended in quadrature, $f_{BB} = 50\text{ kHz}$ (unless otherwise noted)

RF Output Parameters					
PARAMETER	TEST CONDITIONS	MIN	TYP	MAX	UNIT
G	Voltage gain	Output rms voltage over input I (or Q) rms voltage		0.6	dB
P1dB	Output compression point			13.5	dBm
IP3	Output IP3	$f_{BB} = 4.5, 5.5\text{ MHz}$		25	dBm
IP2	Output IP2	$f_{BB} = 4.5, 5.5\text{ MHz}$		65	dBm
	Carrier feedthrough	Unadjusted		-35	dBm
	Sideband suppression	Unadjusted		-36	dBc
EVM	Error vector magnitude (rms)	WiMAX 5-MHz carrier, $P_{out} = -8\text{ dBm}$, LO = 6 dBm		-47	dB
		WiMAX 5-MHz carrier, $P_{out} = 0\text{ dBm}$, LO = 6 dBm		-43	dB

ELECTRICAL CHARACTERISTICS

over recommended operating conditions, power supply = 5 V, $T_A = 25^\circ\text{C}$, $V_{CM} = 1.7\text{ V}$, $f_{LO} = 4000\text{ MHz}$ at 8 dBm, $V_{inBB} = 98\text{ mVrms}$ single-ended in quadrature, $f_{BB} = 50\text{ kHz}$ (unless otherwise noted)

RF Output Parameters					
PARAMETER	TEST CONDITIONS	MIN	TYP	MAX	UNIT
G	Voltage gain	Output rms voltage over input I (or Q) rms voltage		0.2	dB
P1dB	Output compression point			12	dBm
IP3	Output IP3	$f_{BB} = 4.5, 5.5\text{ MHz}$		22.5	dBm
IP2	Output IP2	$f_{BB} = 4.5, 5.5\text{ MHz}$		60	dBm
	Carrier feedthrough	Unadjusted		-36	dBm
	Sideband suppression	Unadjusted		-36	dBc

TYPICAL CHARACTERISTICS

$V_{CM} = 1.7\text{ V}$, $V_{inBB} = 98\text{ mVrms}$ single-ended sine wave in quadrature, $V_{CC} = 5\text{ V}$, LO power = 8 dBm (single-ended), $f_{BB} = 50\text{ kHz}$ (unless otherwise noted).

**OUTPUT POWER
vs
BASEBAND VOLTAGE**

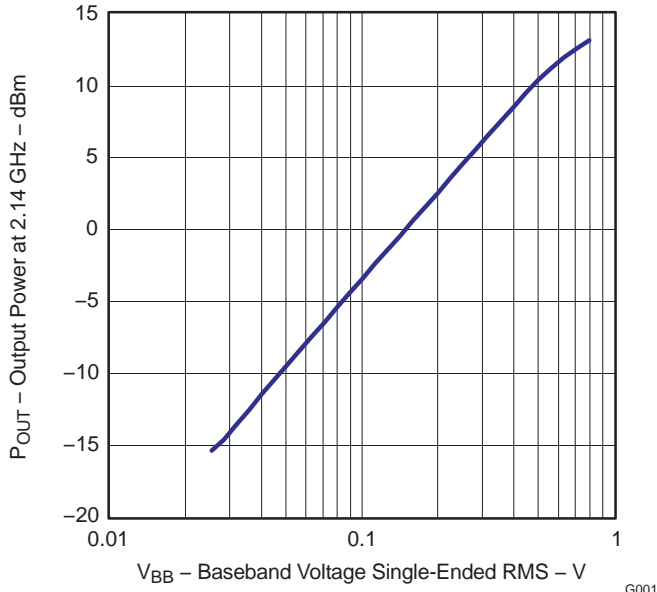

Figure 1.

**OUTPUT POWER
vs
FREQUENCY AND TEMPERATURE**

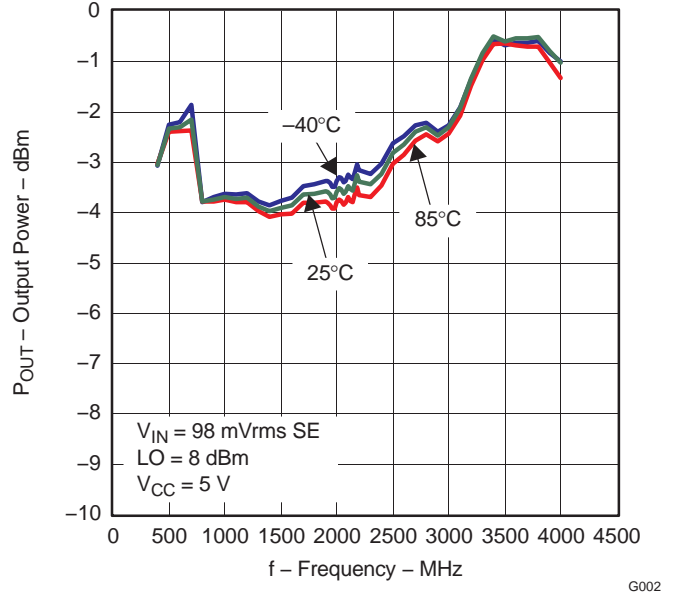

Figure 2.

**OUTPUT POWER
vs
FREQUENCY AND SUPPLY VOLTAGE**

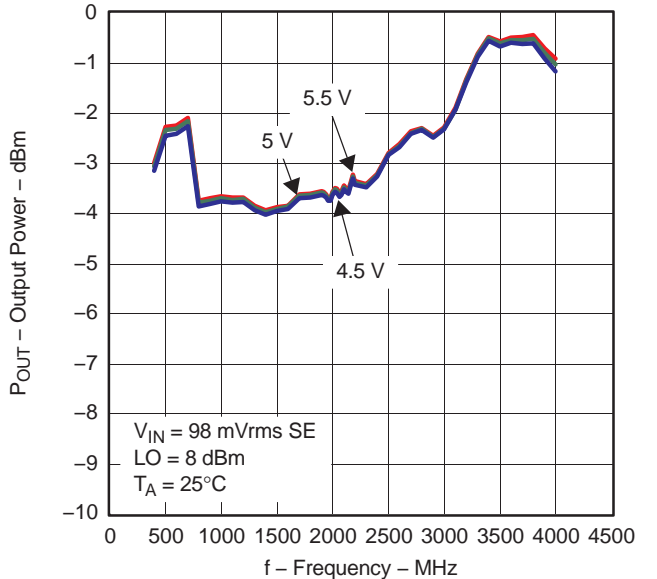

Figure 3.

**OUTPUT POWER
vs
FREQUENCY AND LO POWER**

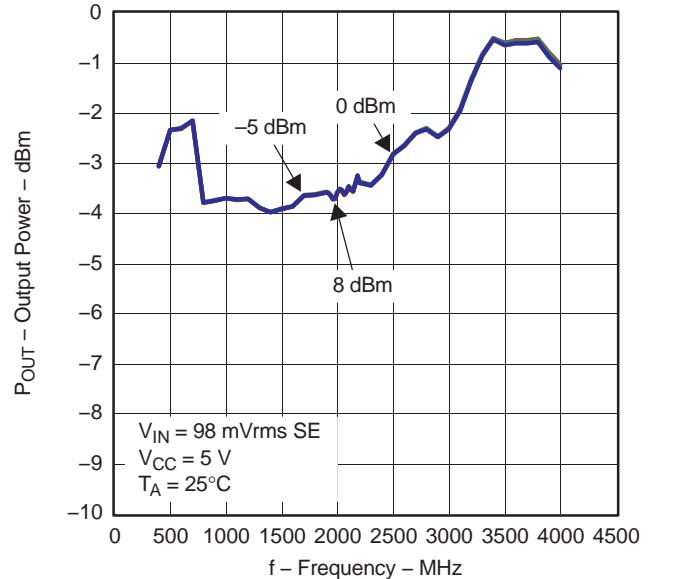

Figure 4.

TYPICAL CHARACTERISTICS (continued)

$V_{CM} = 1.7\text{ V}$, $V_{inBB} = 98\text{ mVrms}$ single-ended sine wave in quadrature, $V_{CC} = 5\text{ V}$, LO power = 8 dBm (single-ended), $f_{BB} = 50\text{ kHz}$ (unless otherwise noted).

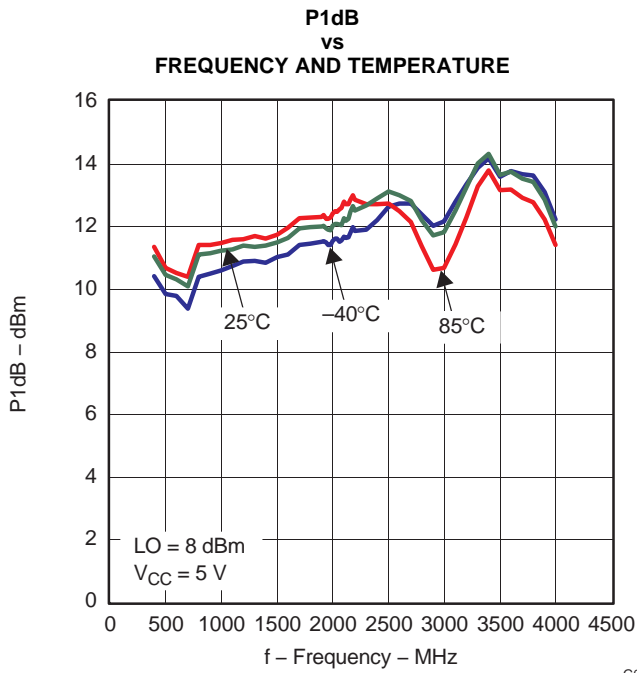

Figure 5.

G005

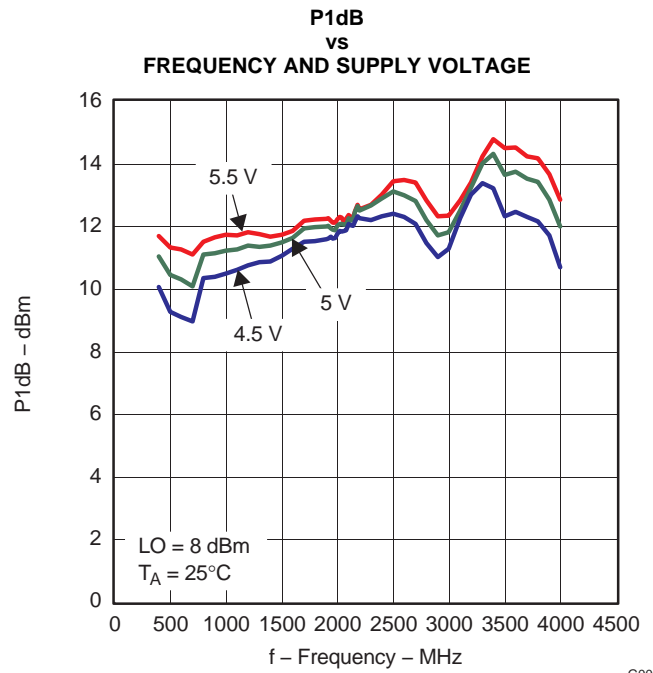

Figure 6.

G006

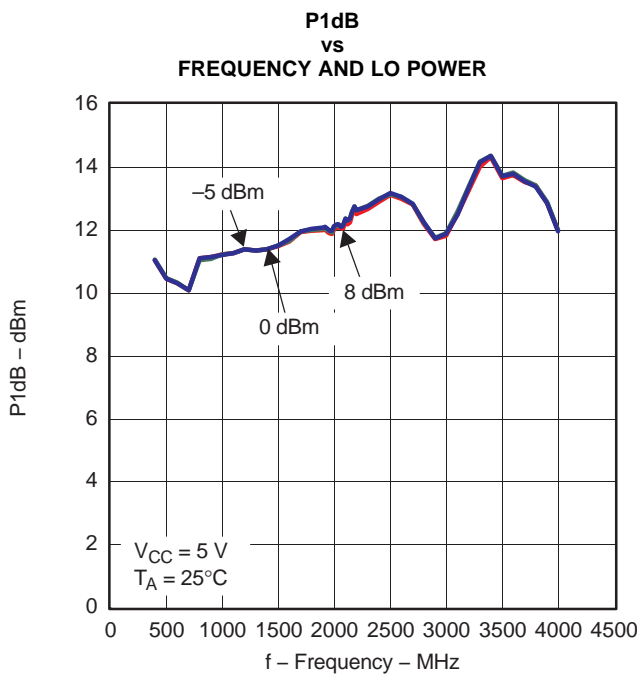

Figure 7.

G007

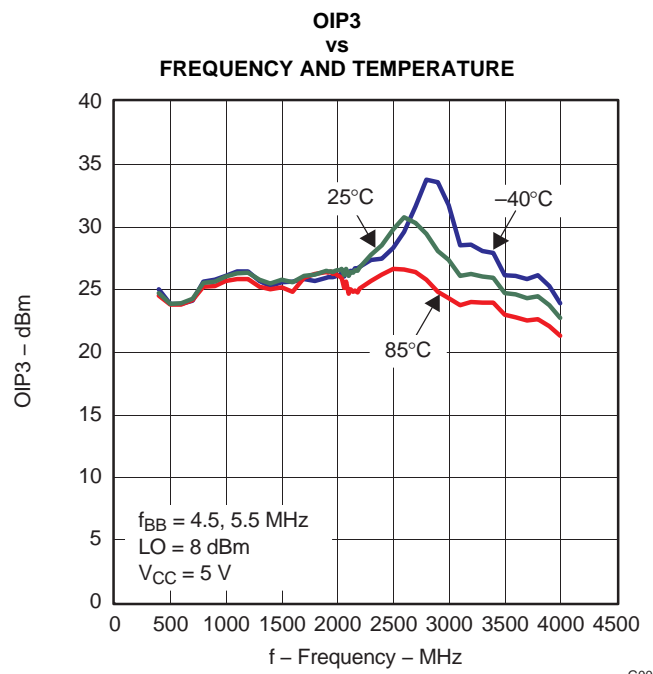

Figure 8.

G008

TYPICAL CHARACTERISTICS (continued)

$V_{CM} = 1.7\text{ V}$, $V_{inBB} = 98\text{ mVrms}$ single-ended sine wave in quadrature, $V_{CC} = 5\text{ V}$, LO power = 8 dBm (single-ended), $f_{BB} = 50\text{ kHz}$ (unless otherwise noted).

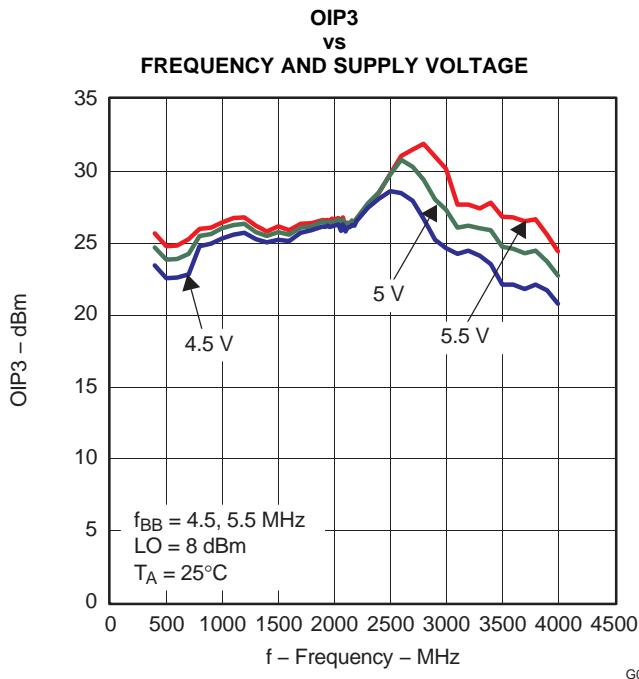

Figure 9.

G009

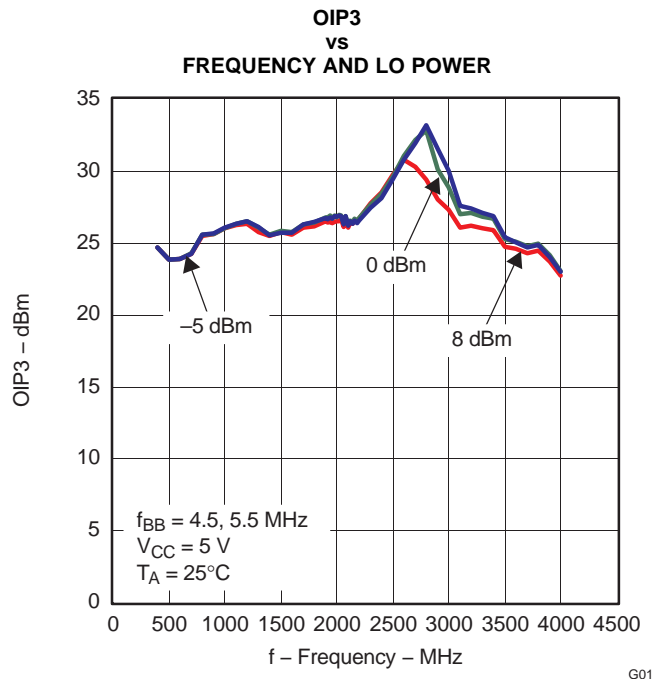

Figure 10.

G010

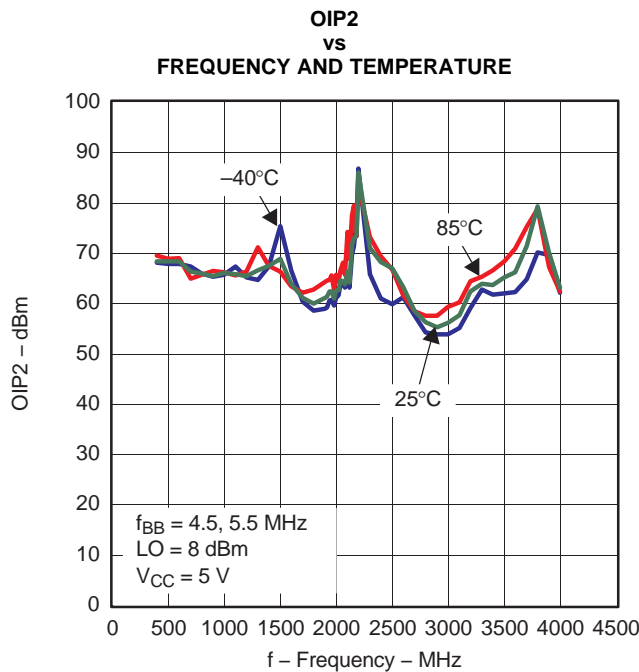

Figure 11.

G011

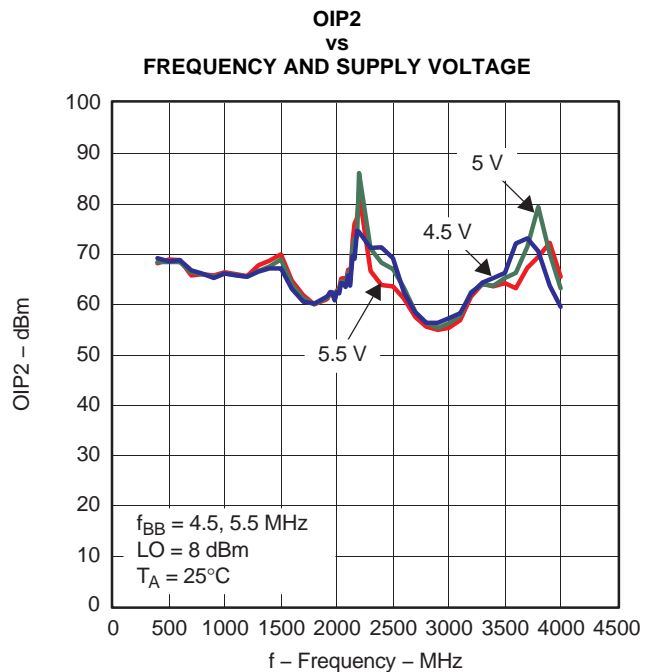

Figure 12.

G012

TYPICAL CHARACTERISTICS (continued)

$V_{CM} = 1.7\text{ V}$, $V_{inBB} = 98\text{ mVrms}$ single-ended sine wave in quadrature, $V_{CC} = 5\text{ V}$, LO power = 8 dBm (single-ended), $f_{BB} = 50\text{ kHz}$ (unless otherwise noted).

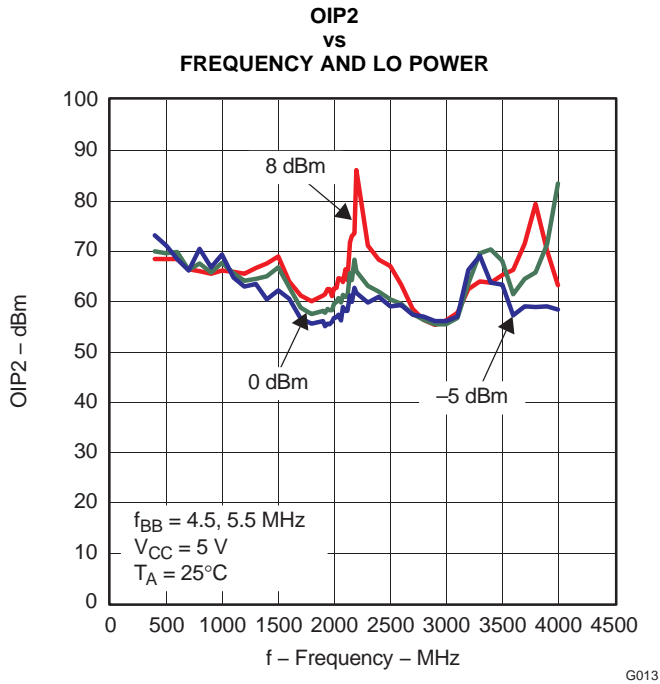

Figure 13.

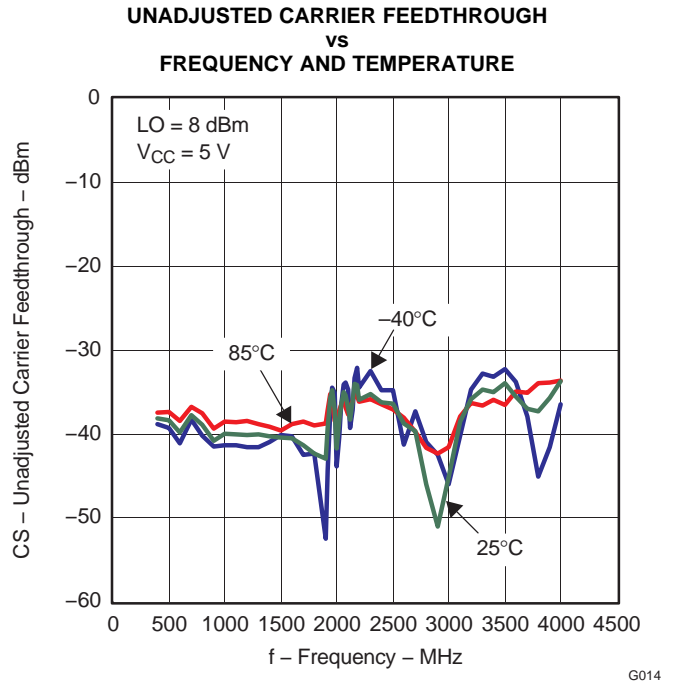

Figure 14.

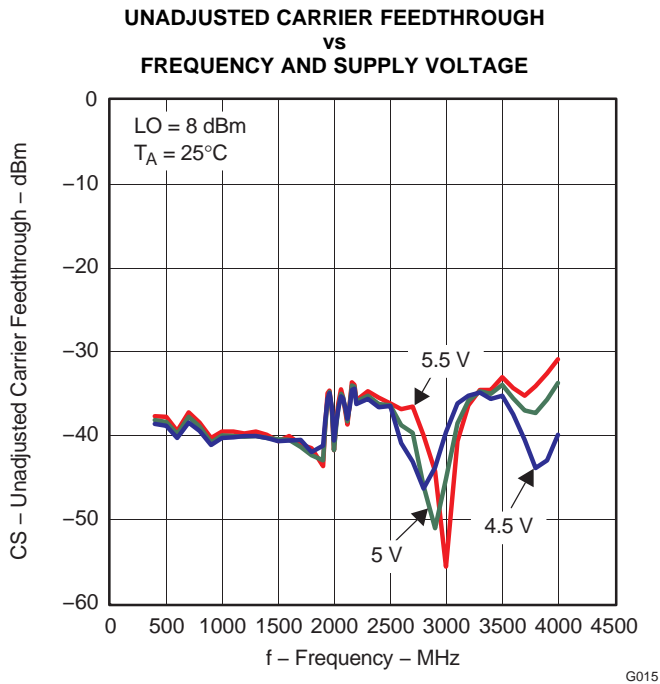

Figure 15.

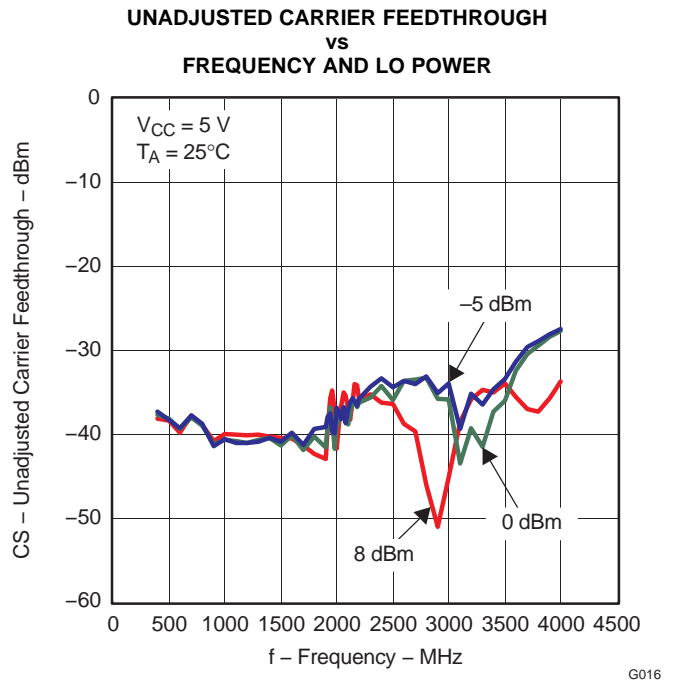

Figure 16.

TYPICAL CHARACTERISTICS (continued)

$V_{CM} = 1.7\text{ V}$, $V_{inBB} = 98\text{ mVrms}$ single-ended sine wave in quadrature, $V_{CC} = 5\text{ V}$, LO power = 8 dBm (single-ended), $f_{BB} = 50\text{ kHz}$ (unless otherwise noted).

UNADJUSTED SIDEBAND SUPPRESSION vs FREQUENCY AND TEMPERATURE

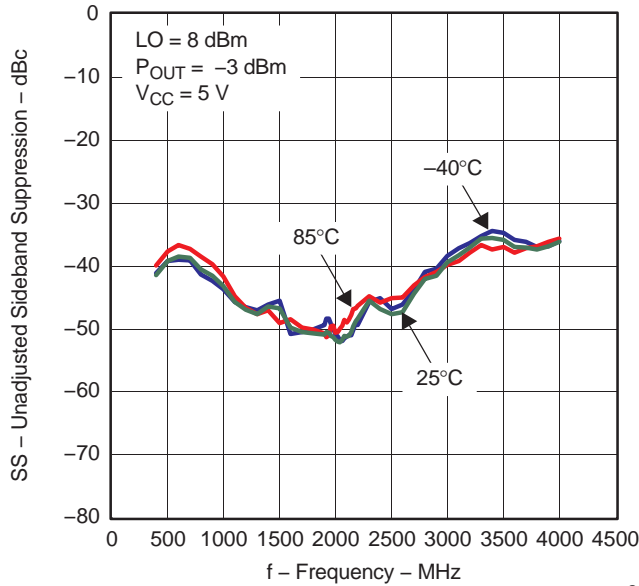

Figure 17.

UNADJUSTED SIDEBAND SUPPRESSION vs FREQUENCY AND SUPPLY VOLTAGE

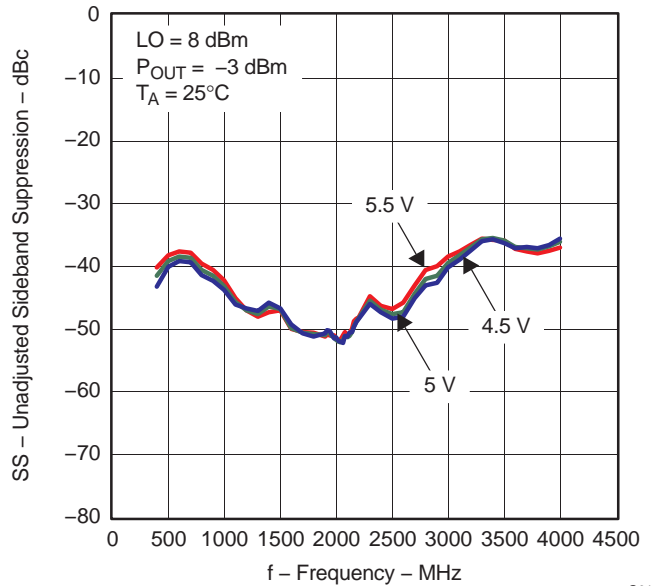

Figure 18.

UNADJUSTED SIDEBAND SUPPRESSION vs FREQUENCY AND LO POWER

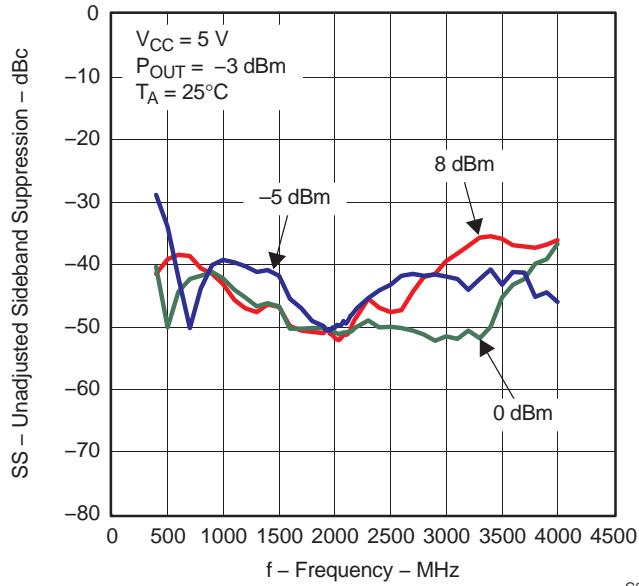

Figure 19.

NOISE AT 13-MHz OFFSET (dBm/Hz) vs FREQUENCY AND TEMPERATURE

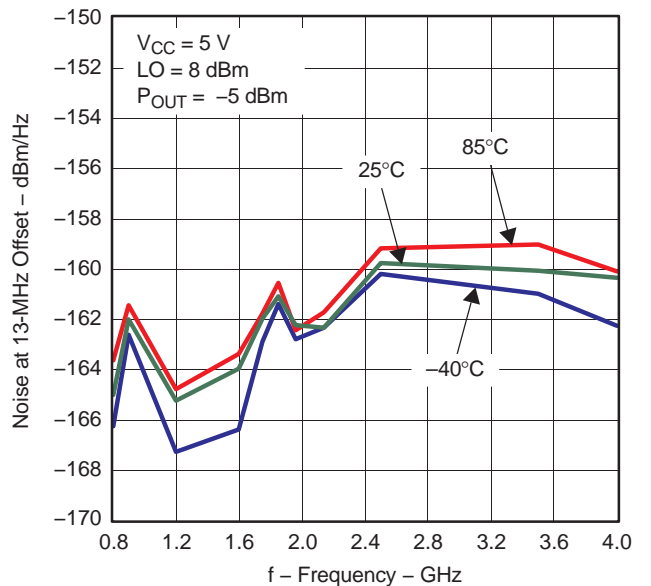

Figure 20.

TYPICAL CHARACTERISTICS (continued)

$V_{CM} = 1.7\text{ V}$, $V_{inBB} = 98\text{ mVrms}$ single-ended sine wave in quadrature, $V_{CC} = 5\text{ V}$, LO power = 8 dBm (single-ended), $f_{BB} = 50\text{ kHz}$ (unless otherwise noted).

**NOISE AT 13-MHz OFFSET (dBm/Hz)
vs
FREQUENCY AND SUPPLY VOLTAGE**

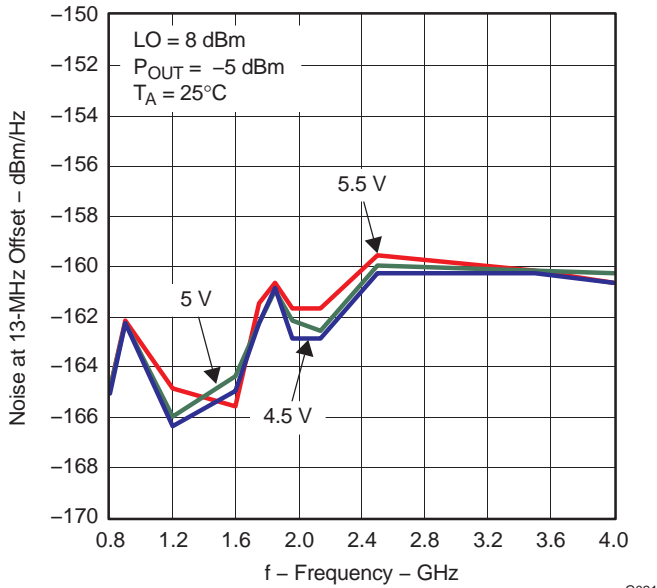

Figure 21.

**NOISE AT 13-MHz OFFSET (dBm/Hz)
vs
OUTPUT POWER**

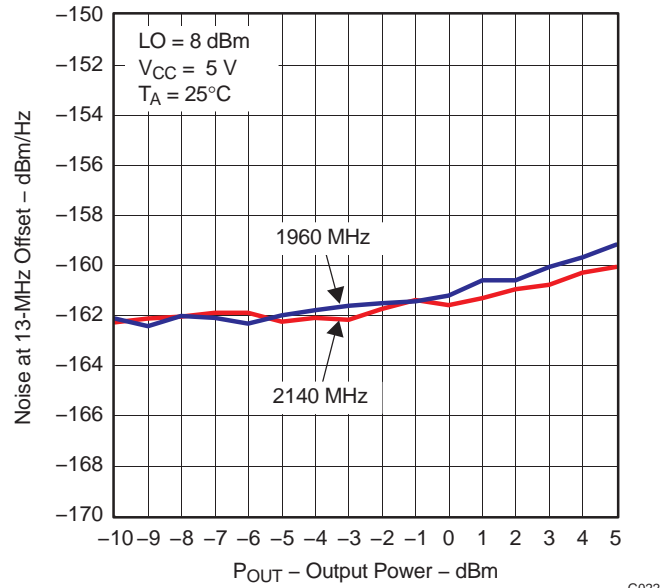

Figure 22.

**ADJUSTED CARRIER FEEDTHROUGH
vs
FREQUENCY AND TEMPERATURE**

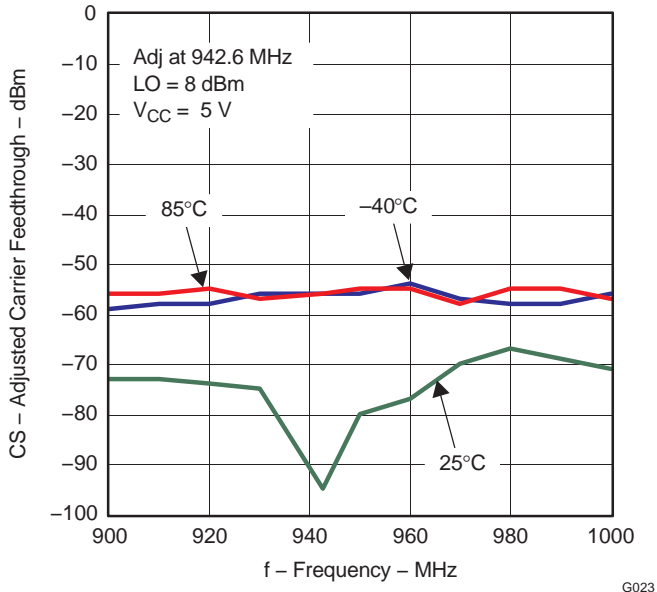

Figure 23.

**ADJUSTED CARRIER FEEDTHROUGH
vs
FREQUENCY AND TEMPERATURE**

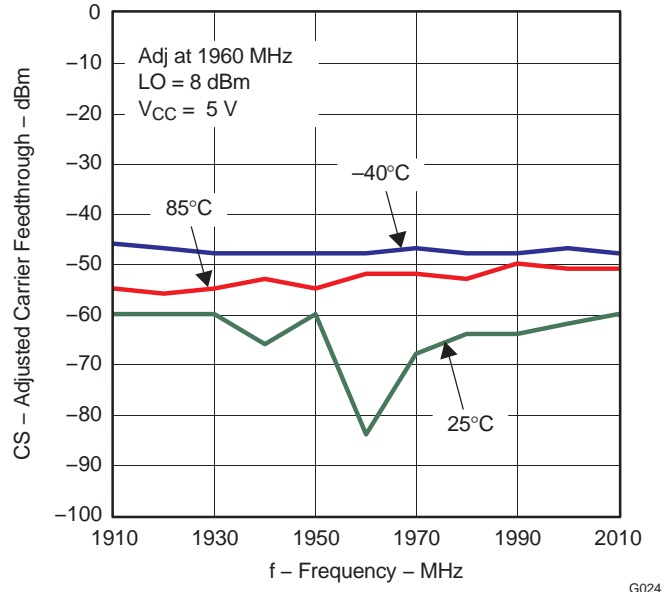

Figure 24.

TYPICAL CHARACTERISTICS (continued)

$V_{CM} = 1.7\text{ V}$, $V_{inBB} = 98\text{ mVrms}$ single-ended sine wave in quadrature, $V_{CC} = 5\text{ V}$, LO power = 8 dBm (single-ended), $f_{BB} = 50\text{ kHz}$ (unless otherwise noted).

**ADJUSTED CARRIER FEEDTHROUGH
vs
FREQUENCY AND TEMPERATURE**

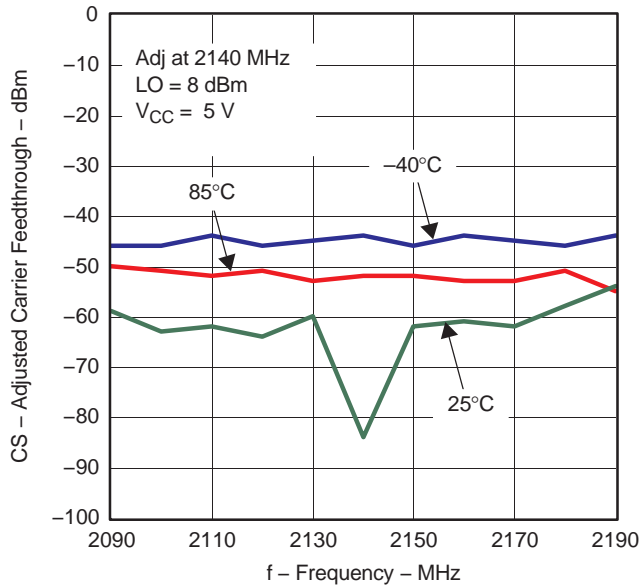

Figure 25.

**ADJUSTED CARRIER FEEDTHROUGH
vs
FREQUENCY AND TEMPERATURE**

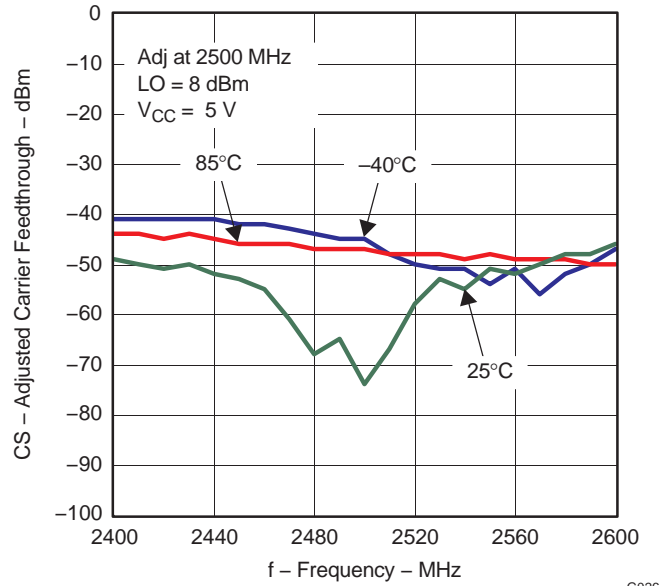

Figure 26.

**ADJUSTED CARRIER FEEDTHROUGH
vs
FREQUENCY AND TEMPERATURE**

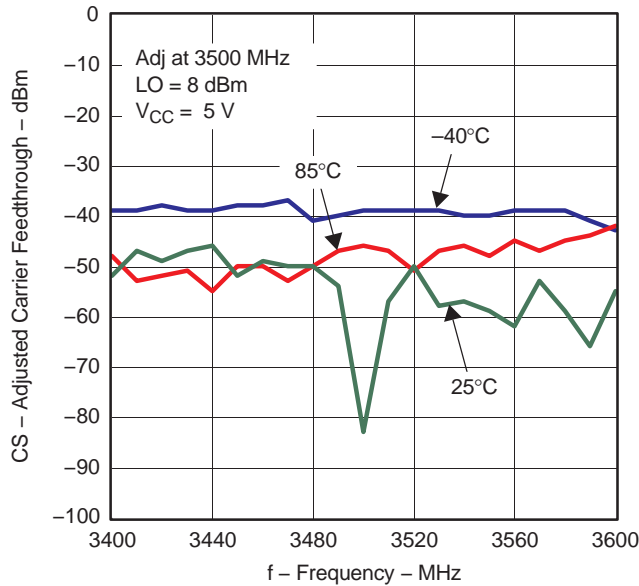

Figure 27.

**ADJUSTED SIDEBAND SUPPRESSION
vs
FREQUENCY AND TEMPERATURE**

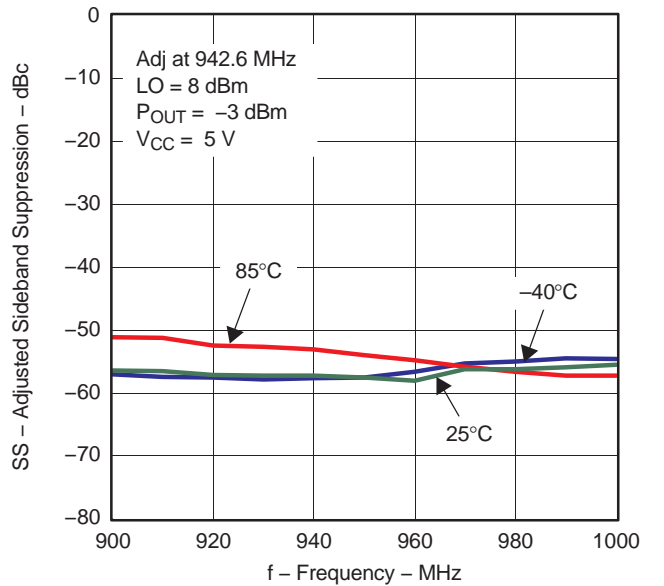

Figure 28.

TYPICAL CHARACTERISTICS (continued)

$V_{CM} = 1.7\text{ V}$, $V_{inBB} = 98\text{ mVrms}$ single-ended sine wave in quadrature, $V_{CC} = 5\text{ V}$, LO power = 8 dBm (single-ended), $f_{BB} = 50\text{ kHz}$ (unless otherwise noted).

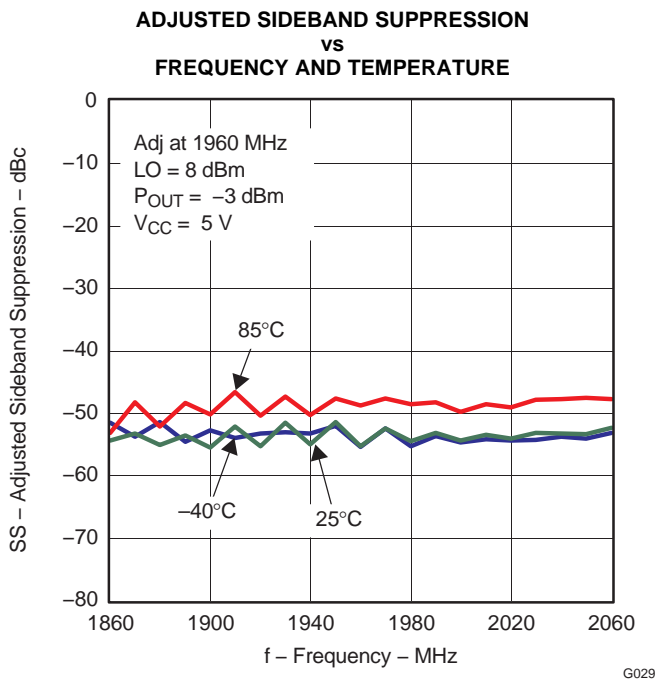

Figure 29.

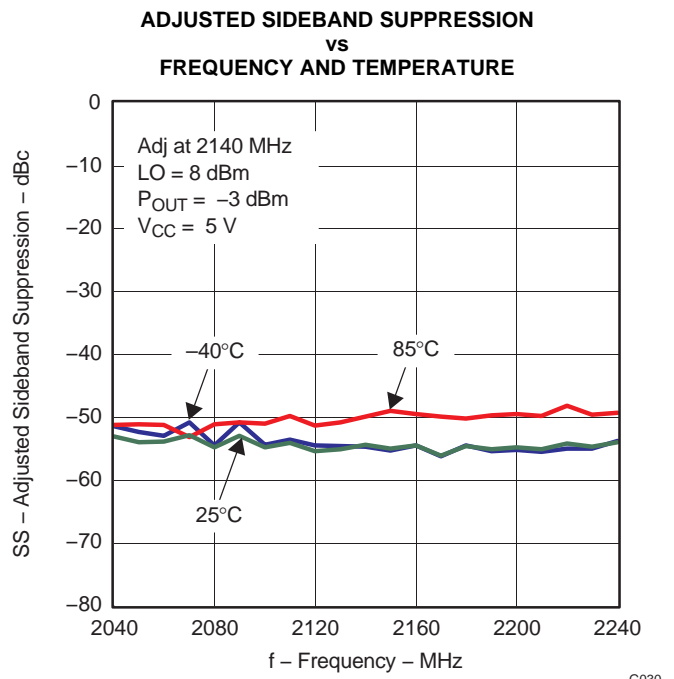

Figure 30.

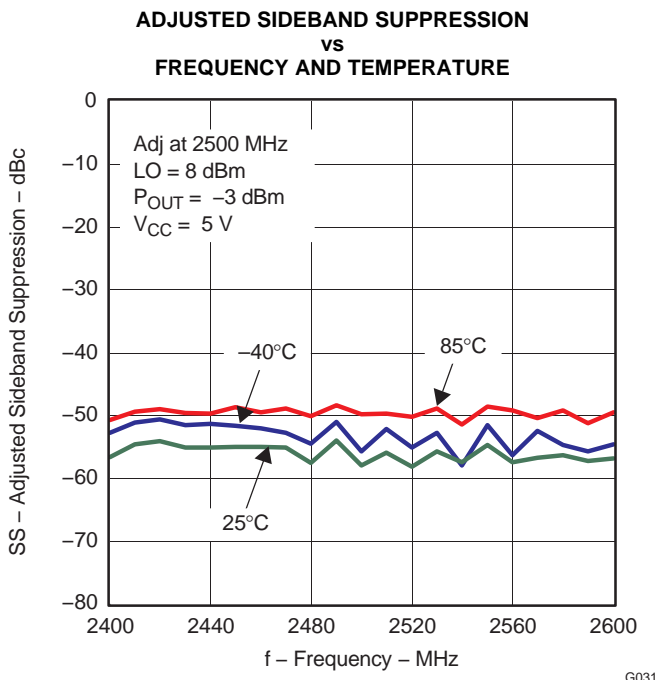

Figure 31.

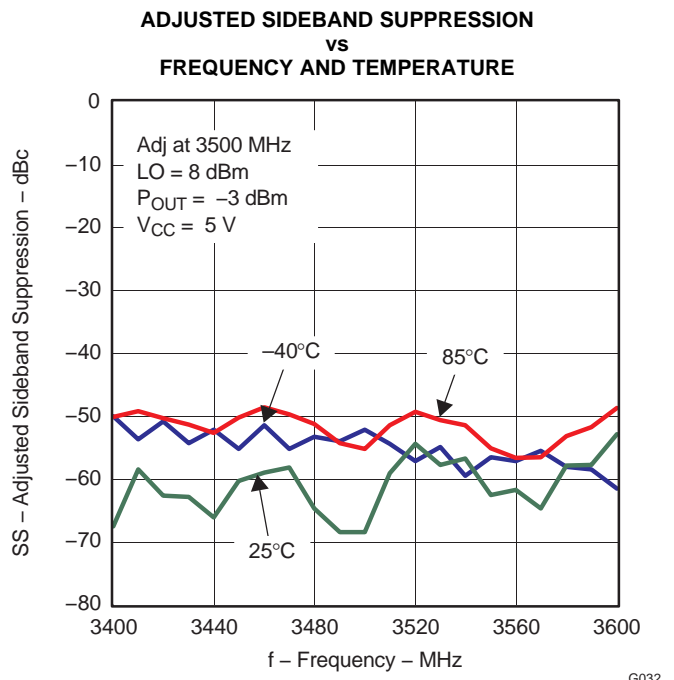

Figure 32.

TYPICAL CHARACTERISTICS (continued)

$V_{CM} = 1.7\text{ V}$, $V_{inBB} = 98\text{ mVrms}$ single-ended sine wave in quadrature, $V_{CC} = 5\text{ V}$, LO power = 8 dBm (single-ended), $f_{BB} = 50\text{ kHz}$ (unless otherwise noted).

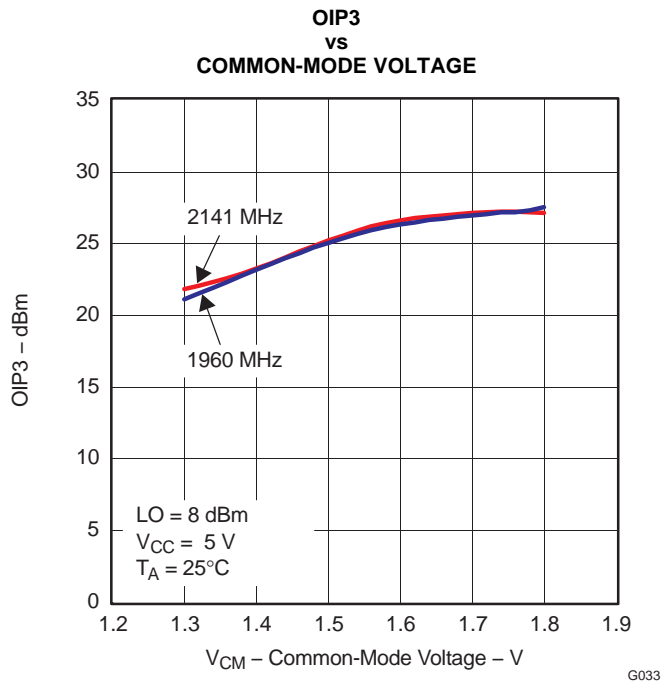

Figure 33.

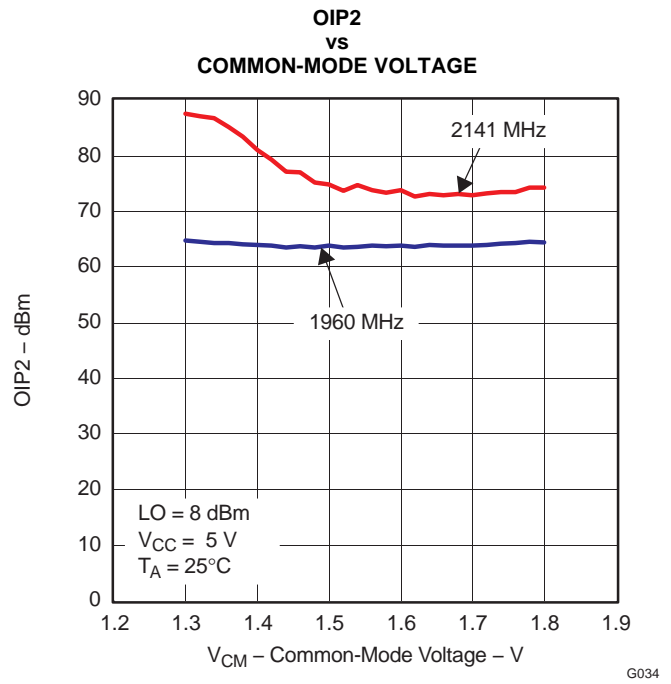

Figure 34.

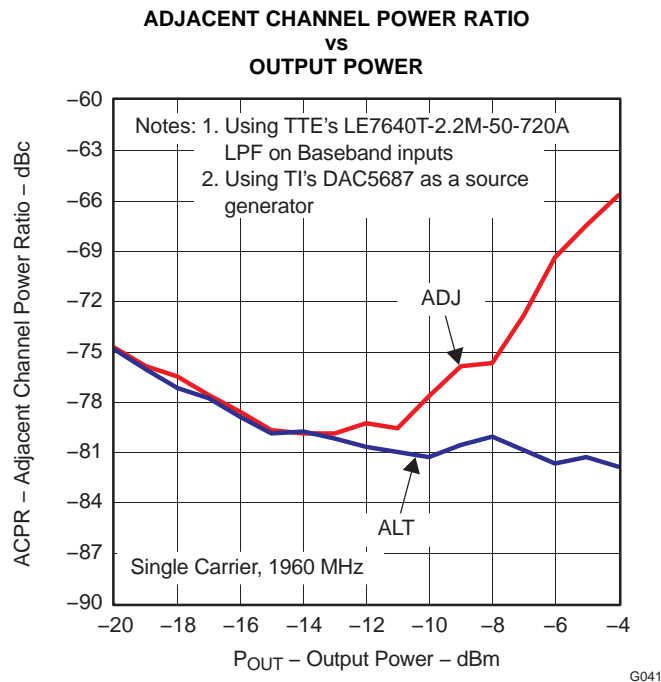

Figure 35.

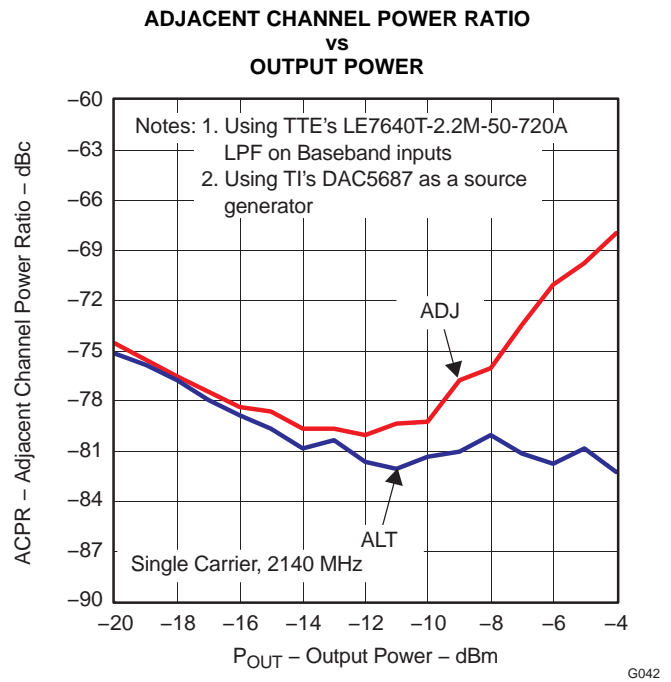

Figure 36.

TYPICAL CHARACTERISTICS (continued)

$V_{CM} = 1.7\text{ V}$, $V_{inBB} = 98\text{ mVrms}$ single-ended sine wave in quadrature, $V_{CC} = 5\text{ V}$, LO power = 8 dBm (single-ended), $f_{BB} = 50\text{ kHz}$ (unless otherwise noted).

OIP3 at 1960 MHz DISTRIBUTION

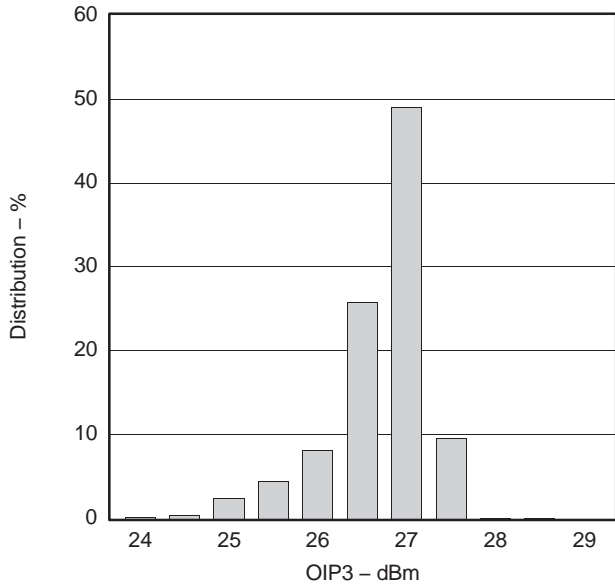

Figure 37.

G036

OIP2 at 1960 MHz DISTRIBUTION

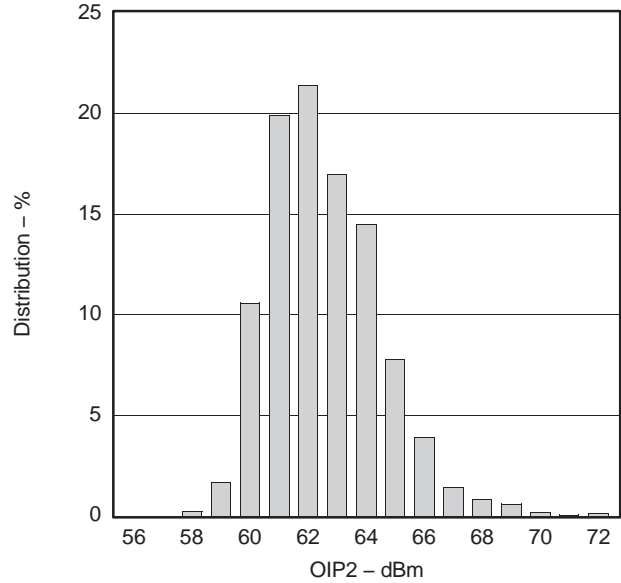

Figure 38.

G037

UNADJUSTED CARRIER FEEDTHROUGH at 1960 MHz DISTRIBUTION

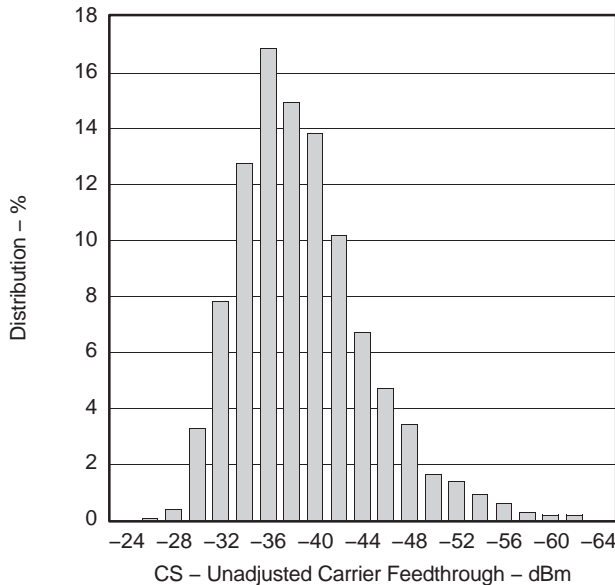

Figure 39.

G038

UNADJUSTED SIDEBAND SUPPRESSION at 1960 MHz DISTRIBUTION

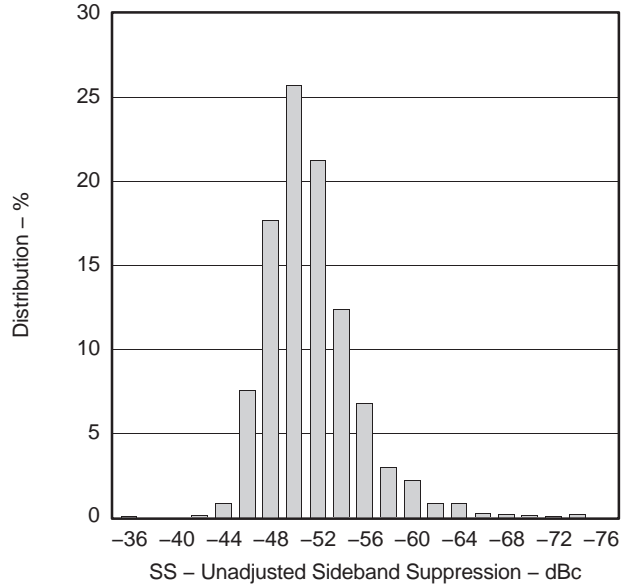

Figure 40.

G039

TYPICAL CHARACTERISTICS (continued)

$V_{CM} = 1.7\text{ V}$, $V_{inBB} = 98\text{ mVrms}$ single-ended sine wave in quadrature, $V_{CC} = 5\text{ V}$, LO power = 8 dBm (single-ended), $f_{BB} = 50\text{ kHz}$ (unless otherwise noted).

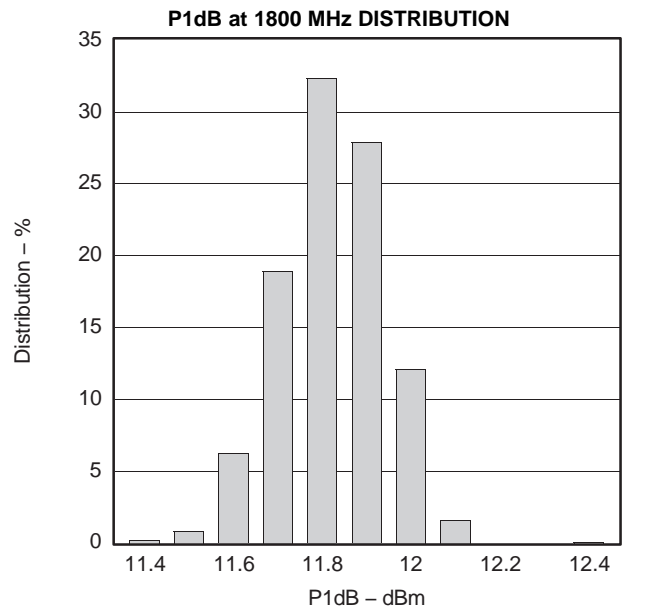

Figure 41.

APPLICATION INFORMATION AND EVALUATION BOARD

Basic Connections

- See [Figure 42](#) for proper connection of the TRF3703 modulator.
- Connect a single power supply (4.5 V–5.5 V) to pins 18 and 24. These pins should be decoupled as shown on pins 4, 5, 6, and 7.
- Connect pins 2, 5, 8, 11, 12, 14, 17, 19, 20, and 23 to GND.
- Connect a single-ended LO source of desired frequency to LOP (amplitude between –5 dBm and 12 dBm). This should be ac-coupled through a 100-pF capacitor.
- Terminate the ac-coupled LON with 50 Ω to GND.
- Connect a baseband signal to pins 21 = I, 22 = \bar{I} , 10 = Q, and 9 = \bar{Q} .
- The differential baseband inputs should be set to the proper common-mode voltage of 1.7V.
- RF_OUT, pin 16, can be fed to a spectrum analyzer set to the desired frequency, LO \pm baseband signal. This pin should also be ac-coupled through a 100-pF capacitor.
- All NC pins can be left floating.

ESD Sensitivity

RF devices may be extremely sensitive to electrostatic discharge (ESD). To prevent damage from ESD, devices should be stored and handled in a way that prevents the build-up of electrostatic voltages that exceed the rated level. Rated ESD levels should also not be exceeded while the device is installed on a printed circuit board (PCB). Follow these guidelines for optimal ESD protection:

- Low ESD performance is not uncommon in RF ICs; see the [Absolute Maximum Ratings](#) table. Therefore, customers' ESD precautions should be consistent with these ratings.
- The device should be robust once assembled onto the PCB **unless** external inputs (connectors, etc.) directly connect the device pins to off-board circuits.

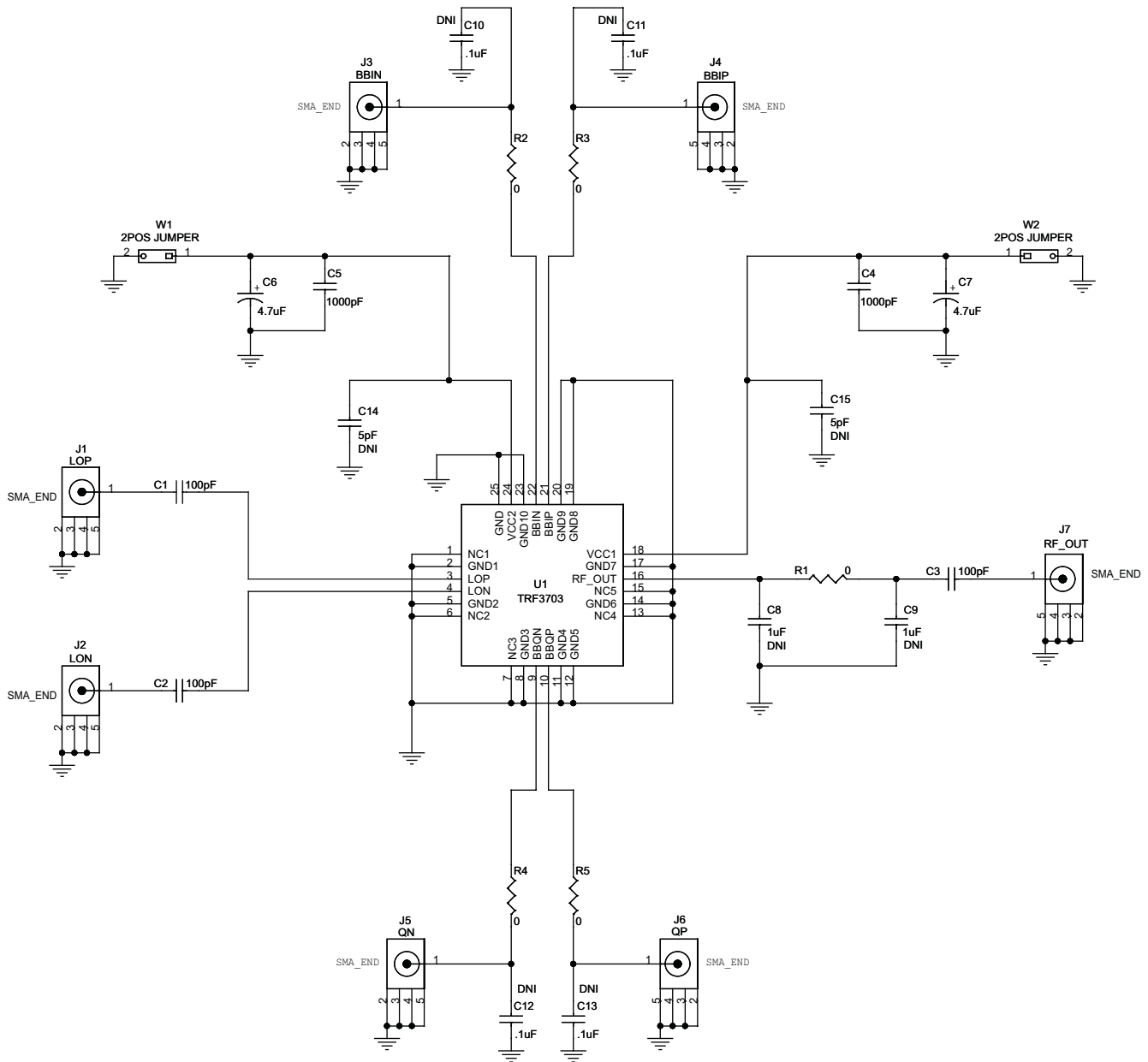

S0214-02

NOTE: DNI = Do not install.

Figure 42. TRF3703 EVM Schematic

Figure 43 shows the top view of the TRF3703 EVM board.

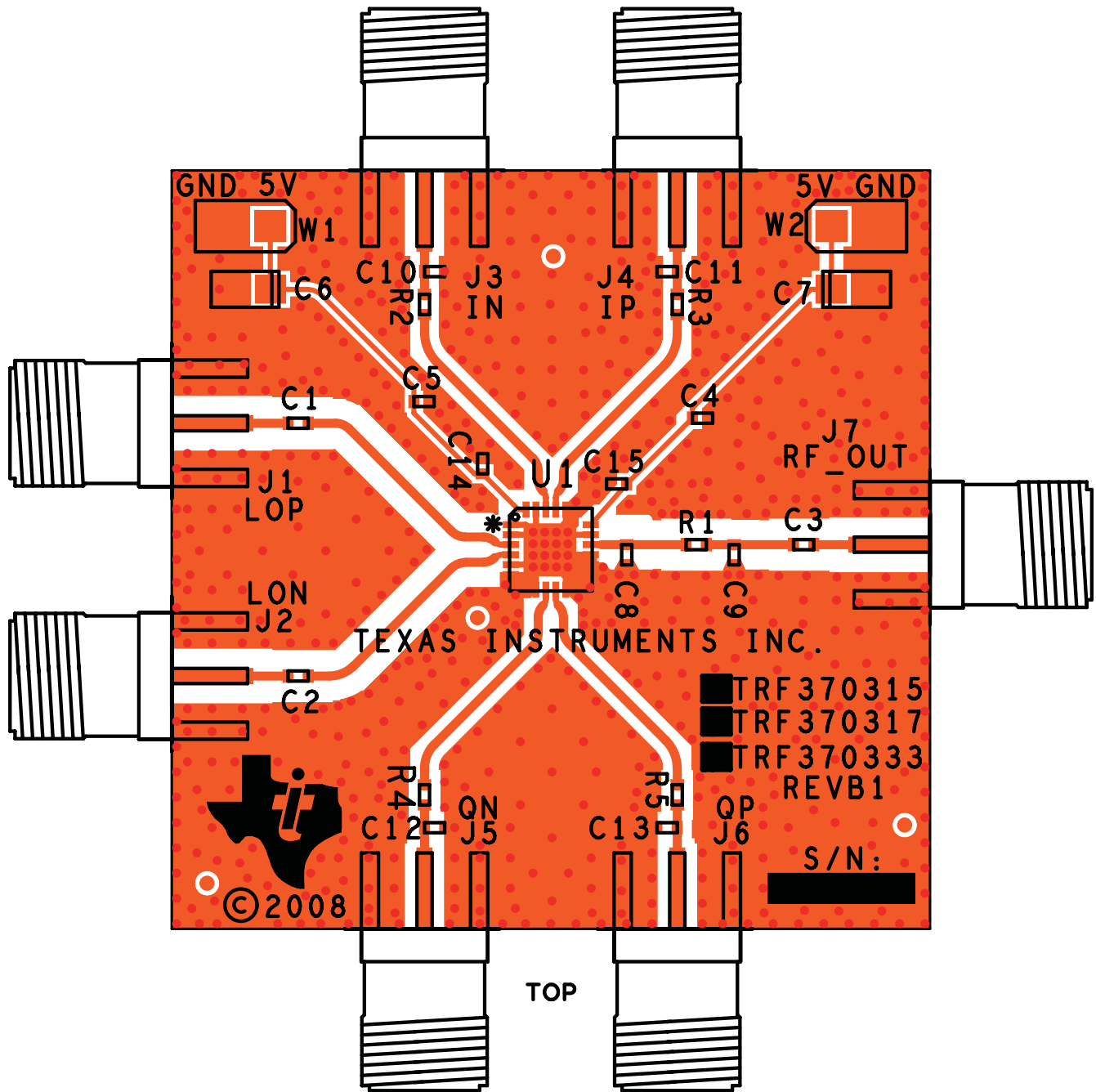

Figure 43. TRF3703 EVM Board Layout

K001

Table 1. Bill of Materials for TRF3703 EVM

Item Number	Quantity	Part Reference	Value	PCB Footprint	Mfr Name	Mfr Part Number	Note
1	3	C1, C2, C3	100 pF	0402	Panasonic	ECJ-0EC1H101J	
2	2	C4, C5	1000 pF	0402	Panasonic	ECJ-0VC1H102J	
3	2	C6, C7	4.7 μ F	TANT_A	KEMET	T491A475K016AS	
4	0	C8, C9	1 μ F	0402	Panasonic	ECJ-0EC1H010C_DNI	DNI ⁽¹⁾
5	0	C10, C11, C12, C13	0.1 μ F	0402	Panasonic	ECJ-0EB1A104K_DNI	DNI ⁽¹⁾
6	0	C14, C15	5 pF	0402	Panasonic	ECJ-0EC1H050C_DNI	DNI ⁽¹⁾
7	7	J1, J2, J3, J4, J5, J6, J7	LOP	SMA_SMEL_250x215	Johnson Components	142-0711-821	
8	1	R1	0	0402	Panasonic	ERJ-2GE0R00X	
9	4	R2, R3, R4, R5	0	0402	Panasonic	ERJ-2GE0R00	
10	1	U1	TRF3703	QFN_24_163x163_0p50mm	TI	TRF370317	
11	2	W1, W2	Jumper_1x2_t hvt	HDR_THVT_1x2_100	Samtec	HTSW-150-07-L-S	

(1) DNI = Do not install.

GSM Applications

The TRF370317 is suited for GSM and multicarrier GSM applications because of its high linearity and low noise level over the entire recommended operating range. It also has excellent EVM performance, which makes it ideal for the stringent GSM/EDGE applications.

WCDMA Applications

The TRF370317 is also optimized for WCDMA applications where both adjacent-channel power ratio (ACPR) and noise density are critically important. Using Texas instruments' DAC568X series of high-performance digital-to-analog converters as depicted in Figure 44, excellent ACPR levels were measured with one-, two-, and four-WCDMA carriers. See *Electrical Characteristics*, $f_{LO} = 1960$ MHz and $f_{LO} = 2140$ MHz for exact ACPR values.

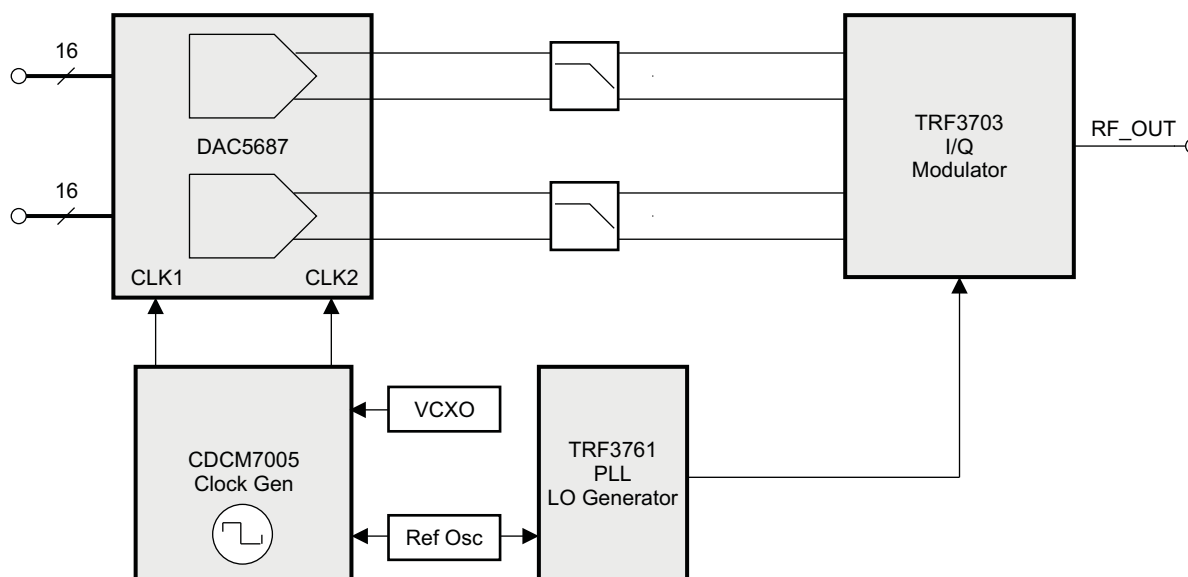

B0176-01

Figure 44. Typical Transmit Setup Block Diagram

DAC-to-Modulator Interface Network

For optimum linearity and dynamic range, the digital-to-analog converter (DAC) can interface directly with the modulator; however, the common-mode voltage of each device must be maintained. A passive interface circuit is used to transform the common-mode voltage of the DAC to the desired set-point of the modulator. The passive circuit invariably introduces some insertion loss between the two devices. In general, it is desirable to keep the insertion loss as low as possible to achieve the best dynamic range. Figure 45 shows the passive interconnect circuit for two different topologies. One topology is used when the DAC (e.g., DAC568x) common mode is larger than the modulator. The voltage V_{ee} is nominally set to ground, but can be set to a negative voltage to reduce the insertion loss of the network. The second topology is used when the DAC (e.g., DAC56x2) common mode is smaller than the modulator. Note that this passive interconnect circuit is duplicated for each of the differential I/Q branches.

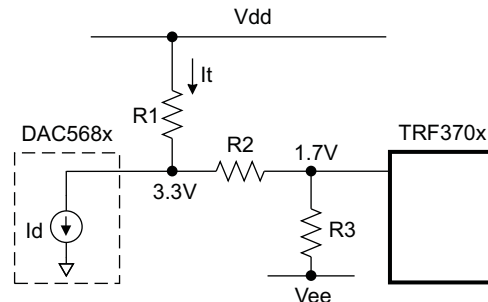

Topology 1: DAC $V_{cm} >$ TRF370x V_{cm}

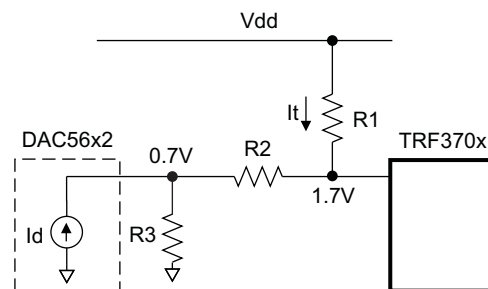

Topology 2: DAC $V_{cm} <$ TRF370x V_{cm}

S0338-01

Figure 45. Passive DAC-to-Modulator Interface Network

Table 2. DAC-to-Modulator Interface Network Values

	Topology 1		Topology 2
	With $V_{ee} = 0\text{ V}$	With $V_{ee} = -5\text{ V}$	
DAC V_{cm} [V]	3.3	3.3	0.7
TRF370x V_{cm} [V]	1.7	1.7	1.7
Vdd [V]	5	5	5
Vee [V]	Gnd	-5	N/A
R1 [Ω]	66	56	960
R2 [Ω]	100	80	290
R3 [Ω]	108	336	52
Insertion loss [dB]	5.8	1.9	2.3

DEFINITION OF SPECIFICATIONS

Unadjusted Carrier Feedthrough

This specification measures the amount by which the local oscillator component is suppressed in the output spectrum of the modulator. If the common mode voltage at each of the baseband inputs is exactly the same and there was no dc imbalance introduced by the modulator, the LO component would be naturally suppressed. DC offset imbalances in the device allow some of the LO component to feed through to the output. Because this phenomenon is independent of the RF output power and the injected LO input power, the parameter is expressed in absolute power, dBm.

Some improvement to the unadjusted carrier suppression in a localized band is possible by introducing a simple RF filter in the baseband I/Q paths. The filter topology is a series resistor followed by a shunt capacitor. For example, using a series 50- Ω resistor (R_2 , R_3 , R_4 , $R_5 = 50 \Omega$) followed by a shunt 4.7-pF capacitor (C_{10} , C_{11} , C_{12} , $C_{13} = 4.7 \text{ pF}$) yields unadjusted carrier suppression improvement around the 2-GHz band. Figure 46 shows the performance improvement for that filter configuration.

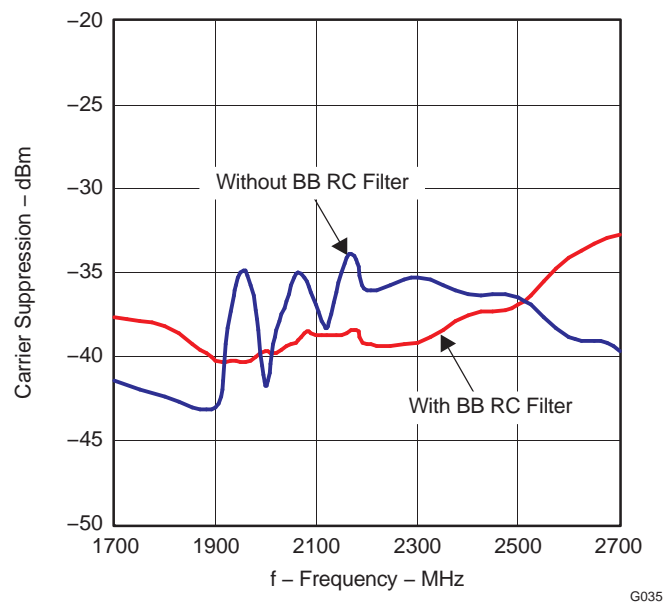

Figure 46. Carrier Suppression Improvement With RC Filter

Adjusted (Optimized) Carrier Feedthrough

This differs from the unadjusted suppression number in that the baseband input dc offsets are iteratively adjusted around their theoretical value of VCM to yield the maximum suppression of the LO component in the output spectrum. This is measured in dBm.

Unadjusted Sideband Suppression

This specification measures the amount by which the unwanted sideband of the input signal is suppressed in the output of the modulator, relative to the wanted sideband. If the amplitude and phase within the I and Q branch of the modulator were perfectly matched, the unwanted sideband (or image) would be naturally suppressed. Amplitude and phase imbalance in the I and Q branches results in the increase of the unwanted sideband. This parameter is measured in dBc relative to the desired sideband.

Adjusted (Optimized) Sideband Suppression

This differs from the unadjusted sideband suppression in that the gain and phase of the baseband inputs are iteratively adjusted around their theoretical values to maximize the amount of sideband suppression. This is measured in dBc.

Suppressions Over Temperature

This specification assumes that the user has gone through the optimization process for the suppression in question, and set the optimal settings for the I, Q inputs. This specification then measures the suppression when temperature conditions change after the initial calibration is done.

Figure 47 shows a simulated output and illustrates the respective definitions of various terms used in this data sheet.

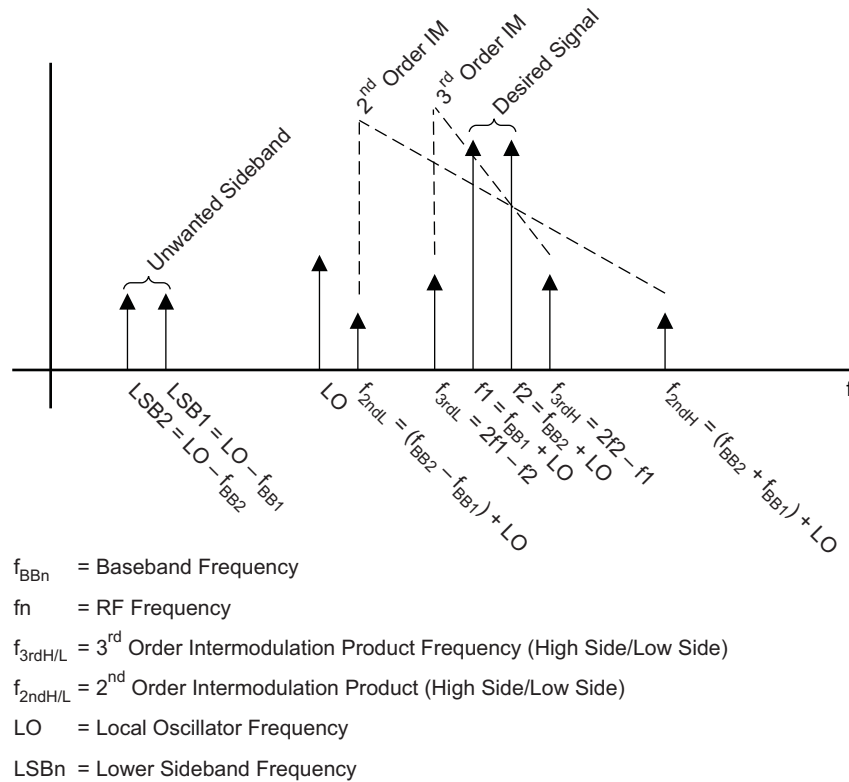

M0104-01

Figure 47. Graphical Illustration of Common Terms

REVISION HISTORY

NOTE: Page numbers for previous revisions may differ from page numbers in the current version.

Changes from Revision A (June, 2008) to Revision B	Page
• Added electrostatic discharge parameters to Absolute Maximum Ratings table	3
• Added <i>ESD Sensitivity</i> section	18

Changes from Original (March 2008) to Revision A	Page
• Added ACPR graph to Typical Characteristics based on customers' requests	16
• Added ACPR graph to Typical Characteristics based on customers' requests	16

PACKAGING INFORMATION

Orderable Device	Status (1)	Package Type	Package Drawing	Pins	Package Qty	Eco Plan (2)	Lead/Ball Finish (6)	MSL Peak Temp (3)	Op Temp (°C)	Device Marking (4/5)	Samples
TRF3703171RGER	ACTIVE	VQFN	RGE	24	3000	Green (RoHS & no Sb/Br)	NIPDAU	Level-2-260C-1 YEAR	-40 to 85	TRF37 0317	Samples
TRF3703171RGET	ACTIVE	VQFN	RGE	24	250	Green (RoHS & no Sb/Br)	NIPDAU	Level-2-260C-1 YEAR	-40 to 85	TRF37 0317	Samples

(1) The marketing status values are defined as follows:

ACTIVE: Product device recommended for new designs.

LIFEBUY: TI has announced that the device will be discontinued, and a lifetime-buy period is in effect.

NRND: Not recommended for new designs. Device is in production to support existing customers, but TI does not recommend using this part in a new design.

PREVIEW: Device has been announced but is not in production. Samples may or may not be available.

OBSOLETE: TI has discontinued the production of the device.

(2) **RoHS:** TI defines "RoHS" to mean semiconductor products that are compliant with the current EU RoHS requirements for all 10 RoHS substances, including the requirement that RoHS substance do not exceed 0.1% by weight in homogeneous materials. Where designed to be soldered at high temperatures, "RoHS" products are suitable for use in specified lead-free processes. TI may reference these types of products as "Pb-Free".

RoHS Exempt: TI defines "RoHS Exempt" to mean products that contain lead but are compliant with EU RoHS pursuant to a specific EU RoHS exemption.

Green: TI defines "Green" to mean the content of Chlorine (Cl) and Bromine (Br) based flame retardants meet JS709B low halogen requirements of <=1000ppm threshold. Antimony trioxide based flame retardants must also meet the <=1000ppm threshold requirement.

(3) MSL, Peak Temp. - The Moisture Sensitivity Level rating according to the JEDEC industry standard classifications, and peak solder temperature.

(4) There may be additional marking, which relates to the logo, the lot trace code information, or the environmental category on the device.

(5) Multiple Device Markings will be inside parentheses. Only one Device Marking contained in parentheses and separated by a "~" will appear on a device. If a line is indented then it is a continuation of the previous line and the two combined represent the entire Device Marking for that device.

(6) Lead/Ball Finish - Orderable Devices may have multiple material finish options. Finish options are separated by a vertical ruled line. Lead/Ball Finish values may wrap to two lines if the finish value exceeds the maximum column width.

Important Information and Disclaimer:The information provided on this page represents TI's knowledge and belief as of the date that it is provided. TI bases its knowledge and belief on information provided by third parties, and makes no representation or warranty as to the accuracy of such information. Efforts are underway to better integrate information from third parties. TI has taken and continues to take reasonable steps to provide representative and accurate information but may not have conducted destructive testing or chemical analysis on incoming materials and chemicals. TI and TI suppliers consider certain information to be proprietary, and thus CAS numbers and other limited information may not be available for release.

In no event shall TI's liability arising out of such information exceed the total purchase price of the TI part(s) at issue in this document sold by TI to Customer on an annual basis.

TAPE AND REEL INFORMATION



QUADRANT ASSIGNMENTS FOR PIN 1 ORIENTATION IN TAPE



*All dimensions are nominal

Device	Package Type	Package Drawing	Pins	SPQ	Reel Diameter (mm)	Reel Width W1 (mm)	A0 (mm)	B0 (mm)	K0 (mm)	P1 (mm)	W (mm)	Pin1 Quadrant
TRF370317IRGER	VQFN	RGE	24	3000	330.0	12.4	4.3	4.3	1.5	8.0	12.0	Q1
TRF370317IRGET	VQFN	RGE	24	250	330.0	12.4	4.3	4.3	1.5	8.0	12.0	Q1

TAPE AND REEL BOX DIMENSIONS

*All dimensions are nominal

Device	Package Type	Package Drawing	Pins	SPQ	Length (mm)	Width (mm)	Height (mm)
TRF370317IRGER	VQFN	RGE	24	3000	367.0	367.0	38.0
TRF370317IRGET	VQFN	RGE	24	250	367.0	367.0	38.0

GENERIC PACKAGE VIEW

RGE 24

VQFN - 1 mm max height

PLASTIC QUAD FLATPACK - NO LEAD



Images above are just a representation of the package family, actual package may vary.
Refer to the product data sheet for package details.

4204104/H

RGE0024B



PACKAGE OUTLINE

VQFN - 1 mm max height

PLASTIC QUAD FLATPACK - NO LEAD



4219013/A 05/2017

NOTES:

1. All linear dimensions are in millimeters. Any dimensions in parenthesis are for reference only. Dimensioning and tolerancing per ASME Y14.5M.
2. This drawing is subject to change without notice.
3. The package thermal pad must be soldered to the printed circuit board for thermal and mechanical performance.

EXAMPLE BOARD LAYOUT

RGE0024B

VQFN - 1 mm max height

PLASTIC QUAD FLATPACK - NO LEAD



LAND PATTERN EXAMPLE
EXPOSED METAL SHOWN
SCALE:15X



SOLDER MASK DETAILS

4219013/A 05/2017

NOTES: (continued)

4. This package is designed to be soldered to a thermal pad on the board. For more information, see Texas Instruments literature number SLUA271 (www.ti.com/lit/sl原因271).
5. Vias are optional depending on application, refer to device data sheet. If any vias are implemented, refer to their locations shown on this view. It is recommended that vias under paste be filled, plugged or tented.

EXAMPLE STENCIL DESIGN

RGE0024B

VQFN - 1 mm max height

PLASTIC QUAD FLATPACK - NO LEAD



SOLDER PASTE EXAMPLE
BASED ON 0.125 mm THICK STENCIL

EXPOSED PAD 25
78% PRINTED SOLDER COVERAGE BY AREA UNDER PACKAGE
SCALE:20X

4219013/A 05/2017

NOTES: (continued)

6. Laser cutting apertures with trapezoidal walls and rounded corners may offer better paste release. IPC-7525 may have alternate design recommendations.

IMPORTANT NOTICE AND DISCLAIMER

TI PROVIDES TECHNICAL AND RELIABILITY DATA (INCLUDING DATASHEETS), DESIGN RESOURCES (INCLUDING REFERENCE DESIGNS), APPLICATION OR OTHER DESIGN ADVICE, WEB TOOLS, SAFETY INFORMATION, AND OTHER RESOURCES "AS IS" AND WITH ALL FAULTS, AND DISCLAIMS ALL WARRANTIES, EXPRESS AND IMPLIED, INCLUDING WITHOUT LIMITATION ANY IMPLIED WARRANTIES OF MERCHANTABILITY, FITNESS FOR A PARTICULAR PURPOSE OR NON-INFRINGEMENT OF THIRD PARTY INTELLECTUAL PROPERTY RIGHTS.

These resources are intended for skilled developers designing with TI products. You are solely responsible for (1) selecting the appropriate TI products for your application, (2) designing, validating and testing your application, and (3) ensuring your application meets applicable standards, and any other safety, security, or other requirements. These resources are subject to change without notice. TI grants you permission to use these resources only for development of an application that uses the TI products described in the resource. Other reproduction and display of these resources is prohibited. No license is granted to any other TI intellectual property right or to any third party intellectual property right. TI disclaims responsibility for, and you will fully indemnify TI and its representatives against, any claims, damages, costs, losses, and liabilities arising out of your use of these resources.

TI's products are provided subject to TI's Terms of Sale (www.ti.com/legal/termsofsale.html) or other applicable terms available either on ti.com or provided in conjunction with such TI products. TI's provision of these resources does not expand or otherwise alter TI's applicable warranties or warranty disclaimers for TI products.

Mailing Address: Texas Instruments, Post Office Box 655303, Dallas, Texas 75265
Copyright © 2020, Texas Instruments Incorporated