



Z-Type Markers

Z-Type markers are individual push-on markers used to identify wires and small cables permanently. The markers are manufactured using PVC and designed with an expanding profile, enabling each marker to accommodate a wide range of wire/cable sizes.

Z-Type markers are a simple, cost-effective solution for many commercial wire identification applications. The markers are supplied either straight cut or chevron cut. The chevron cut option ensures the markers remain aligned. Standard Z-Type markers are yellow or white with black legends and can be supplied as loose pieces packed in boxes, or on reels. Color coded markers are also available. Suitable for industrial applications.

KEY FEATURES

- Self-extinguishing.
- Resistant to key Industrial fluids, including those used in Mass transit, Aviation and Military (defined by RW-2535).
- Nine sizes covering wire diameters from 1.5mm to 12.7mm (0.06 inches to 0.5 inches).

APPLICATIONS

- Pre-termination cable identification.
- Identification of small wires and cables.
- Applicator wands available for easy marker installation.
- Electrical and Electronic Equipment, Industrial

PART DESCRIPTION



TEMPERATURE RATING

Operating Temperature Range -45°C to 70°C (-40°F to 158°F)

ENVIRONMENTAL

Information and a downloadable declaration covering RoHS and REACH compliance can be found at the 'TE Product Compliance Support Centre':

<http://www.te.com/en/resources/product-compliance.html>

SPECIFICATIONS / APPROVALS

TE Connectivity Standard

- RW-2535

Industrial

- BS 6746C:1993 Colour chart for insulation and sheath of electric cables
- IEC 60304 Standard Colours for Insulation for Low Frequency Cables and Wires

Where possible, TE have tested product as a finished item, including the print. Operational tests are followed by an assessment of mark adherence to validate fit form and function. Further details can be found in TE standard RW-2535.

Z-Type Markers

AVAILABLE FORMATS

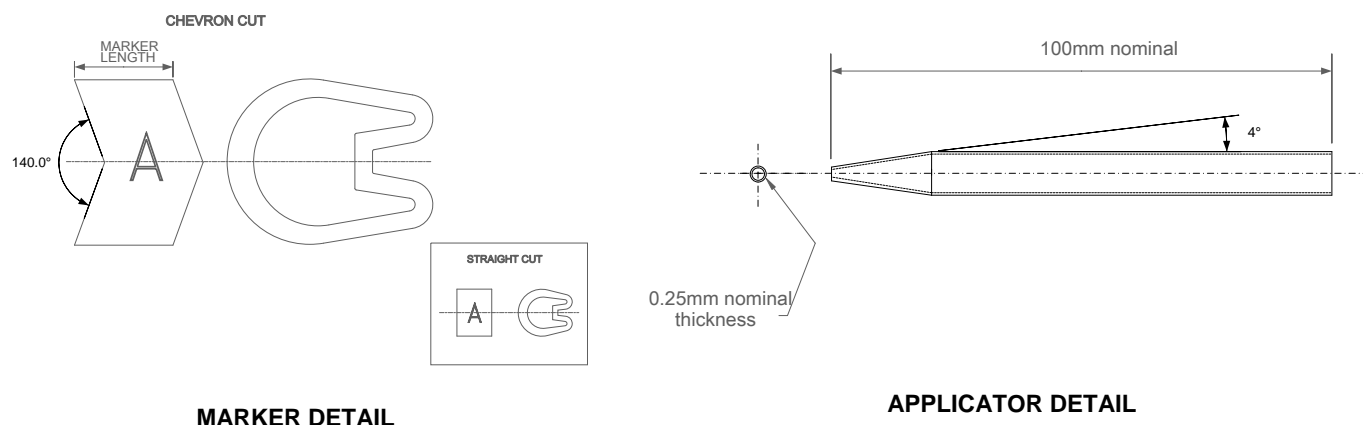

ORDERING INFORMATION

Order Code Straight cut	Order Code Chevron cut	Marker size	Recommended cable diameter		Marker length		Applicator size code	Pack Quantity	Applicator order code
			mm	inches	mm	inches			
0580	1151	5	1.5 – 2.0	0.06 – 0.08	4.5	0.177	-	1000	-
0581	1152	7	2.0 – 3.2	0.08 – 0.13	4.5	0.177	1	1000	12510000
0615	1153	9	2.5 – 4.0	0.10 – 0.16	4.5	0.177	2	1000	12520000
0616	1154	11	2.9 – 4.7	0.11 – 0.19	4.5	0.177	3	1000	12530000
0617	1155	13	3.4 – 5.7	0.13 – 0.22	4.5	0.177	4	1000	12540000
0618	1156	15	3.8 – 6.3	0.15 – 0.25	4.5	0.177	5	1000	12550000
0620	1157	18	4.3 – 6.9	0.17 – 0.27	4.5	0.177	6	500	12560000
0622	1158	23	5.5 – 8.9	0.22 – 0.35	6.0	0.236	-	500	-
0624	1159	35	7.9 – 12.7	0.31 – 0.50	6.0	0.236	-	250	-

PACKAGING CODE

1	Box	3	Reel
---	-----	---	------

PACKAGING OPTIONS (CHEVRON AND STRAIGHT CUT)

White marker with black legend	Boxes, reels
Yellow marker with black legend	Reels
Color coded	Boxes

COLOR CODE

Code	Marker color	Ink color	Code	Marker color	Ink color	Code	Marker color	Ink color
0	Black	White	4	Yellow	Black	8	Grey	Black
1	Brown	White	5	Green	Black	9	White	Black
2	Red	Black	6	Blue	Black			
3	Orange	Black	7	Violet	Black			

Z-Type Markers

LEGEND CODE

Legend	Code	Legend	Code	Legend	Code
0	00	J	19	/	38
1	01	K	20	~	39
2	02	L	21	Earth	40
3	03	M	22)	41
4	04	N	23	Blank	42
5	05	O	24	:	43
6	06	P	25	,	44
7	07	Q	26	<	45
8	08	R	27	>	46
9	09	S	28	=	47
A	10	T	29	.	48
B	11	U	30		
C	12	V	31		
D	13	W	32		
E	14	X	33		
F	15	Y	34		
G	16	Z	35		
H	17	+	36		
I	18	-	37		

Order example 06161400: Z-type marker, size 11, yellow, black mark, character O, boxed

While TE has made every reasonable effort to ensure the accuracy of the information in this document, TE does not guarantee that it is error-free, nor does TE make any other representation, warranty or guarantee that the information is accurate, correct, reliable or current. TE reserves the right to make any adjustments to the information contained herein at any time without notice. TE expressly disclaims all implied warranties regarding the information contained herein, including, but not limited to, any implied warranties of merchantability or fitness for a particular purpose. The dimensions in this document are for reference purposes only and are subject to change without notice. Specifications are subject to change without notice. Consult TE for the latest dimensions and design specifications.

*Trademark. TE Connectivity, TE connectivity (logo), and TE (logo) are trademarks. Other logos, product and/or company names may be trademarks of their respective owners.

Mouser Electronics

Authorized Distributor

Click to View Pricing, Inventory, Delivery & Lifecycle Information:

[TE Connectivity:](#)

[EC0248-000](#)