

# Peripheral Devices







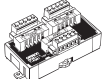
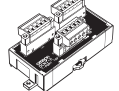
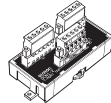
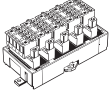
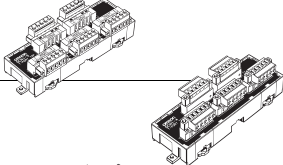
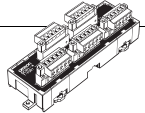
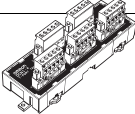
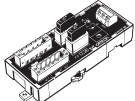

## General-purpose Peripheral Devices

### Peripheral Devices for DeviceNet Communications

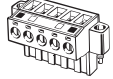





#### Ordering Information

##### ● General-purpose Models

Product	Appearance	Model	Specifications	
T-branch Tap for 1 branch line		<b>DCN1-1NC</b>	Cable wiring direction: Toward top Cable lock direction: From top Connector screw direction: From top	Provided with 3 parallel connectors with clamps (XW4G-05C1-H1-D), standard terminating resistor
		<b>DCN1-1C</b>	Cable wiring direction: Toward side Cable screw direction: From top Connector screw direction: From side	Provided with 3 parallel connectors with screws (XW4B-05C1-H1-D), standard terminating resistor
		<b>DCN1-2C</b>	Cable wiring direction: Toward top Cable screw direction: From side Connector screw direction: From top	
		<b>DCN1-2R</b>	Cable wiring direction: Toward side Cable screw direction: From top Connector screw direction: From top	Provided with 3 orthogonal connectors with screws (XW4B-05C1-VIR-D), standard terminating resistor
T-branch Tap for 3 branch lines		<b>DCN1-3NC</b>	Cable wiring direction: Toward top Cable lock direction: From top Connector screw direction: From top	Provided with 5 parallel clamp connectors with screws (XW4G-05C1-H1-D), standard terminating resistor
		<b>DCN1-3C</b>	Cable wiring direction: Toward side Cable screw direction: From top Connector screw direction: From side	Provided with 5 parallel connectors with screws (XW4B-05C1-H1-D), standard terminating resistor
		<b>DCN1-4C</b>	Cable wiring direction: Toward top Cable screw direction: From side Connector screw direction: From top	
	<b>DCN1-4R</b>	Cable wiring direction: Toward side Cable screw direction: From top Connector screw direction: From top	Provided with 5 orthogonal clamp connectors with screws (XW4B-05C1-VIR-D), standard terminating resistor	
Power Supply Tap		<b>DCN1-1P</b>	Tap provided with 2 connectors, standard terminating resistor, and fuse	

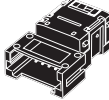
Product		Appearance	Model	Specifications
Connectors			XW4G-05C1-H1-D	Parallel clamp connector with screws Connector insertion and wiring both performed horizontally.
			XW4G-05C4-TF-D	Parallel multi-branching clamp connector with screws Connector insertion and wiring performed in same direction.
			XW4B-05C1-H1-D	Parallel connector with screws Connector insertion and wiring performed in same direction.
			XW4B-05C4-T-D	Parallel, screw-less, multi-branching connector Connector insertion and wiring performed in same direction.
			XW4B-05C4-TF-D	Parallel, multi-branching connector with screws Connector insertion and wiring performed in same direction.
			XW4B-05C1-VIR-D	Orthogonal connector with screws Connector insertion and wiring performed at a right angle.
DeviceNet Standard Cables	Thin Cables		DCA1-5C10(-B)	Outer diameter: 7.00 mm Length: 100 m DCA1-5C10-B: Cable color: Blue DCA1-5C10: Cable color: Gray
	Thick Cables		DCA2-5C10(-B)	Outer diameter: 11.6 mm Length: 100 m DCA2-5C10-B: Cable color: Blue DCA2-5C10: Cable color: Gray
Terminal-block Terminator			DRS1-T	Resistance of 121 Ω

● Peripheral Devices for Flat Cables

Product	Appearance	Model	Specifications
Connector for Flat Cable		DCN4-SF4D	Connector with lock screws for crimping flat cable
Conversion Connector for Standard Thin Cable and Flat Cable		DCN4-BR4D	Used as a set with a DCN4-TR4 when Thin Cable is branched on a branch line.
Power Supply Terminal Block with Terminating Resistance for Flat Cable		DCN4-TP4D	Can be used to supply communications power from terminals when Flat Cable is used.
Flat Connector Socket		DCN4-TR4	Used as a set with a DCN4-BR4 Flat Connector Plug in the following applications. <ul style="list-style-type: none"> <li>• Extending the trunk line</li> <li>• T-branching the trunk line into branch lines</li> </ul>
			Used alone in the following applications. <ul style="list-style-type: none"> <li>• Connecting a DCN4-TM4 Terminating Resistor to the trunk line</li> </ul>
Flat Connector Plug		DCN4-BR4	Used as a set with a DCN4-TR4 Flat Connector Socket in the following applications. <ul style="list-style-type: none"> <li>• Extending the trunk line</li> <li>• T-branching the trunk line into branch lines</li> </ul>
Terminating Resistor		DCN4-TM4	Connector terminating resistor for flat cable. Attached to the DCN4-TR4 Flat Connector Socket at the end of the trunk line.
Flat Cable		DCA4-4F10	Four-core flat cable (UL 2555) Length: 100 m Conductor diameters: 0.75 mm <sup>2</sup> x 2, 0.5 mm <sup>2</sup> x 2
Simple Manual Crimp Tool		DWT-A01	Crimping tool for DCN4-TR4 Flat Connector Socket or DCN4-BR4 Flat Connector Plug.

Specifications

● General-purpose Models (T-branch Taps)

<b>Rated current</b>	Between main lines: 8 A (power supply line) and 2 A (signal line)
	Between main and branch lines: 3 A (power supply line) and 1 A (signal line)
<b>Insulation resistance</b>	100 MΩ min. (at 500 VDC)
<b>Dielectric strength</b>	500 VAC for 1 min, leakage current: 1 mA max.
<b>Ambient operating temperature</b>	0°C to 55°C

## Dimensions

### ● General-purpose Models

#### T-branch Tap for 1 branch line DCN1-1NC (With Three Branching Connectors)

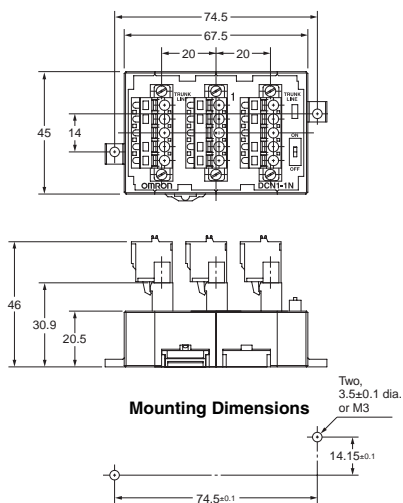
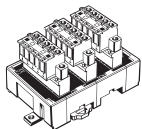

#### Internal Circuit

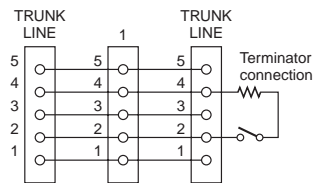

Terminal No.	Name
1	V-
2	CAN L
3	DRAIN
4	CAN H
5	V+

#### T-branch Tap for 1 branch line DCN1-1C (With Three Branching Connectors)

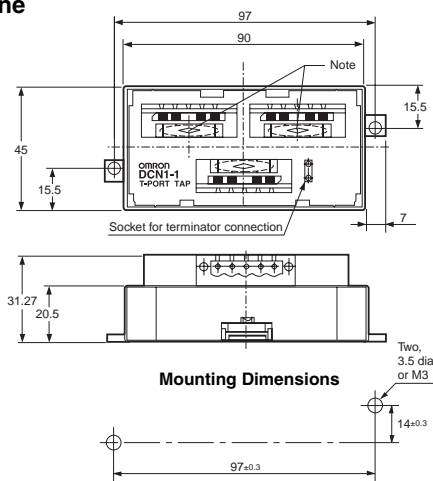
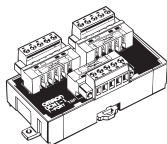

#### Internal Circuit

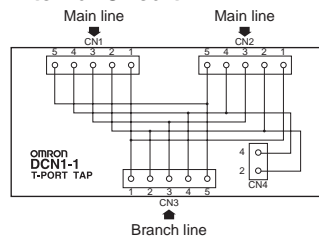

Terminal No.	Name
1	V-
2	CAN L
3	DRAIN
4	CAN H
5	V+

**Note:** When connecting a branch line to the main line, connect the main line to the connector marked with an asterisk because the resistance between the asterisks is minimal.

#### T-branch Tap for 3 branch lines DCN1-3NC (With Five Branching Connectors)

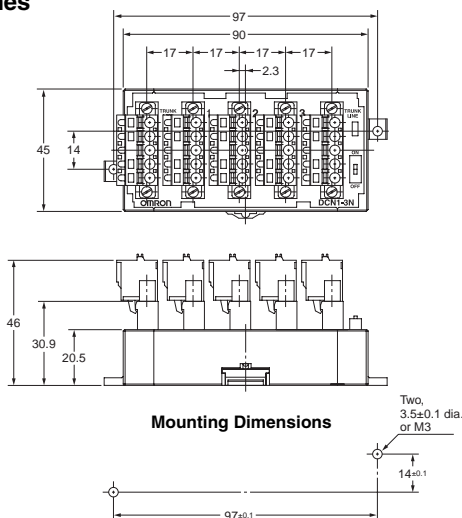
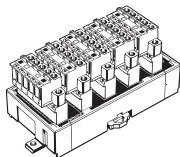

#### Internal Circuit

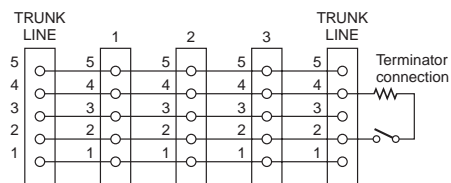

Terminal No.	Name
1	V-
2	CAN L
3	DRAIN
4	CAN H
5	V+

**T-branch Tap for 3 branch lines  
DCN1-3C  
(With Five Branching  
Connectors)**

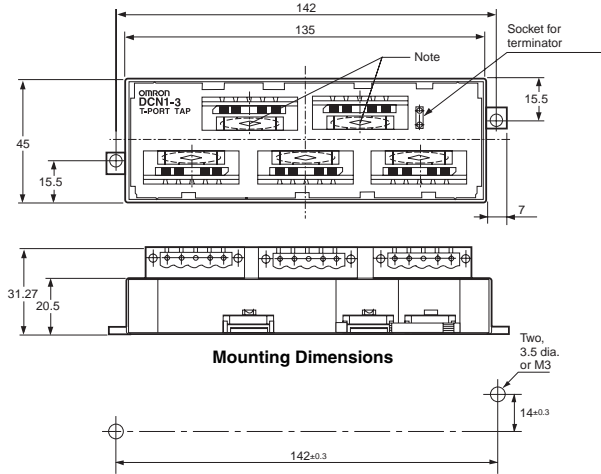
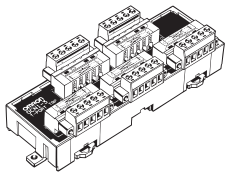

**Mounting Dimensions**

**Note:** When connecting a branch line to the main line, connect the main line to the connector marked with an asterisk because the resistance between the asterisked portion is minimal.

**Internal Circuit**

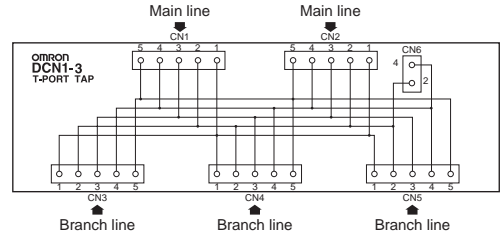

Terminal No.	Name
1	V-
2	CAN L
3	DRAIN
4	CAN H
5	V+

**Power Supply Tap  
DCN1-1P  
(With Two Branching  
Connectors)**

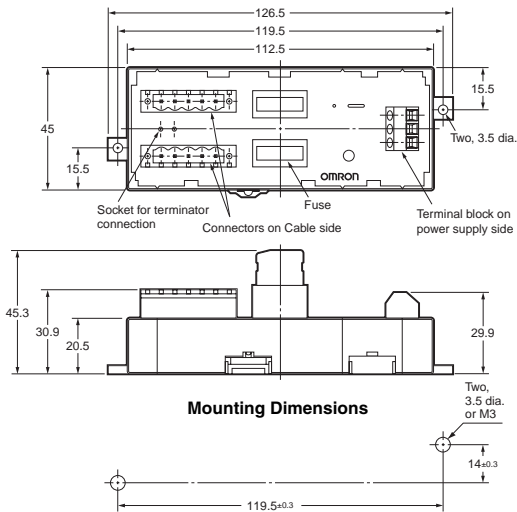
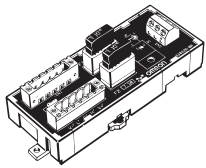

**Mounting Dimensions**

**Internal Circuit**

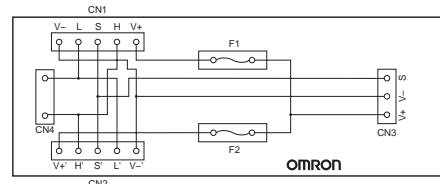

Terminal No.	Name
V-	V-
L	CAN L
S	DRAIN
H	CAN H
V+	V+

**DRS1-T  
(Terminal-block Terminator)**

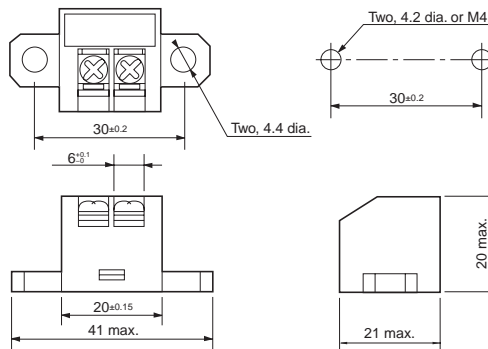
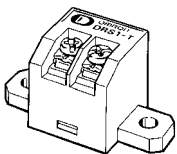

**Mounting Dimensions**

● Flat Cable

Connector for Flat Cable  
DCN4-SF4D

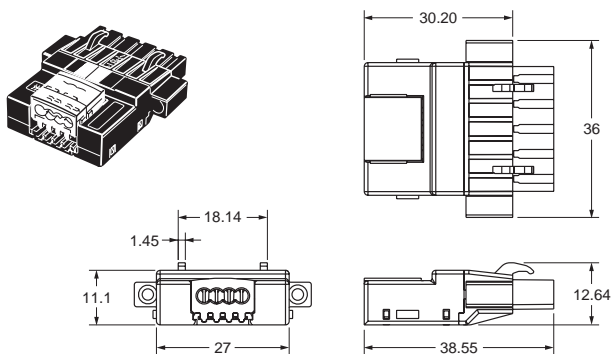

Conversion Connector for Standard Thin Cable and Flat Cable  
DCN4-BR4D

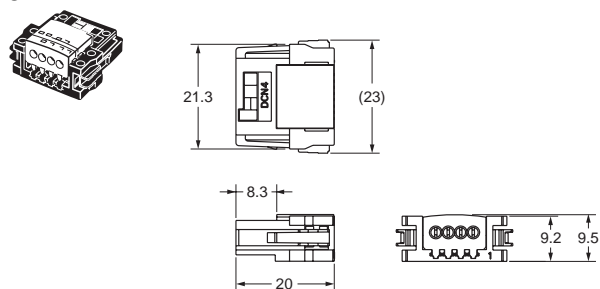

Power Supply Terminal Block with Terminating Resistance for Flat Cable  
DCN4-TP4D

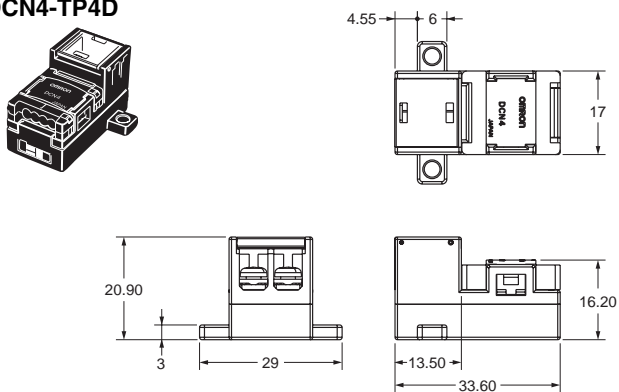

Flat Connector Socket  
DCN4-TR4

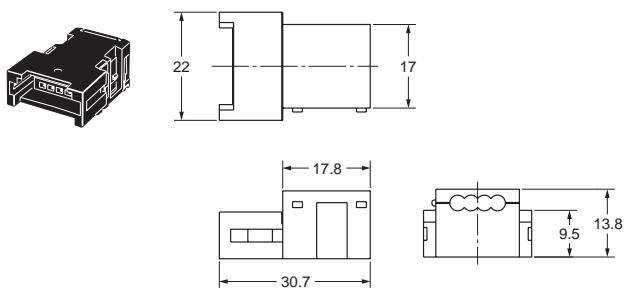

Flat Connector Plug  
DCN4-BR4

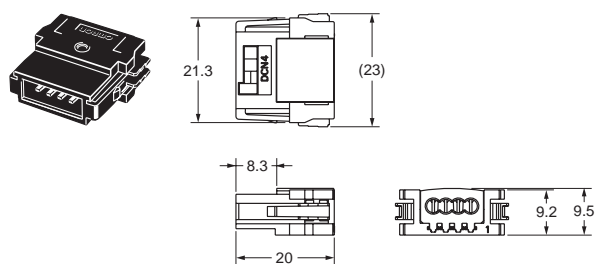

**I/O Peripheral Devices**

**■ I/O Connectors for Connector Terminals**

**● MIL Connectors**

**Applicable Connectors**

Type	Model	Remarks
Flat Cable Pressure-welded Connectors	<b>XG4M-4030-T</b>	
Pressure-welded Connectors with Loose Wires	Socket	<b>XG5M-4032-N</b>
		<b>XG5M-4035-N</b>
	Semicover	<b>XG5S-2001</b>
	Hood Cover *	<b>XG5S-4022</b>

\* DeviceNet connectors for multi-drop wiring cannot be used with the Hood Cover.

**Cable Models**

Type	Model	Connected device	Applicable models
Cable with Connectors (1:2)	<b>G79-I□□-□□-D1</b>	G7TC/G70D/G70A	DRT2-ID32ML
	<b>G79-M□□-□□-D1</b>		DRT2-MD32ML
	<b>G79-O□□-□□-D1</b>		DRT2-OD32ML/DRT1-OD32ML-1
	<b>G79-I□□-□□-D2</b>		DRT2-ID32ML-1
	<b>G79-M□□-□□-D2</b>		DRT2-MD32ML-1
Cable with Connector (1:1)	<b>XW2Z-C□□K</b>		
Cable with Loose Wires with Crimp Terminals	<b>G79-Y□00C-D1</b>	--	All models
Cable with Loose Wires	<b>G79-A□00C-D1</b>		

**Applicable Cables with Connectors**

**● Cables with Connectors (1-to-2 Connection)/G79-□□-□-D□**

Appearance	Cable length (mm)	Cable length (mm)		Model
		(A)	(B)	
	500	250	<b>G79-I50-25-D1</b>	
	750	500	<b>G79-I75-50-D1</b>	
	500	250	<b>G79-O50-25-D1</b>	
	750	500	<b>G79-O75-50-D1</b>	
	500	250	<b>G79-M50-25-D1</b>	
	750	500	<b>G79-M75-50-D1</b>	
	500	250	<b>G79-I50-25-D2</b>	
	750	500	<b>G79-I75-50-D2</b>	
	500	250	<b>G79-M50-25-D2</b>	
	750	500	<b>G79-M75-50-D2</b>	

**● Cables with Connectors (1-to-1 Connection)/XW2Z-C□□K**

Appearance	Cable length (mm)	Model
	250	<b>XW2Z-C25K</b>
	500	<b>XW2Z-C50K</b>

**● Cables with Crimp Terminals (at the End of Loose Wires)/G79-Y□C-D1**

Appearance	Cable length (mm)	Model
	1,000	<b>G79-Y100C-D1</b>
	2,000	<b>G79-Y200C-D1</b>
	5,000	<b>G79-Y500C-D1</b>

● Cables with Loose Wires/G79-A□C

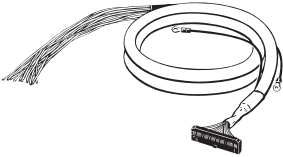
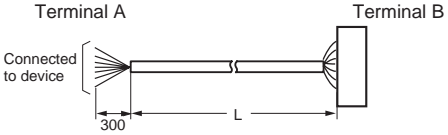
Appearance	Cable length (mm)	Model
		2,000 <b>G79-A200C-D1</b>
		5,000 <b>G79-A500C-D1</b>



## ■ I/O Connectors for MULTIPLE I/O TERMINALS



### Applicable Connectors

Type		Model	Remark	Connectable model		
Molex connector	Crimped terminals	Housing	50-57-9403	Corresponding to 24 to 30 AWG	Digital I/O Units GT1-ID16MX(-1)/GT1-OD16MX(-1)	
		Chain terminal	16-02-0069			Corresponding to 22 to 24 AWG
		Loose terminal	16-02-0096			Corresponding to 24 to 30 AWG
			16-02-0102			Corresponding to 22 to 24 AWG
		Press-fit tool	57036-5000			Corresponding to 22 to 26 AWG
		57037-5000	Corresponding to 24to 30 AWG	Analog I/O Units GT1-AD08MX/GT1-DA04MX		
Fujitsu connector (16 points)	Soldered terminals	FCN361J024-AU				
	Pressure-welded terminals	FCN367J024-AU/F				
	Crimped terminals	FCN363J024-AU				
Fujitsu connector (32 points)	Soldered terminals	FCN361J040-AU		Digital I/O Units GT1-ID32ML(-1)/GT1-OD32ML(-1)		
	Pressure-welded terminals	FCN367J040-AU/F				
	Crimped terminals	FCN363J040-AU				
OMRON D-sub connector	Pulg	XM2A-2501		Digital I/O Units GT1-ID16DS(-1)/GT1-OD16DS(-1)		
	Hood	XM2S-2513	#4-40UNC inch screws			

### Applicable Cables with Connectors (Fujitsu Connectors)

I/O classification	Model	Connectable model
Digital input, 16 points	XW2Z-□□□A	Digital I/O Units GT1-ID16ML(-1)
	G79-□C	
Digital output, 16 points	XW2Z-□□□A	Digital I/O Units GT1-OD16ML(-1)
	G79-□C	
Digital input, 32 points	XW2Z-□□□B	Digital I/O Units GT1-ID32ML(-1)
	G79-□C□	
Digital output, 32 points	XW2Z-□□□B	Digital I/O Units GT1-OD32ML(-1)
	G79-□C□	

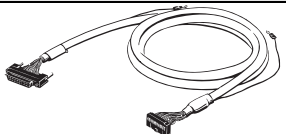
#### ● Cables with Connectors (1-to1 Connection)/G79-□C For Digital Input/Output (16 Points)

Appearance	Cable length (mm)	Model
		1,000
		1,500
		2,000
		3,000
		5,000

#### ● Cables with Connectors (1-to-2 Connection)/G79-□□C-□, G79-□□C-□ For Digital Input/Output (32 Points)

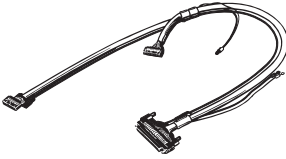
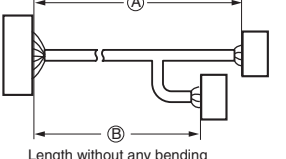
Appearance	Cable length (mm)		Model		
	①	②	Input	Output	
		1,000	750	G79-I100C-75	G79-O100C-75
		1,500	1,250	G79-I150C-125	G79-O150C-125
		2,000	1,750	G79-I200C-175	G79-O200C-175
		3,000	2,750	G79-I300C-275	G79-O300C-275
		5,000	4,750	G79-I500C-475	G79-O500C-475

#### For Digital Input/Output (16 Points)

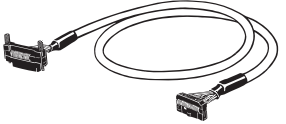
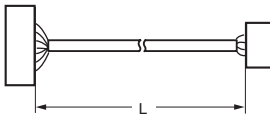
Appearance	Cable length (mm)	Model
		500
		1,000
		1,500
		2,000
		3,000
		5,000

#### For Digital Input/Output (32 Points)

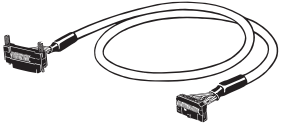
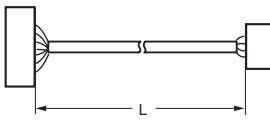
Appearance	Cable length (mm)	Model
		500
		1,000
		1,500
		2,000
		3,000
		5,000

## I/O Connector for Programmable Slaves

### Applicable Connector Terminal Conversion Units

Applicable cable	Connected product	Remarks
XW2Z-□□□A	XW2D-20G6	Slim type (with M3 screw terminals)
	XW2B-20G4	Flat cable connectors (with M3 terminal screws for flat-blade screwdriver)

### Applicable Cables with Connectors

● Cables with Connectors/XW2Z  
For Digital Input/Output (16 Points)

Appearance	Cable length (mm)	Model
	500	XW2Z-050A
	1,000	XW2Z-100A
	1,500	XW2Z-150A
	2,000	XW2Z-200A
	3,000	XW2Z-300A
	5,000	XW2Z-500A

# Peripheral Devices for Environment-resistive Slaves



## Peripheral Devices for DeviceNet Communications

### Ordering Information

● Environment-resistive Connection Products (for Thin Cable, M12 Micro Connectors)

Product	Appearance	Model	Specifications
Sealed Assembling-type Connector (male)		XS2G-D5S7	For communications (plug)
Sealed Assembling-type Connector (female)		XS2C-D5S7	For communications (socket)
Sealed T-branch Connector		DCN2-1	For 1 branch line
Sealed Connector with Terminating Resistor		DRS2-1	Plug
		DRS2-2	Socket
Cables with Sealed Connectors		DCA1-5CNC5W1	Length (L): 0.5 m
		DCA1-5CN01W1	Length (L): 1 m
		DCA1-5CN02W1	Length (L): 2 m
		DCA1-5CN03W1	Length (L): 3 m
		DCA1-5CN05W1	Length (L): 5 m
		DCA1-5CN10W1	Length (L): 10 m
		DCA1-5CNC5F1	Length (L): 0.5 m
		DCA1-5CN01F1	Length (L): 1 m
		DCA1-5CN02F1	Length (L): 2 m
		DCA1-5CN03F1	Length (L): 3 m
		DCA1-5CN05F1	Length (L): 5 m
		DCA1-5CN10F1	Length (L): 10 m
		DCA1-5CNC5H1	Length (L): 0.5 m
		DCA1-5CN01H1	Length (L): 1 m
		DCA1-5CN02H1	Length (L): 2 m
Shielded Panel-mounting Connectors (female)		DCA1-5CNC5P1	Panel-mounting connector (socket) with 0.5-m cable
		XS2P-D522-2	Panel-mounting connector socket
Shielded Panel-mounting Connectors (male)		DCA1-5CNC5M1	Panel-mounting connector (plug) with 0.5-m cable
		XS2M-D524-4	Panel-mounting connector (plug) with solder-cup terminals
Waterproof cover (for socket)		XS2Z-22	Used to cover an unused connector section
Dust cover (for socket)		XS2Z-15	

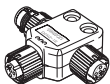
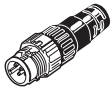
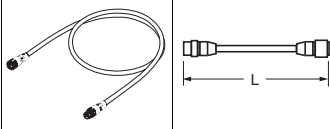
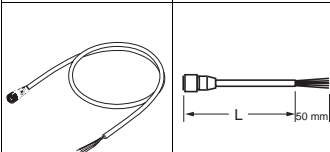
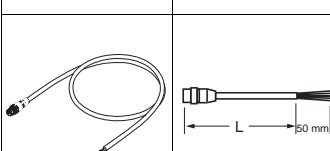
● Environment-resistive Models (for Thin Wires and M12 Micro Connectors) 

Product	Appearance	Model	Specifications
Sealed T-branch Connector		DCN2-1S	For 1 branch line
Sealed Assembling type Connector (female)		DRS2-1S	Plug
		DRS2-2S	Socket
Connectors with Shielded Cables		DCA1-5CSC5W1	Length (L): 0.5 m
		DCA1-5CS01W1	Length (L): 1 m
		DCA1-5CS02W1	Length (L): 2 m
		DCA1-5CS03W1	Length (L): 3 m
		DCA1-5CS05W1	Length (L): 5 m
		DCA1-5CS10W1	Length (L): 10 m
		DCA1-5CSC5F1	Length (L): 0.5 m
		DCA1-5CS01F1	Length (L): 1 m
		DCA1-5CS02F1	Length (L): 2 m
		DCA1-5CS03F1	Length (L): 3 m
		DCA1-5CS05F1	Length (L): 5 m
		DCA1-5CS10F1	Length (L): 10 m
		DCA1-5CSC5H1	Length (L): 0.5 m
		DCA1-5CS01H1	Length (L): 1 m
		DCA1-5CS02H1	Length (L): 2 m
		DCA1-5CS03H1	Length (L): 3 m
		DCA1-5CS05H1	Length (L): 5 m
		DCA1-5CS10H1	Length (L): 10 m
Shielded Branch Relay Box		DCN2-S4C5H1	4 ports, 0.5-m cable
		DCN2-S8C5H1	8 ports, 0.5-m cable

● Environment-resistive Models for Thick Wires with 7/8-16UN Mini Connectors

Product	Appearance	Model	Specifications
Sealed T-branch Connector		DCN3-11	T-branch Connector
		DCN3-12	T-branch Connector (Branch connector is M12.)
Sealed Connector with Terminating Resistor		DRS3-1	Plug
Cables with Sealed Connectors		DCA2-5CN01W1	Length (L): 1 m
		DCA2-5CN02W1	Length (L): 2 m
		DCA2-5CN05W1	Length (L): 5 m
		DCA2-5CN10W1	Length (L): 10 m
		DCA2-5CN01F1	Length (L): 1 m
		DCA2-5CN02F1	Length (L): 2 m
		DCA2-5CN05F1	Length (L): 5 m
		DCA2-5CN10F1	Length (L): 10 m
		DCA2-5CN01H1	Length (L): 1 m
		DCA2-5CN02H1	Length (L): 2 m
		DCA2-5CN05H1	Length (L): 5 m
		DCA2-5CN10H1	Length (L): 10 m
		DCA1-5CN01W5	Length (L): 1 m
		DCA1-5CN02W5	Length (L): 2 m
		DCA1-5CN05W5	Length (L): 5 m
		DCA1-5CN10W5	Length (L): 10 m
Panel-mounting Connector (female)		DCA2-5CNC5P1	Panel-mounting connector (socket) with 0.5-m cable
Panel-mounting Connector (male)		DCA2-5CNC5M1	Panel-mounting connector (plug) with 0.5-m cable
Panel-mounting Connector (male)		XS4M-D521-1	Panel-mounting connector (plug) DIP terminals
Waterproof Cap (for Plug)	-	XS4Z-11	Used to cover an unused connector section.
Waterproof Cap (for Socket)	-	XS4Z-12	

## Specifications

### ● Environment-resistive Connection Products (for Thin Cable, M12 Micro Connectors)

Type	Connectors with Cables DCA1-5CN□□□1	T-branch Connector DCN2-1	Assembling-type Connector XS2□-D5S7	Connectors with Terminating Resistor DRS2-□
Rated current	3 A			
Rated voltage	125 VDC			
Contact resistance (connector)	40 mΩ max. (at 20 mVDC max. and 100 mA max.)			
Insulation resistance	1,000 MΩ min. (at 500 VDC)			
Dielectric strength (connector)	1,500 VAC for 60 seconds (leakage current: 1 mA max.)			
Ambient operating temperature	-20°C to 65°C			
Storage temperature range	-25°C to 70°C			
Degree of protection	IEC IP67			
Insertion durability	200 times			
Cable strength	98 N for 15 s	--		
Vibration resistance	No current interruptions of more than 1 μs while performing simple vibrations at either 10 to 500 Hz with 1.52-mm full amplitude or at acceleration 100 m/s <sup>2</sup> , whichever is smaller			

### ● Environment-resistive Models (for Thin Wires and M12 Micro Connectors)

Type	Connectors with Cables DCA1-5CS□□□1	T-branch Connector DCN2-1S	Connectors with Terminating Resistor DRS2-□S	Branch Relay Box DCN2-S□C5H
Rated current	3 A			
Rated voltage	125 VDC			
Contact resistance (connector)	40 mΩ max. (at 20 mVDC max. and 100 mA max.)			
Insulation resistance	1,000 MΩ min. (at 500 VDC)			
Dielectric strength (connector)	1,500 VAC for 60 seconds (leakage current: 1 mA max.)			1,000 VAC for 60 seconds
Ambient operating temperature	-20°C to 65°C			
Storage temperature range	-25°C to 70°C			
Degree of protection	IEC IP67			
Insertion durability	200 times			
Cable strength	98 N for 15 s	--		
Vibration resistance	No current interruptions of more than 1 μs while performing simple vibrations at either 10 to 500 Hz with 1.52-mm full amplitude or at acceleration 100 m/s <sup>2</sup> , whichever is smaller			
Lock strength	Pulling: 100 N/15 s, Rotating: 1 N·m/15 s			
Lock force	0.1 to 0.25 N·m			

### ● Environment-resistive Models for Thick Wires with 7/8-16UN Mini Connectors

Type	Connectors with Thick Cables DCA2-5CN□□□1	Connectors with Thin Cables DCA1-5CN□□□W5	T-branch Connector DCN3-11	T-branch Connector DCN3-12	Connectors with Terminating Resistor DRS3-1	Panel Mounting Connector DCA2-5CNC5P1	Panel Mounting Connector XS4M-D521-1
Rated current	8 A	3 A	8 A	3 A *	8 A		
Rated voltage	125 VDC						
Contact resistance (connector)	30 mΩ max. (at 20 mVDC max. and 100 mA max.)						
Insulation resistance	1,000 MΩ min. (at 500 VDC)						
Dielectric strength (connector)	1,500 VAC for 60 seconds (leakage current: 1 mA max.)						
Ambient operating temperature	-20°C to 65°C						
Storage temperature range	-25°C to 70°C						
Degree of protection	IEC IP67						
Insertion durability	200 times						
Cable strength	98 N for 15 s			--		98 N for 15 s	--
Vibration resistance	No current interruptions of more than 1 μs while performing simple vibrations at either 10 to 500 Hz with 1.52-mm full amplitude or at acceleration 100 m/s <sup>2</sup> , whichever is smaller						

\* The rated current between thick wires is 8 A.

## Dimensions

### ● Environment-resistive Connection Products (for Thin Cable, M12 Micro Connectors)

#### Cables with Connectors on Both Ends DCA1-5CN□□W1

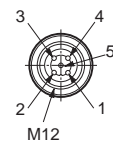
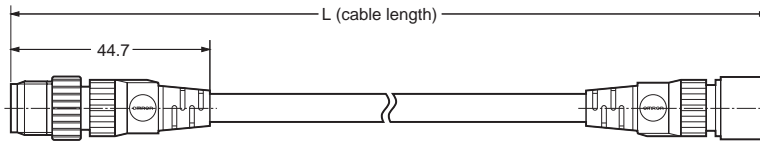
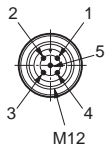
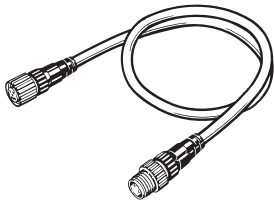

#### Wiring

Terminal No.	Color	Name
1	-	DRAIN
2	Red	V+
3	Black	V-
4	White	CAN H
5	Blue	CAN L

#### Cables with Connector on Single End (Socket) DCA1-5CN□□F1

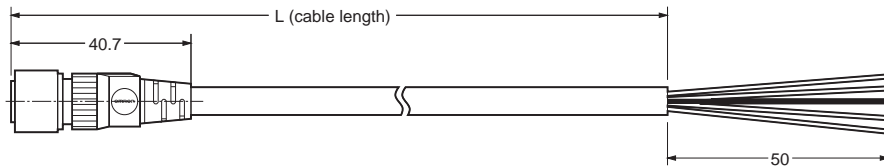
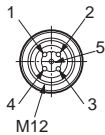
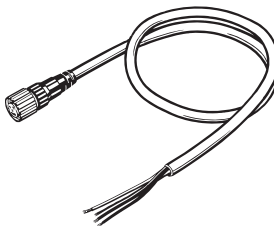

#### Wiring

Terminal No.	Color	Name
1	-	DRAIN
2	Red	V+
3	Black	V-
4	White	CAN H
5	Blue	CAN L

#### Cables with Connector on Single End (Plug) DCA1-5CN□□H1

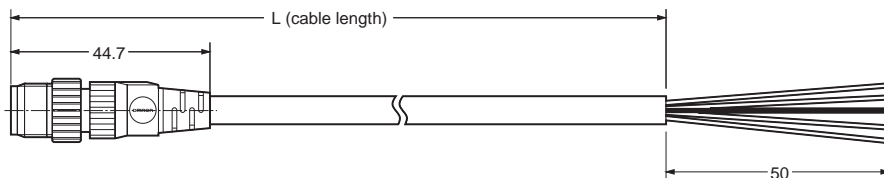
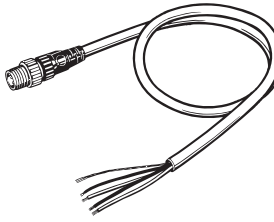

#### Wiring

Terminal No.	Color	Name
1	-	DRAIN
2	Red	V+
3	Black	V-
4	White	CAN H
5	Blue	CAN L

#### T-branch Connector DCN2-1

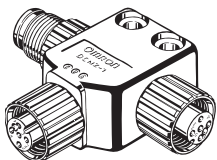

#### Connections Diagram

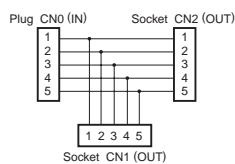

#### Wiring

Terminal No.	Name
1	SHIELD
2	V+
3	V-
4	CAN H
5	CAN L

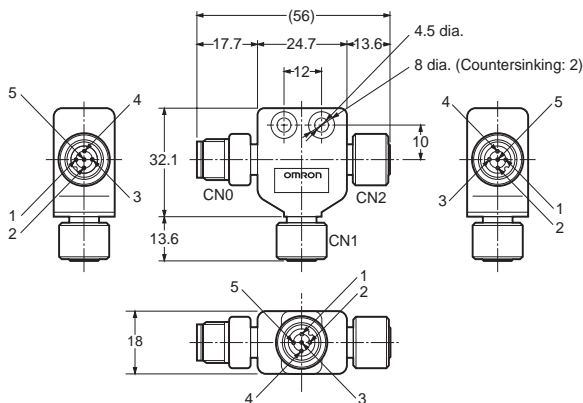

#### Connectors with Terminating Resistance

##### DRS2-1 (Plug) DRS2-2 (Socket)



#### Wiring

Terminal No.	Name
1	DRAIN : NC
2	V+ : NC
3	V- : NC
4	CAN H : $\sim 121 \Omega$
5	CAN L : $\sim 121 \Omega$

**Note:** Terminating resistance (121  $\Omega$ ) is connected between terminals 4 and 5.

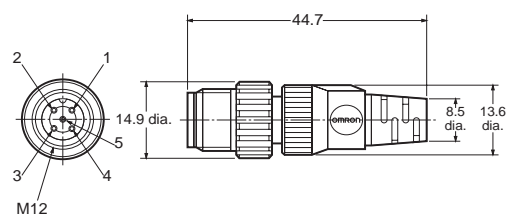

**Note:** The diagram shows the DRS2-1 (plug).

**Panel-mounting Connector (Socket) with 0.5 m Cable**  
**DCA1-5CNC5P1**

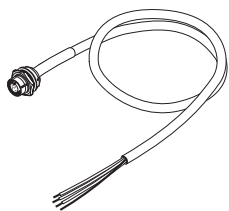

**Wiring**

Terminal No.	Color	Name
1	-	DRAIN
2	Red	V+
3	Black	V-
4	White	CAN H
5	Blue	CAN L

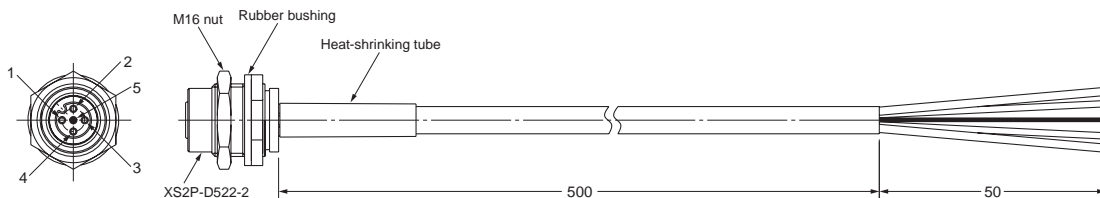

**Panel-mounting Connector (Socket), Solder-cup Terminals**  
**XS2P-D522-2**



**Panel Cutout Dimensions**

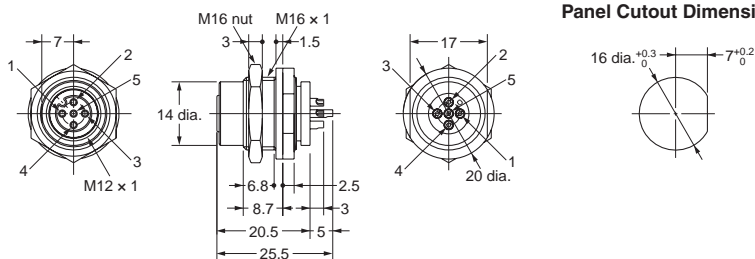

**Panel-mounting Connector (Plug) with 0.5 m Cable**  
**DCA1-5CNC5M1**

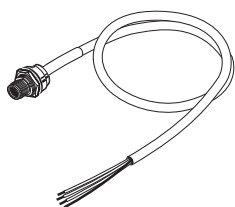

**Wiring**

Terminal No.	Color	Name
1	-	DRAIN
2	Red	V+
3	Black	V-
4	White	CAN H
5	Blue	CAN L

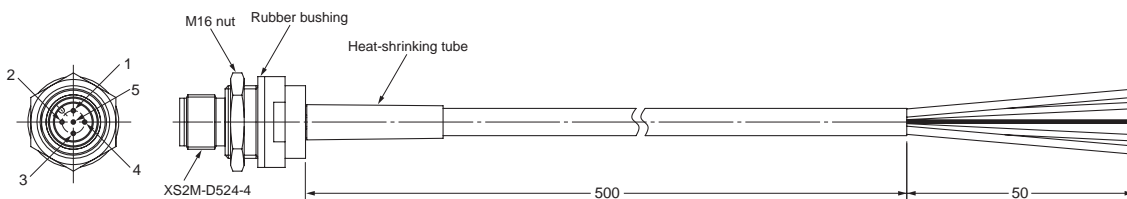

**Panel-mounting Connector (Socket), Solder-cup Terminals**  
**XS2M-D524-4**

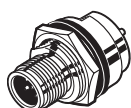

**Panel Cutout Dimensions**

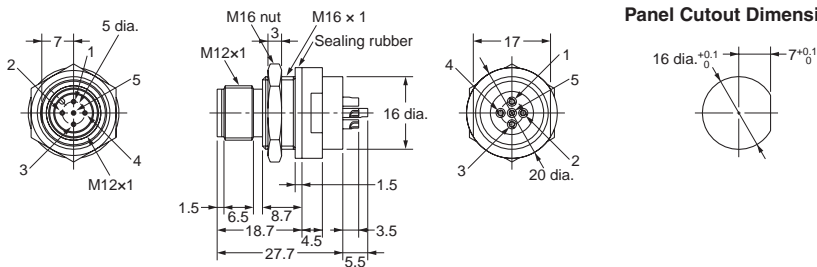



● Environment-resistive Models (for Thin Wires and M12 Micro Connectors)

Cables with Connectors on Both Ends  
DCA1-5CS□□W1

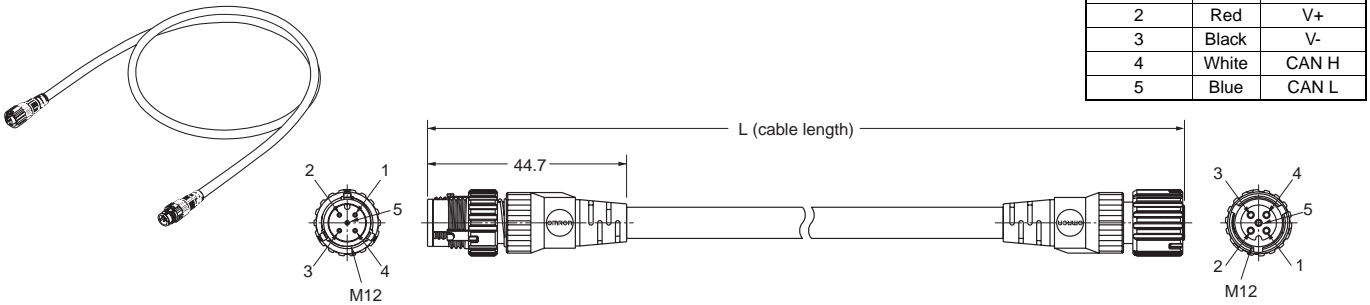

Cables with Connector on Single End (Socket)  
DCA1-5CS□□F1

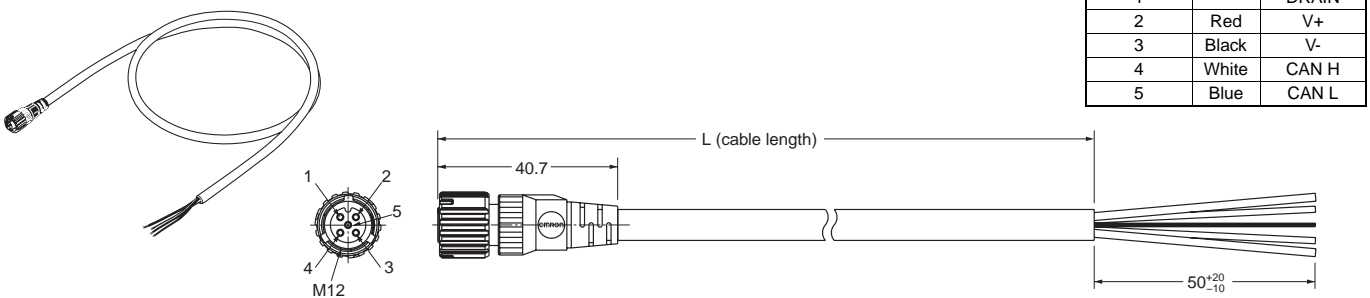

Cables with Connector on Single End (Plug)  
DCA1-5CS□□H1

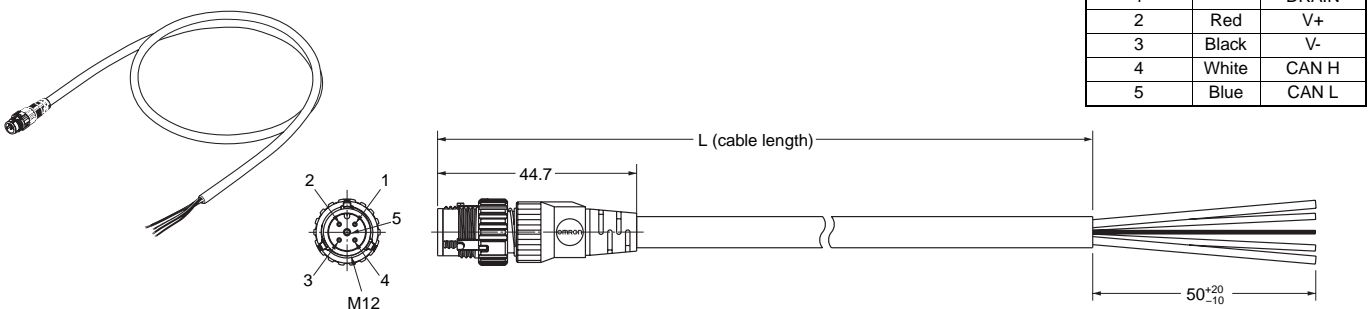

T-branch Connector  
DCN2-1S

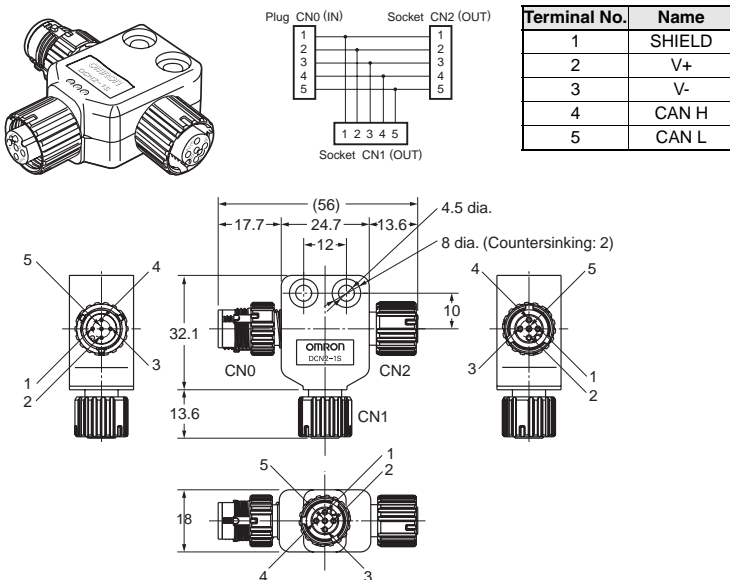

Connectors with Terminating Resistance

DRS2-1S (Plug)  
DRS2-2S (Socket)

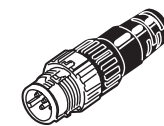

Terminal No.	Name
1	DRAIN : NC
2	V+ : NC
3	V- : NC
4	CAN H : $\sim$ 121 $\Omega$
5	CAN L : $\sim$ 121 $\Omega$

Note: Terminating resistance (121  $\Omega$ ) is connected between terminals 4 and 5.

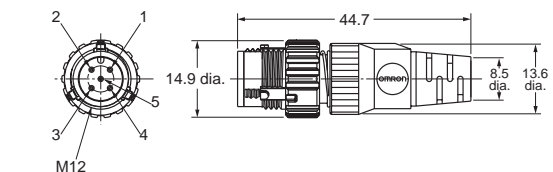

Note: The diagram shows the DRS2-1 (plug).

**Shielded Branch Relay Box with Four Ports**  
**DCN2-S4C5H1**

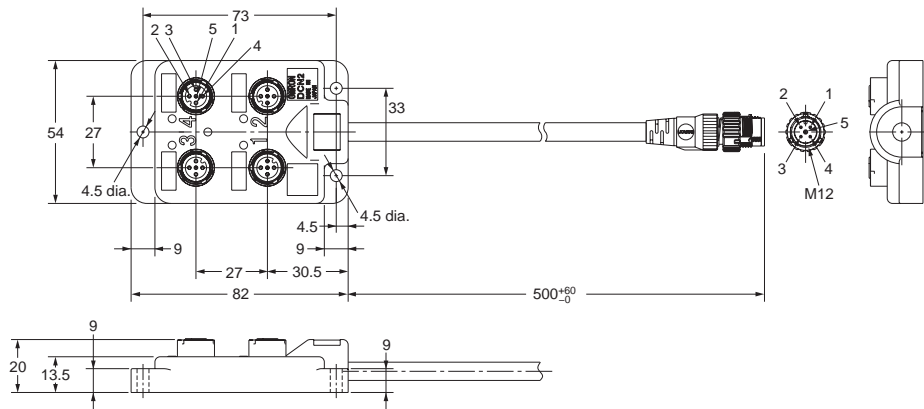
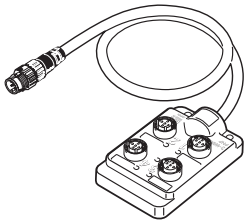

**Connections Diagram**

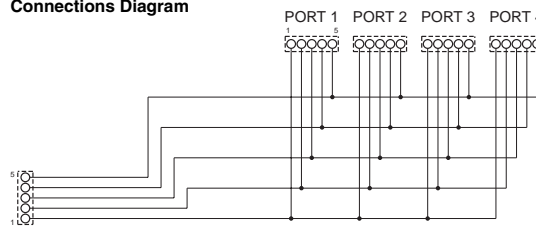

**Wiring**

Terminal No.	Color	Name
1	-	DRAIN
2	Red	V+
3	Black	V-
4	White	CAN H
5	Blue	CAN L

**Shielded Branch Relay Box with Eight Ports**  
**DCN2-S8C5H1**

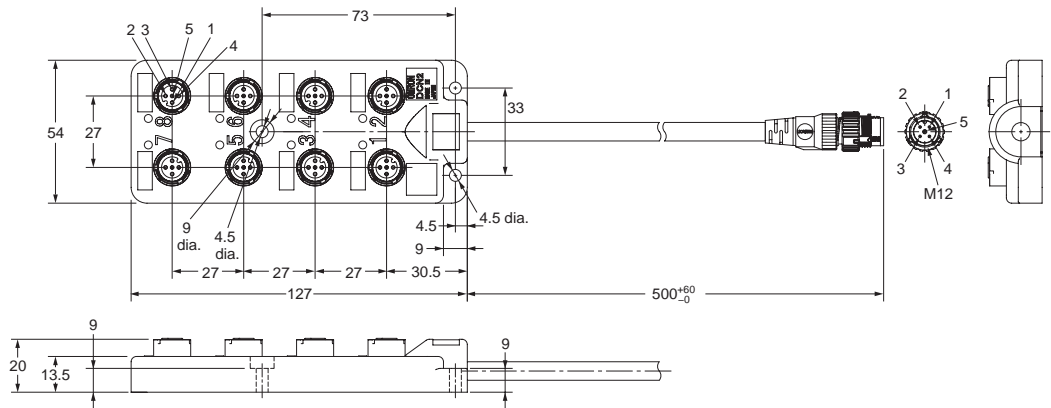
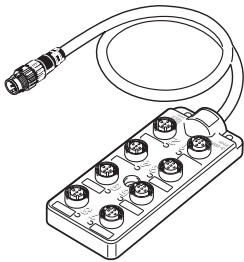

**Connections Diagram**

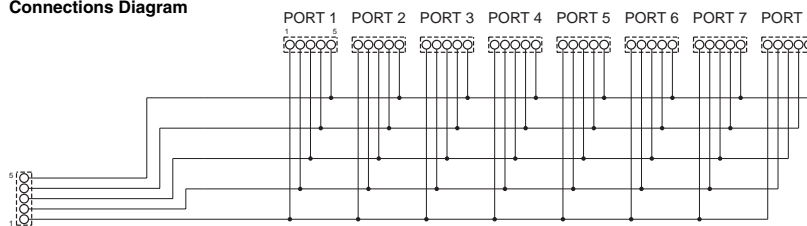

**Wiring**

Terminal No.	Color	Name
1	-	DRAIN
2	Red	V+
3	Black	V-
4	White	CAN H
5	Blue	CAN L

● Environment-resistive Models for Thick Wires with 7/8-16UN Mini Connectors

Thick Cable with Connectors on Both Ends (5 Conductors for Communications)  
DCA2-5CN□□W1

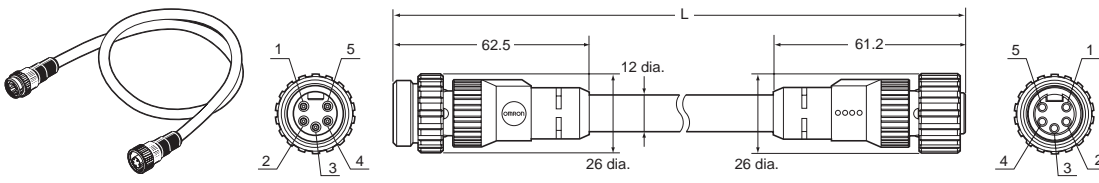

Wiring

Terminal No.	Color	Name
1	-	DRAIN
2	Red	V+
3	Black	V-
4	White	CAN H
5	Blue	CAN L

Thick Cable with Connector Socket on One End (5 Conductors for Communications)  
DCA2-5CN□□F1

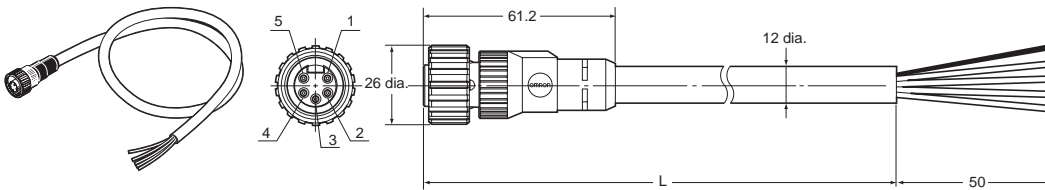

Wiring

Terminal No.	Color	Name
1	-	DRAIN
2	Red	V+
3	Black	V-
4	White	CAN H
5	Blue	CAN L

Thick Cable with Connector Plug on One End (5 Conductors for Communications)  
DCA2-5CN□□H1

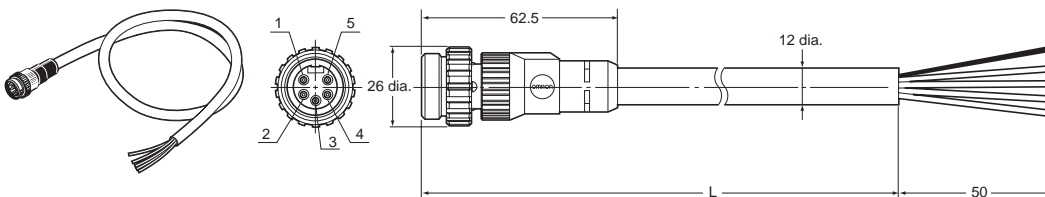

Wiring

Terminal No.	Color	Name
1	-	DRAIN
2	Red	V+
3	Black	V-
4	White	CAN H
5	Blue	CAN L

Thin Cable with Connectors on Both Ends (5 Conductors for Communications)  
DCA1-5CN□□W5

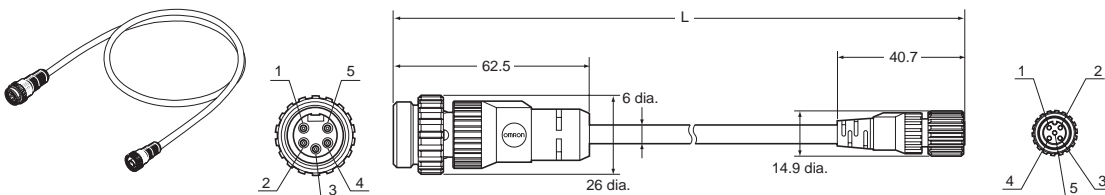

Wiring

Terminal No.	Color	Name
1	-	DRAIN
2	Red	V+
3	Black	V-
4	White	CAN H
5	Blue	CAN L

Thin Cable with Panel-mounting Connector Socket on One End (5 Conductors for Communications)  
DCA2-5CNC5P1

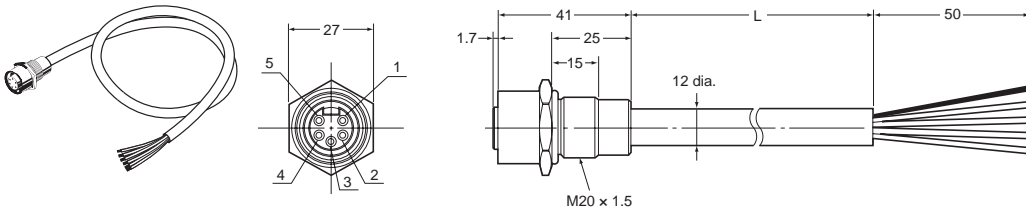

Note: A rubber seal and nut for panel mounting are included.

Panel Cutout Dimensions

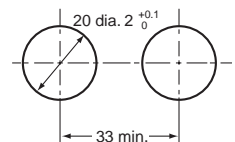

Wiring

Terminal No.	Color	Name
1	-	DRAIN
2	Red	V+
3	Black	V-
4	White	CAN H
5	Blue	CAN L

**Panel-mounting Connector (Plug) with 0.5 m Cable  
DCA2-5CNC5M1**

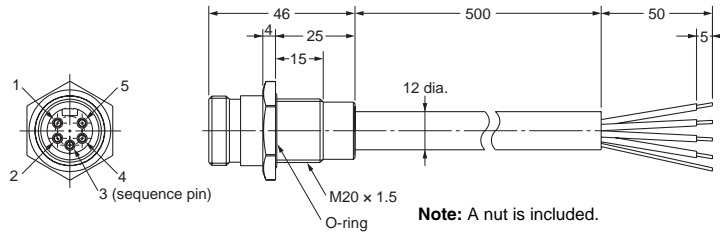
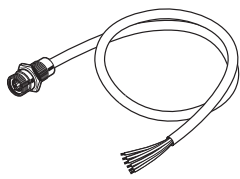

**Wiring**

Terminal No.	Color	Name
1	-	DRAIN
2	Red	V+
3	Black	V-
4	White	CAN H
5	Blue	CAN L

**T-branch Connector (5 Conductors for Communications,  
Thick Wire Branch Line)  
DCN3-11**

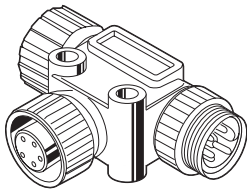

**Connections Diagram**

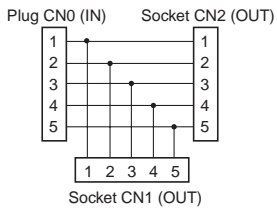

**Wiring**

Terminal No.	Name
1	DRAIN
2	V+
3	V-
4	CAN H
5	CAN L

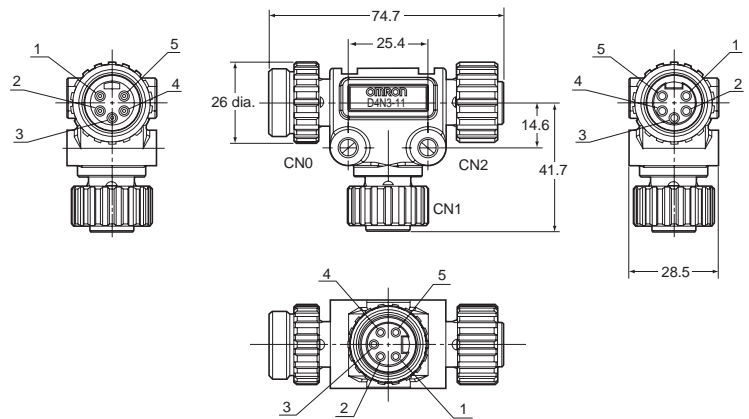

**T-branch Connector (5 Conductors for Communications,  
Thin Wire Branch Line)  
DCN3-12**

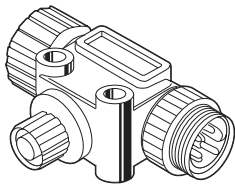

**Connections Diagram**

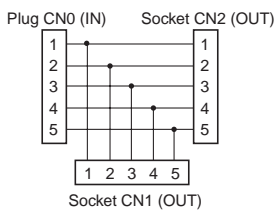

**Wiring**

Terminal No.	Name
1	DRAIN
2	V+
3	V-
4	CAN H
5	CAN L

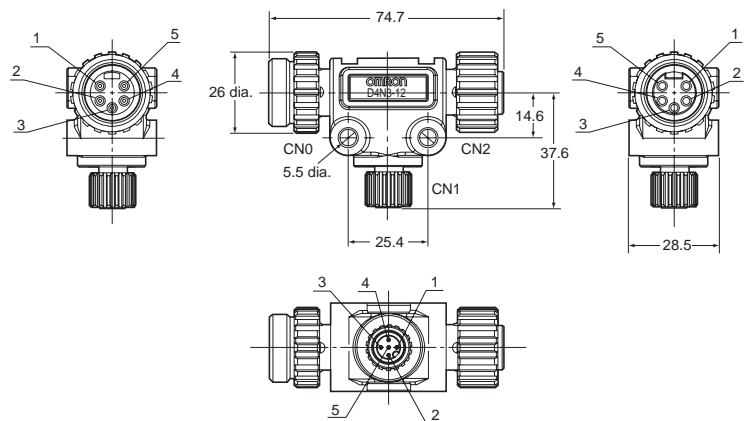

**Connector (Plug) with Terminating Resistance  
DRS3-1**

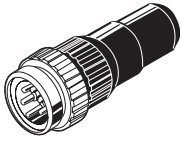

**Wiring**

Terminal No.	Name
1	DRAIN : NC
2	V+ : NC
3	V- : NC
4	CAN H :  121 Ω
5	CAN L :  121 Ω

**Note:** Terminating resistance (121 Ω) is connected between terminals 4 and 5.

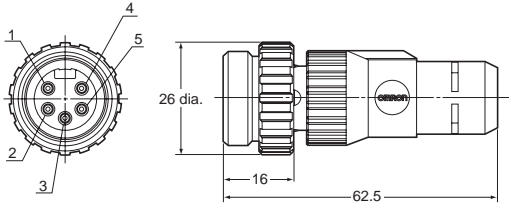

**Panel-mounting Connector (5 Pins for Communications)  
XS4M-D521-1**

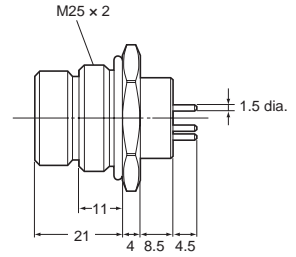
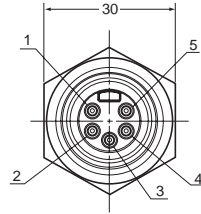

**Panel Cutout Dimensions**

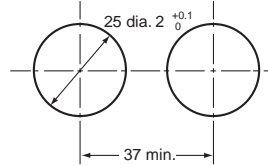

**PCB Processing Dimensions**

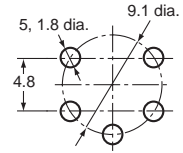

**Note:** A rubber seal and nut for panel mounting are included.

## I/O Peripheral Devices

### Applicable Connectors

● **Assembly Connector Plugs for M12 Microconnectors**

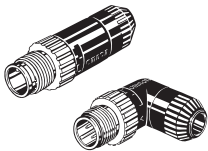
Appearance	Applicable cable diameter (mm)	Cable direction	Number of poles	Connection method		
				Crimping	Soldering	Screws
	For 6 dia. (5 to 6 dia.)	Straight	4	XS2G-D4C1	XS2G-D421	XS2G-D4S1
		L-shaped		--	XS2G-D422	XS2G-D4S2
	For 5 dia. (4 to 5 dia.)	Straight		XS2G-D4C3	XS2G-D423	XS2G-D4S3
		L-shaped		--	XS2G-D424	XS2G-D4S4
	For 3 dia. (3 to 4 dia.)	Straight		XS2G-D4C5	XS2G-D425	XS2G-D4S5
		L-shaped		--	XS2G-D426	XS2G-D4S6
	For 7 dia. (6 to 7 dia.)	Straight		--	--	XS2G-D4S9
	For 8 dia. (7 to 8 dia.)			--	--	XS2G-D4S7

### Applicable Cables with Connectors



● **Cables with Connector (Socket/Plug) on Both Ends (M12 Microconnectors for Power Supply and I/O)**

Appearance	Cable direction	Number of core wires	Cable length (m)	Standard cable	Robot (earthquake-resistant) cable
	Straight/Straight	4	1	XS2W-D421-C81-A	XS2W-D421-C81-R
			2	XS2W-D421-D81-A	XS2W-D421-D81-R
			5	XS2W-D421-G81-A	XS2W-D421-G81-R
	L-shaped/L-shaped		2	XS2W-D422-D81-A	--
			5	XS2W-D422-G81-A	
			2	XS2W-D423-D81-A	
	Straight/L-shaped		5	XS2W-D423-G81-A	
			2	XS2W-D424-D81-A	
	L-shaped/Straight		5	XS2W-D424-G81-A	

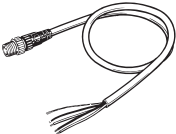
● **Cables with connector plug on One End (M12 Microconnectors for I/O)**

Appearance	Cable direction	Number of core wires	Cable length (m)	Standard cable
	Straight	3	0.3	XS2H-D421-AC0-A
		4		XS2H-D421-A80-A
		3	1	XS2H-D421-CC0-A
		4		XS2H-D421-C80-A

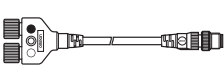
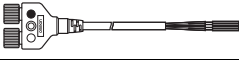
● **Plugs and Sockets on Y-shaped Joints (M12 Microconnectors for I/O)**

Appearance	Cable	Connector	DC models	
			Cable length (m)	Model
	With cable	Connectors on both ends	0.5	XS2R-D426-B11-F
			1	XS2R-D426-C11-F
			2	XS2R-D426-D11-F
			3	XS2R-D426-E11-F
		Connector on one end	2	XS2R-D426-D10-F
			5	XS2R-D426-G10-F
	Without cable	Connectors on both ends	--	XS2R-D426-1

Note: Use is supported only for Environment-resistive Terminals (DRT2-□D16C(L)(-1)).







● **Connector Cover for M12 Microconnectors**

Appearance	Product	Model	Application
	Waterproof cover (socket)	XS2Z-22	For covering unused I/O connectors

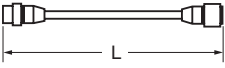
**Power Supply Peripheral Devices**

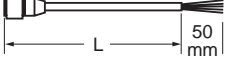
**Applicable Cables with Connectors**

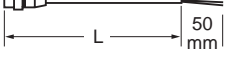
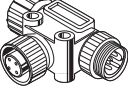
● Power Supply Connectors (7/8-16UN Miniconnectors)

Appearance	Product	Cable length L (mm)	Model
		1	XS4W-D421-101-A
		2	XS4W-D421-102-A
		5	XS4W-D421-105-A
		10	XS4W-D421-110-A
		1	XS4F-D421-101-A
		2	XS4F-D421-102-A
		5	XS4F-D421-105-A
		10	XS4F-D421-110-A
		1	XS4H-D421-101-A
		2	XS4H-D421-102-A
		5	XS4H-D421-105-A
		10	XS4H-D421-110-A
	T-branch Connector	--	XS4R-D424-5
	Panel mounting connector socket Cable: 50 cm	--	XS4P-D421-1C5-A
	Panel mounting connector plug DIP terminals	--	XS4M-D421-1
-	Waterproofing Cap for Plug	--	XS4Z-11
-	Waterproofing Cap for Socket	--	XS4Z-12

## Read and Understand This Catalog

Please read and understand this catalog before purchasing the products. Please consult your OMRON representative if you have any questions or comments.

## Warranty and Limitations of Liability

### WARRANTY

OMRON's exclusive warranty is that the products are free from defects in materials and workmanship for a period of one year (or other period if specified) from date of sale by OMRON.

OMRON MAKES NO WARRANTY OR REPRESENTATION, EXPRESS OR IMPLIED, REGARDING NON-INFRINGEMENT, MERCHANTABILITY, OR FITNESS FOR PARTICULAR PURPOSE OF THE PRODUCTS. ANY BUYER OR USER ACKNOWLEDGES THAT THE BUYER OR USER ALONE HAS DETERMINED THAT THE PRODUCTS WILL SUITABLY MEET THE REQUIREMENTS OF THEIR INTENDED USE. OMRON DISCLAIMS ALL OTHER WARRANTIES, EXPRESS OR IMPLIED.

### LIMITATIONS OF LIABILITY

OMRON SHALL NOT BE RESPONSIBLE FOR SPECIAL, INDIRECT, OR CONSEQUENTIAL DAMAGES, LOSS OF PROFITS OR COMMERCIAL LOSS IN ANY WAY CONNECTED WITH THE PRODUCTS, WHETHER SUCH CLAIM IS BASED ON CONTRACT, WARRANTY, NEGLIGENCE, OR STRICT LIABILITY.

In no event shall the responsibility of OMRON for any act exceed the individual price of the product on which liability is asserted.

IN NO EVENT SHALL OMRON BE RESPONSIBLE FOR WARRANTY, REPAIR, OR OTHER CLAIMS REGARDING THE PRODUCTS UNLESS OMRON'S ANALYSIS CONFIRMS THAT THE PRODUCTS WERE PROPERLY HANDLED, STORED, INSTALLED, AND MAINTAINED AND NOT SUBJECT TO CONTAMINATION, ABUSE, MISUSE, OR INAPPROPRIATE MODIFICATION OR REPAIR.

## Application Considerations

### SUITABILITY FOR USE

OMRON shall not be responsible for conformity with any standards, codes, or regulations that apply to the combination of products in the customer's application or use of the products.

At the customer's request, OMRON will provide applicable third party certification documents identifying ratings and limitations of use that apply to the products. This information by itself is not sufficient for a complete determination of the suitability of the products in combination with the end product, machine, system, or other application or use.

The following are some examples of applications for which particular attention must be given. This is not intended to be an exhaustive list of all possible uses of the products, nor is it intended to imply that the uses listed may be suitable for the products:

- Outdoor use, uses involving potential chemical contamination or electrical interference, or conditions or uses not described in this catalog.
- Nuclear energy control systems, combustion systems, railroad systems, aviation systems, medical equipment, amusement machines, vehicles, safety equipment, and installations subject to separate industry or government regulations.
- Systems, machines, and equipment that could present a risk to life or property.

Please know and observe all prohibitions of use applicable to the products.

NEVER USE THE PRODUCTS FOR AN APPLICATION INVOLVING SERIOUS RISK TO LIFE OR PROPERTY WITHOUT ENSURING THAT THE SYSTEM AS A WHOLE HAS BEEN DESIGNED TO ADDRESS THE RISKS, AND THAT THE OMRON PRODUCTS ARE PROPERLY RATED AND INSTALLED FOR THE INTENDED USE WITHIN THE OVERALL EQUIPMENT OR SYSTEM.

### PROGRAMMABLE PRODUCTS

OMRON shall not be responsible for the user's programming of a programmable product, or any consequence thereof.

## Disclaimers

### CHANGE IN SPECIFICATIONS

Product specifications and accessories may be changed at any time based on improvements and other reasons.

It is our practice to change model numbers when published ratings or features are changed, or when significant construction changes are made. However, some specifications of the products may be changed without any notice. When in doubt, special model numbers may be assigned to fix or establish key specifications for your application on your request. Please consult with your OMRON representative at any time to confirm actual specifications of purchased products.

### DIMENSIONS AND WEIGHTS

Dimensions and weights are nominal and are not to be used for manufacturing purposes, even when tolerances are shown.

### PERFORMANCE DATA

Performance data given in this catalog is provided as a guide for the user in determining suitability and does not constitute a warranty. It may represent the result of OMRON's test conditions, and the users must correlate it to actual application requirements. Actual performance is subject to the OMRON Warranty and Limitations of Liability.

### ERRORS AND OMISSIONS

The information in this document has been carefully checked and is believed to be accurate; however, no responsibility is assumed for clerical, typographical, or proofreading errors, or omissions.

2011.8

In the interest of product improvement, specifications are subject to change without notice.

**OMRON Corporation**  
Industrial Automation Company

<http://www.ia.omron.com/>

(c)Copyright OMRON Corporation 2011 All Right Reserved.



# Mouser Electronics

Authorized Distributor

Click to View Pricing, Inventory, Delivery & Lifecycle Information:

[Omron:](#)

[XS4F-D421-105-A](#) [XS4F-D421-102-A](#) [XS4H-D421-102-A](#) [XS4F-D421-110-A](#) [XS4F-D421-101-A](#) [XS4H-D421-101-A](#)  
[XS4H-D421-105-A](#) [XS4H-D421-110-A](#) [XS4P-D421-1C5-A](#)