

PN Series Alternate & Momentary Action Pushbutton Switches



Features/Benefits

- Momentary or locking action
- Different actuation forces for customized feel
- Low cost, reliable contact design
- Single and double pole options
- RoHS compliant

Typical Applications

- Computers and peripherals
- Instrumentation and measurement equipment
- Non-power, on-off switch applications

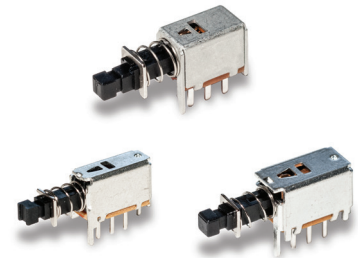

Specifications

CONTACT RATING: 0.2 AMP @ 30 V DC max.
 ELECTRICAL LIFE: 10,000 make-and-break cycles at full load.
 MECHANICAL LIFE: 10,000 on/off cycles.
 CONTACT RESISTANCE: 30 mΩ max. initial
 INSULATION RESISTANCE: 100 MΩ min.
 DIELECTRIC STRENGTH: 500 V AC min.
 OPERATING/STORAGE TEMPERATURES: -10°C to 60°C.
 PACKAGING: Switches are supplied in anti-static trays.

Materials

FRAME: Tin plated steel.
 ACTUATOR: PA 66 black.
 BASE: Phenolic resin.
 TERMINALS: Silver plated brass.
 MOVABLE CONTACTS: Silver plated phosphor bronze.
 RETURN SPRING: SWC
 DETENT SPRING: Phosphor bronze.
 DETENT SPRING PLATE: Phosphor bronze.
 RETURN SPRING RETAINER RING: Nickel plated steel.
 TERMINAL SEAL: Epoxy.

Build-A-Switch

To order, simply select desired option from each category and place in the appropriate box. For additional options not shown in catalog, consult Customer Service Center.

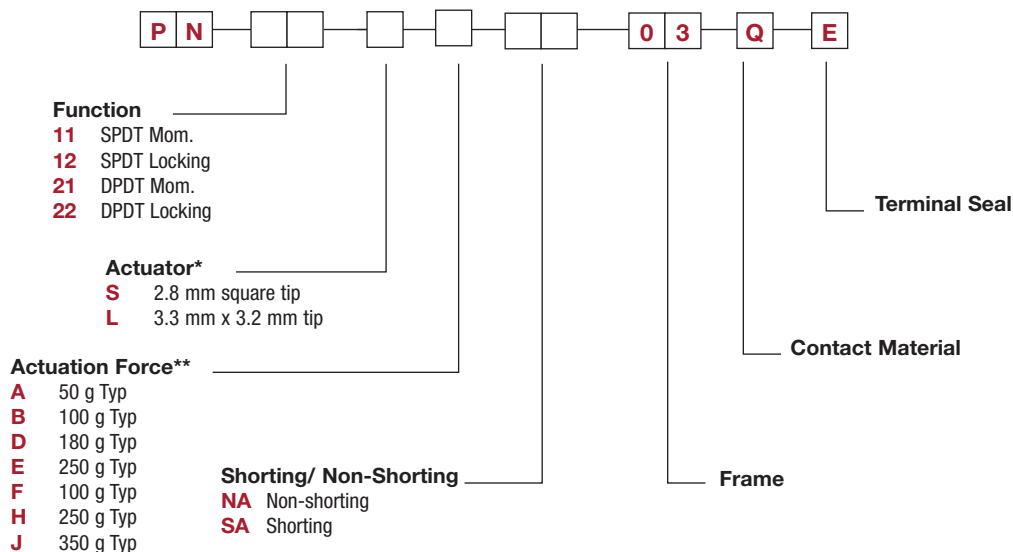

* Note - The switch body style dimensions differ for each of these 3 groupings

“S” actuator available for PN 11 & PN 12 options

“S” actuator available for PN 21 & PN 22 options

“L” actuator available for PN 21 & PN 22 options

** Actuation Force “A” only available with PN11 with “S” actuator

PN 11 & PN 21 available with Actuation Force “B”, “D”, “E”, “F”, “H”, “J”

PN 12 & PN 22 available with Actuation Force “D”, “E”, “H”, “J”

Full travel



PN Series Alternate & Momentary Action Pushbutton Switches

Pushbutton

PN 11 SPDT Mom.
PN 12 SPDT Locking

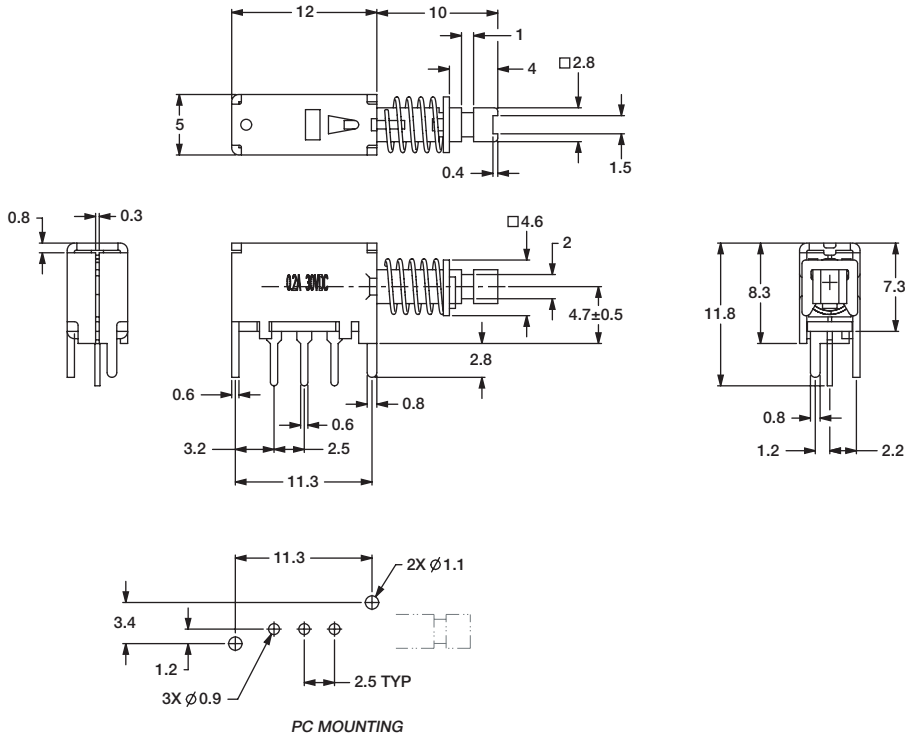

PN 21 DPDT Mom. with "S" Actuator
PN 22 DPDT Locking with "S" Actuator

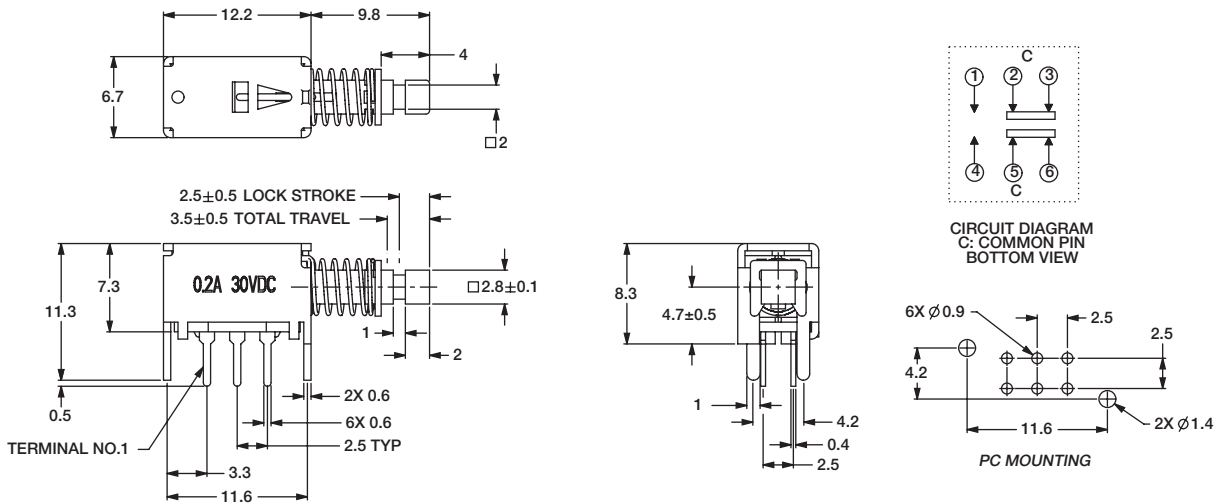

Third Angle
Projection

Dimensions are shown: mm
Specifications and dimensions subject to change



PN Series Alternate & Momentary Action Pushbutton Switches



A
Pushbutton

PN 21 DPDT Mom. with "L" Actuator
PN 22 DPDT Locking with "L" Actuator

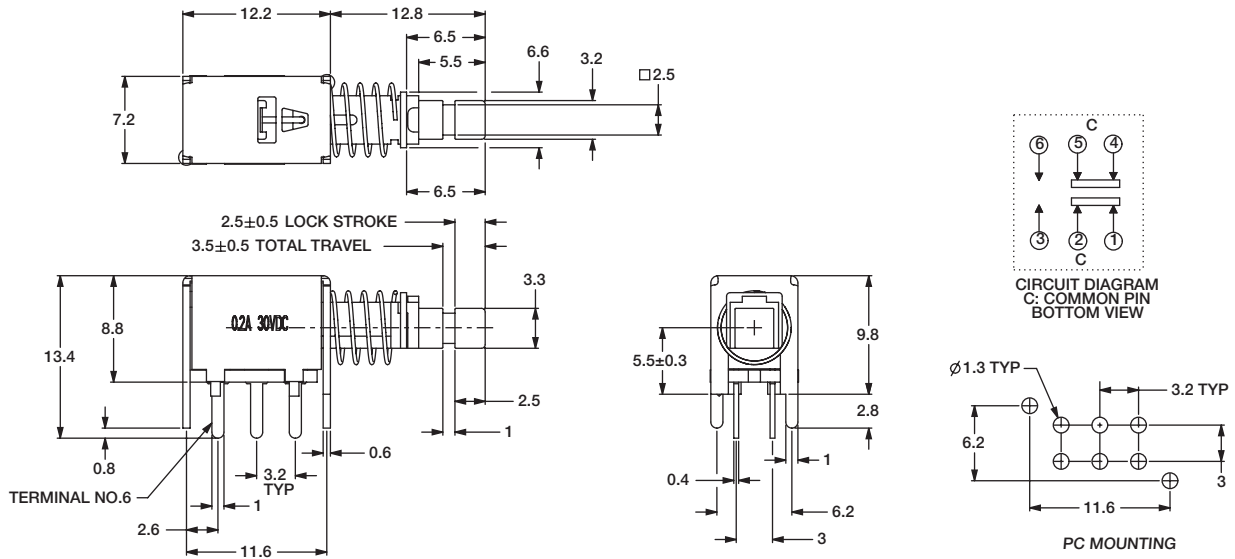

BUTTONS MUST BE ORDERED SEPARATELY. SHIPPED IN BULK.

PE

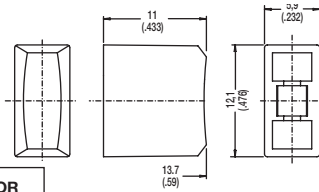
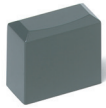

PV

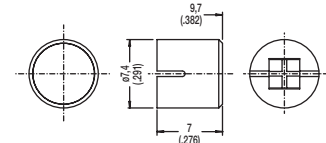

OPTION CODE	COLOR
RD	Red
GY	Gray
BK	Black
WH	White

PE and PV buttons fit "L" actuators

Indexed

- G001A** Black
- G001G** Gray
- G001I** Ivory
- G001R** Red

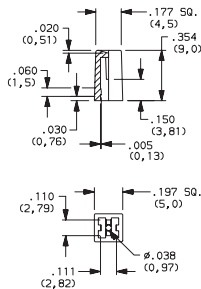
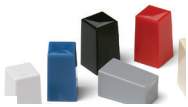

Rectangular

- G002A** Black
- G002G** Gray
- G002I** Ivory
- G002R** Red

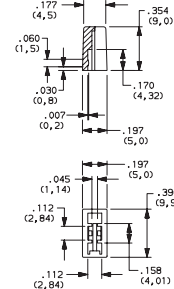

Round

- G003A** Black
- G003G** Gray
- G003I** Ivory
- G003R** Red

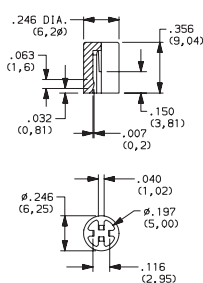

Square

- G004A** Black
- G004G** Gray
- G004I** Ivory
- G004R** Red

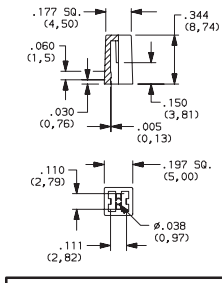
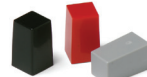

G001, G002, G003 and G004 buttons fit "S" actuators

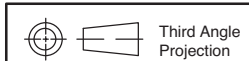

Dimensions are shown: Inches (mm)
 Specifications and dimensions subject to change

Mouser Electronics

Authorized Distributor

Click to View Pricing, Inventory, Delivery & Lifecycle Information:

C&K Switches:

[PN21SJNA03QE](#) [PN42LENA02QE](#) [PN42LESA02QE](#) [PN12SHSA03QE](#) [PN11SHNA03QE](#) [PN12SHNA03QE](#)
[PN22SJNA03QE](#) [PN11SBNA03QE](#) [PN11SBSA03QE](#) [PN11SCNA03QE](#) [PN11SCSA03QE](#) [PN11SHSA03QE](#)
[PN21LANA03QE](#) [PN21LENA03QE](#) [PN21SBNA03QE](#) [PN21SDSA03QE](#) [PN22LENA03QE](#) [PN22LESA03QE](#)
[PN22SJSA03QE](#) [PN41LENA02QE](#) [PN21SDNA03QE](#) [PN12SJNA03QE](#)