

## LXP-RS

~9.6° spot beam optimized for CREE XP-E. 14.7 mm high assembly with installation tape.

### TECHNICAL SPECIFICATIONS:

Dimensions	Ø 21.6 mm
Height	14.7 mm
Fastening	tape
Colour	black
Box size	470 x 235 x 270 mm
Box weight	11.8 kg
Quantity in Box	2304 pcs
ROHS compliant	yes ⓘ



### MATERIAL SPECIFICATIONS:

Component	Type	Material	Colour
LR1-RS	Single lens	PMMA	clear
LXP-LH1-TAPE-BLK	Holder	PC	black
LEILA-TAPE	Tape	PU tape	

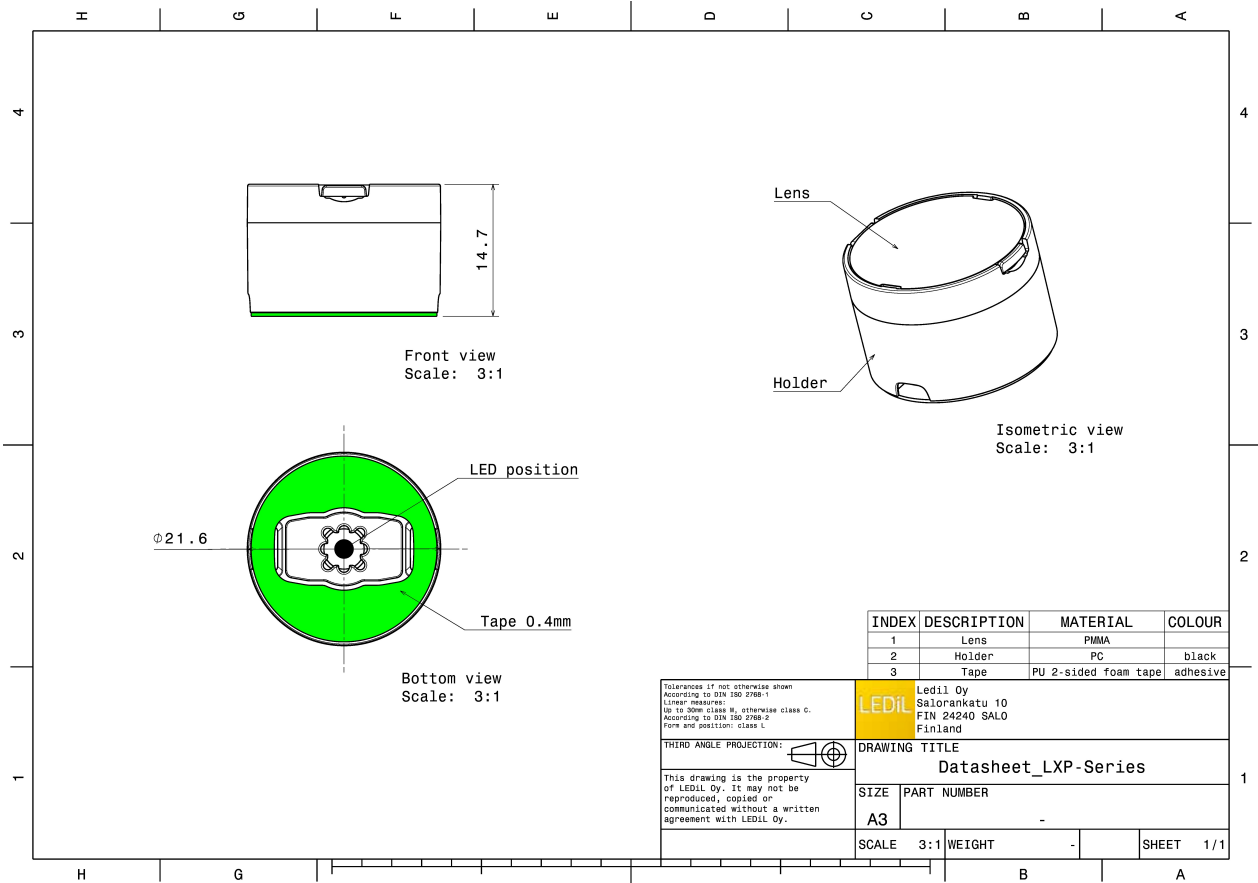

#### PHOTOMETRIC DATA (MEASURED):

#### CREE

LED XP-E  
 FWHM 7.5°  
 Efficiency 92 %  
 Peak intensity 39.700 cd/lm  
 LEDs/each optic 1  
 Light colour White  
 Required components:

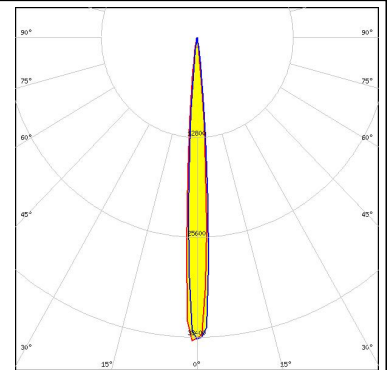

#### CREE

LED XP-E-HEW  
 FWHM 10.0°  
 Efficiency 92 %  
 Peak intensity cd/lm  
 LEDs/each optic 1  
 Light colour White  
 Required components:

#### CREE

LED XP-G  
 FWHM 11.0°  
 Efficiency 94 %  
 Peak intensity 20.800 cd/lm  
 LEDs/each optic 1  
 Light colour White  
 Required components:

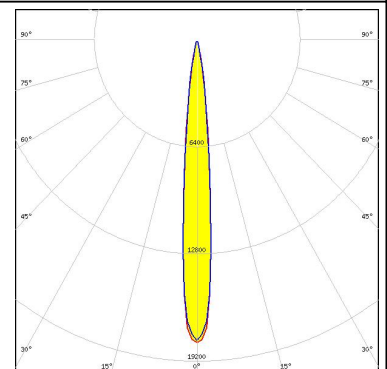

#### CREE

LED XP-L HD  
 FWHM 16.0°  
 Efficiency 91 %  
 Peak intensity 10.008 cd/lm  
 LEDs/each optic 1  
 Light colour White  
 Required components:

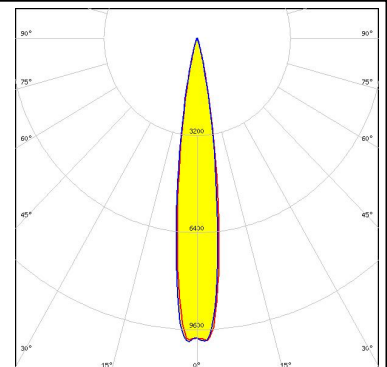
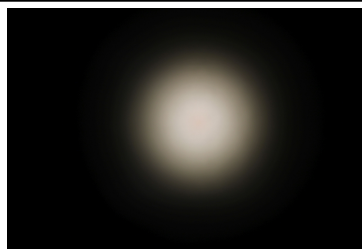

**PHOTOMETRIC DATA (MEASURED):**



LED XP-L HI  
 FWHM 10.0°  
 Efficiency 90 %  
 Peak intensity 22.000 cd/lm  
 LEDs/each optic 1  
 Light colour White  
 Required components:

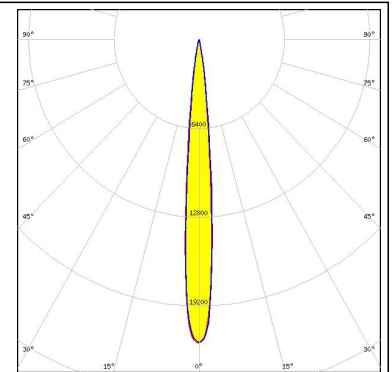
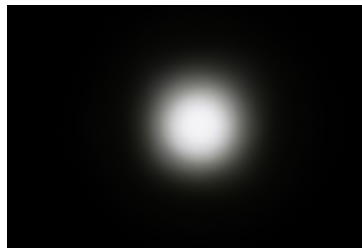

LED OSOLON Square CSSRM2/CSSRM3  
 FWHM 10.0°  
 Efficiency 93 %  
 Peak intensity 21.000 cd/lm  
 LEDs/each optic 1  
 Light colour White  
 Required components:

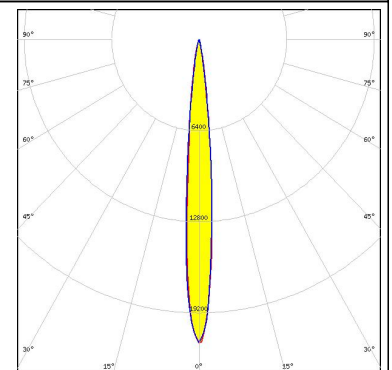

LED Z5  
 FWHM 10.0°  
 Efficiency %  
 Peak intensity cd/lm  
 LEDs/each optic 1  
 Light colour White  
 Required components:

#### PHOTOMETRIC DATA (SIMULATED):



LED XP-G3  
 FWHM 12.0°  
 Efficiency 86 %  
 Peak intensity 14.000 cd/lm  
 LEDs/each optic 1  
 Light colour White  
 Required components:

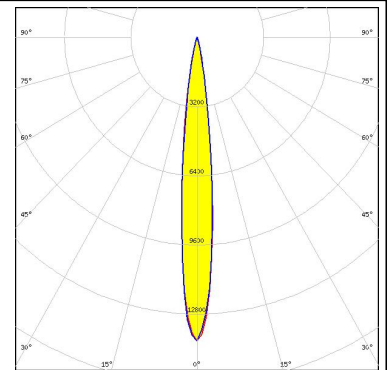

LED XT-E  
 FWHM 9.0°  
 Efficiency 88 %  
 Peak intensity 20.680 cd/lm  
 LEDs/each optic 1  
 Light colour White  
 Required components:

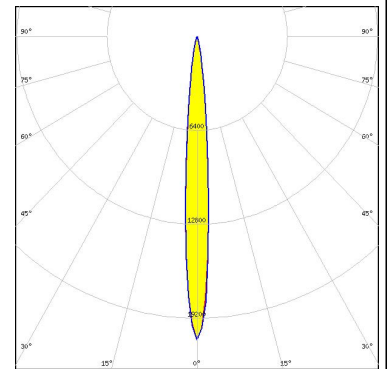

LED LUXEON V2  
 FWHM 11.0°  
 Efficiency 93 %  
 Peak intensity 16.000 cd/lm  
 LEDs/each optic 1  
 Light colour White  
 Required components:

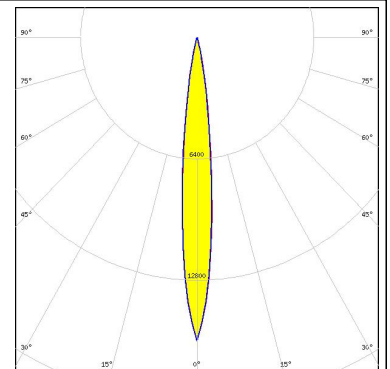

### GENERAL INFORMATION:

NOTE: The typical beam angle will be changed by different color, chip size and chip position tolerance. The typical total beam angle is the full angle measured where the luminous intensity is half of the peak value.

### MATERIALS:

As part of our continuous research and improvement processes, and to ensure the best possible quality and availability of our products, LEDiL reserves the right to change material grades without notice.

### PRODUCT DATA USER AGREEMENT AND DISCLAIMER:

The measured data in the provided downloadable LEDiL Product Datasheets and Mechanical 2D-Drawings is rounded and provided as reference for planning. LEDiL Oy's optical specifications have been verified by conducting performance testing of the products in accordance with the company's quality system. The reported data are averaged results of multiple measurements with typical variation. LEDiL Oy reserves the right to without prior notification make changes and improvements to its products.

LEDiL Oy assumes neither warranty, nor guarantee nor any other liability of any kind for the contents and correctness of the provided data. The provided data has been generated with highest diligence but the provided data may in reality not represent the complete possible variation range of all intrinsic parameters. Therefore, in certain cases a deviation from the provided data could occur.

LEDiL Oy reserves the right to undertake technical changes of its products without further notification which could lead to changes in the provided data. LEDiL Oy assumes no liability of any kind for the possible deviation from any provided data or any other damage resulting from the usage of the provided data.

The user agrees to this disclaimer and user agreement with the download or usage of the provided files.

#### LEDiL Oy

Joensuunkatu 13  
FI-24240 SALO  
Finland

#### LEDiL Inc.

228 West Page Street  
Suite D  
Sycamore IL 60178  
USA

#### Local sales and technical support

[www.ledil.com/  
where\\_to\\_buy](http://www.ledil.com/where_to_buy)

#### Shipping locations

Salo, Finland  
Hong Kong, China

#### Distribution Partners

[www.ledil.com/  
where\\_to\\_buy](http://www.ledil.com/where_to_buy)

# Mouser Electronics

Authorized Distributor

Click to View Pricing, Inventory, Delivery & Lifecycle Information:

[Ledi:](#)

[FA10661\\_LXP-RS](#)