

12-/14-Bit, 160/250MSPS, Ultralow-Power ADC

 Check for Samples: [ADS4126](#), [ADS4129](#), [ADS4146](#), [ADS4149](#)

FEATURES

- **Maximum Sample Rate: 250MSPS**
- **Ultralow Power with 1.8V Single Supply:**
 - **201mW Total Power at 160MSPS**
 - **265mW Total Power at 250MSPS**
- **High Dynamic Performance:**
 - **SNR: 70.6dBFS at 170MHz**
 - **SFDR: 84dBc at 170MHz**
- **Dynamic Power Scaling with Sample Rate**
- **Output Interface:**
 - **Double Data Rate (DDR) LVDS with Programmable Swing and Strength**
 - **Standard Swing: 350mV**
 - **Low Swing: 200mV**
 - **Default Strength: 100Ω Termination**
 - **2x Strength: 50Ω Termination**
 - **1.8V Parallel CMOS Interface Also Supported**
- **Programmable Gain up to 6dB for SNR/SFDR Trade-Off**
- **DC Offset Correction**
- **Supports Low Input Clock Amplitude Down To 200mV_{PP}**
- **Package: QFN-48 (7mm × 7mm)**

DESCRIPTION

The ADS412x/4x are a family of 12-bit/14-bit analog-to-digital converters (ADCs) with sampling rates up to 250MSPS. These devices use innovative design techniques to achieve high dynamic performance, while consuming extremely low power at 1.8V supply. The devices are well-suited for multi-carrier, wide bandwidth communications applications.

The ADS412x/4x have fine gain options that can be used to improve SFDR performance at lower full-scale input ranges, especially at high input frequencies. They include a dc offset correction loop that can be used to cancel the ADC offset. At lower sampling rates, the ADC automatically operates at scaled down power with no loss in performance.

The ADS412x/4x are available in a compact QFN-48 package and are specified over the industrial temperature range (–40°C to +85°C)

ADS412x/ADS414x Family Comparison

FAMILY	SAMPLING RATE				WITH ANALOG INPUT BUFFERS	
	65MSPS	125MSPS	160MSPS	250MSPS	200MSPS	250MSPS
ADS412x 12-bit family	ADS4122	ADS4125	ADS4126	ADS4129	—	ADS41B29
ADS414x 14-bit family	ADS4142	ADS4145	ADS4146	ADS4149	—	ADS41B49
9-bit	—	—	—	—	—	ADS58B19
11-bit	—	—	—	—	ADS58B18	—



Please be aware that an important notice concerning availability, standard warranty, and use in critical applications of Texas Instruments semiconductor products and disclaimers thereto appears at the end of this data sheet.

PowerPAD is a trademark of Texas Instruments Incorporated.
All other trademarks are the property of their respective owners.



This integrated circuit can be damaged by ESD. Texas Instruments recommends that all integrated circuits be handled with appropriate precautions. Failure to observe proper handling and installation procedures can cause damage.

ESD damage can range from subtle performance degradation to complete device failure. Precision integrated circuits may be more susceptible to damage because very small parametric changes could cause the device not to meet its published specifications.

ORDERING INFORMATION⁽¹⁾

PRODUCT	PACKAGE-LEAD	PACKAGE DESIGNATOR	SPECIFIED TEMPERATURE RANGE	ECO PLAN ⁽²⁾	LEAD/BALL FINISH	PACKAGE MARKING	ORDERING NUMBER	TRANSPORT MEDIA, QUANTITY
ADS4126	QFN-48	RGZ	-40°C to +85°C	GREEN (RoHS, no Sb/Br)	Cu/NiPdAu	AZ4126	ADS4126IRGZR	Tape and reel, 2500
							ADS4126IRGZT	Tape and reel, 250
ADS4129	QFN-48	RGZ	-40°C to +85°C	GREEN (RoHS, no Sb/Br)	Cu/NiPdAu	AZ4129	ADS4129IRGZR	Tape and reel, 2500
							ADS4129IRGZT	Tape and reel, 250
ADS4146	QFN-48	RGZ	-40°C to +85°C	GREEN (RoHS, no Sb/Br)	Cu/NiPdAu	AZ4146	ADS4146IRGZR	Tape and reel, 2500
							ADS4146IRGZT	Tape and reel, 250
ADS4149	QFN-48	RGZ	-40°C to +85°C	GREEN (RoHS, no Sb/Br)	Cu/NiPdAu	AZ4149	ADS4149IRGZR	Tape and reel, 2500
							ADS4149IRGZT	Tape and reel, 250

- (1) For the most current package and ordering information, see the Package Option Addendum at the end of this document, or visit the device product folder at www.ti.com.
- (2) Eco Plan is the planned eco-friendly classification. Green (RoHS, no Sb/Br): TI defines *Green* to mean Pb-Free (RoHS compatible) and free of Bromine- (Br) and Antimony- (Sb) based flame retardants. Refer to the [Quality and Lead-Free \(Pb-Free\) Data](#) web site for more information.

The ADS412x/4x family is pin-compatible with the previous generation [ADS6149](#) family; this architecture enables easy migration. However, there are some important differences between the generations, summarized in [Table 1](#).

Table 1. MIGRATING FROM THE ADS6149 FAMILY

ADS6149 FAMILY	ADS4149 FAMILY
PINS	
Pin 21 is NC (not connected)	Pin 21 is NC (not connected)
Pin 23 is MODE	Pin 23 is RESERVED in the ADS4149 family. It is reserved as a digital control pin for an (as yet) undefined function in the next-generation ADC series.
SUPPLY	
AVDD is 3.3V	AVDD is 1.8V
DRVDD is 1.8V	No change
INPUT COMMON-MODE VOLTAGE	
VCM is 1.5V	VCM is 0.95V
SERIAL INTERFACE	
Protocol: 8-bit register address and 8-bit register data	No change in protocol
	New serial register map
EXTERNAL REFERENCE MODE	
Supported	Not supported
ADS61B49 FAMILY	ADS41B29/B49/ADS58B18 FAMILY
PINS	
Pin 21 is NC (not connected)	Pin 21 is 3.3V AVDD_BUF (supply for the analog input buffers)
Pin 23 is MODE	Pin 23 is a digital control pin for the RESERVED function. Pin 23 functions as SNR Boost enable (B18 only).
SUPPLY	
AVDD is 3.3V	AVDD is 1.8V, AVDD_BUF is 3.3V
DRVDD is 1.8V	No change
INPUT COMMON-MODE VOLTAGE	
VCM is 1.5V	VCM is 1.7V
SERIAL INTERFACE	
Protocol: 8-bit register address and 8-bit register data	No change in protocol
	New serial register map
EXTERNAL REFERENCE MODE	
Supported	Not supported

ABSOLUTE MAXIMUM RATINGS⁽¹⁾

Over operating free-air temperature range, unless otherwise noted.

		VALUE	UNIT
Supply voltage range, AVDD		–0.3 to 2.1	V
Supply voltage range, DRVDD		–0.3 to 2.1	V
Voltage between AGND and DRGND		–0.3 to 0.3	V
Voltage between AVDD to DRVDD (when AVDD leads DRVDD)		0 to 2.1	V
Voltage between DRVDD to AVDD (when DRVDD leads AVDD)		0 to 2.1	V
Voltage applied to input pins	INP, INM	–0.3 to minimum (1.9, AVDD + 0.3)	V
	CLKP, CLKM ⁽²⁾ , DFS, OE	–0.3 to AVDD + 0.3	V
	RESET, SCLK, SDATA, SEN	–0.3 to 3.9	V
Operating free-air temperature range, T _A		–40 to +85	°C
Operating junction temperature range, T _J		+125	°C
Storage temperature range, T _{stg}		–65 to +150	°C
ESD, human body model (HBM)		2	kV

- (1) Stresses above these ratings may cause permanent damage. Exposure to absolute maximum conditions for extended periods may degrade device reliability. These are stress ratings only, and functional operation of the device at these or any other conditions beyond those specified is not implied.
- (2) When AVDD is turned off, it is recommended to switch off the input clock (or ensure the voltage on CLKP, CLKM is less than |0.3V|. This prevents the ESD protection diodes at the clock input pins from turning on.

THERMAL INFORMATION

THERMAL METRIC ⁽¹⁾		ADS4126, ADS4129, ADS4146, ADS4149	UNITS
		RGZ	
		48 PINS	
θ _{JA}	Junction-to-ambient thermal resistance	29	°C/W
θ _{JCtop}	Junction-to-case (top) thermal resistance		
θ _{JB}	Junction-to-board thermal resistance	10	
ψ _{JT}	Junction-to-top characterization parameter	0.3	
ψ _{JB}	Junction-to-board characterization parameter	9	
θ _{JCbot}	Junction-to-case (bottom) thermal resistance	1.13	

- (1) For more information about traditional and new thermal metrics, see the *IC Package Thermal Metrics* application report, [SPRA953](#).

RECOMMENDED OPERATING CONDITIONS

Over operating free-air temperature range, unless otherwise noted.

		ADS412x, ADS414x			UNIT
		MIN	TYP	MAX	
SUPPLIES					
AVDD	Analog supply voltage	1.7	1.8	1.9	V
DRVDD	Digital supply voltage	1.7	1.8	1.9	V
ANALOG INPUTS					
Differential input voltage range ⁽¹⁾			2		V _{PP}
Input common-mode voltage			V _{CM} ± 0.05		V
Maximum analog input frequency with 2V _{PP} input amplitude ⁽²⁾			400		MHz
Maximum analog input frequency with 1V _{PP} input amplitude ⁽²⁾			800		MHz
CLOCK INPUT					
Input clock sample rate					
ADS4129/ADS4149					
Low-speed mode enabled ⁽³⁾		20		80	MSPS
Low-speed mode disabled ⁽³⁾		> 80		250	MSPS
ADS4126/ADS4146					
Low-speed mode enabled ⁽³⁾		20		80	MSPS
Low-speed mode disabled ⁽³⁾		> 80		160	MSPS
Input clock amplitude differential (V _{CLKP} – V _{CLKM})					
Sine wave, ac-coupled		0.2	1.5		V _{PP}
LVPECL, ac-coupled			1.6		V _{PP}
LVDS, ac-coupled			0.7		V _{PP}
LVCMOS, single-ended, ac-coupled			1.8		V
Input clock duty cycle					
Low-speed mode enabled		40	50	60	%
Low-speed mode disabled		35	50	65	%
DIGITAL OUTPUTS					
C _{LOAD}	Maximum external load capacitance from each output pin to DRGND		5		pF
R _{LOAD}	Differential load resistance between the LVDS output pairs (LVDS mode)		100		Ω
T _A	Operating free-air temperature	–40		+85	°C
HIGH PERFORMANCE MODES⁽⁴⁾⁽⁵⁾⁽⁶⁾					
Mode 1	Set the MODE 1 register bits to get best performance across sample clock and input signal frequencies. Register address = 03h, register data = 03h				
Mode 2	Set the MODE 2 register bit to get best performance at high input signal frequencies. Register address = 4Ah, register data = 01h				

(1) With 0dB gain. See the [Fine Gain](#) section in the [Application Information](#) for relation between input voltage range and gain.

(2) See the [Theory of Operation](#) section in the [Application Information](#).

(3) See the [Serial Interface](#) section for details on low-speed mode.

(4) It is recommended to use these modes to get best performance. These modes can be set using the serial interface only.

(5) See the [Serial Interface](#) section for details on register programming.

(6) Note that these modes cannot be set when the serial interface is not used (when the RESET pin is tied high); see the [Device Configuration](#) section.

ELECTRICAL CHARACTERISTICS: ADS4126/ADS4129

Typical values are at +25°C, AVDD = 1.8V, DRVDD = 1.8V, 50% clock duty cycle, –1dBFS differential analog input, 1dB gain, and DDR LVDS interface, unless otherwise noted. Minimum and maximum values are across the full temperature range:

T_{MIN} = –40°C to T_{MAX} = +85°C, AVDD = 1.8V, and DRVDD = 1.8V. Note that after reset, the device is in 0dB gain mode.

PARAMETER	TEST CONDITIONS	ADS4126 (160MSPS)			ADS4129 (250MSPS)			UNIT	
		MIN	TYP	MAX	MIN	TYP	MAX		
Resolution				12			12	Bits	
SNR (signal-to-noise ratio), LVDS	f _{IN} = 10MHz		70.2			69.8		dBFS	
	f _{IN} = 70MHz		70			69.7		dBFS	
	f _{IN} = 100MHz		69.7			69.6		dBFS	
	f _{IN} = 170MHz	66.5	69		65.8	69		dBFS	
	f _{IN} = 300MHz		68			68		dBFS	
SINAD (signal-to-noise and distortion ratio), LVDS	f _{IN} = 10MHz		70.1			69.7		dBFS	
	f _{IN} = 70MHz		70			69.4		dBFS	
	f _{IN} = 100MHz		69.5			69.3		dBFS	
	f _{IN} = 170MHz	65.5	68.7		65.5	68.7		dBFS	
	f _{IN} = 300MHz		67.3			66.8		dBFS	
Spurious-free dynamic range	SFDR	f _{IN} = 10MHz		88		87		dBc	
		f _{IN} = 70MHz		87		82		dBc	
		f _{IN} = 100MHz		86.3		81		dBc	
		f _{IN} = 170MHz	72.5	82		70	80		dBc
		f _{IN} = 300MHz		77.5			75		dBc
Total harmonic distortion	THD	f _{IN} = 10MHz		87		85		dBc	
		f _{IN} = 70MHz		85		80		dBc	
		f _{IN} = 100MHz		84		79		dBc	
		f _{IN} = 170MHz	70	81		69	79		dBc
		f _{IN} = 300MHz		74.5			71.5		dBc
Second-harmonic distortion	HD2	f _{IN} = 10MHz		92		90		dBc	
		f _{IN} = 70MHz		90		85		dBc	
		f _{IN} = 100MHz		88		84		dBc	
		f _{IN} = 170MHz	72.5	88		70	84		dBc
		f _{IN} = 300MHz		78			74		dBc
Third-harmonic distortion	HD3	f _{IN} = 10MHz		88		87		dBc	
		f _{IN} = 70MHz		87		82		dBc	
		f _{IN} = 100MHz		86		81		dBc	
		f _{IN} = 170MHz	72.5	82		70	80		dBc
		f _{IN} = 300MHz		77			75		dBc
Worst spur (other than second and third harmonics)		f _{IN} = 10MHz		92		90		dBc	
		f _{IN} = 70MHz		91		88		dBc	
		f _{IN} = 100MHz		90		90		dBc	
		f _{IN} = 170MHz	76	90		75	88		dBc
		f _{IN} = 300MHz		88			88		dBc
Two-tone intermodulation distortion	IMD	f ₁ = 46MHz, f ₂ = 50MHz, each tone at –7dBFS		–88		–88		dBFS	
		f ₁ = 185MHz, f ₂ = 190MHz, each tone at –7dBFS		–86		–86		dBFS	
Input overload recovery		Recovery to within 1% (of final value) for 6dB overload with sine-wave input		1		1		Clock cycles	
AC power-supply rejection ratio	PSRR	For 100mV _{PP} signal on AVDD supply, up to 10MHz		> 30		> 30		dB	
Effective number of bits	ENOB	f _{IN} = 170MHz		11.2		11.2		LSBs	
Differential nonlinearity	DNL	f _{IN} = 170MHz	–0.85	±0.2	2.5	–0.95	±0.2	2.5	LSBs
Integrated nonlinearity	INL	f _{IN} = 170MHz		±0.25	3.5		±0.5	5	LSBs

ELECTRICAL CHARACTERISTICS: ADS4146/ADS4149

Typical values are at +25°C, AVDD = 1.8V, DRVDD = 1.8V, 50% clock duty cycle, –1dBFS differential analog input, 1dB gain, and DDR LVDS interface, unless otherwise noted. Minimum and maximum values are across the full temperature range: T_{MIN} = –40°C to T_{MAX} = +85°C, AVDD = 1.8V, and DRVDD = 1.8V. Note that after reset, the device is in 0dB gain mode.

PARAMETER	TEST CONDITIONS	ADS4146 (160MSPS)			ADS4149 (250MSPS)			UNIT	
		MIN	TYP	MAX	MIN	TYP	MAX		
Resolution				14			14	Bits	
SNR (signal-to-noise ratio), LVDS	f _{IN} = 10MHz		72.2			71.9		dBFS	
	f _{IN} = 70MHz		72			71.4		dBFS	
	f _{IN} = 100MHz		71.5			71.4		dBFS	
	f _{IN} = 170MHz	68.5	70.8		67.5	70.6		dBFS	
	f _{IN} = 300MHz		69			69		dBFS	
SINAD (signal-to-noise and distortion ratio), LVDS	f _{IN} = 10MHz		72			71.6		dBFS	
	f _{IN} = 70MHz		71.8			71		dBFS	
	f _{IN} = 100MHz		71.4			70.9		dBFS	
	f _{IN} = 170MHz	67.5	70.4		66	69.4		dBFS	
	f _{IN} = 300MHz		68.2			67.4		dBFS	
Spurious-free dynamic range	SFDR	f _{IN} = 10MHz		88		87		dBc	
		f _{IN} = 70MHz		87		82		dBc	
		f _{IN} = 100MHz		86		81		dBc	
		f _{IN} = 170MHz	74.5	82		72	84		dBc
		f _{IN} = 300MHz		77			75		dBc
Total harmonic distortion	THD	f _{IN} = 10MHz		86.5		85		dBc	
		f _{IN} = 70MHz		85		80		dBc	
		f _{IN} = 100MHz		84		79		dBc	
		f _{IN} = 170MHz	72	81		71	80.5		dBc
		f _{IN} = 300MHz		74.5			71.5		dBc
Second-harmonic distortion	HD2	f _{IN} = 10MHz		91		89		dBc	
		f _{IN} = 70MHz		90		85		dBc	
		f _{IN} = 100MHz		88		84		dBc	
		f _{IN} = 170MHz	74.5	88		72	84		dBc
		f _{IN} = 300MHz		79			75		dBc
Third-harmonic distortion	HD3	f _{IN} = 10MHz		88		87		dBc	
		f _{IN} = 70MHz		87		82		dBc	
		f _{IN} = 100MHz		86		81		dBc	
		f _{IN} = 170MHz	74.5	82		72	82		dBc
		f _{IN} = 300MHz		77			75		dBc
Worst spur (other than second and third harmonics)		f _{IN} = 10MHz		91		90		dBc	
		f _{IN} = 70MHz		90		88		dBc	
		f _{IN} = 100MHz		90		90		dBc	
		f _{IN} = 170MHz	78	90		77	88		dBc
		f _{IN} = 300MHz		88			88		dBc
Two-tone intermodulation distortion	IMD	f ₁ = 46MHz, f ₂ = 50MHz, each tone at –7dBFS		–88		–88		dBFS	
		f ₁ = 185MHz, f ₂ = 190MHz, each tone at –7dBFS		–86		–86		dBFS	
Input overload recovery		Recovery to within 1% (of final value) for 6dB overload with sine-wave input		1		1		Clock cycles	
AC power-supply rejection ratio	PSRR	For 100mV _{PP} signal on AVDD supply, up to 10MHz		> 30		> 30		dB	
Effective number of bits	ENOB	f _{IN} = 170MHz		11.5		11.3		LSBs	
Differential nonlinearity	DNL	f _{IN} = 170MHz	–0.95	±0.5		–0.95	±0.5	LSBs	
Integrated nonlinearity	INL	f _{IN} = 170MHz		±2	±4.5		±2	±5	LSBs

ELECTRICAL CHARACTERISTICS: GENERAL

Typical values are at +25°C, AVDD = 1.8V, DRVDD = 1.8V, 50% clock duty cycle, and 0dB gain, unless otherwise noted. Minimum and maximum values are across the full temperature range: T_{MIN} = –40°C to T_{MAX} = +85°C, AVDD = 1.8V, and DRVDD = 1.8V.

PARAMETER	ADS4126/ADS4146 (160MSPS)			ADS4129/ADS4149 (250MSPS)			UNIT		
	MIN	TYP	MAX	MIN	TYP	MAX			
ANALOG INPUTS									
Differential input voltage range		2			2		V _{PP}		
Differential input resistance (at dc); see Figure 114		> 1			> 1		MΩ		
Differential input capacitance; see Figure 115		4			4		pF		
Analog input bandwidth		550			550		MHz		
Analog input common-mode current (per input pin)		0.6			0.6		μA/MSPS		
Common-mode output voltage	VCM	0.95			0.95		V		
VCM output current capability		4			4		mA		
DC ACCURACY									
Offset error		–15	2.5	15		–15	2.5	15	mV
Temperature coefficient of offset error			0.003			0.003			mV/°C
Gain error as a result of internal reference inaccuracy alone	E _{GREF}	–2		2		–2		2	%FS
Gain error of channel alone	E _{GCHAN}		–0.2			–0.2		–1	%FS
Temperature coefficient of E _{GCHAN}			0.001			0.001			Δ%/°C
POWER SUPPLY									
IAVDD Analog supply current			72	83			99	113	mA
IDRVDD ⁽¹⁾ Output buffer supply current LVDS interface with 100Ω external termination Low LVDS swing (200mV)			39.5	51			47		mA
IDRVDD Output buffer supply current LVDS interface with 100Ω external termination Standard LVDS swing (350mV)			51	63			59	72	mA
IDRVDD output buffer supply current ⁽¹⁾⁽²⁾ CMOS interface ⁽²⁾ 8pF external load capacitance f _{IN} = 2.5MHz			26				35		mA
Analog power			130				179		mW
LVDS interface, low LVDS swing			71.1				84.6		mW
Digital power CMOS interface ⁽²⁾ 8pF external load capacitance f _{IN} = 2.5MHz			47				63		mW
Global power-down			10	25			10	25	mW
Standby			185				185		mW

- (1) The maximum DRVDD current with CMOS interface depends on the actual load capacitance on the digital output lines. Note that the maximum recommended load capacitance on each digital output line is 10pF.
- (2) In CMOS mode, the DRVDD current scales with the sampling frequency, the load capacitance on output pins, input frequency, and the supply voltage (see the [CMOS Interface Power Dissipation](#) section in the [Application Information](#)).

DIGITAL CHARACTERISTICS

Typical values are at +25°C, AVDD = 1.8V, DRVDD = 1.8V, and 50% clock duty cycle, unless otherwise noted. Minimum and maximum values are across the full temperature range: T_{MIN} = -40°C to T_{MAX} = +85°C, AVDD = 1.8V, and DRVDD = 1.8V.

PARAMETER	TEST CONDITIONS	ADS4126, ADS4129, ADS4146, ADS4149			UNIT	
		MIN	TYP	MAX		
DIGITAL INPUTS (RESET, SCLK, SDATA, SEN, OE)						
High-level input voltage	RESET, SCLK, SDATA, and SEN support 1.8V and 3.3V CMOS logic levels	1.3			V	
Low-level input voltage				0.4	V	
High-level input voltage	OE only supports 1.8V CMOS logic levels	1.3			V	
Low-level input voltage				0.4	V	
High-level input current: SDATA, SCLK ⁽¹⁾	V _{HIGH} = 1.8V		10		μA	
High-level input current: SEN	V _{HIGH} = 1.8V		0		μA	
Low-level input current: SDATA, SCLK	V _{LOW} = 0V		0		μA	
Low-level input current: SEN	V _{LOW} = 0V		10		μA	
DIGITAL OUTPUTS (CMOS INTERFACE: D0 TO D13, OVR_SDOUT)						
High-level output voltage		DRVDD - 0.1	DRVDD		V	
Low-level output voltage			0	0.1	V	
DIGITAL OUTPUTS (LVDS INTERFACE: DA0P/M TO DA13P/M, DB0P/M TO DB13P/M, CLKOUTP/M)						
High-level output voltage ⁽²⁾	V _{ODH}	Standard swing LVDS	270	+350	430	mV
Low-level output voltage ⁽²⁾	V _{ODL}	Standard swing LVDS	-430	-350	-270	mV
High-level output voltage ⁽²⁾	V _{ODH}	Low swing LVDS		+200		mV
Low-level output voltage ⁽²⁾	V _{ODL}	Low swing LVDS		-200		mV
Output common-mode voltage	V _{OCM}		0.85	1.05	1.25	V

(1) SDATA and SCLK have an internal 180kΩ pull-down resistor.

(2) With an external 100Ω termination.

PIN CONFIGURATION (LVDS MODE)

**RGZ PACKAGE⁽¹⁾
QFN-48
(TOP VIEW)**

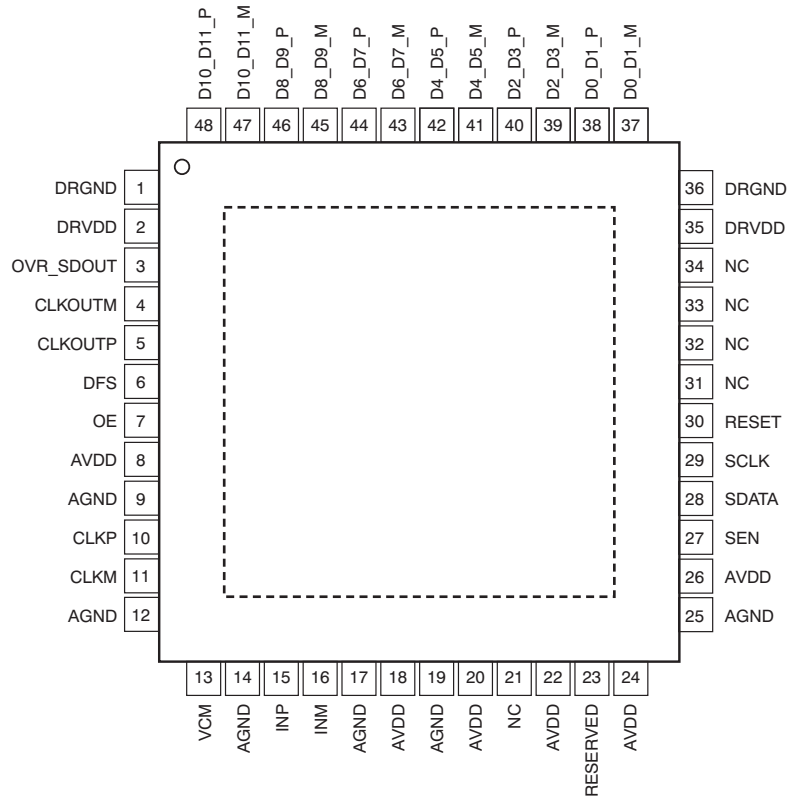

(1) The PowerPAD is connected to DRGND.

Figure 1. ADS412x LVDS Pinout

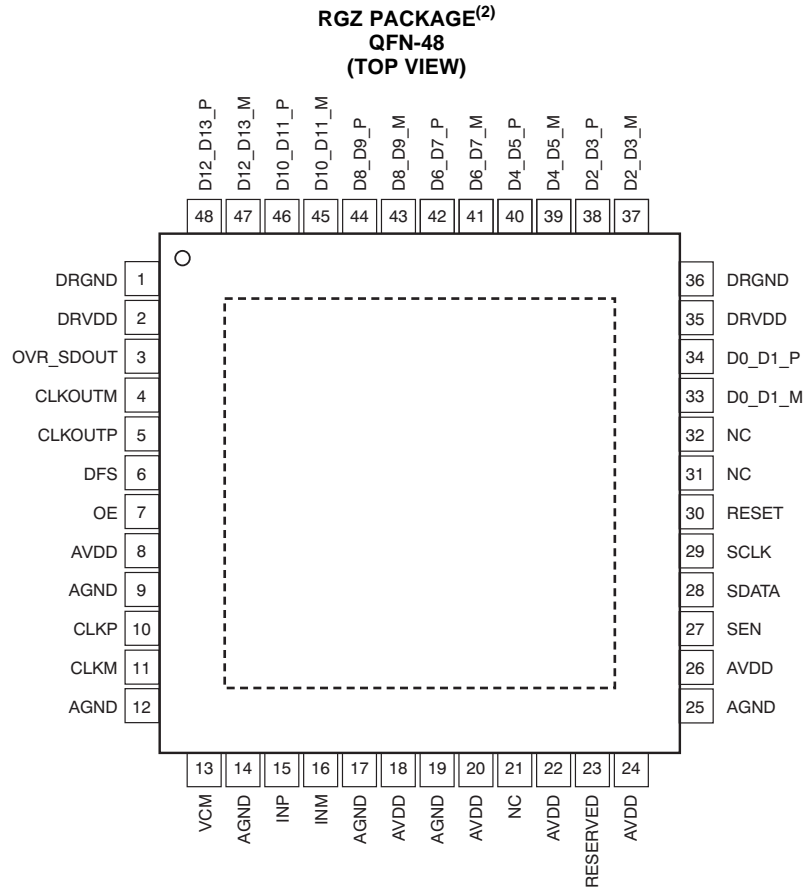

(2) The PowerPAD™ is connected to DRGND.

Figure 2. ADS414x LVDS Pinout

ADS412x, ADS414x Pin Assignments (LVDS Mode)

PIN NAME	PIN NUMBER	# OF PINS	FUNCTION	DESCRIPTION
AVDD	8, 18, 20, 22, 24, 26	6	I	1.8V analog power supply
AGND	9, 12, 14, 17, 19, 25	6	I	Analog ground
CLKP	10	1	I	Differential clock input, positive
CLKM	11	1	I	Differential clock input, negative
INP	15	1	I	Differential analog input, positive
INM	16	1	I	Differential analog input, negative
VCM	13	1	O	Outputs the common-mode voltage (0.95V) that can be used externally to bias the analog input pins.
RESET	30	1	I	Serial interface RESET input. When using the serial interface mode, the internal registers must initialize through hardware RESET by applying a high pulse on this pin or by using the software reset option; refer to the Serial Interface section. When RESET is tied high, the internal registers are reset to the default values. In this condition, SEN can be used as an analog control pin. RESET has an internal 180kΩ pull-down resistor.
SCLK	29	1	I	This pin functions as a serial interface clock input when RESET is low. When RESET is high, SCLK has no function and should be tied to ground. This pin has an internal 180kΩ pull-down resistor.
SDATA	28	1	I	This pin functions as a serial interface data input when RESET is low. When RESET is high, SDATA functions as a STANDBY control pin (see Table 9). This pin has an internal 180kΩ pull-down resistor.
SEN	27	1	I	This pin functions as a serial interface enable input when RESET is low. When RESET is high, SEN has no function and should be tied to AVDD. This pin has an internal 180kΩ pull-up resistor to AVDD.

ADS412x, ADS414x Pin Assignments (LVDS Mode) (continued)

PIN NAME	PIN NUMBER	# OF PINS	FUNCTION	DESCRIPTION
OE	7	1	I	Output buffer enable input, active high; this pin has an internal 180kΩ pull-up resistor to DRVDD.
DFS	6	1	I	Data format select input. This pin sets the DATA FORMAT (twos complement or offset binary) and the LVDS/CMOS output interface type. See Table 7 for detailed information.
RESERVED	23	1	I	Digital control pin, reserved for future use
CLKOUTP	5	1	O	Differential output clock, true
CLKOUTM	4	1	O	Differential output clock, complement
D0_D1_P	Refer to Figure 1 and Figure 2	1	O	Differential output data D0 and D1 multiplexed, true
D0_D1_M	Refer to Figure 1 and Figure 2	1	O	Differential output data D0 and D1 multiplexed, complement
D2_D3_P	Refer to Figure 1 and Figure 2	1	O	Differential output data D2 and D3 multiplexed, true
D2_D3_M	Refer to Figure 1 and Figure 2	1	O	Differential output data D2 and D3 multiplexed, complement
D4_D5_P	Refer to Figure 1 and Figure 2	1	O	Differential output data D4 and D5 multiplexed, true
D4_D5_M	Refer to Figure 1 and Figure 2	1	O	Differential output data D4 and D5 multiplexed, complement
D6_D7_P	Refer to Figure 1 and Figure 2	1	O	Differential output data D6 and D7 multiplexed, true
D6_D7_M	Refer to Figure 1 and Figure 2	1	O	Differential output data D6 and D7 multiplexed, complement
D8_D9_P	Refer to Figure 1 and Figure 2	1	O	Differential output data D8 and D9 multiplexed, true
D8_D9_M	Refer to Figure 1 and Figure 2	1	O	Differential output data D8 and D9 multiplexed, complement
D10_D11_P	Refer to Figure 1 and Figure 2	1	O	Differential output data D10 and D11 multiplexed, true
D10_D11_M	Refer to Figure 1 and Figure 2	1	O	Differential output data D10 and D11 multiplexed, complement
D12_D13_P	Refer to Figure 1 and Figure 2	1	O	Differential output data D12 and D13 multiplexed, true
D12_D13_M	Refer to Figure 1 and Figure 2	1	O	Differential output data D12 and D13 multiplexed, complement
OVR_SDOOUT	3	1	O	This pin functions as an out-of-range indicator after reset, when register bit READOUT = 0, and functions as a serial register readout pin when READOUT = 1.
DRVDD	2, 35	2	I	1.8V digital and output buffer supply
DRGND	1, 36, PAD	2	I	Digital and output buffer ground
NC	Refer to Figure 1 and Figure 2	—	—	Do not connect

PIN CONFIGURATION (CMOS MODE)

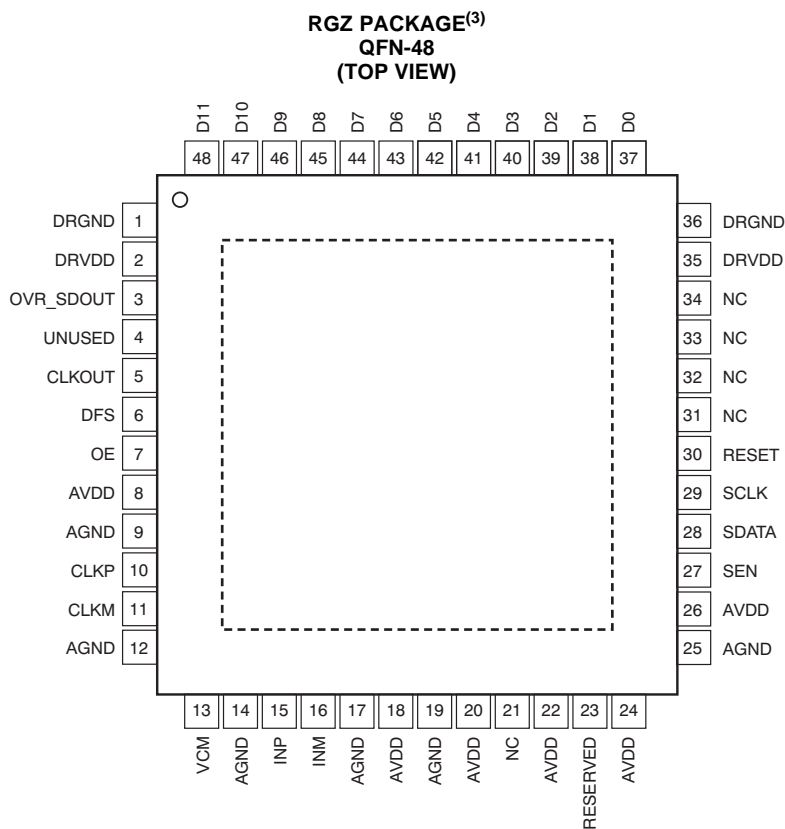

(3) The PowerPAD is connected to DRGND.

Figure 3. ADS412x CMOS Pinout

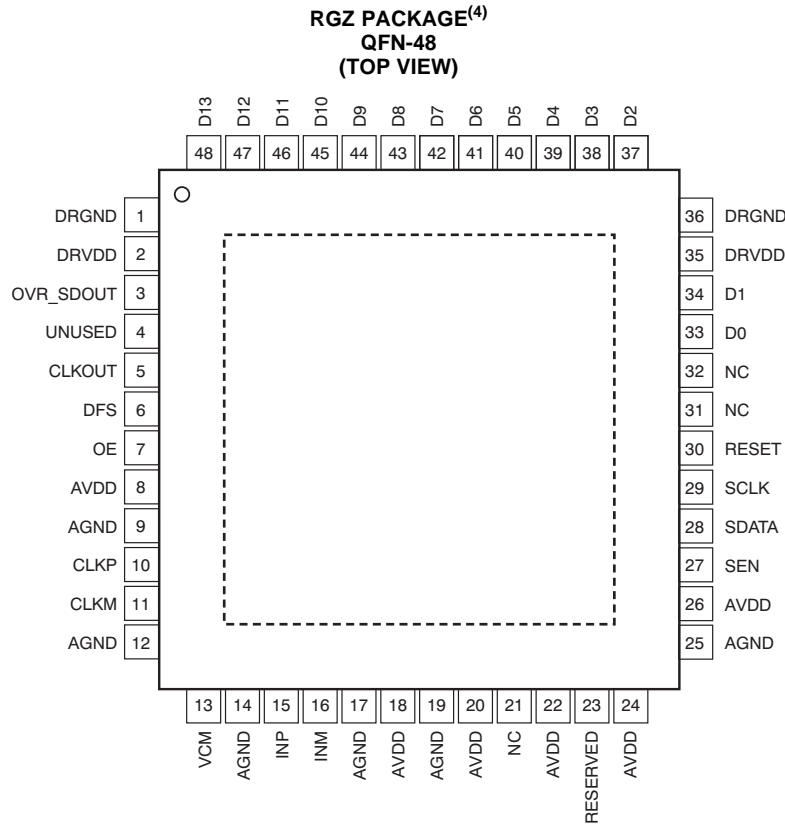

(4) The PowerPAD is connected to DRGND.

Figure 4. ADS414x CMOS Pinout

ADS412x, ADS414x Pin Assignments (CMOS Mode)

PIN NAME	PIN NUMBER	# OF PINS	FUNCTION	DESCRIPTION
AVDD	8, 18, 20, 22, 24, 26	6	I	1.8V analog power supply
AGND	9, 12, 14, 17, 19, 25	6	I	Analog ground
CLKP	10	1	I	Differential clock input, positive
CLKM	11	1	I	Differential clock input, negative
INP	15	1	I	Differential analog input, positive
INM	16	1	I	Differential analog input, negative
VCM	13	1	O	Outputs the common-mode voltage (0.95V) that can be used externally to bias the analog input pins.
RESET	30	1	I	Serial interface RESET input. When using the serial interface mode, the internal registers must initialize through hardware RESET by applying a high pulse on this pin or by using the software reset option; refer to the Serial Interface section. When RESET is tied high, the internal registers are reset to the default values. In this condition, SEN can be used as an analog control pin. RESET has an internal 180kΩ pull-down resistor.
SCLK	29	1	I	This pin functions as a serial interface clock input when RESET is low. When RESET is high, SCLK has no function and should be tied to ground. This pin has an internal 180kΩ pull-down resistor.
SDATA	28	1	I	This pin functions as a serial interface data input when RESET is low. When RESET is high, SDATA functions as a STANDBY control pin (see Table 9). This pin has an internal 180kΩ pull-down resistor.
SEN	27	1	I	This pin functions as a serial interface enable input when RESET is low. When RESET is high, SEN has no function and should be tied to AVDD. This pin has an internal 180kΩ pull-up resistor to AVDD.
OE	7	1	I	Output buffer enable input, active high; this pin has an internal 180kΩ pull-up resistor to DRVDD.

ADS412x, ADS414x Pin Assignments (CMOS Mode) (continued)

PIN NAME	PIN NUMBER	# OF PINS	FUNCTION	DESCRIPTION
DFS	6	1	I	Data format select input. This pin sets the DATA FORMAT (twos complement or offset binary) and the LVDS/CMOS output interface type. See Table 7 for detailed information.
RESERVED	23	1	I	Digital control pin, reserved for future use
CLKOUT	5	1	O	CMOS output clock
D0	Refer to Figure 3 and Figure 4	1	O	12-bit/14-bit CMOS output data
D1	Refer to Figure 3 and Figure 4	1	O	12-bit/14-bit CMOS output data
D2	Refer to Figure 3 and Figure 4	1	O	12-bit/14-bit CMOS output data
D3	Refer to Figure 3 and Figure 4	1	O	12-bit/14-bit CMOS output data
D4	Refer to Figure 3 and Figure 4	1	O	12-bit/14-bit CMOS output data
D5	Refer to Figure 3 and Figure 4	1	O	12-bit/14-bit CMOS output data
D6	Refer to Figure 3 and Figure 4	1	O	12-bit/14-bit CMOS output data
D7	Refer to Figure 3 and Figure 4	1	O	12-bit/14-bit CMOS output data
D8	Refer to Figure 3 and Figure 4	1	O	12-bit/14-bit CMOS output data
D9	Refer to Figure 3 and Figure 4	1	O	12-bit/14-bit CMOS output data
D10	Refer to Figure 3 and Figure 4	1	O	12-bit/14-bit CMOS output data
D11	Refer to Figure 3 and Figure 4	1	O	12-bit/14-bit CMOS output data
D12	Refer to Figure 3 and Figure 4	1	O	12-bit/14-bit CMOS output data
D13	Refer to Figure 3 and Figure 4	1	O	12-bit/14-bit CMOS output data
OVR_SDOUT	3	1	O	This pin functions as an out-of-range indicator after reset, when register bit READOUT = 0, and functions as a serial register readout pin when READOUT = 1.
DRVDD	2, 35	2	I	1.8V digital and output buffer supply
DRGND	1, 36, PAD	2	I	Digital and output buffer ground
UNUSED	4	1	—	Unused pin in CMOS mode
NC	Refer to Figure 3 and Figure 4	—	—	Do not connect

FUNCTIONAL BLOCK DIAGRAM

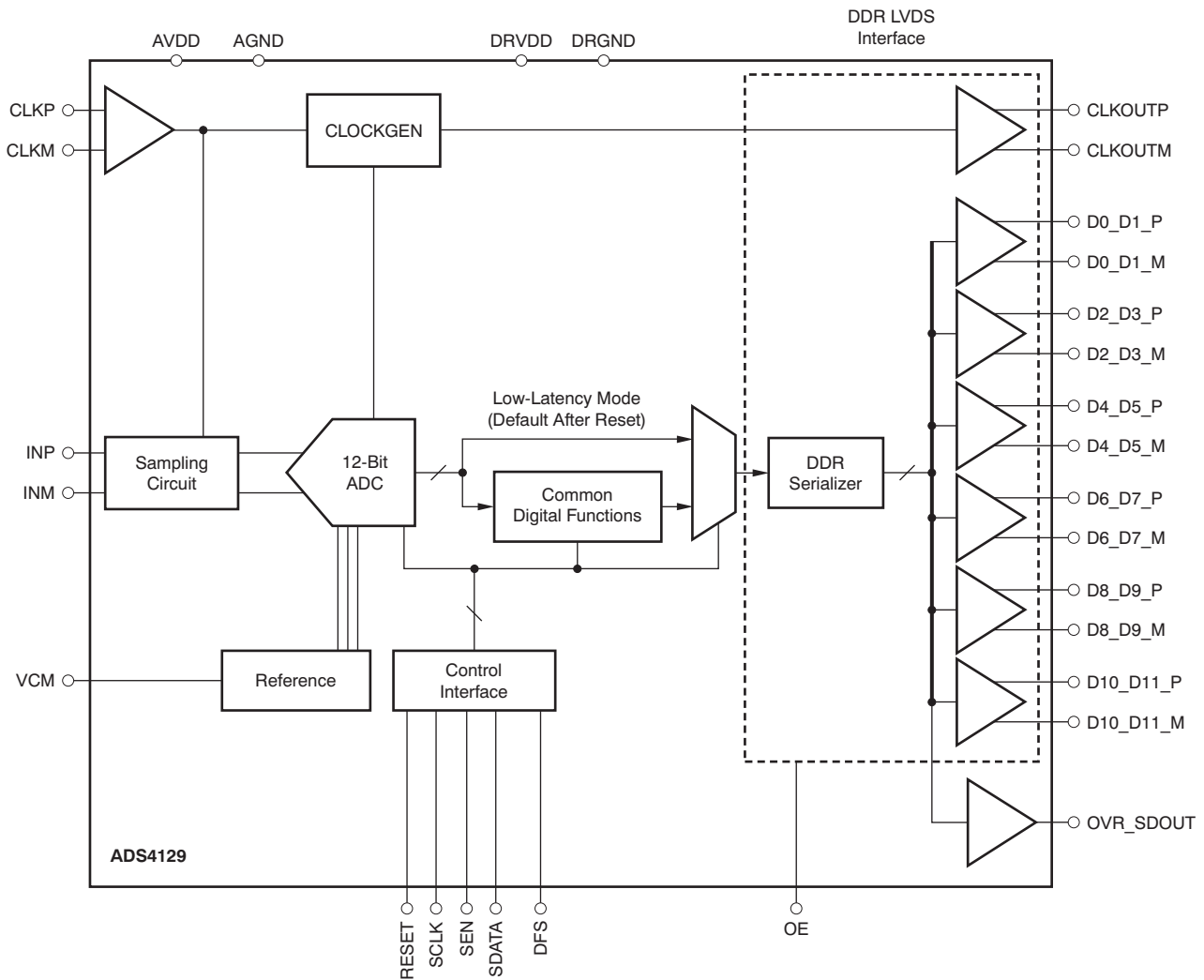

Figure 5. ADS412x Block Diagram

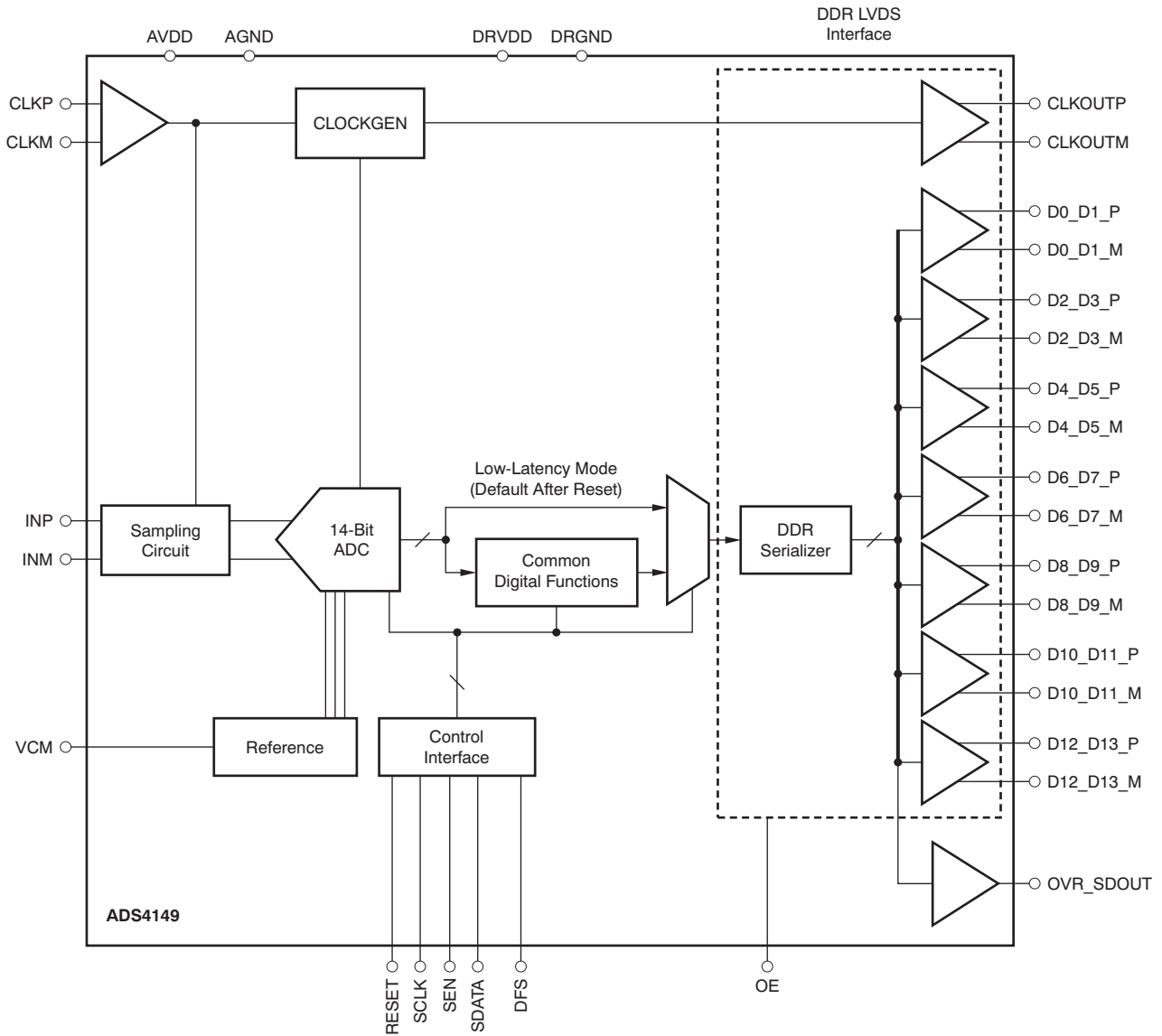
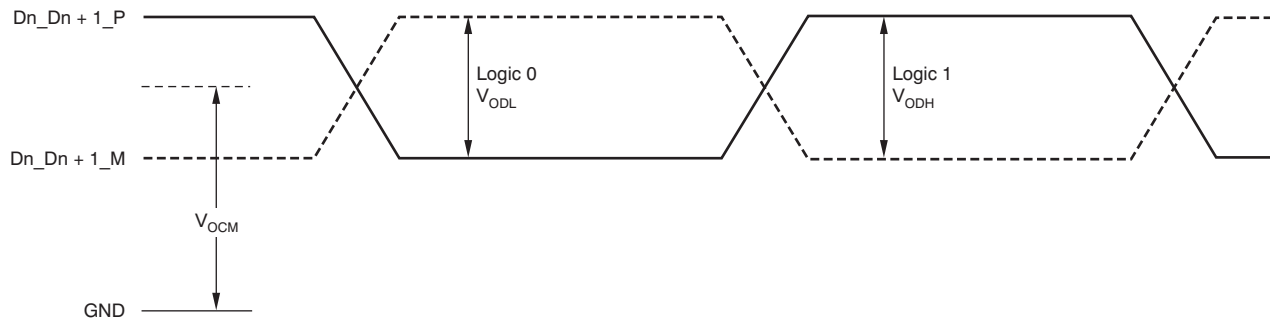

Figure 6. ADS414x Block Diagram

TIMING CHARACTERISTICS



(1) With external 100Ω termination.

Figure 7. LVDS Output Voltage Levels

TIMING REQUIREMENTS: LVDS and CMOS Modes⁽¹⁾

Typical values are at +25°C, AVDD = 1.8V, DRVDD = 1.8V, sampling frequency = 250 MSPS, sine wave input clock, C_{LOAD} = 5pF⁽²⁾, and R_{LOAD} = 100Ω⁽³⁾, unless otherwise noted. Minimum and maximum values are across the full temperature range: T_{MIN} = -40°C to T_{MAX} = +85°C, AVDD = 1.8V, and DRVDD = 1.7V to 1.9V.

PARAMETER	CONDITIONS	MIN	TYP	MAX	UNIT	
t _A	Aperture delay	0.6	0.8	1.2	ns	
	Variation of aperture delay		±100		ps	
t _J	Aperture jitter		100		f _S rms	
Wakeup time	Time to valid data after coming out of STANDBY mode		5	25	μs	
	Time to valid data after coming out of PDN GLOBAL mode		100	500	μs	
ADC latency ⁽⁴⁾	Low-latency mode (default after reset)		10		Clock cycles	
	Low-latency mode disabled (gain enabled, offset correction disabled)		16		Clock cycles	
	Low-latency mode disabled (gain and offset correction enabled)		17		Clock cycles	
DDR LVDS MODE⁽⁵⁾⁽⁶⁾						
t _{SU}	Data setup time ⁽³⁾	Data valid ⁽⁷⁾ to zero-crossing of CLKOUTP	0.75	1.1	ns	
t _H	Data hold time ⁽³⁾	Zero-crossing of CLKOUTP to data becoming invalid ⁽⁷⁾	0.35	0.6	ns	
t _{PDI}	Clock propagation delay	Input clock rising edge cross-over to output clock rising edge cross-over 1MSPS ≤ sampling frequency ≤ 250MSPS	3	4.2	5.4	ns
	Variation of t _{PDI}	Between two devices at the same temperature and DRVDD supply		±0.6		ns

(1) Timing parameters are ensured by design and characterization but are not production tested.

(2) C_{LOAD} is the effective external single-ended load capacitance between each output pin and ground.

(3) R_{LOAD} is the differential load resistance between the LVDS output pair.

(4) At higher frequencies, t_{PDI} is greater than one clock period and overall latency = ADC latency + 1.

(5) Measurements are done with a transmission line of 100Ω characteristic impedance between the device and the load. Setup and hold time specifications take into account the effect of jitter on the output data and clock.

(6) The LVDS timings are unchanged for low latency disabled and enabled.

(7) Data valid refers to a logic high of 1.26V and a logic low of 0.54V.

TIMING REQUIREMENTS: LVDS and CMOS Modes⁽¹⁾ (continued)

Typical values are at +25°C, AVDD = 1.8V, DRVDD = 1.8V, sampling frequency = 250 MSPS, sine wave input clock, C_{LOAD} = 5pF⁽²⁾, and R_{LOAD} = 100Ω⁽³⁾, unless otherwise noted. Minimum and maximum values are across the full temperature range: T_{MIN} = -40°C to T_{MAX} = +85°C, AVDD = 1.8V, and DRVDD = 1.7V to 1.9V.

PARAMETER	CONDITIONS	MIN	TYP	MAX	UNIT
DDR LVDS MODE (continued)					
LVDS bit clock duty cycle	Duty cycle of differential clock, (CLKOUTP – CLKOUTM) 1MSPS ≤ sampling frequency ≤ 250MSPS	42	48	54	%
t _{RISE} , t _{FALL}	Data rise time, Data fall time		0.14		ns
t _{CLKRISE} , t _{CLKFALL}	Output clock rise time, Output clock fall time		0.14		ns
t _{OE}	Output enable (OE) to data delay		50	100	ns
PARALLEL CMOS MODE⁽⁸⁾⁽⁹⁾					
t _{START}	Input clock to data delay			1.1	ns
t _{DV}	Data valid time	2.5	3.2		ns
t _{PDI}	Clock propagation delay	4	5.5	7	ns
Output clock duty cycle	Duty cycle of output clock, CLKOUT 1MSPS ≤ sampling frequency ≤ 200MSPS		47		%
t _{RISE} , t _{FALL}	Data rise time, Data fall time		0.35		ns
t _{CLKRISE} , t _{CLKFALL}	Output clock rise time, Output clock fall time		0.35		ns
t _{OE}	Output enable (OE) to data delay		20	40	ns

(8) For f_S > 200MSPS, it is recommended to use an external clock for data capture instead of the device output clock signal (CLKOUT).

(9) Low latency mode enabled.

(10) Data valid refers to a logic high of 1.26V and a logic low of 0.54V.

Table 2. LVDS Timing Across Sampling Frequencies

SAMPLING FREQUENCY (MSPS)	SETUP TIME (ns)			HOLD TIME (ns)		
	MIN	TYP	MAX	MIN	TYP	MAX
230	0.85	1.25		0.35	0.6	
200	1.05	1.55		0.35	0.6	
185	1.1	1.7		0.35	0.6	
160	1.6	2.1		0.35	0.6	
125	2.3	3		0.35	0.6	
80	4.5	5.2		0.35	0.6	

Table 3. CMOS Timing Across Sampling Frequencies (Low Latency Enabled)

SAMPLING FREQUENCY (MSPS)	TIMING SPECIFIED WITH RESPECT TO OUTPUT CLOCK								
	t _{SETUP} (ns)			t _{HOLD} (ns)			t _{PDI} (ns)		
	MIN	TYP	MAX	MIN	TYP	MAX	MIN	TYP	MAX
200	1.6	2.2		1.8	2.5		4	5.5	7
185	1.8	2.4		1.9	2.7		4	5.5	7
160	2.3	2.9		2.2	3		4	5.5	7
125	3.1	3.7		3.2	4		4	5.5	7
80	5.4	6		5.4	6		4	5.5	7

Table 4. CMOS Timing Across Sampling Frequencies (Low Latency Disabled)

SAMPLING FREQUENCY (MSPS)	TIMING SPECIFIED WITH RESPECT TO OUTPUT CLOCK								
	t _{SETUP} (ns)			t _{HOLD} (ns)			t _{PDI} (ns)		
	MIN	TYP	MAX	MIN	TYP	MAX	MIN	TYP	MAX
200	1	1.6		2	2.8		4	5.5	7
185	1.3	2		2.2	3		4	5.5	7
160	1.8	2.5		2.5	3.3		4	5.5	7
125	2.5	3.2		3.5	4.3		4	5.5	7
80	4.8	5.5		5.7	6.5		4	5.5	7

Table 5. CMOS Timing Across Sampling Frequencies (Low Latency Enabled)

SAMPLING FREQUENCY (MSPS)	TIMING SPECIFIED WITH RESPECT TO INPUT CLOCK					
	t _{START} (ns)			t _{DV} (ns)		
	MIN	TYP	MAX	MIN	TYP	MAX
250			1.1	2.5	3.2	
230			0.7	2.9	3.5	
200			-0.3	3.5	4.2	
185			-1	3.9	4.5	
170			-1.5	4.3	5	

Table 6. CMOS Timing Across Sampling Frequencies (Low Latency Disabled)

SAMPLING FREQUENCY (MSPS)	TIMING SPECIFIED WITH RESPECT TO INPUT CLOCK					
	t_{START} (ns)			t_{DV} (ns)		
	MIN	TYP	MAX	MIN	TYP	MAX
250			1.6	2.5	3.2	
230			1.1	2.9	3.5	
200			0.3	3.5	4.2	
185			0	3.9	4.5	
170			-1.3	4.3	5	

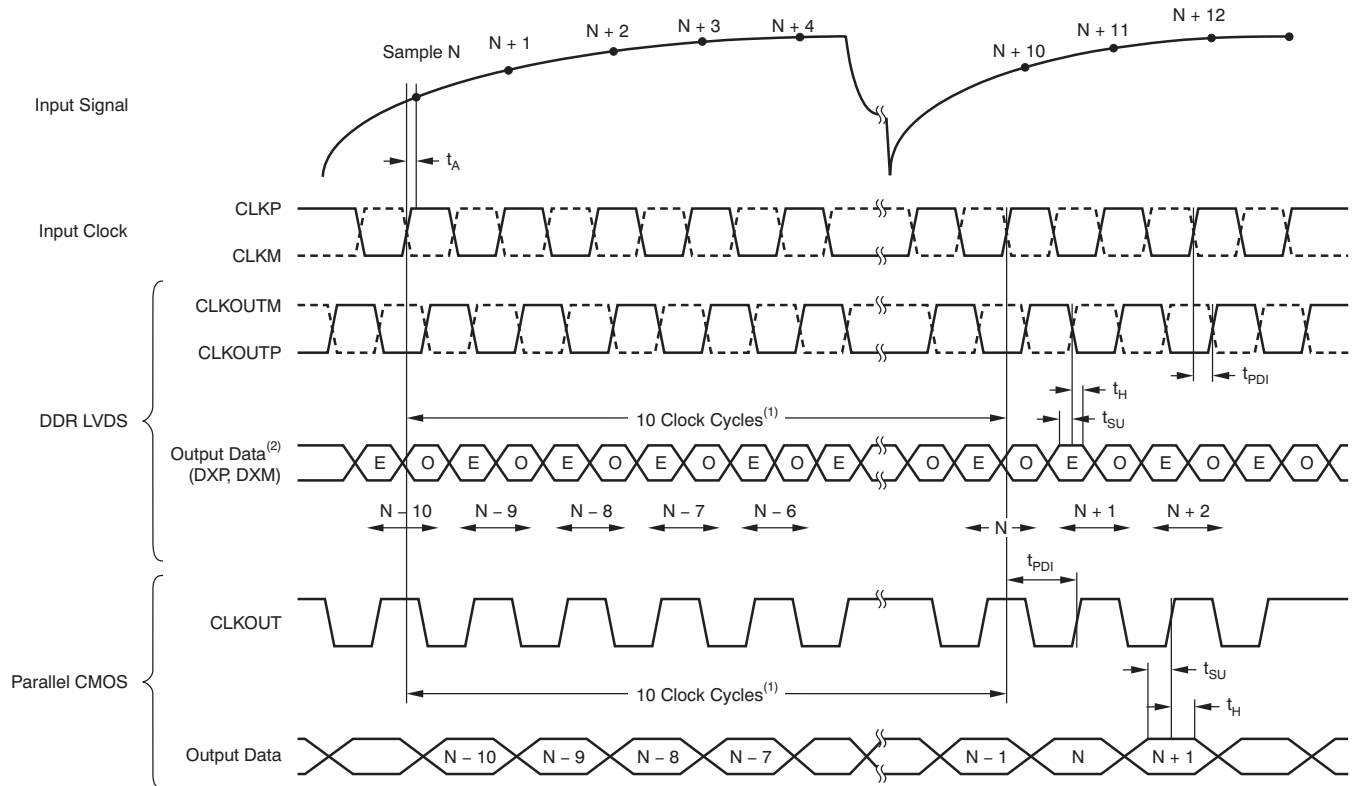

(1) ADC latency in low-latency mode. At higher sampling frequencies, t_{PD1} is greater than one clock cycle which then makes the overall latency = ADC latency + 1.

(2) E = Even bits (D0, D2, D4, etc). O = Odd bits (D1, D3, D5, etc).

Figure 8. Latency Diagram

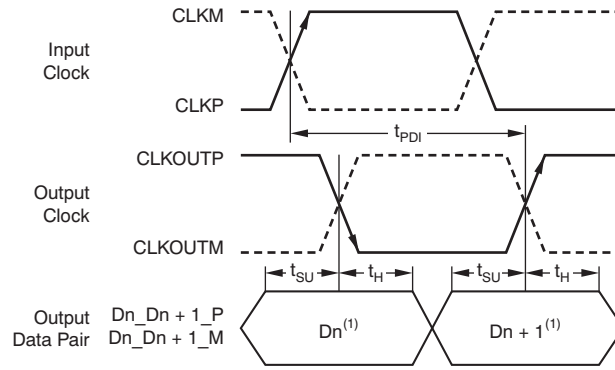

(1) D_n = bits D0, D2, D4, etc. D_{n+1} = Bits D1, D3, D5, etc.

Figure 9. LVDS Mode Timing

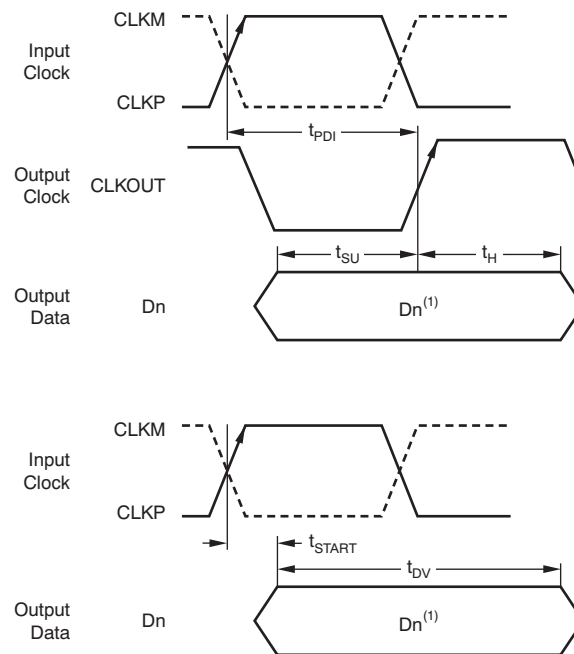

D_n = bits D0, D1, D2, etc.

Figure 10. CMOS Mode Timing

DEVICE CONFIGURATION

The ADS412x/4x have several modes that can be configured using a serial programming interface, as described in [Table 7](#), [Table 8](#), and [Table 9](#). In addition, the devices have two dedicated parallel pins for quickly configuring commonly used functions. The parallel pins are DFS (analog 4-level control pin) and OE (digital control pin). The analog control pins can be easily configured using a simple resistor divider (with 10% tolerance resistors).

Table 7. DFS: Analog Control Pin

VOLTAGE APPLIED ON DFS	DESCRIPTION (Data Format/Output Interface)
0, +100mV/-0mV	Twos complement/DDR LVDS
(3/8) AVDD ± 100mV	Twos complement/parallel CMOS
(5/8) AVDD ± 100mV	Offset binary/parallel CMOS
AVDD, +0mV/-100mV	Offset binary/DDR LVDS

Table 8. OE: Digital Control Pin

VOLTAGE APPLIED ON OE	DESCRIPTION
0	Output data buffers disabled
AVDD	Output data buffers enabled

When the serial interface is not used, the SDATA pin can also be used as a digital control pin to place the device in standby mode. To enable this, the RESET pin must be tied high. In this mode, SEN and SCLK do not have any alternative functions. Keep SEN tied high and SCLK tied low on the board.

Table 9. SDATA: Digital Control Pin

VOLTAGE APPLIED ON SDATA	DESCRIPTION
0	Normal operation
Logic high	Device enters standby

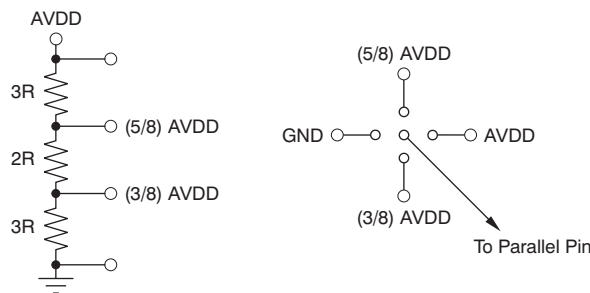

Figure 11. Simplified Diagram to Configure DFS Pin

SERIAL INTERFACE

The analog-to-digital converter (ADC) has a set of internal registers that can be accessed by the serial interface formed by the SEN (serial interface enable), SCLK (serial interface clock), and SDATA (serial interface data) pins. Serial shift of bits into the device is enabled when SEN is low. Serial data SDATA are latched at every falling edge of SCLK when SEN is active (low). The serial data are loaded into the register at every 16th SCLK falling edge when SEN is low. In case the word length exceeds a multiple of 16 bits, the excess bits are ignored. Data can be loaded in multiples of 16-bit words within a single active SEN pulse. The first eight bits form the register address and the remaining eight bits are the register data. The interface can work with SCLK frequency from 20MHz down to very low speeds (a few Hertz) and also with non-50% SCLK duty cycle.

Register Initialization

After power-up, the internal registers must be initialized to the default values. This initialization can be accomplished in one of two ways:

1. Either through hardware reset by applying a high pulse on RESET pin (of width greater than 10ns), as shown in Figure 12; or
2. By applying a software reset. When using the serial interface, set the RESET bit (D7 in register 00h) high. This setting initializes the internal registers to the default values and then self-resets the RESET bit low. In this case, the RESET pin is kept low.

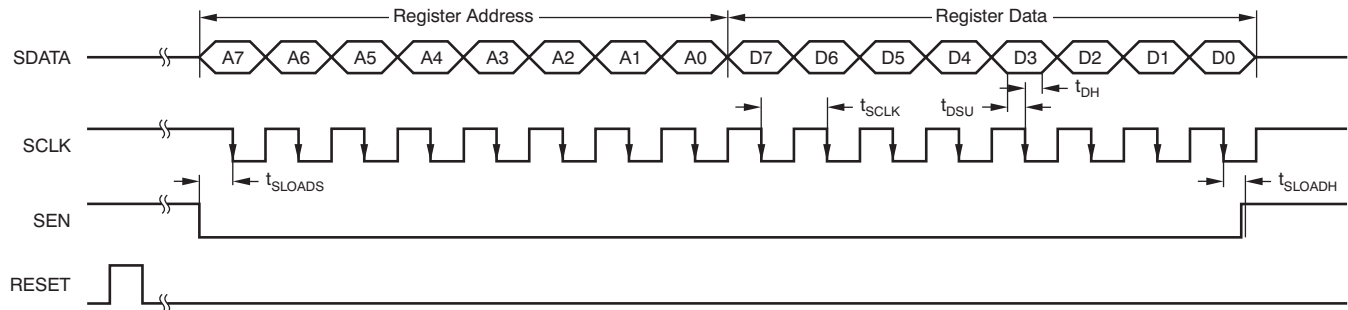

Figure 12. Serial Interface Timing

SERIAL INTERFACE TIMING CHARACTERISTICS

Typical values at +25°C, minimum and maximum values across the full temperature range: $T_{MIN} = -40^{\circ}C$ to $T_{MAX} = +85^{\circ}C$, AVDD = 1.8V, and DRVDD = 1.8V, unless otherwise noted.

PARAMETER		MIN	TYP	MAX	UNIT
f_{SCLK}	SCLK frequency (equal to $1/t_{SCLK}$)	> dc		20	MHz
t_{SLOADS}	SEN to SCLK setup time	25			ns
t_{SLOADH}	SCLK to SEN hold time	25			ns
t_{DSU}	SDATA setup time	25			ns
t_{DH}	SDATA hold time	25			ns

Serial Register Readout

The serial register readout function allows the contents of the internal registers to be read back on the OVR_SDOUT pin. This readback may be useful as a diagnostic check to verify the serial interface communication between the external controller and the ADC.

After power-up and device reset, the OVR_SDOUT pin functions as an over-range indicator pin by default. When the readout mode is enabled, OVR_SDOUT outputs the contents of the selected register serially:

1. Set the READOUT register bit to '1'. This setting puts the device in serial readout mode and disables any further writes to the internal registers **except** the register at address 0. Note that the READOUT bit itself is also located in register 0. The device can exit readout mode by writing READOUT = 0. Only the contents of the register at address 0 cannot be read in the register readout mode.
2. Initiate a serial interface cycle specifying the address of the register (A7 to A0) whose content has to be read.
3. The device serially outputs the contents (D7 to D0) of the selected register on the OVR_SDOUT pin.
4. The external controller can latch the contents at the falling edge of SCLK.
5. To exit the serial readout mode, the reset register bit READOUT = 0 enables writes into all registers of the device. At this point, the OVR_SDOUT pin becomes an over-range indicator pin.

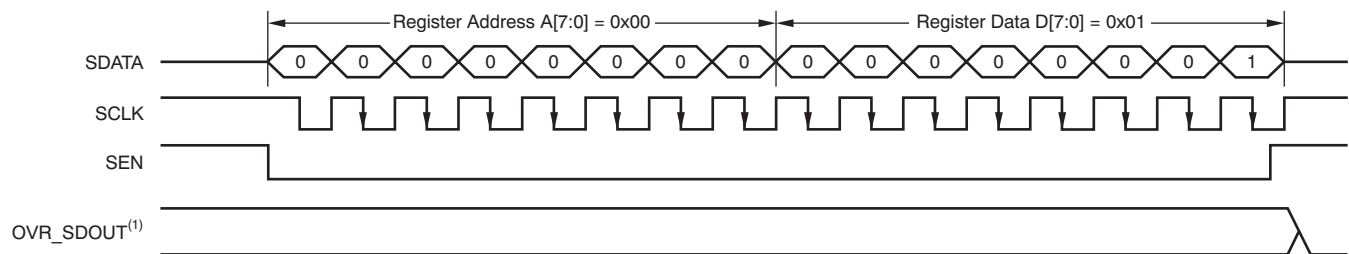

a) Enable Serial Readout (READOUT = 1)

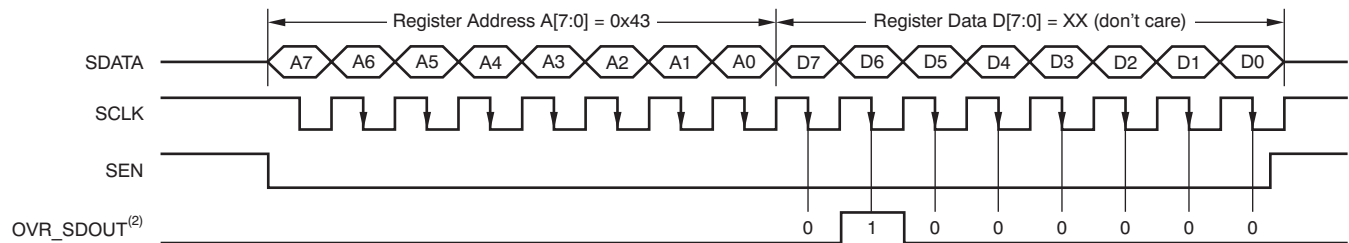

b) Read Contents of Register 0x43. This Register Has Been Initialized with 0x40 (device is put in global power-down mode).

(1) The OVR_SDOUT pin functions as OVR (READOUT = 0).

(2) The OVR_SDOUT pin functions as a serial readout (READOUT = 1).

Figure 13. Serial Readout Timing Diagram

RESET TIMING CHARACTERISTICS

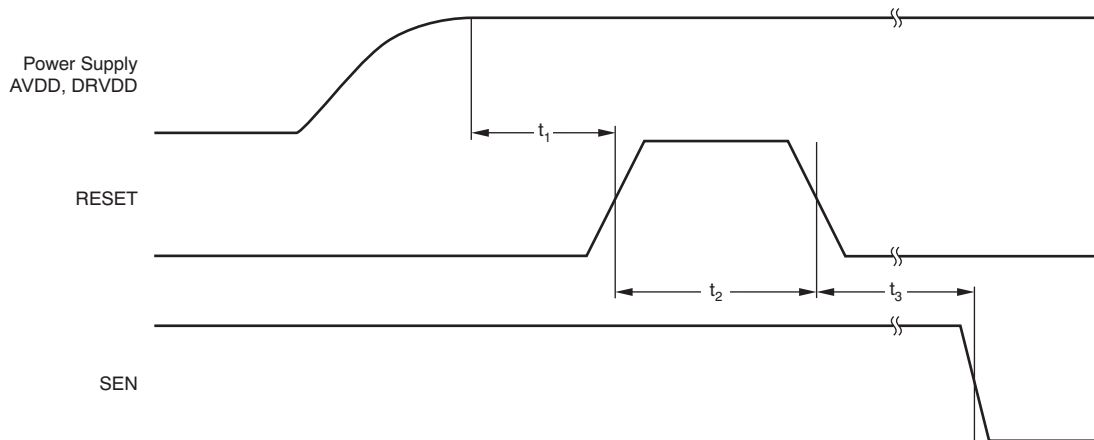

NOTE: A high pulse on the RESET pin is required in the serial interface mode in case of initialization through hardware reset. For parallel interface operation, RESET must be permanently tied high.

Figure 14. Reset Timing Diagram

RESET TIMING REQUIREMENTS

Typical values at +25°C and minimum and maximum values across the full temperature range: $T_{MIN} = -40^{\circ}C$ to $T_{MAX} = +85^{\circ}C$, unless otherwise noted.

PARAMETER	TEST CONDITIONS	MIN	TYP	MAX	UNIT
t_1	Power-on delay	Delay from power-up of AVDD and DRVDD to RESET pulse active		1	ms
t_2	Reset pulse width	Pulse width of active RESET signal that resets the serial registers		10	ns
				1 ⁽¹⁾	μs
t_3		Delay from RESET disable to SEN active		100	ns

(1) The reset pulse is needed only when using the serial interface configuration. If the pulse width is greater than 1 μs , the device could enter the parallel configuration mode briefly and then return back to serial interface mode.

SERIAL REGISTER MAP

Table 10 summarizes the functions supported by the serial interface.

Table 10. Serial Interface Register Map⁽¹⁾

REGISTER ADDRESS	DEFAULT VALUE AFTER RESET	REGISTER DATA								
A[7:0] (Hex)	D[7:0] (Hex)	D7	D6	D5	D4	D3	D2	D1	D0	
00	00	0	0	0	0	0	0	RESET	READOUT	
01	00	LVDS SWING							0	0
03	00	0	0	0	0	0	0	HIGH PERF MODE 1		
25	00	GAIN				DISABLE GAIN	TEST PATTERNS			
26	00	0	0	0	0	0	0	LVDS CLKOUT STRENGTH	LVDS DATA STRENGTH	
3D	00	DATA FORMAT		EN OFFSET CORR	0	0	0	0	0	
3F	00	CUSTOM PATTERN HIGH D[13:6]								
40	00	CUSTOM PATTERN D[5:0]							0	0
41	00	LVDS CMOS		CMOS CLKOUT STRENGTH		EN CLKOUT RISE	CLKOUT RISE POSN		EN CLKOUT FALL	
42	00	CLKOUT FALL POSN		0	0	DIS LOW LATENCY	STBY	0	0	
43	00	0	PDN GLOBAL	0	PDN OBUF	0	0	EN LVDS SWING		
4A	00	0	0	0	0	0	0	0	HIGH PERF MODE 2	
BF	00	OFFSET PEDESTAL							0	0
CF	00	FREEZE OFFSET CORR	0	OFFSET CORR TIME CONSTANT				0	0	
DF	00	0	0	LOW SPEED		0	0	0	0	

(1) Multiple functions in a register can be programmed in a single write operation.

DESCRIPTION OF SERIAL REGISTERS

For best performance, two special mode register bits must be enabled: HI PERF MODE 1 and HI PERF MODE 2.

Register Address 00h (Default = 00h)

7	6	5	4	3	2	1	0
0	0	0	0	0	0	RESET	READOUT

Bits[7:2] Always write '0'

Bit 1 RESET: Software reset applied

This bit resets all internal registers to the default values and self-clears to 0 (default = 1).

Bit 0 READOUT: Serial readout

This bit sets the serial readout of the registers.

0 = Serial readout of registers disabled; the OVR_SDOOUT pin functions as an over-voltage indicator.

1 = Serial readout enabled; the OVR_SDOOUT pin functions as a serial data readout.

Register Address 01h (Default = 00h)

7	6	5	4	3	2	1	0
LVDS SWING						0	0

Bits[7:2] LVDS SWING: LVDS swing programmability⁽¹⁾

000000 = Default LVDS swing; $\pm 350\text{mV}$ with external 100Ω termination

011011 = LVDS swing *increases* to $\pm 410\text{mV}$

110010 = LVDS swing *increases* to $\pm 465\text{mV}$

010100 = LVDS swing *increases* to $\pm 570\text{mV}$

111110 = LVDS swing *decreases* to $\pm 200\text{mV}$

001111 = LVDS swing *decreases* to $\pm 125\text{mV}$

Bits[1:0] Always write '0'

(1) The EN LVDS SWING register bits must be set to enable LVDS swing control.

Register Address 03h (Default = 00h)

7	6	5	4	3	2	1	0
0	0	0	0	0	0	HI PERF MODE 1	

Bits[7:2] Always write '0'
Bits[1:0] HI PERF MODE 1: High performance mode 1

00 = Default performance after reset

01 = Do not use

10 = Do not use

11 = For best performance across sampling clock and input signal frequencies, set the HIGH PERF MODE 1 bits

Register Address 25h (Default = 00h)

7	6	5	4	3	2	1	0
GAIN				DISABLE GAIN	TEST PATTERNS		

Bits[7:4] GAIN: Gain programmability

These bits set the gain programmability in 0.5dB steps.

0000 = 0dB gain (default after reset)	0111 = 3.5dB gain
0001 = 0.5dB gain	1000 = 4.0dB gain
0010 = 1.0dB gain	1001 = 4.5dB gain
0011 = 1.5dB gain	1010 = 5.0dB gain
0100 = 2.0dB gain	1011 = 5.5dB gain
0101 = 2.5dB gain	1100 = 6dB gain
0110 = 3.0dB gain	

Bit 3 DISABLE GAIN: Gain setting

This bit sets the gain.

- 0 = Gain enabled; gain is set by the GAIN bits only if low-latency mode is disabled
- 1 = Gain disabled

Bits[2:0] TEST PATTERNS: Data capture

These bits verify data capture.

- 000 = Normal operation
- 001 = Outputs all 0s
- 010 = Outputs all 1s
- 011 = Outputs toggle pattern

In the ADS4146/49, output data D[13:0] is an alternating sequence of *01010101010101* and *10101010101010*.

In the ADS4126/29, output data D[11:0] is an alternating sequence of *010101010101* and *101010101010*.

100 = Outputs digital ramp

In ADS4149/46, output data increments by one LSB (14-bit) every clock cycle from code 0 to code 16383

In ADS4129/26, output data increments by one LSB (12-bit) every 4th clock cycle from code 0 to code 4095

- 101 = Output custom pattern (use registers 3Fh and 40h for setting the custom pattern)
- 110 = Unused
- 111 = Unused

Register Address 26h (Default = 00h)

7	6	5	4	3	2	1	0
0	0	0	0	0	0	LVDS CLKOUT STRENGTH	LVDS DATA STRENGTH

Bits[7:2] Always write '0'

Bit 1 LVDS CLKOUT STRENGTH: LVDS output clock buffer strength

This bit determines the external termination to be used with the LVDS output clock buffer.
 0 = 100Ω external termination (default strength)
 1 = 50Ω external termination (2x strength)

Bit 0 LVDS DATA STRENGTH: LVDS data buffer strength

This bit determines the external termination to be used with all of the LVDS data buffers.
 0 = 100Ω external termination (default strength)
 1 = 50Ω external termination (2x strength)

Register Address 3Dh (Default = 00h)

7	6	5	4	3	2	1	0
DATA FORMAT		EN OFFSET CORR	0	0	0	0	0

Bits[7:6] DATA FORMAT: Data format selection

These bits selects the data format.
 00 = The DFS pin controls data format selection
 10 = Twos complement
 11 = Offset binary

Bit 5 ENABLE OFFSET CORR: Offset correction setting

This bit sets the offset correction.
 0 = Offset correction disabled
 1 = Offset correction enabled

Bits[4:0] Always write '0'

Register Address 3Fh (Default = 00h)

7	6	5	4	3	2	1	0
CUSTOM PATTERN D13	CUSTOM PATTERN D12	CUSTOM PATTERN D11	CUSTOM PATTERN D10	CUSTOM PATTERN D9	CUSTOM PATTERN D8	CUSTOM PATTERN D7	CUSTOM PATTERN D6

Bits[7:0] CUSTOM PATTERN⁽¹⁾

These bits set the custom pattern.

(1) For the ADS414x, output data bits 13 to 0 are CUSTOM PATTERN D[13:0]. For the ADS412x, output data bits 11 to 0 are CUSTOM PATTERN D[13:2].

Register Address 40h (Default = 00h)

7	6	5	4	3	2	1	0
CUSTOM PATTERN D5	CUSTOM PATTERN D4	CUSTOM PATTERN D3	CUSTOM PATTERN D2	CUSTOM PATTERN D1	CUSTOM PATTERN D0	0	0

Bits[7:2] CUSTOM PATTERN⁽¹⁾

These bits set the custom pattern.

Bits[1:0] Always write '0'

(1) For the ADS414x, output data bits 13 to 0 are CUSTOM PATTERN D[13:0]. For the ADS412x, output data bits 11 to 0 are CUSTOM PATTERN D[13:2].

Register Address 41h (Default = 00h)

7	6	5	4	3	2	1	0
LVDS CMOS		CMOS CLKOUT STRENGTH		EN CLKOUT RISE	CLKOUT RISE POSN		EN CLKOUT FALL

Bits[7:6] LVDS CMOS: Interface selection

These bits select the interface.

- 00 = The DFS pin controls the selection of either LVDS or CMOS interface
- 10 = The DFS pin controls the selection of either LVDS or CMOS interface
- 01 = DDR LVDS interface
- 11 = Parallel CMOS interface

Bits[5:4] CMOS CLKOUT STRENGTH

Controls strength of CMOS output clock only.

- 00 = Maximum strength (recommended and used for specified timings)
- 01 = Medium strength
- 10 = Low strength
- 11 = Very low strength

Bit 3 ENABLE CLKOUT RISE

- 0 = Disables control of output clock rising edge
- 1 = Enables control of output clock rising edge

Bits[2:1] CLKOUT RISE POSN: CLKOUT rise control

Controls position of output clock rising edge

LVDS interface:

- 00 = Default position (timings are specified in this condition)
- 01 = Setup reduces by 500ps, hold increases by 500ps
- 10 = Data transition is aligned with rising edge
- 11 = Setup reduces by 200ps, hold increases by 200ps

CMOS interface:

- 00 = Default position (timings are specified in this condition)
- 01 = Setup reduces by 100ps, hold increases by 100ps
- 10 = Setup reduces by 200ps, hold increases by 200ps
- 11 = Setup reduces by 1.5ns, hold increases by 1.5ns

Bit 0 ENABLE CLKOUT FALL

- 0 = Disables control of output clock fall edge
- 1 = Enables control of output clock fall edge

Register Address 42h (Default = 00h)

7	6	5	4	3	2	1	0
CLKOUT FALL CTRL		0	0	DIS LOW LATENCY	STBY	0	0

Bits[7:6] CLKOUT FALL CTRL

Controls position of output clock falling edge

LVDS interface:

00 = Default position (timings are specified in this condition)

01 = Setup reduces by 400ps, hold increases by 400ps

10 = Data transition is aligned with rising edge

11 = Setup reduces by 200ps, hold increases by 200ps

CMOS interface:

00 = Default position (timings are specified in this condition)

01 = Falling edge is advanced by 100ps

10 = Falling edge is advanced by 200ps

11 = Falling edge is advanced by 1.5ns

Bits[5:4] Always write '0'
Bit 3 DIS LOW LATENCY: Disable low latency

This bit disables low-latency mode,

0 = Low latency mode is enabled. Digital functions such as gain, test patterns and offset correction are disabled

1 = Low-latency mode is disabled. This setting enables the digital functions. See the [Digital Functions and Low Latency Mode](#) section.

Bit 2 STBY: Standby mode

This bit sets the standby mode.

0 = Normal operation

1 = Only the ADC and output buffers are powered down; internal reference is active; wake-up time from standby is fast

Bits[1:0] Always write '0'

Register Address 43h (Default = 00h)

7	6	5	4	3	2	1	0
0	PDN GLOBAL	0	PDN OBUF	0	0	EN LVDS SWING	

Bit 0 Always write '0'

Bit 6 **PDN GLOBAL: Power-down**

This bit sets the state of operation.

0 = Normal operation

1 = Total power down; the ADC, internal references, and output buffers are powered down; slow wake-up time.

Bit 5 Always write '0'

Bit 4 **PDN OBUF: Power-down output buffer**

This bit set the output data and clock pins.

0 = Output data and clock pins enabled

1 = Output data and clock pins powered down and put in high- impedance state

Bits[3:2] Always write '0'

Bits[1:0] **EN LVDS SWING: LVDS swing control**

00 = LVDS swing control using LVDS SWING register bits is disabled

01 = Do not use

10 = Do not use

11 = LVDS swing control using LVDS SWING register bits is enabled

Register Address 4Ah (Default = 00h)

7	6	5	4	3	2	1	0
0	0	0	0	0	0	0	HI PERF MODE 2

Bits[7:1] Always write '0'

Bit[0] **HI PERF MODE 2: High performance mode 2**

This bit is recommended for high input signal frequencies greater than 230MHz.

0 = Default performance after reset

1 = For best performance with high-frequency input signals, set the HIGH PERF MODE 2 bit

Register Address BFh (Default = 00h)

7	6	5	4	3	2	1	0
OFFSET PEDESTAL						0	0

Bits[7:2] OFFSET PEDESTAL

These bits set the offset pedestal.

When the offset correction is enabled, the final converged value after the offset is corrected is the ADC mid-code value. A pedestal can be added to the final converged value by programming these bits.

ADS414x VALUE
PEDESTAL

011111

31LSB

011110

30LSB

011101

29LSB

—

—

000000

0LSB

—

—

111111

-1LSB

111110

-2LSB

—

—

100000

-32LSB

Bits[1:0] Always write '0'

Register Address CFh (Default = 00h)

7	6	5	4	3	2	1	0
FREEZE OFFSET CORR	BYPASS OFFSET CORR	OFFSET CORR TIME CONSTANT				0	0

Bit 7 FREEZE OFFSET CORR

This bit sets the freeze offset correction.

0 = Estimation of offset correction is not frozen (bit EN OFFSET CORR must be set)

1 = Estimation of offset correction is frozen (bit EN OFFSET CORR must be set). When frozen, the last estimated value is used for offset correction every clock cycle. See [OFFSET CORRECTION](#), *Offset Correction*.

Bit 6 Always write '0'

Bits[5:2] OFFSET CORR TIME CONSTANT

These bits set the offset correction time constant for the correction loop time constant in number of clock cycles.

VALUE	TIME CONSTANT (Number of Clock Cycles)
0000	1M
0001	2M
0010	4M
0011	8M
0100	16M
0101	32M
0110	64M
0111	128M
1000	256M
1001	512M
1010	1G
1011	2G

Bits[1:0] Always write '0'

Register Address DFh (Default = 00h)

7	6	5	4	3	2	1	0
0	0	LOW SPEED		0	0	0	0

Bits[7:1] Always write '0'

Bit 0 LOW SPEED: Low-speed mode

00, 01, 10 = Low-speed mode disabled (default state after reset); this setting is recommended for sampling rates greater than 80MSPS.

11 = Low-speed mode enabled; this setting is recommended for sampling rates less than or equal to 80MSPS.

TYPICAL CHARACTERISTICS: ADS4126

At +25°C, AVDD = 1.8V, DRVDD = 1.8V, maximum rated sampling frequency, sine wave input clock, 1.5V_{PP} differential clock amplitude, 50% clock duty cycle, -1dBFS differential analog input, 1dB gain, low-latency mode, DDR LVDS output interface, and 32k-point FFT, unless otherwise noted. Note that after reset, the device is in 0dB gain mode.

FFT FOR 10MHz INPUT SIGNAL

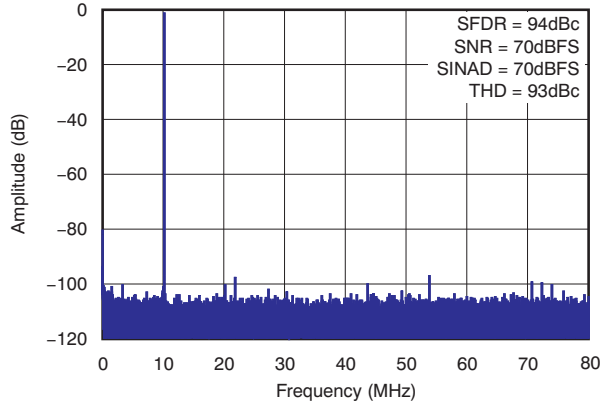

Figure 15.

FFT FOR 170MHz INPUT SIGNAL

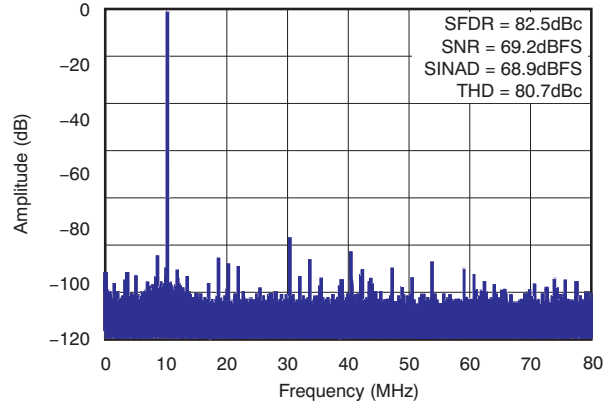

Figure 16.

FFT FOR 300MHz INPUT SIGNAL

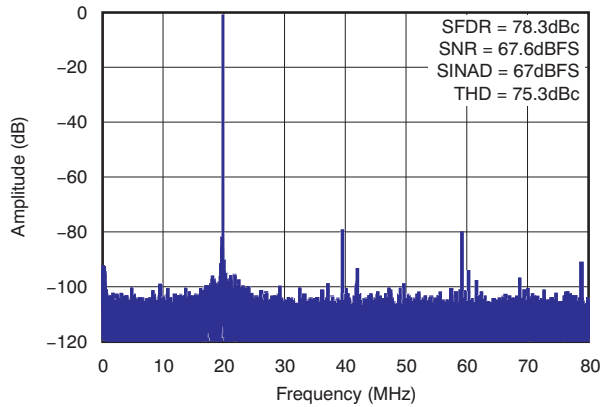

Figure 17.

FFT FOR TWO-TONE INPUT SIGNAL

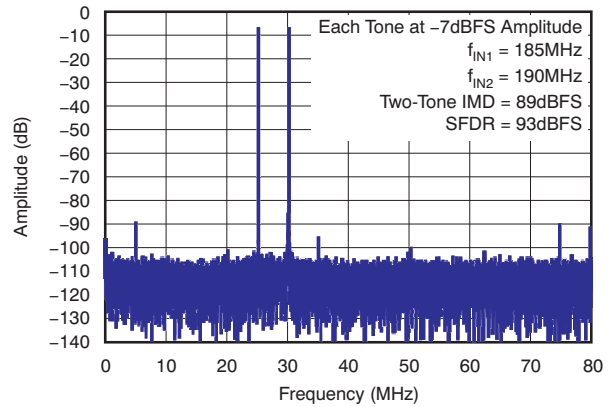

Figure 18.

SFDR vs INPUT FREQUENCY

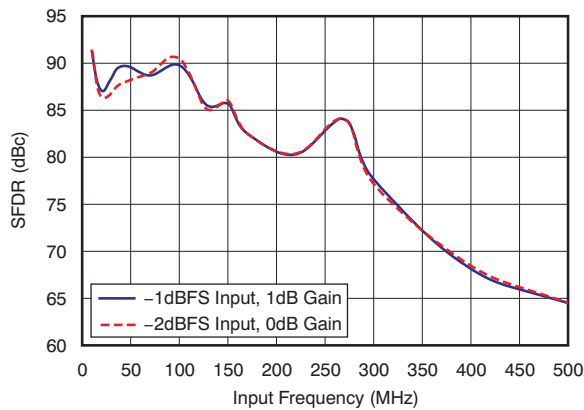

Figure 19.

SNR vs INPUT FREQUENCY

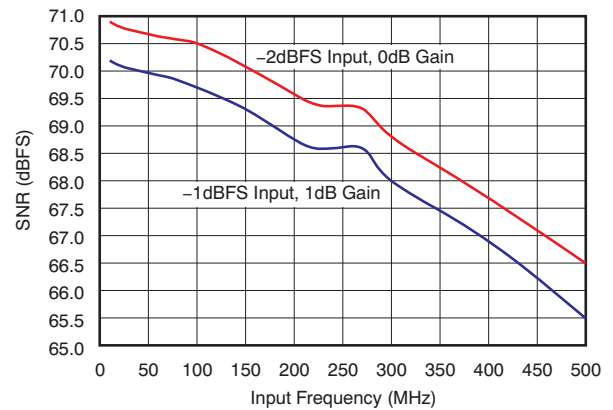

Figure 20.

TYPICAL CHARACTERISTICS: ADS4126 (continued)

At +25°C, AVDD = 1.8V, DRVDD = 1.8V, maximum rated sampling frequency, sine wave input clock, 1.5V_{PP} differential clock amplitude, 50% clock duty cycle, -1dBFS differential analog input, 1dB gain, low-latency mode, DDR LVDS output interface, and 32k-point FFT, unless otherwise noted. Note that after reset, the device is in 0dB gain mode.

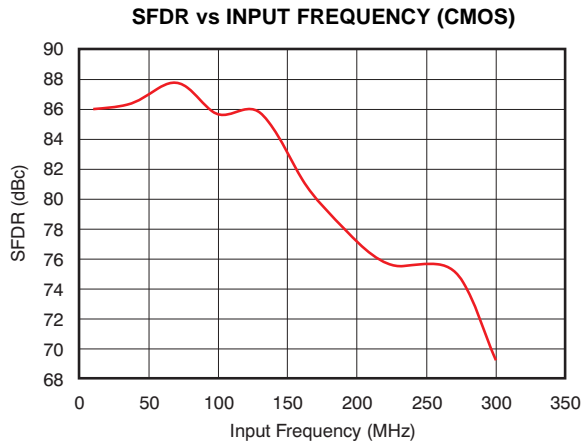

Figure 21.

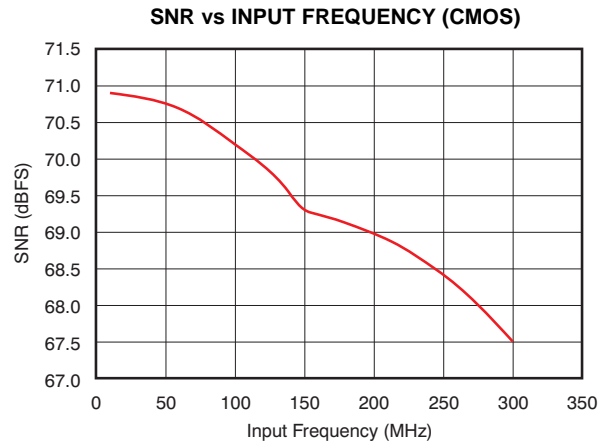

Figure 22.

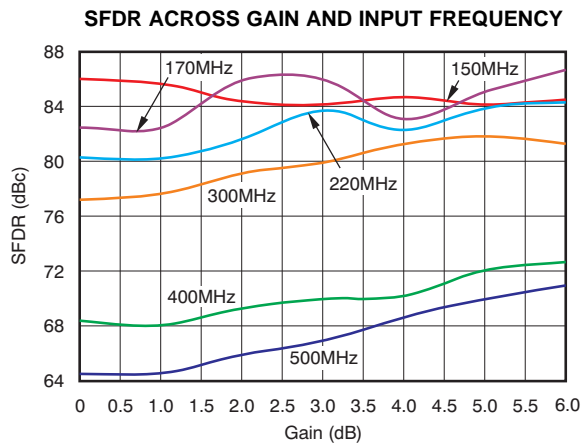

Figure 23.

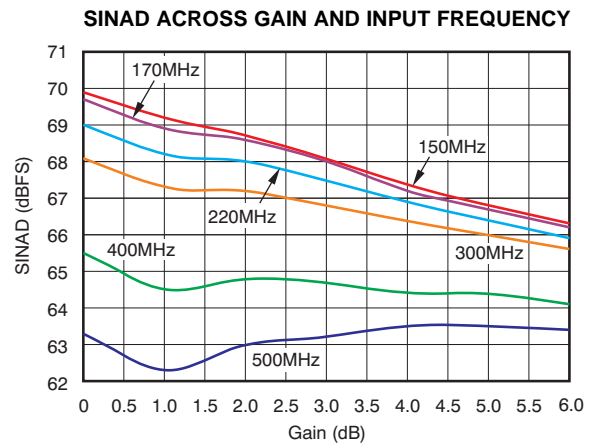

Figure 24.

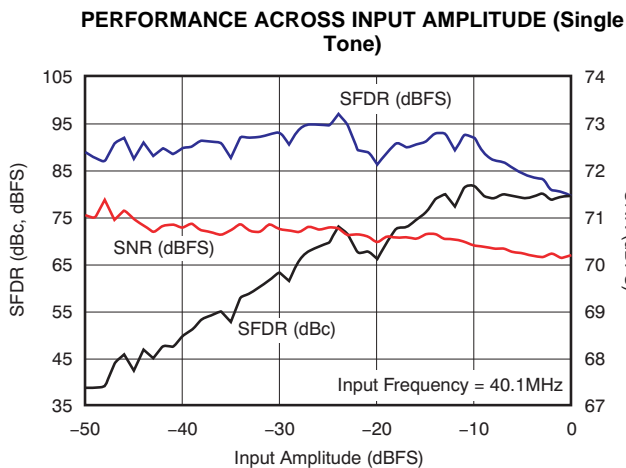

Figure 25.

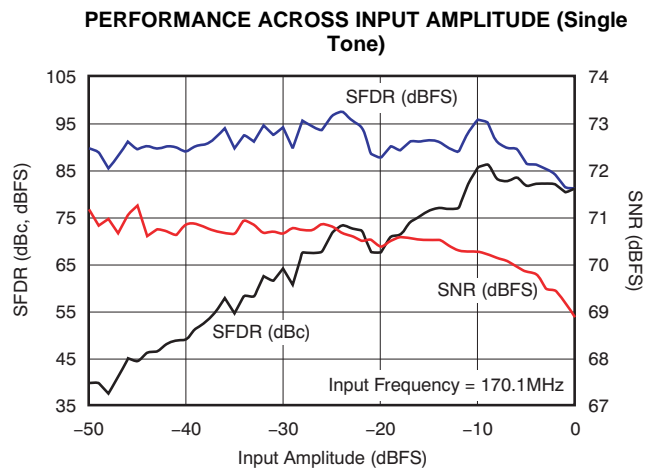

Figure 26.

TYPICAL CHARACTERISTICS: ADS4126 (continued)

At +25°C, AVDD = 1.8V, DRVDD = 1.8V, maximum rated sampling frequency, sine wave input clock, 1.5V_{pp} differential clock amplitude, 50% clock duty cycle, -1dBFS differential analog input, 1dB gain, low-latency mode, DDR LVDS output interface, and 32k-point FFT, unless otherwise noted. Note that after reset, the device is in 0dB gain mode.

PERFORMANCE vs INPUT COMMON-MODE VOLTAGE

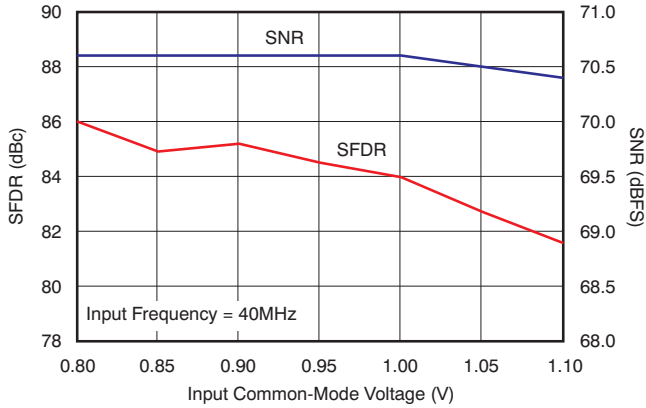

Figure 27.

SFDR ACROSS TEMPERATURE vs AVDD SUPPLY

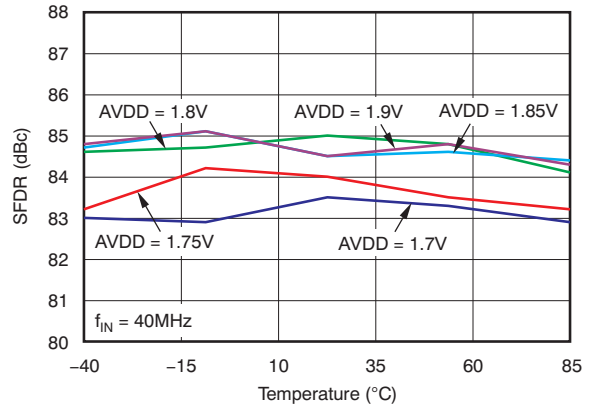

Figure 28.

SNR ACROSS TEMPERATURE vs AVDD SUPPLY

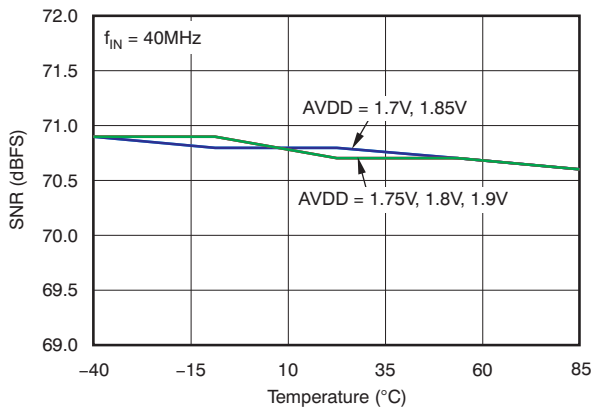

Figure 29.

PERFORMANCE ACROSS DRVDD SUPPLY VOLTAGE

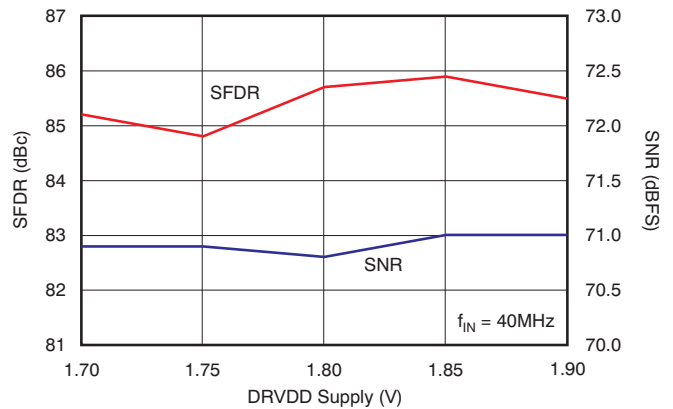

Figure 30.

PERFORMANCE ACROSS DRVDD SUPPLY VOLTAGE (CMOS)

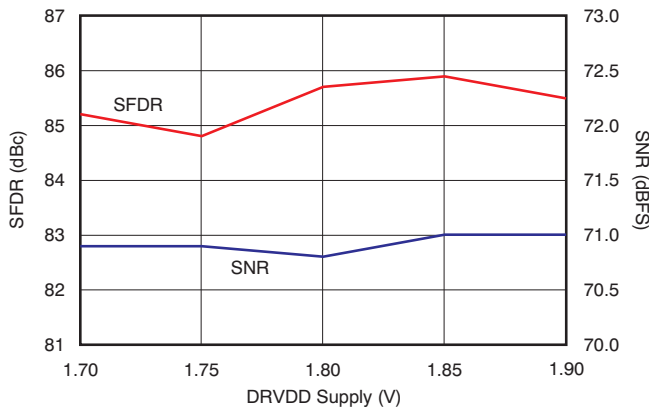

Figure 31.

PERFORMANCE ACROSS INPUT CLOCK AMPLITUDE

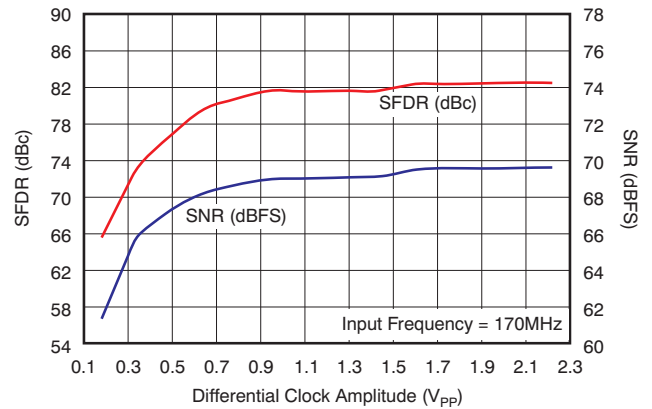

Figure 32.

TYPICAL CHARACTERISTICS: ADS4126 (continued)

At +25°C, AVDD = 1.8V, DRVDD = 1.8V, maximum rated sampling frequency, sine wave input clock, 1.5V_{PP} differential clock amplitude, 50% clock duty cycle, -1dBFS differential analog input, 1dB gain, low-latency mode, DDR LVDS output interface, and 32k-point FFT, unless otherwise noted. Note that after reset, the device is in 0dB gain mode.

PERFORMANCE ACROSS INPUT CLOCK DUTY CYCLE

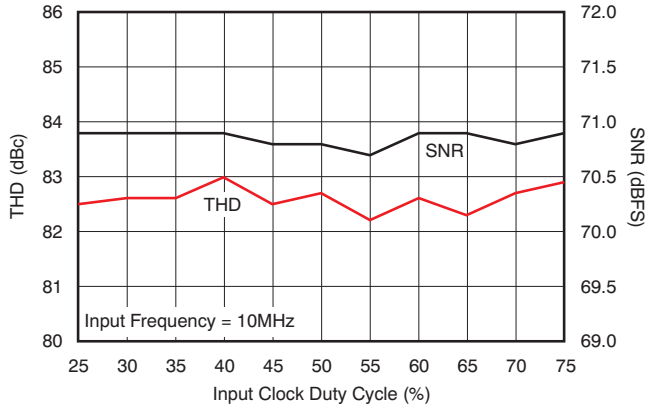

Figure 33.

INTEGRAL NONLINEARITY

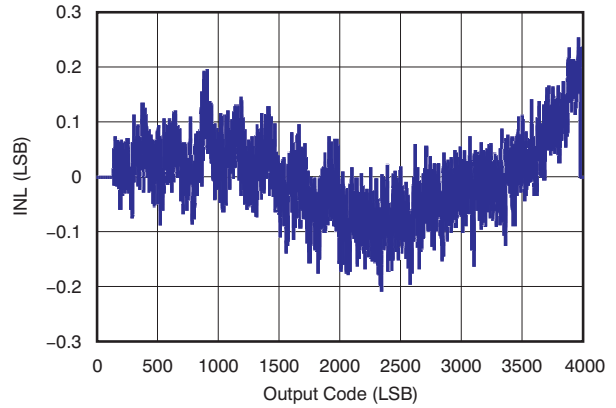

Figure 34.

DIFFERENTIAL NONLINEARITY

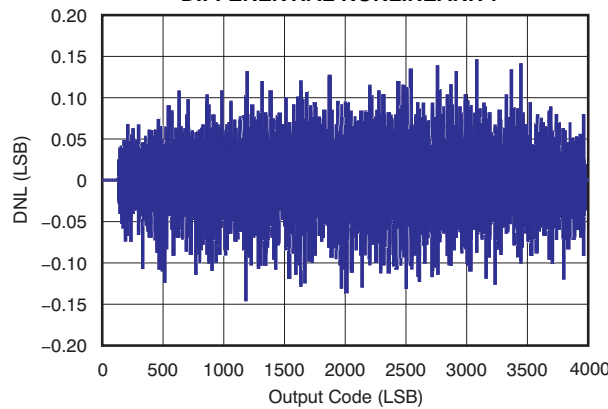

Figure 35.

TYPICAL CHARACTERISTICS: ADS4129

At +25°C, AVDD = 1.8V, DRVDD = 1.8V, maximum rated sampling frequency, sine wave input clock, 1.5V_{PP} differential clock amplitude, 50% clock duty cycle, -1dBFS differential analog input, 1dB gain, low-latency mode, DDR LVDS output interface, and 32k-point FFT, unless otherwise noted. Note that after reset, the device is in 0dB gain mode.

FFT FOR 10MHz INPUT SIGNAL

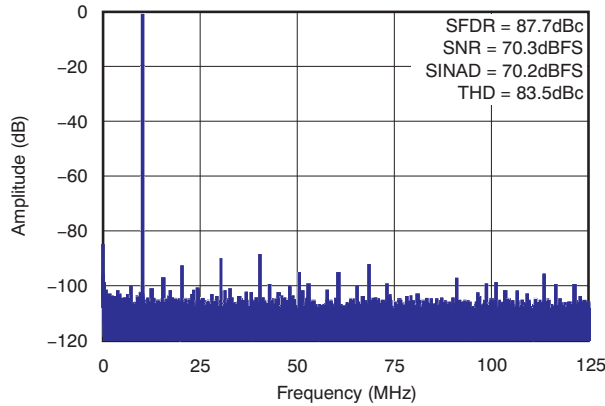

Figure 36.

FFT FOR 170MHz INPUT SIGNAL

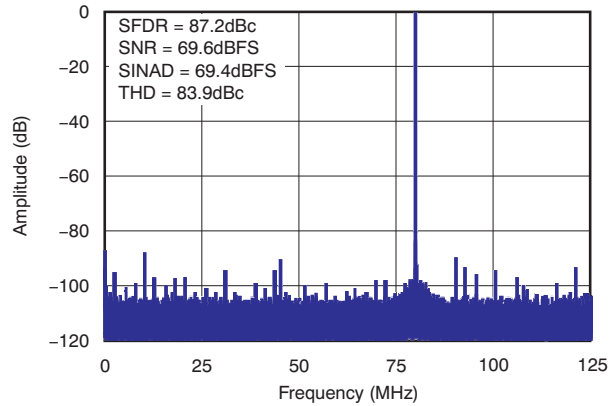

Figure 37.

FFT FOR 300MHz INPUT SIGNAL

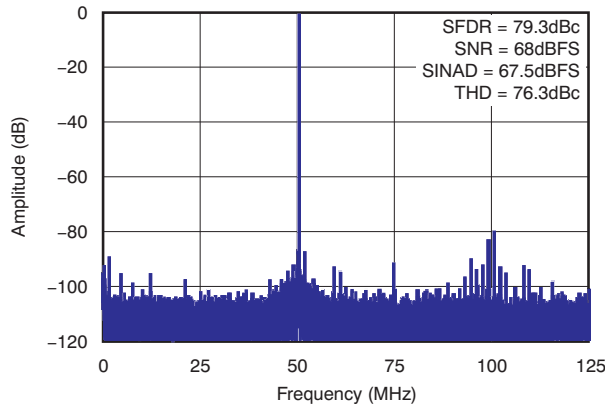

Figure 38.

FFT FOR TWO-TONE INPUT SIGNAL

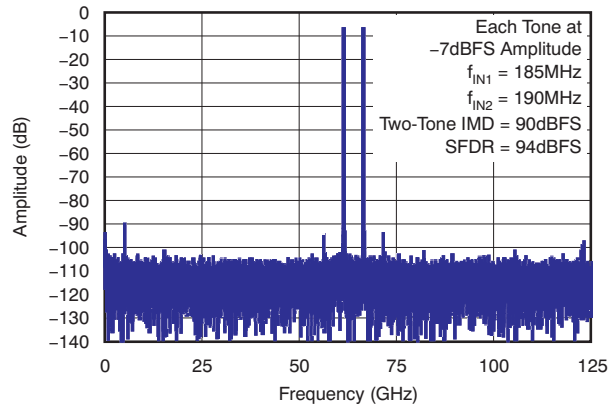

Figure 39.

SFDR vs INPUT FREQUENCY

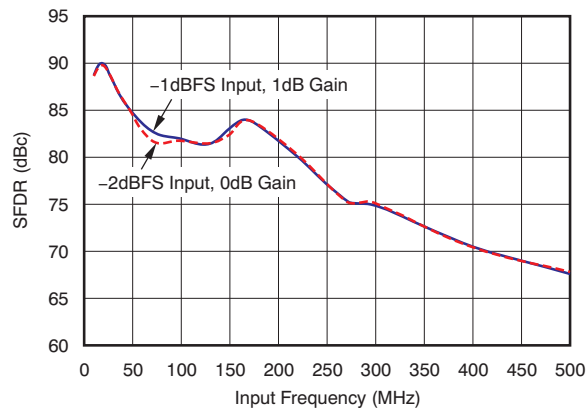

Figure 40.

SNR vs INPUT FREQUENCY

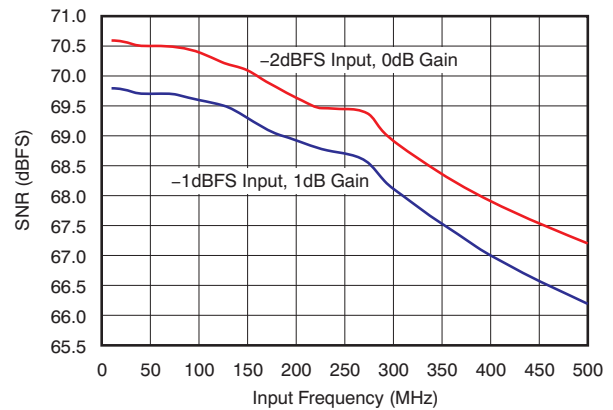

Figure 41.

TYPICAL CHARACTERISTICS: ADS4129 (continued)

At +25°C, AVDD = 1.8V, DRVDD = 1.8V, maximum rated sampling frequency, sine wave input clock, 1.5V_{PP} differential clock amplitude, 50% clock duty cycle, -1dBFS differential analog input, 1dB gain, low-latency mode, DDR LVDS output interface, and 32k-point FFT, unless otherwise noted. Note that after reset, the device is in 0dB gain mode.

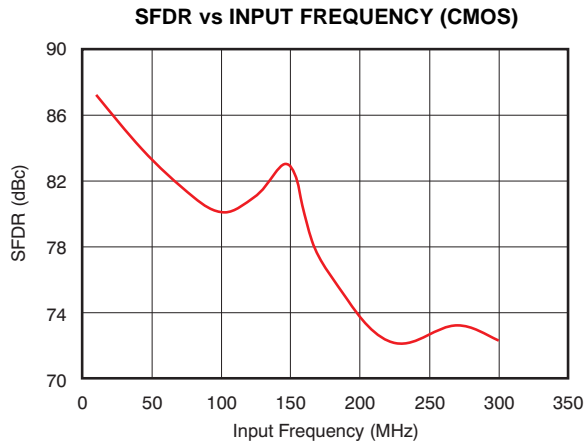

Figure 42.

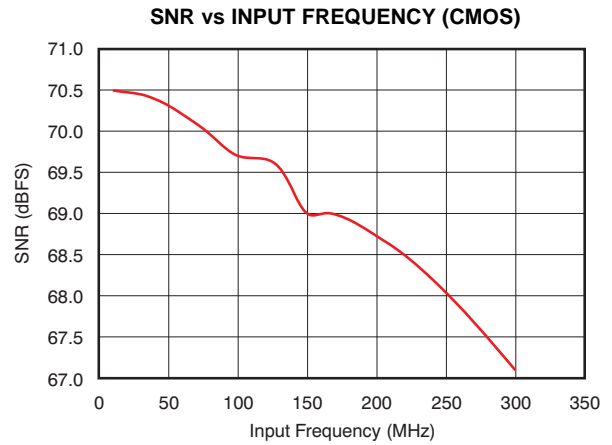

Figure 43.

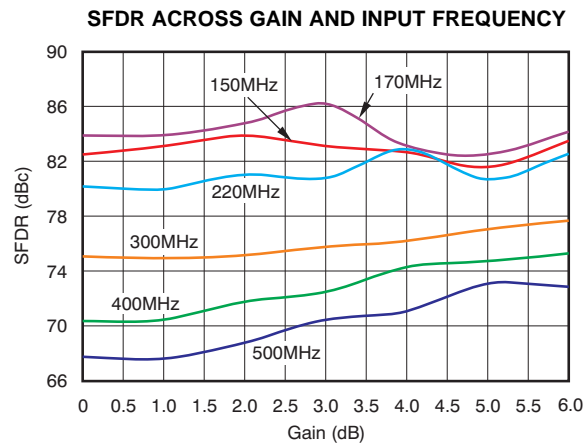

Figure 44.

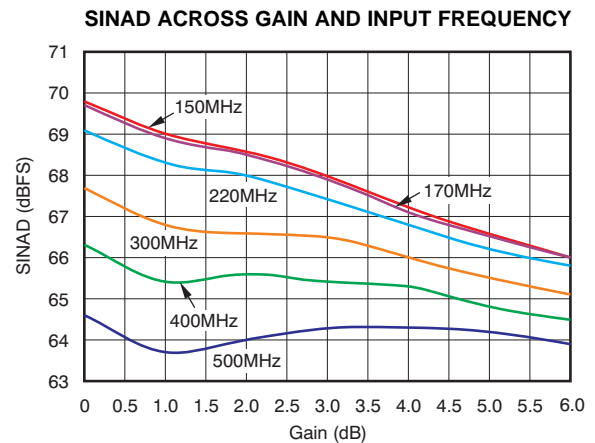

Figure 45.

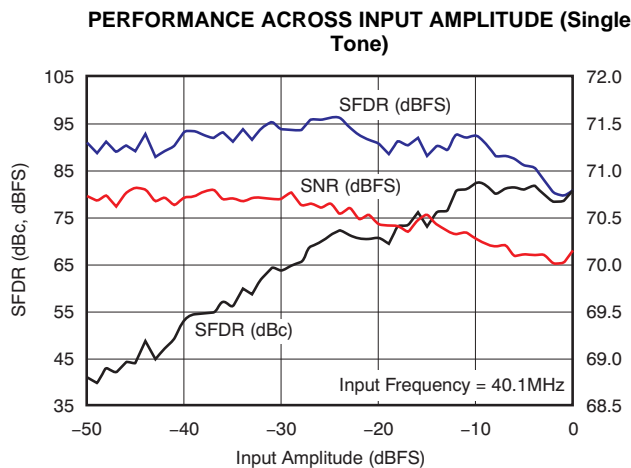

Figure 46.

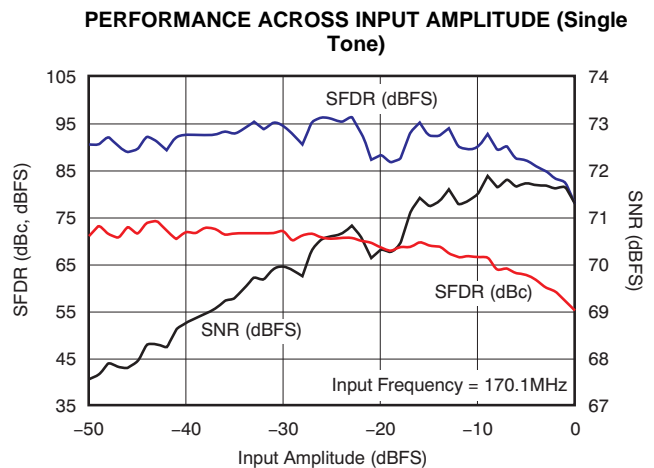

Figure 47.

TYPICAL CHARACTERISTICS: ADS4129 (continued)

At +25°C, AVDD = 1.8V, DRVDD = 1.8V, maximum rated sampling frequency, sine wave input clock, 1.5V_{PP} differential clock amplitude, 50% clock duty cycle, -1dBFS differential analog input, 1dB gain, low-latency mode, DDR LVDS output interface, and 32k-point FFT, unless otherwise noted. Note that after reset, the device is in 0dB gain mode.

PERFORMANCE vs INPUT COMMON-MODE VOLTAGE

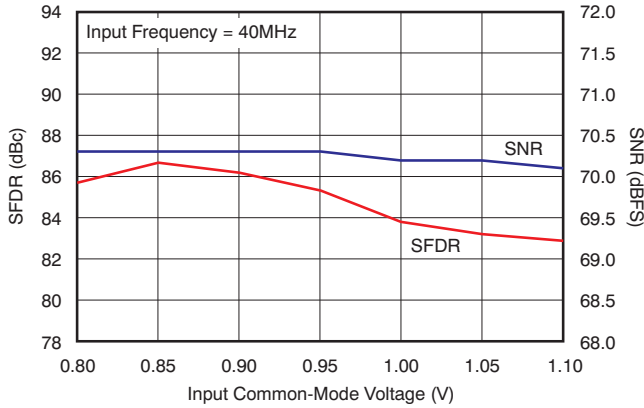

Figure 48.

SFDR ACROSS TEMPERATURE vs AVDD SUPPLY

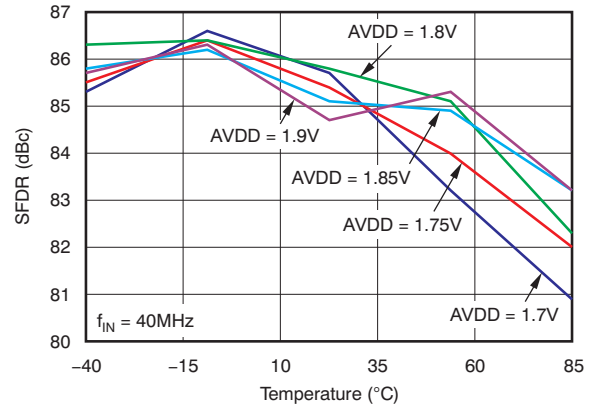

Figure 49.

SNR ACROSS TEMPERATURE vs AVDD SUPPLY

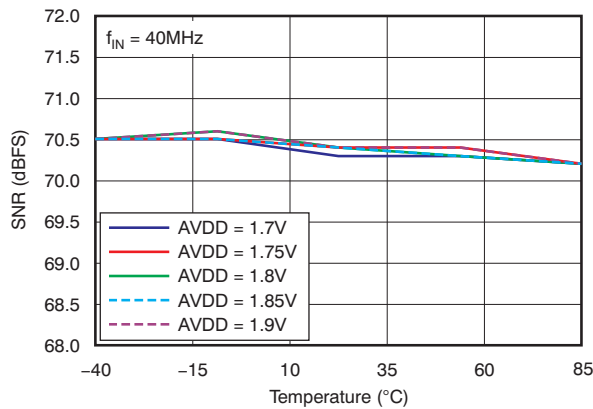

Figure 50.

PERFORMANCE ACROSS DRVDD SUPPLY VOLTAGE

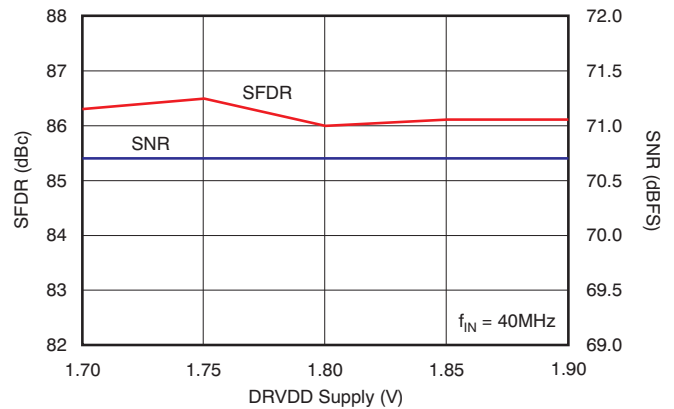

Figure 51.

PERFORMANCE ACROSS DRVDD SUPPLY VOLTAGE (CMOS)

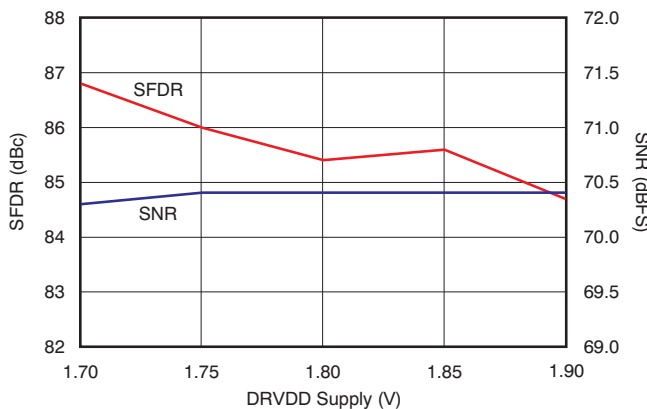

Figure 52.

PERFORMANCE ACROSS INPUT CLOCK AMPLITUDE

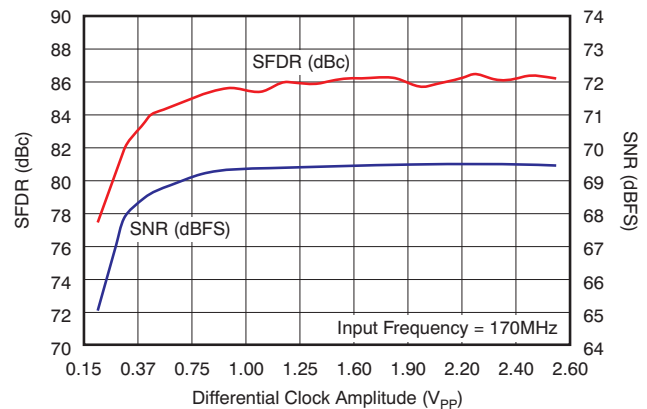

Figure 53.

TYPICAL CHARACTERISTICS: ADS4129 (continued)

At +25°C, AVDD = 1.8V, DRVDD = 1.8V, maximum rated sampling frequency, sine wave input clock, 1.5V_{PP} differential clock amplitude, 50% clock duty cycle, -1dBFS differential analog input, 1dB gain, low-latency mode, DDR LVDS output interface, and 32k-point FFT, unless otherwise noted. Note that after reset, the device is in 0dB gain mode.

PERFORMANCE ACROSS INPUT CLOCK DUTY CYCLE

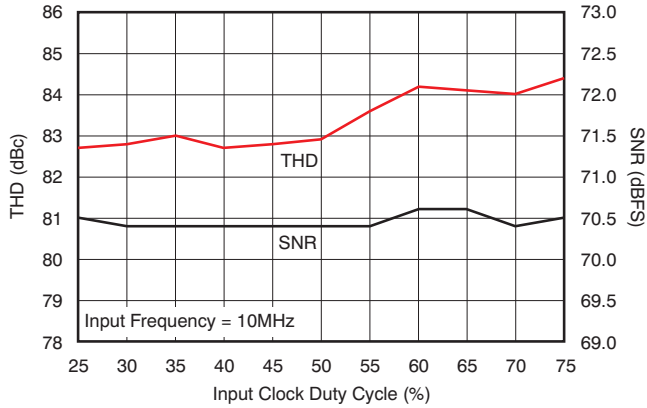

Figure 54.

INTEGRAL NONLINEARITY

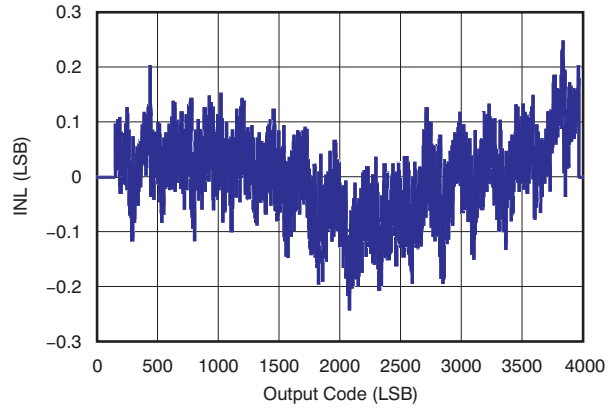

Figure 55.

DIFFERENTIAL NONLINEARITY

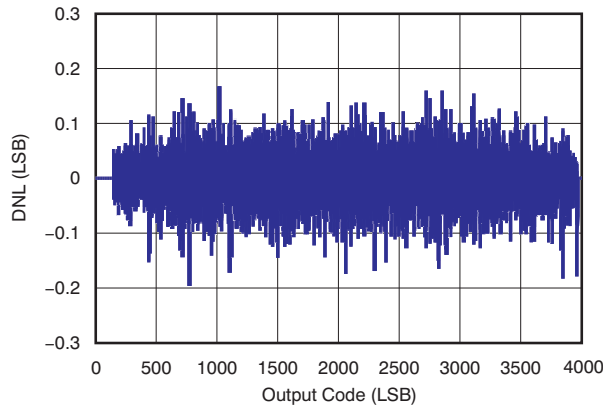

Figure 56.

TYPICAL CHARACTERISTICS: ADS4146

At +25°C, AVDD = 1.8V, DRVDD = 1.8V, maximum rated sampling frequency, sine wave input clock, 1.5V_{PP} differential clock amplitude, 50% clock duty cycle, -1dBFS differential analog input, 1dB gain, low-latency mode, DDR LVDS output interface, and 32k-point FFT, unless otherwise noted. Note that after reset, the device is in 0dB gain mode.

FFT FOR 10MHz INPUT SIGNAL

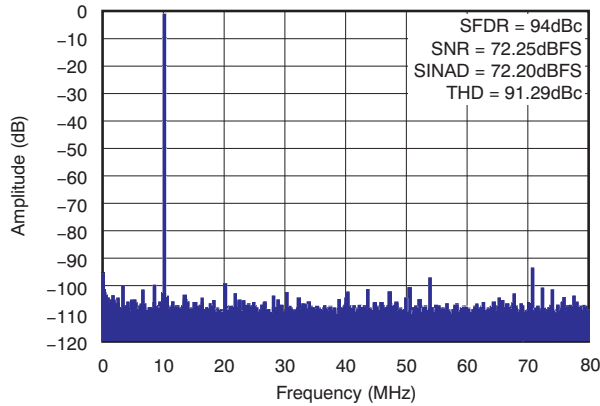

Figure 57.

FFT FOR 170MHz INPUT SIGNAL

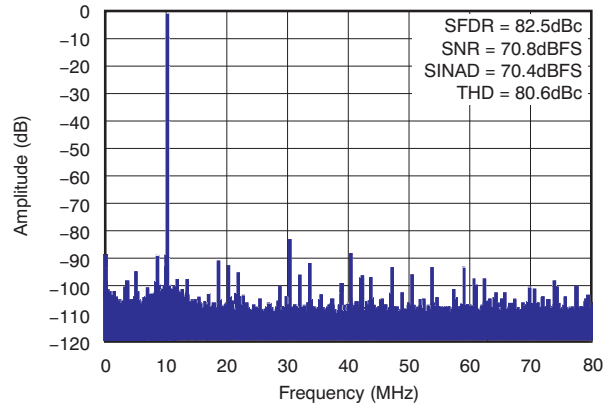

Figure 58.

FFT FOR 300MHz INPUT SIGNAL

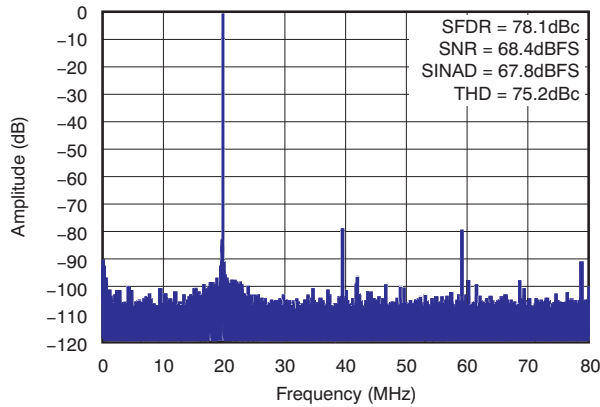

Figure 59.

FFT FOR TWO-TONE INPUT SIGNAL

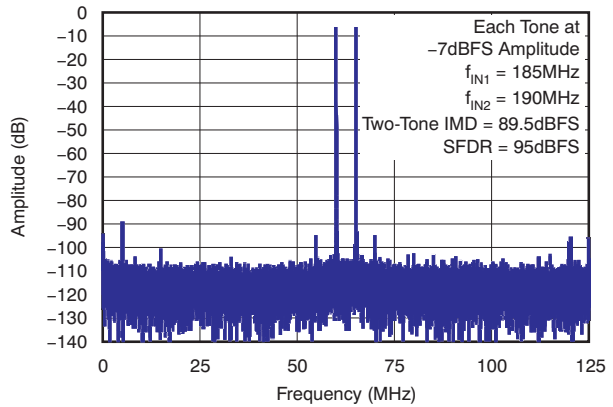

Figure 60.

SFDR vs INPUT FREQUENCY

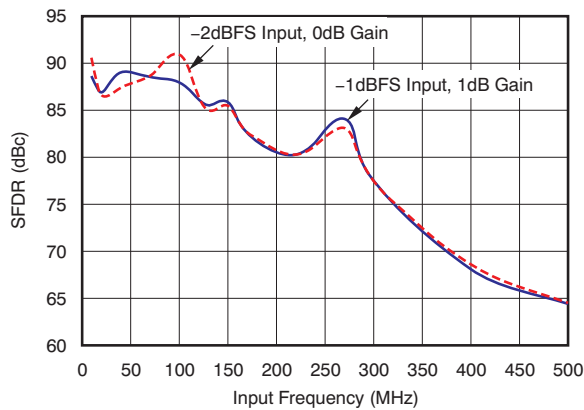

Figure 61.

SNR vs INPUT FREQUENCY

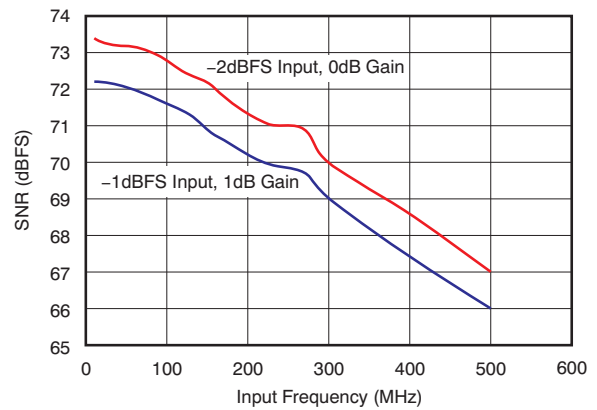

Figure 62.

TYPICAL CHARACTERISTICS: ADS4146 (continued)

At +25°C, AVDD = 1.8V, DRVDD = 1.8V, maximum rated sampling frequency, sine wave input clock, 1.5V_{PP} differential clock amplitude, 50% clock duty cycle, -1dBFS differential analog input, 1dB gain, low-latency mode, DDR LVDS output interface, and 32k-point FFT, unless otherwise noted. Note that after reset, the device is in 0dB gain mode.

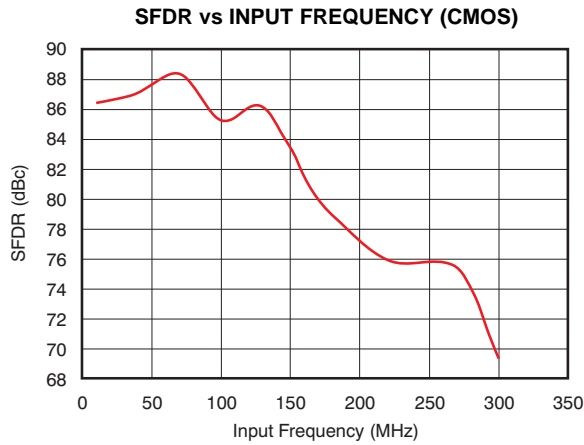

Figure 63.

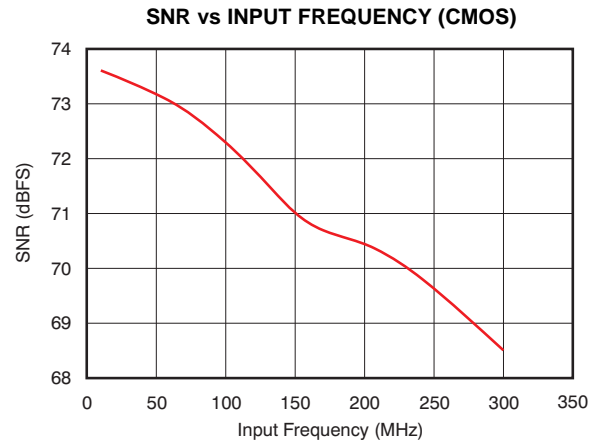

Figure 64.

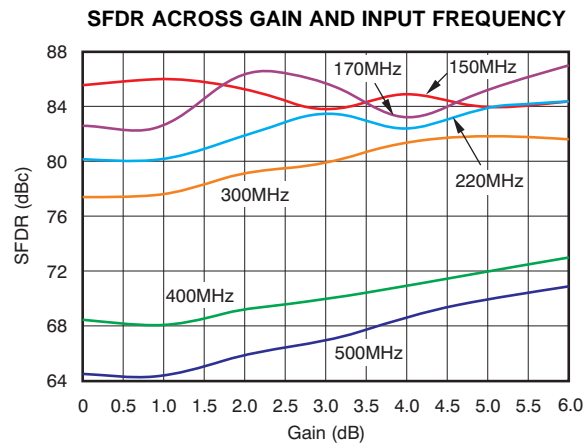

Figure 65.

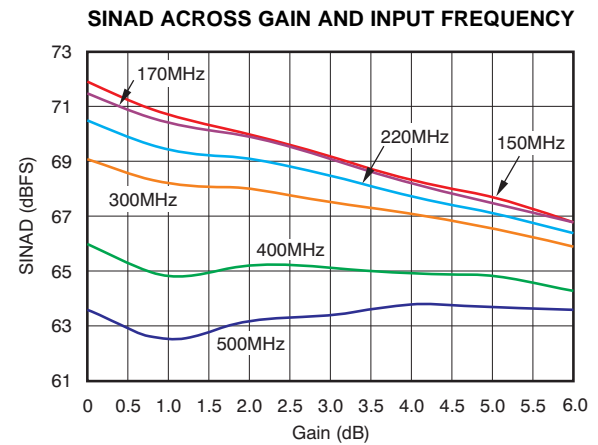

Figure 66.

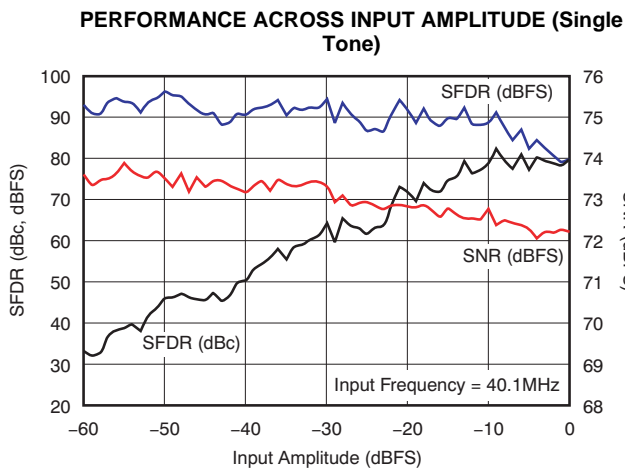

Figure 67.

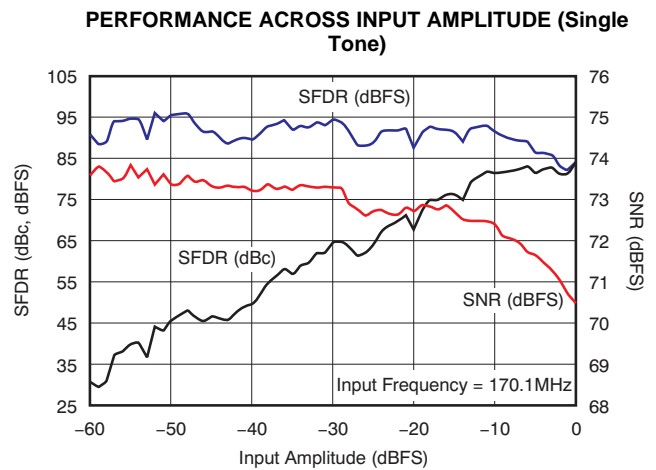

Figure 68.

TYPICAL CHARACTERISTICS: ADS4146 (continued)

At +25°C, AVDD = 1.8V, DRVDD = 1.8V, maximum rated sampling frequency, sine wave input clock, 1.5V_{PP} differential clock amplitude, 50% clock duty cycle, -1dBFS differential analog input, 1dB gain, low-latency mode, DDR LVDS output interface, and 32k-point FFT, unless otherwise noted. Note that after reset, the device is in 0dB gain mode.

PERFORMANCE vs INPUT COMMON-MODE VOLTAGE

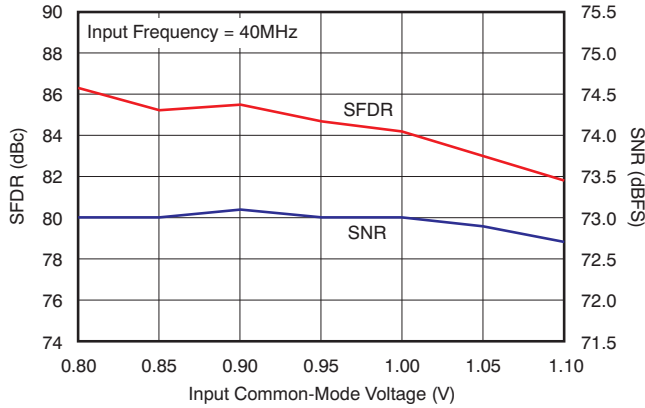

Figure 69.

SFDR ACROSS TEMPERATURE vs AVDD SUPPLY

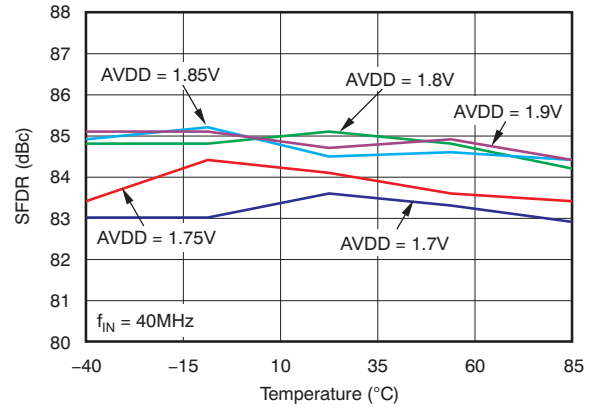

Figure 70.

SNR ACROSS TEMPERATURE vs AVDD SUPPLY

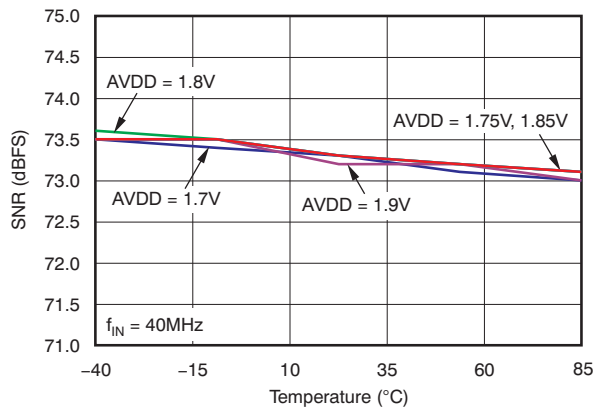

Figure 71.

PERFORMANCE ACROSS DRVDD SUPPLY VOLTAGE

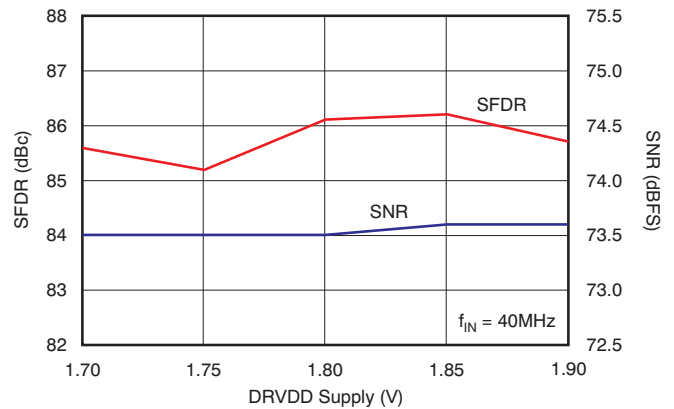

Figure 72.

PERFORMANCE ACROSS DRVDD SUPPLY VOLTAGE (CMOS)

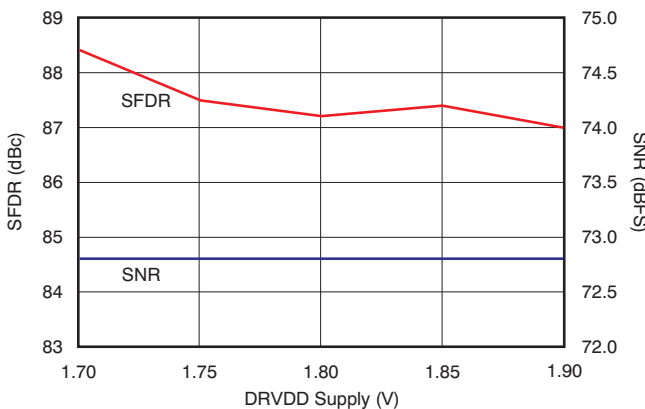

Figure 73.

PERFORMANCE ACROSS INPUT CLOCK AMPLITUDE

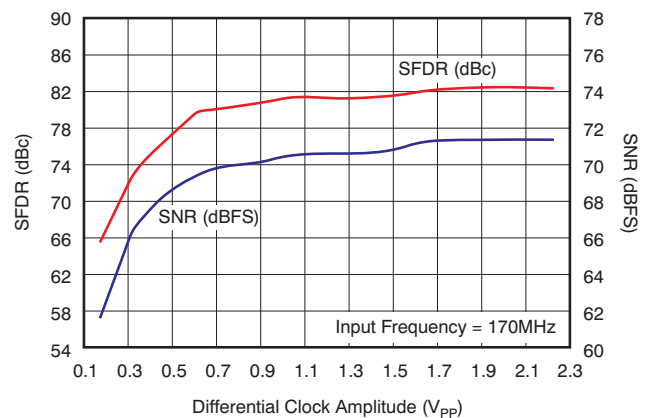

Figure 74.

TYPICAL CHARACTERISTICS: ADS4146 (continued)

At +25°C, AVDD = 1.8V, DRVDD = 1.8V, maximum rated sampling frequency, sine wave input clock, 1.5V_{pp} differential clock amplitude, 50% clock duty cycle, -1dBFS differential analog input, 1dB gain, low-latency mode, DDR LVDS output interface, and 32k-point FFT, unless otherwise noted. Note that after reset, the device is in 0dB gain mode.

PERFORMANCE ACROSS INPUT CLOCK DUTY CYCLE

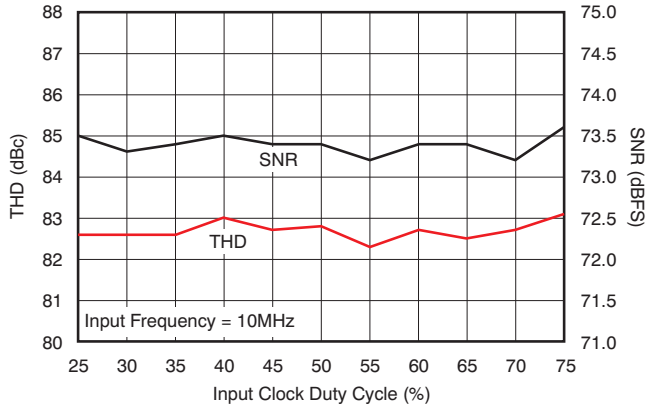

Figure 75.

INTEGRAL NONLINEARITY

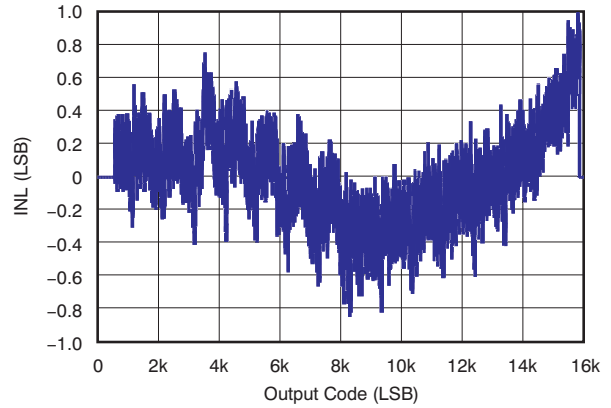

Figure 76.

DIFFERENTIAL NONLINEARITY

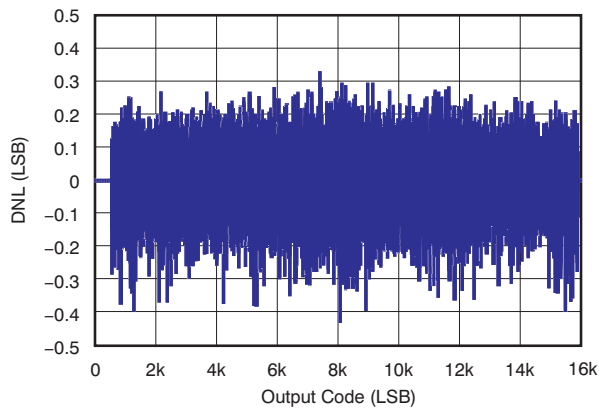

Figure 77.

OUTPUT HISTOGRAM WITH INPUTS SHORTED

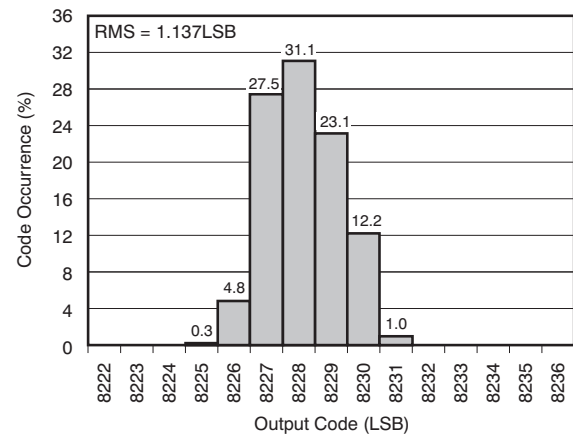

Figure 78.

TYPICAL CHARACTERISTICS: ADS4149

At +25°C, AVDD = 1.8V, DRVDD = 1.8V, maximum rated sampling frequency, sine wave input clock, 1.5V_{PP} differential clock amplitude, 50% clock duty cycle, -1dBFS differential analog input, 1dB gain, low-latency mode, DDR LVDS output interface, and 32k-point FFT, unless otherwise noted. Note that after reset, the device is in 0dB gain mode.

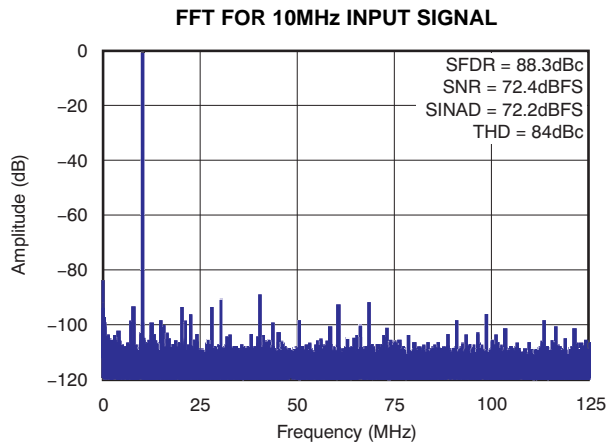

Figure 79.

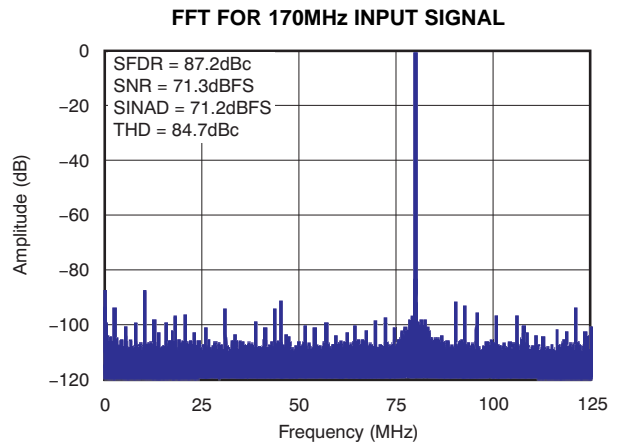

Figure 80.

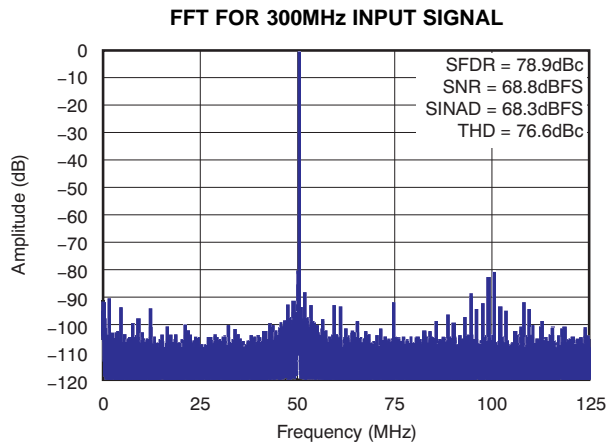

Figure 81.

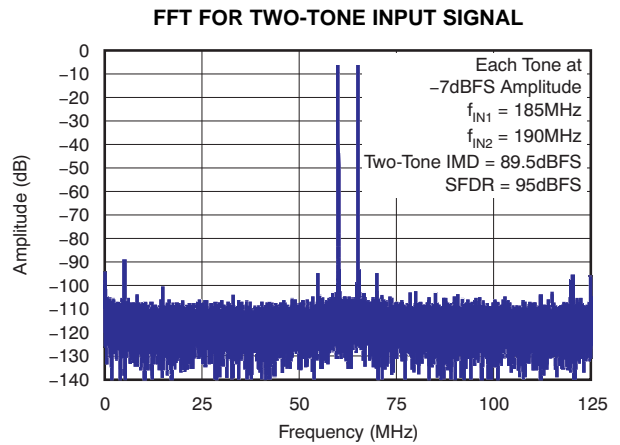

Figure 82.

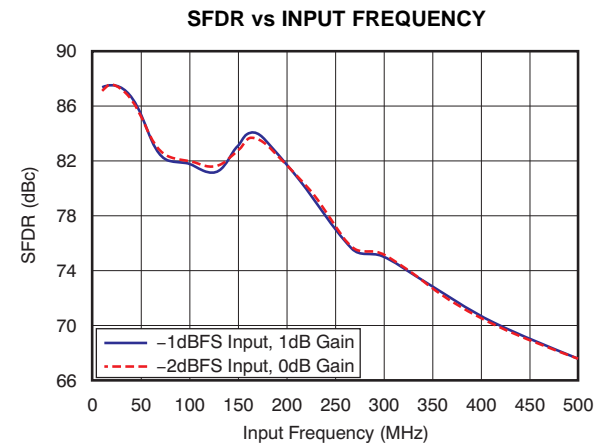

Figure 83.

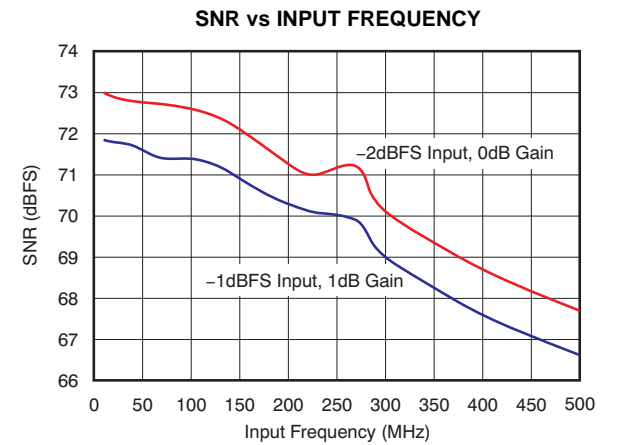

Figure 84.

TYPICAL CHARACTERISTICS: ADS4149 (continued)

At +25°C, AVDD = 1.8V, DRVDD = 1.8V, maximum rated sampling frequency, sine wave input clock, 1.5V_{pp} differential clock amplitude, 50% clock duty cycle, -1dBFS differential analog input, 1dB gain, low-latency mode, DDR LVDS output interface, and 32k-point FFT, unless otherwise noted. Note that after reset, the device is in 0dB gain mode.

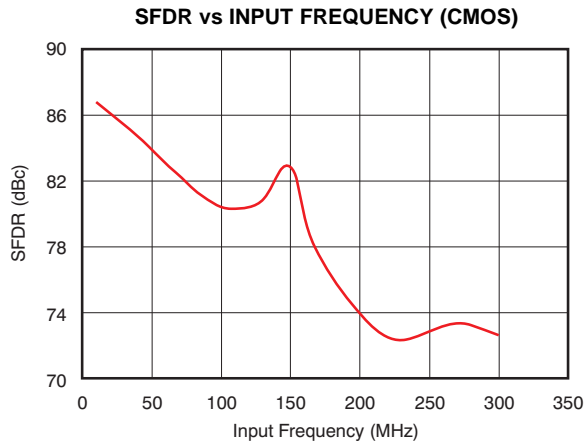

Figure 85.

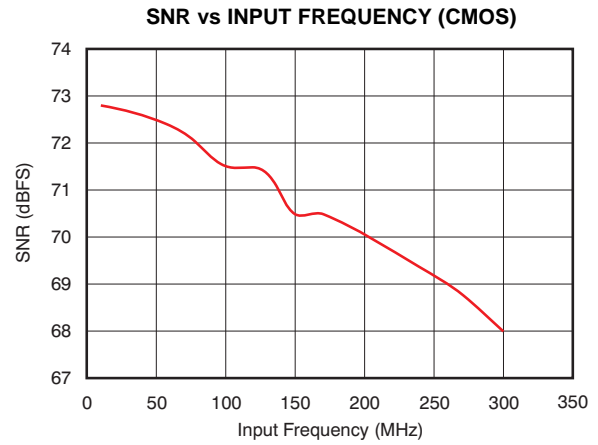

Figure 86.

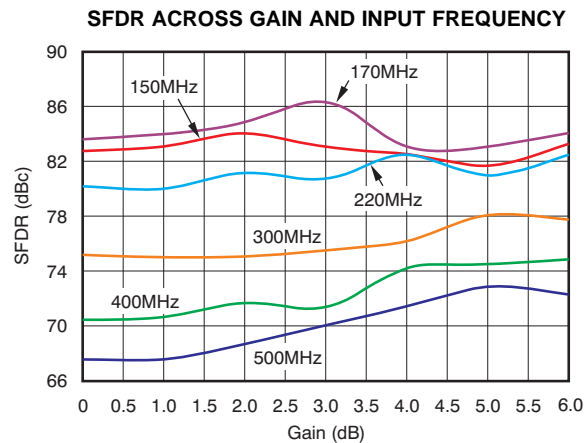

Figure 87.

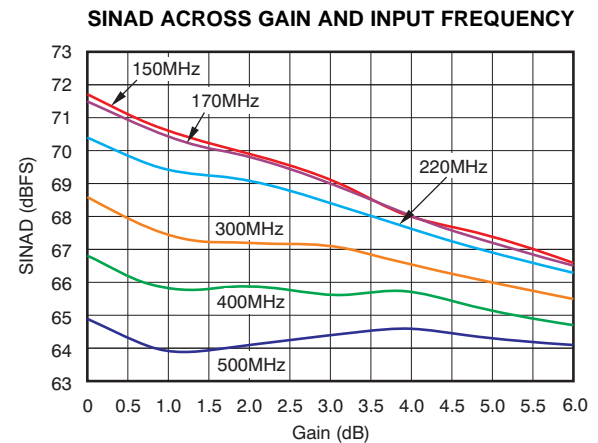

Figure 88.

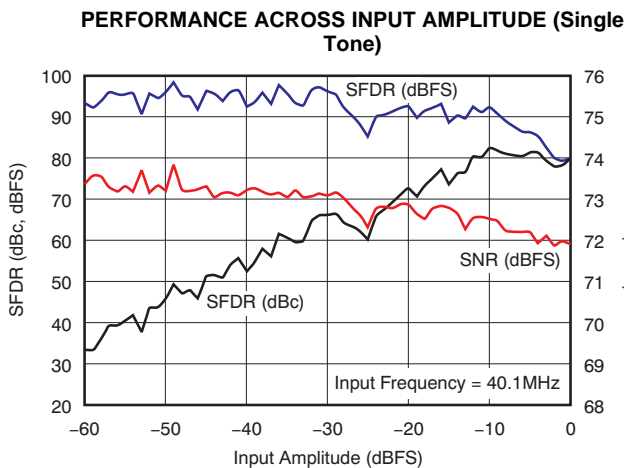

Figure 89.

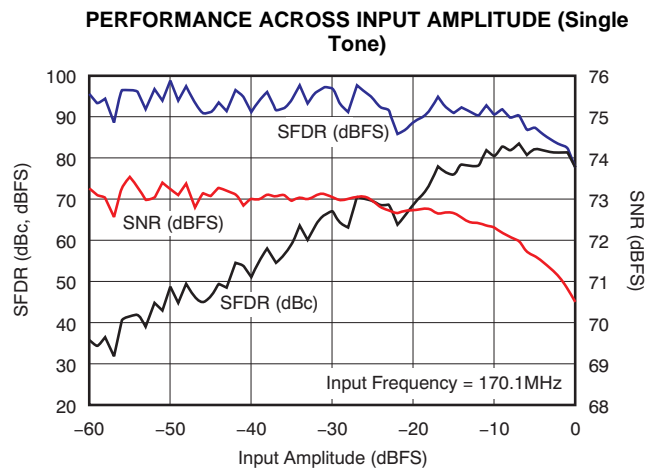

Figure 90.

TYPICAL CHARACTERISTICS: ADS4149 (continued)

At +25°C, AVDD = 1.8V, DRVDD = 1.8V, maximum rated sampling frequency, sine wave input clock, 1.5V_{pp} differential clock amplitude, 50% clock duty cycle, -1dBFS differential analog input, 1dB gain, low-latency mode, DDR LVDS output interface, and 32k-point FFT, unless otherwise noted. Note that after reset, the device is in 0dB gain mode.

PERFORMANCE vs INPUT COMMON-MODE VOLTAGE

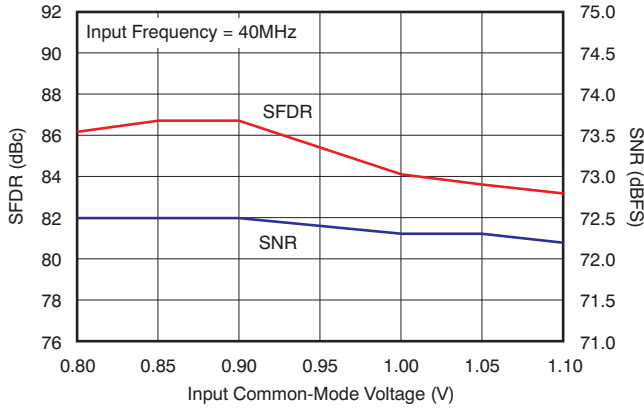

Figure 91.

SFDR ACROSS TEMPERATURE vs AVDD SUPPLY

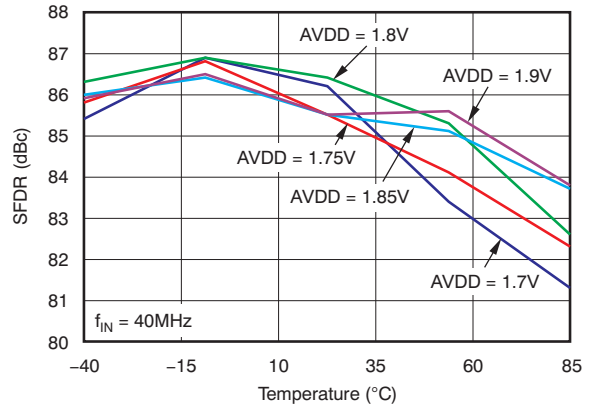

Figure 92.

SNR ACROSS TEMPERATURE vs AVDD SUPPLY

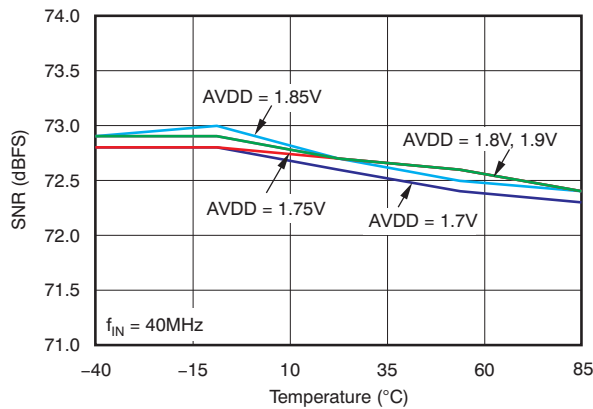

Figure 93.

PERFORMANCE ACROSS DRVDD SUPPLY VOLTAGE

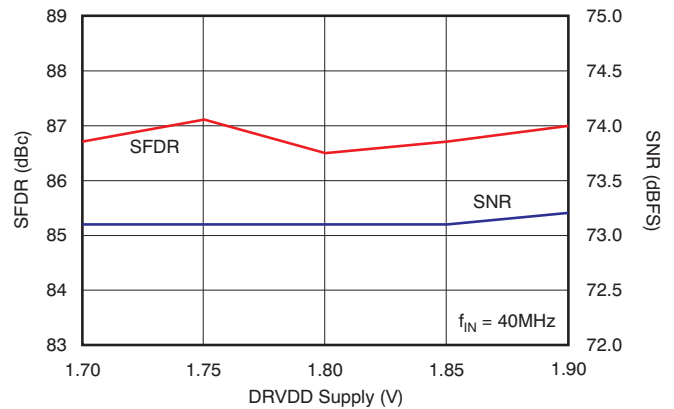

Figure 94.

PERFORMANCE ACROSS DRVDD SUPPLY VOLTAGE (CMOS)

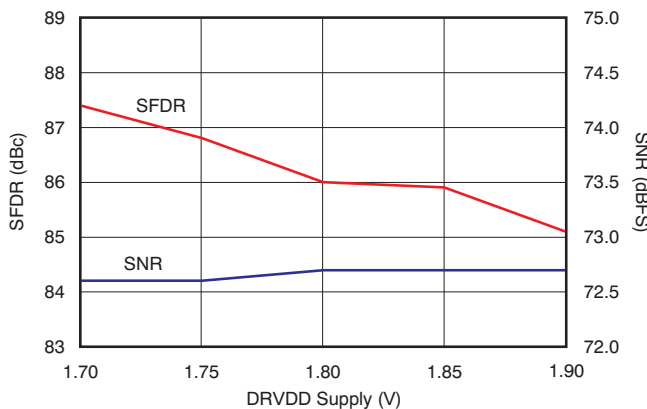

Figure 95.

PERFORMANCE ACROSS INPUT CLOCK AMPLITUDE

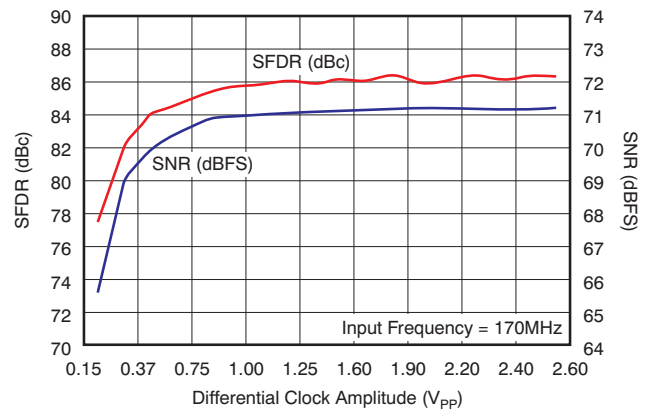

Figure 96.

TYPICAL CHARACTERISTICS: ADS4149 (continued)

At +25°C, AVDD = 1.8V, DRVDD = 1.8V, maximum rated sampling frequency, sine wave input clock, 1.5V_{PP} differential clock amplitude, 50% clock duty cycle, -1dBFS differential analog input, 1dB gain, low-latency mode, DDR LVDS output interface, and 32k-point FFT, unless otherwise noted. Note that after reset, the device is in 0dB gain mode.

PERFORMANCE ACROSS INPUT CLOCK DUTY CYCLE

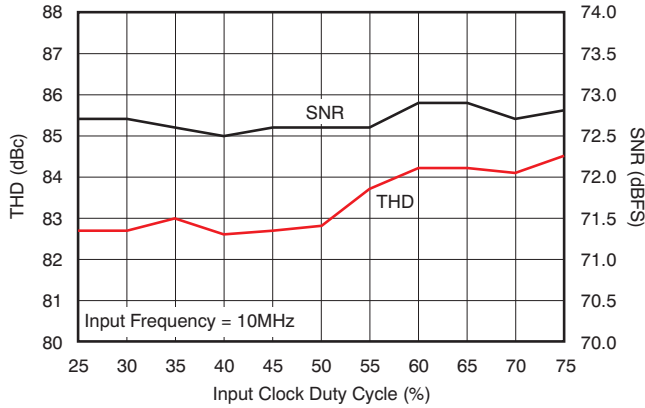

Figure 97.

INTEGRAL NONLINEARITY

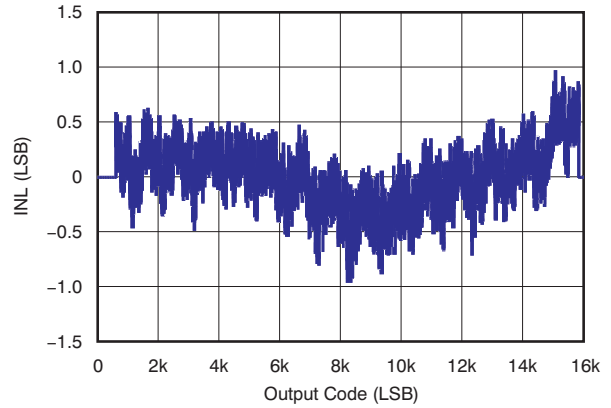

Figure 98.

DIFFERENTIAL NONLINEARITY

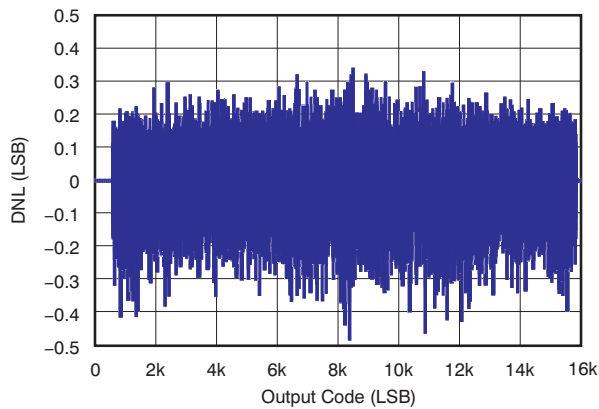

Figure 99.

OUTPUT HISTOGRAM WITH INPUTS SHORTED

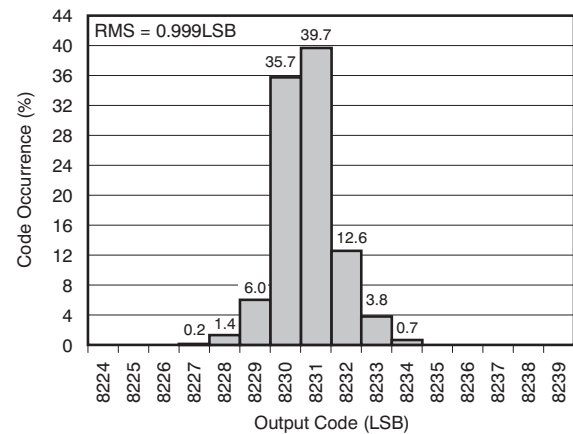

Figure 100.

TYPICAL CHARACTERISTICS: COMMON

At +25°C, AVDD = 1.8V, DRVDD = 1.8V, maximum rated sampling frequency, sine wave input clock, 1.5V_{PP} differential clock amplitude, 50% clock duty cycle, -1dBFS differential analog input, 1dB gain, low-latency mode, DDR LVDS output interface, and 32k-point FFT, unless otherwise noted. Note that after reset, the device is in 0dB gain mode.

CMRR ACROSS FREQUENCY

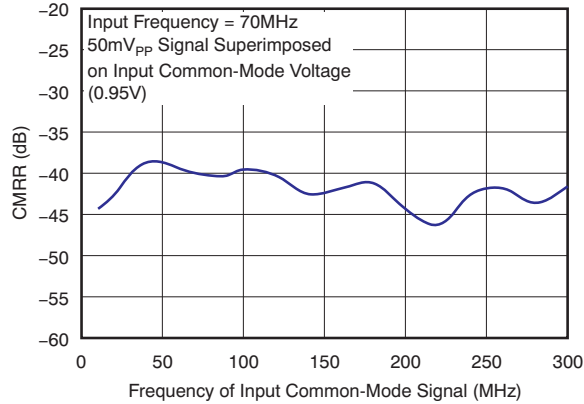

Figure 101.

CMRR SPECTRUM

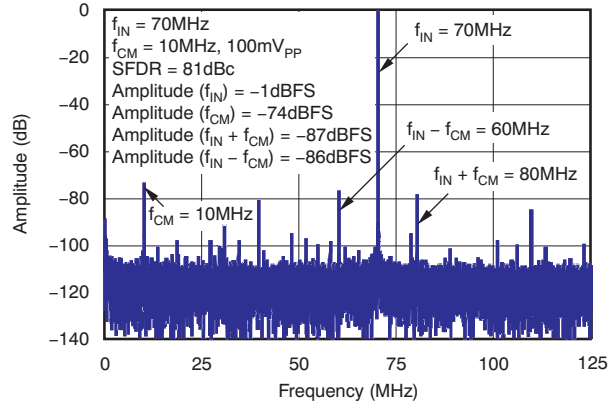

Figure 102.

PSRR ACROSS FREQUENCY

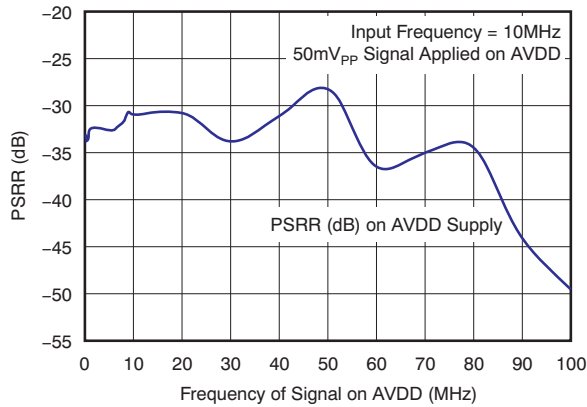

Figure 103.

ZOOMED VIEW OF SPECTRUM WITH PSRR SIGNAL

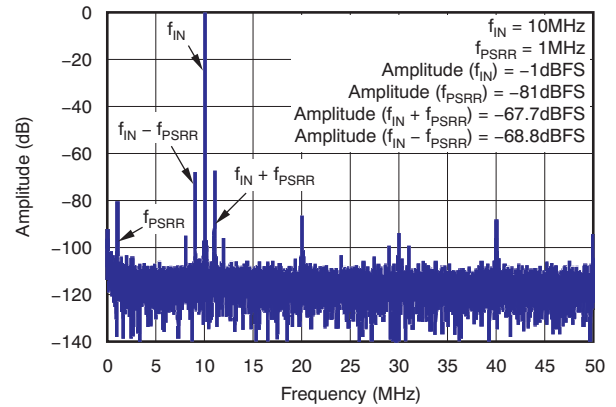

Figure 104.

POWER ACROSS SAMPLING FREQUENCY

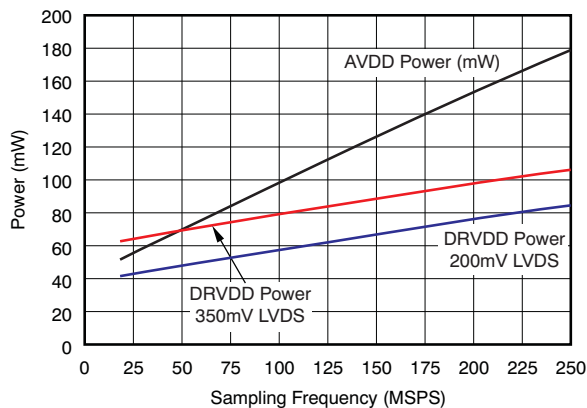

Figure 105.

DRVDD CURRENT ACROSS SAMPLING FREQUENCY

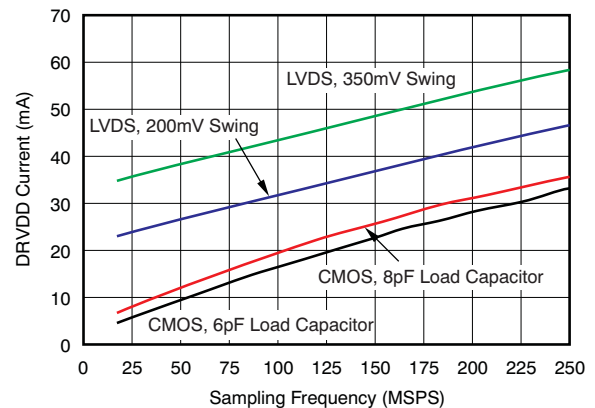

Figure 106.

TYPICAL CHARACTERISTICS: CONTOUR

At +25°C, AVDD = 1.8V, DRVDD = 1.8V, maximum rated sampling frequency, sine wave input clock, 1.5V_{PP} differential clock amplitude, 50% clock duty cycle, -1dBFS differential analog input, 1dB gain, low-latency mode, DDR LVDS output interface, and 32k-point FFT, unless otherwise noted. Note that after reset, the device is in 0dB gain mode.

SFDR ACROSS INPUT AND SAMPLING FREQUENCIES (1dB Gain)
Applies to ADS412x and ADS414x

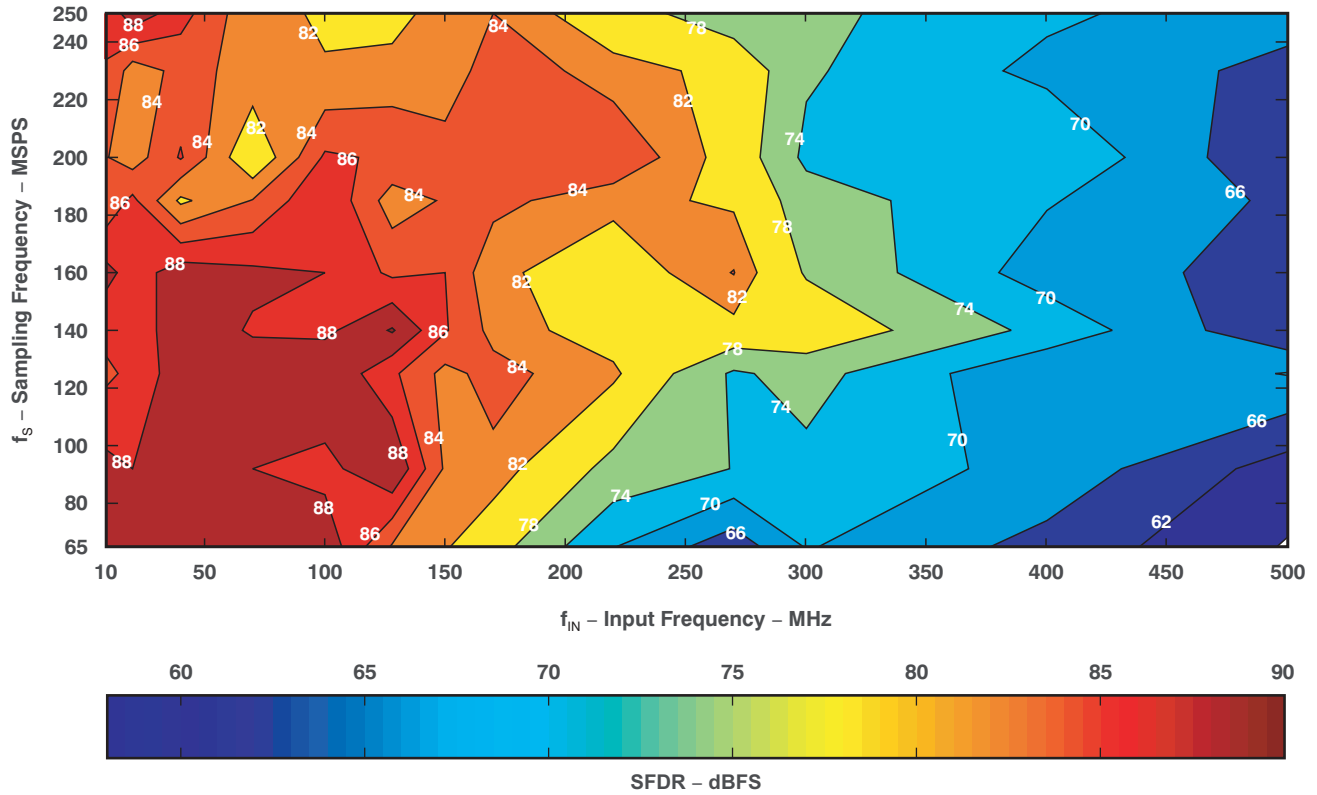

Figure 107.

TYPICAL CHARACTERISTICS: CONTOUR (continued)

At +25°C, AVDD = 1.8V, DRVDD = 1.8V, maximum rated sampling frequency, sine wave input clock, 1.5V_{pp} differential clock amplitude, 50% clock duty cycle, -1dBFS differential analog input, 1dB gain, low-latency mode, DDR LVDS output interface, and 32k-point FFT, unless otherwise noted. Note that after reset, the device is in 0dB gain mode.

SFDR ACROSS INPUT AND SAMPLING FREQUENCIES (6dB Gain)

Applies to ADS412x and ADS414x

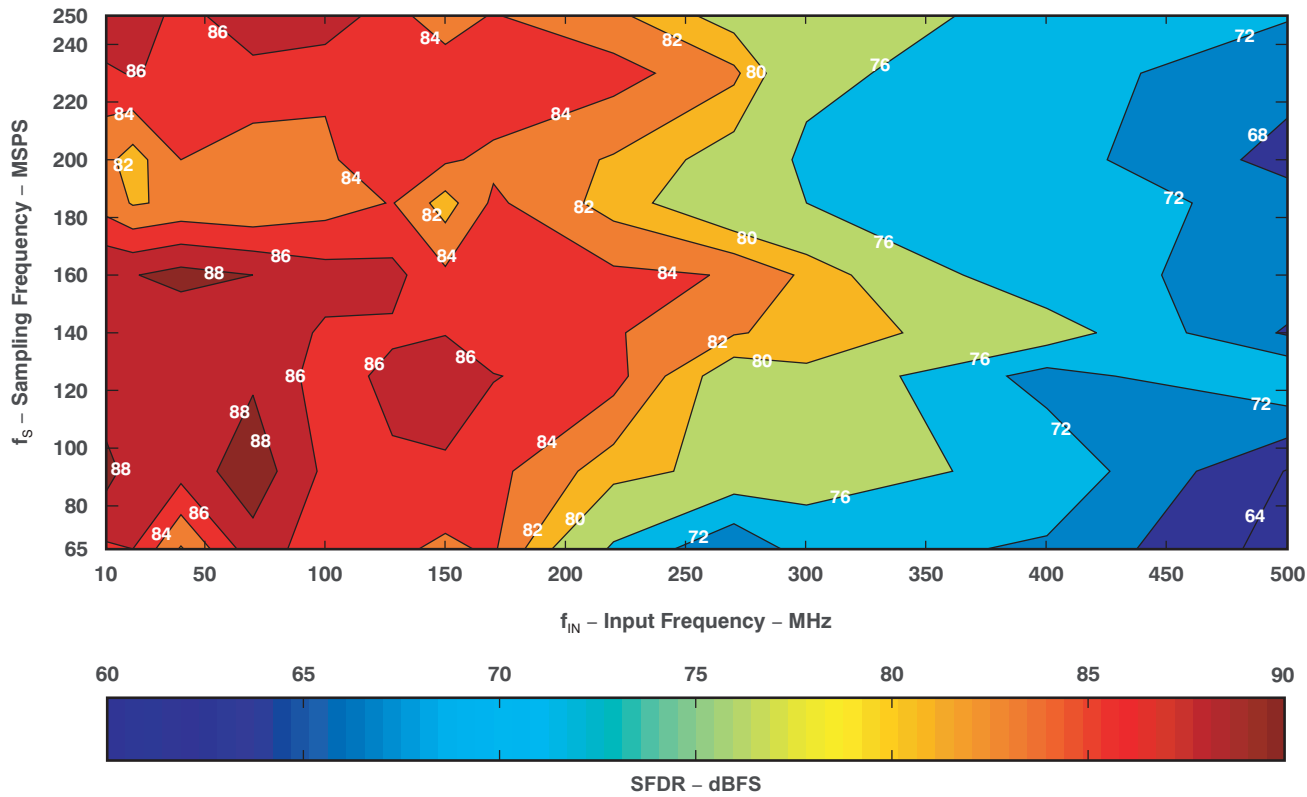

Figure 108.

TYPICAL CHARACTERISTICS: CONTOUR (continued)

At +25°C, AVDD = 1.8V, DRVDD = 1.8V, maximum rated sampling frequency, sine wave input clock, 1.5V_{PP} differential clock amplitude, 50% clock duty cycle, -1dBFS differential analog input, 1dB gain, low-latency mode, DDR LVDS output interface, and 32k-point FFT, unless otherwise noted. Note that after reset, the device is in 0dB gain mode.

**ADS412x SNR ACROSS INPUT AND SAMPLING FREQUENCIES
 (1dB Gain)**

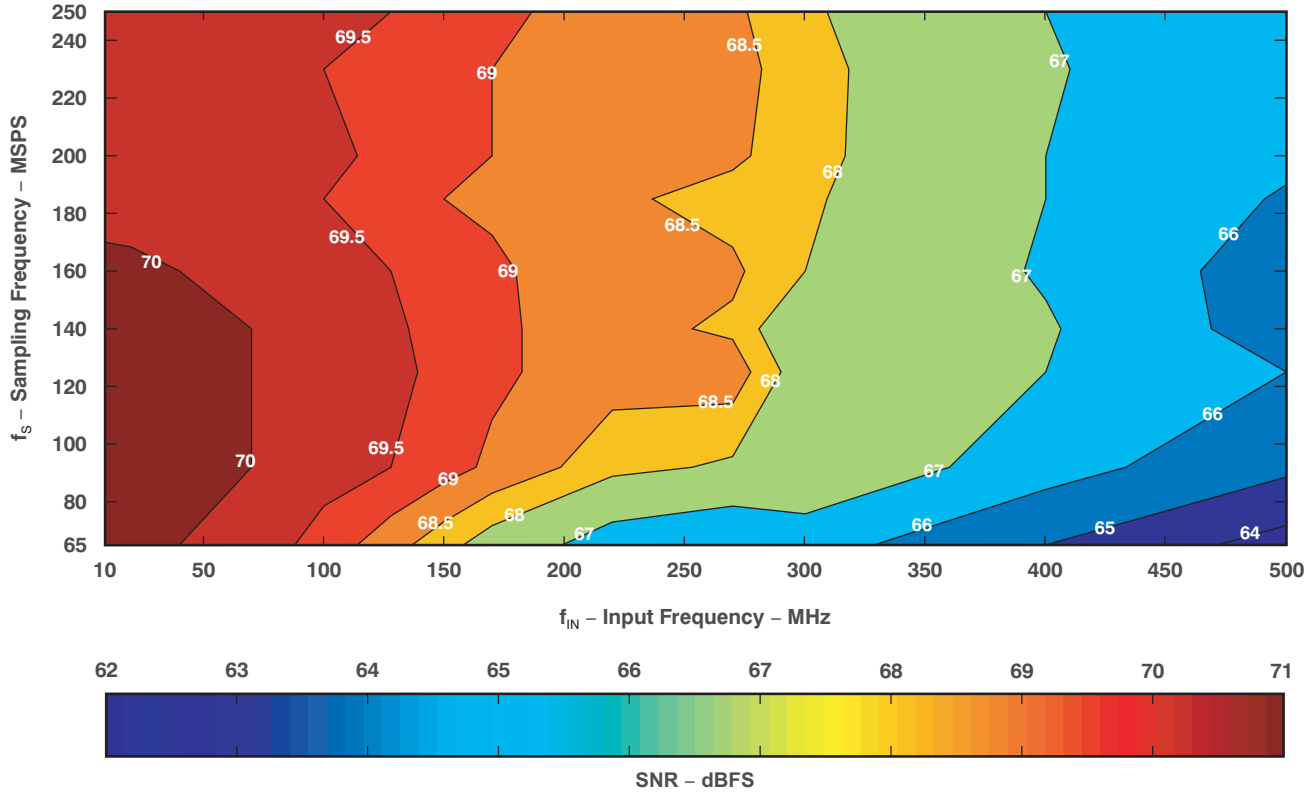

Figure 109.

TYPICAL CHARACTERISTICS: CONTOUR (continued)

At +25°C, AVDD = 1.8V, DRVDD = 1.8V, maximum rated sampling frequency, sine wave input clock, 1.5V_{pp} differential clock amplitude, 50% clock duty cycle, -1dBFS differential analog input, 1dB gain, low-latency mode, DDR LVDS output interface, and 32k-point FFT, unless otherwise noted. Note that after reset, the device is in 0dB gain mode.

**ADS412x SNR ACROSS INPUT AND SAMPLING FREQUENCIES
(6dB Gain)**

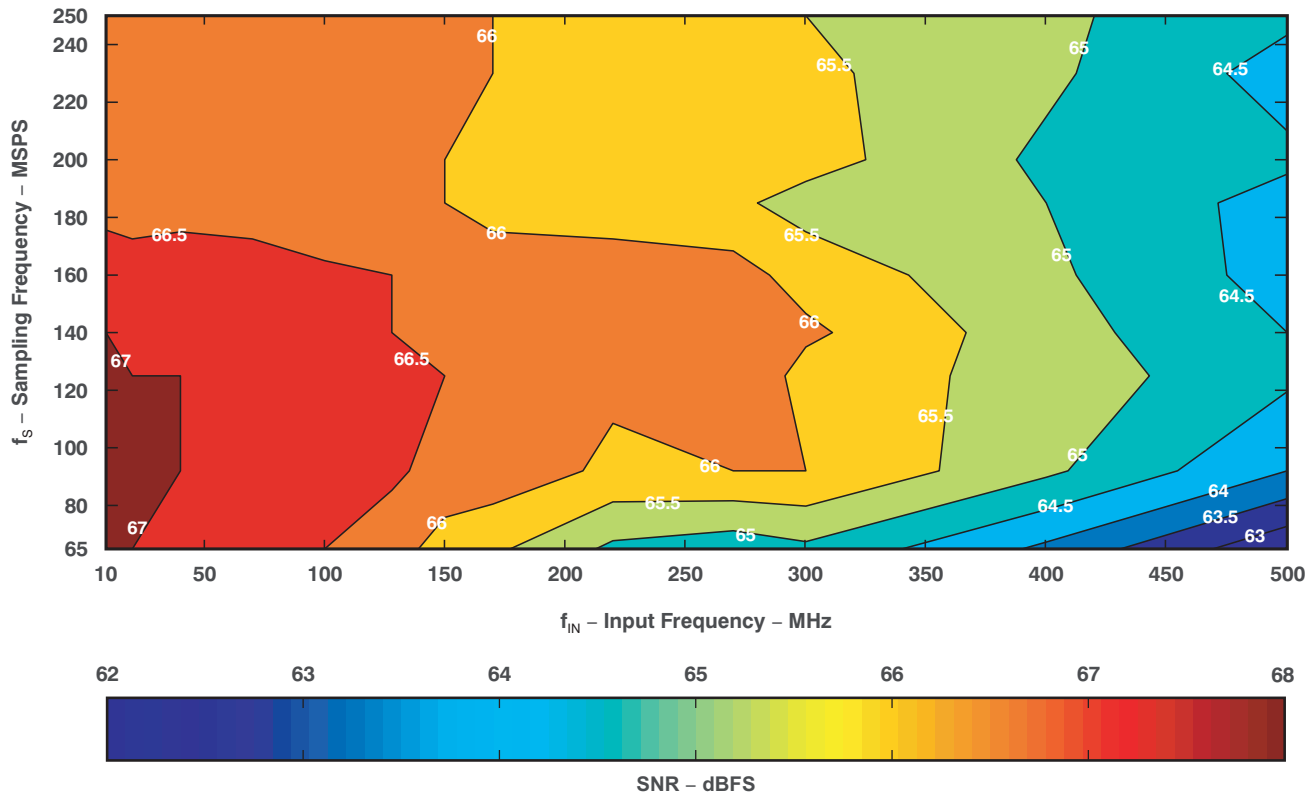

Figure 110.

TYPICAL CHARACTERISTICS: CONTOUR (continued)

At +25°C, AVDD = 1.8V, DRVDD = 1.8V, maximum rated sampling frequency, sine wave input clock, 1.5V_{PP} differential clock amplitude, 50% clock duty cycle, -1dBFS differential analog input, 1dB gain, low-latency mode, DDR LVDS output interface, and 32k-point FFT, unless otherwise noted. Note that after reset, the device is in 0dB gain mode.

**ADS414x: SNR ACROSS INPUT AND SAMPLING FREQUENCIES
(1dB Gain)**

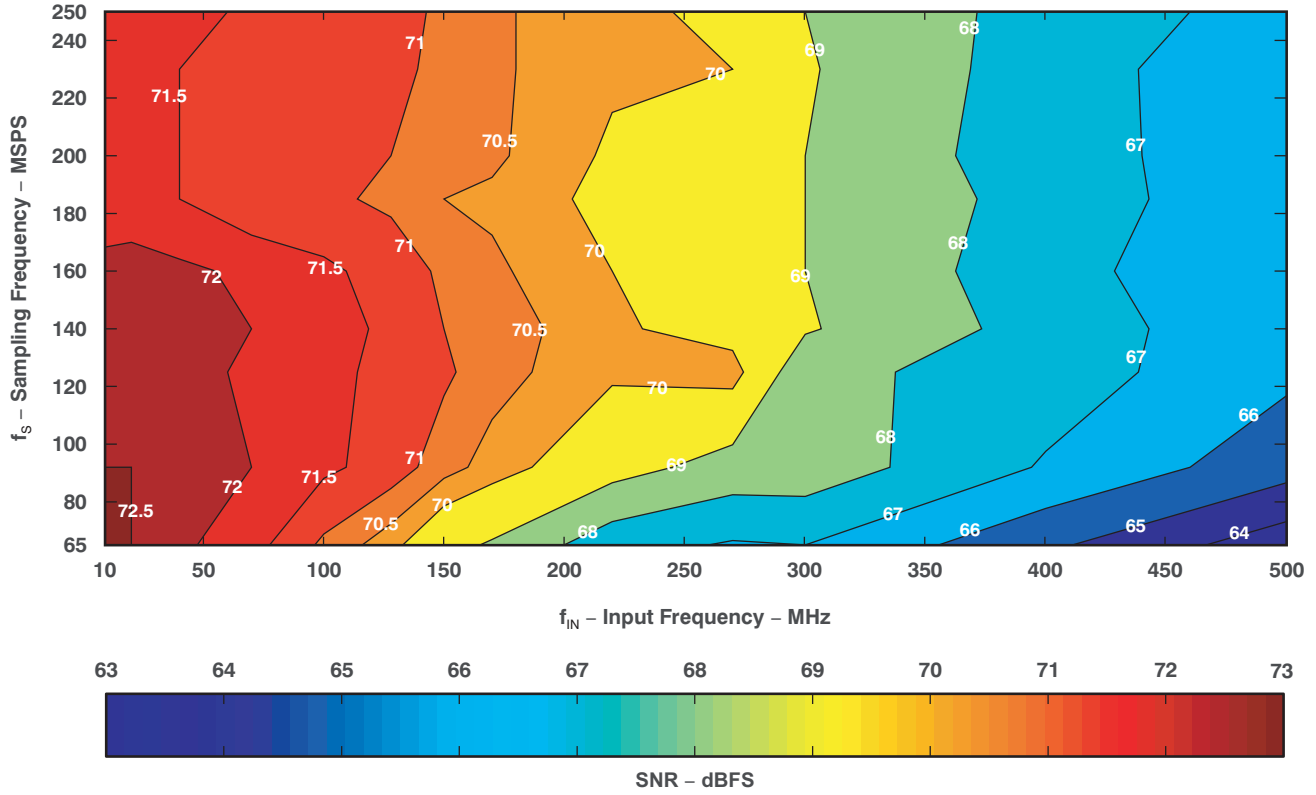

Figure 111.

TYPICAL CHARACTERISTICS: CONTOUR (continued)

At +25°C, AVDD = 1.8V, DRVDD = 1.8V, maximum rated sampling frequency, sine wave input clock, 1.5V_{PP} differential clock amplitude, 50% clock duty cycle, -1dBFS differential analog input, 1dB gain, low-latency mode, DDR LVDS output interface, and 32k-point FFT, unless otherwise noted. Note that after reset, the device is in 0dB gain mode.

**ADS414x: SNR ACROSS INPUT AND SAMPLING FREQUENCIES
(6dB Gain)**

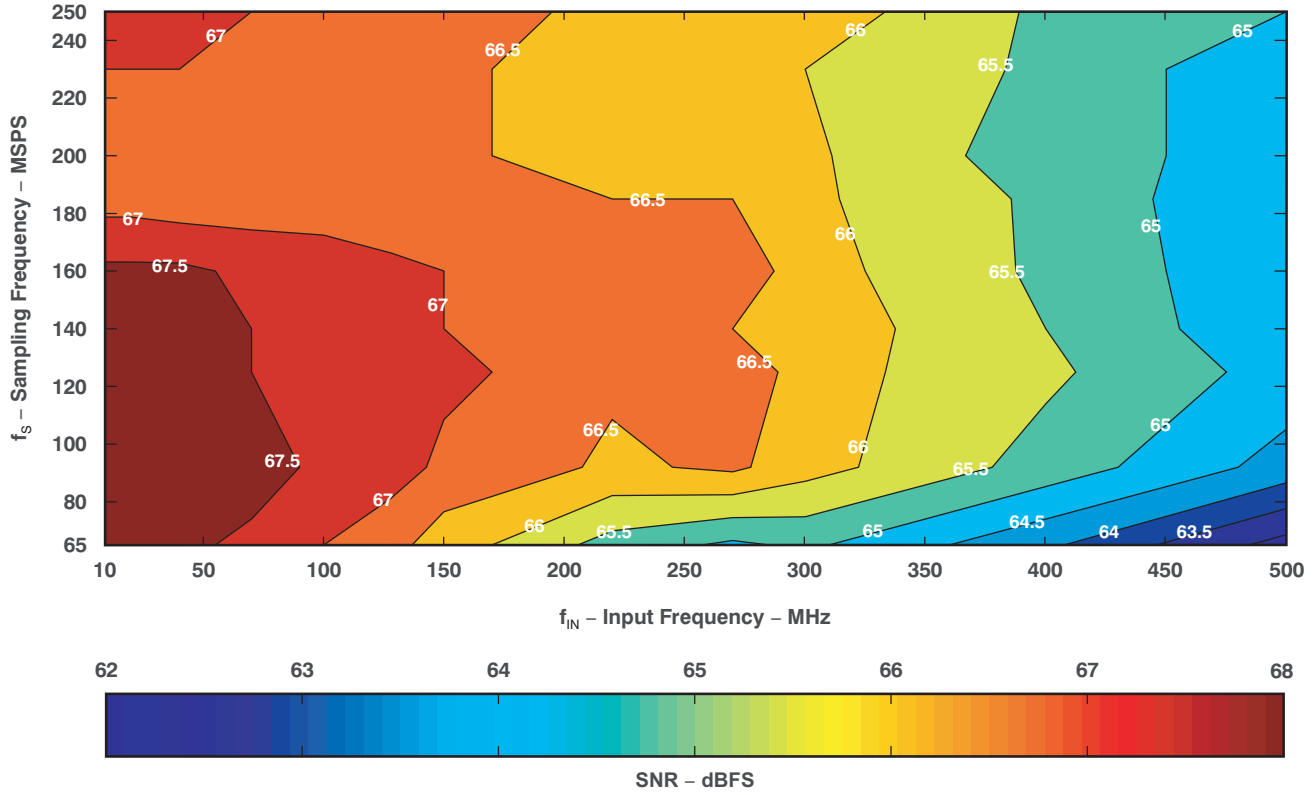

Figure 112.

APPLICATION INFORMATION

THEORY OF OPERATION

The ADS412x/4x is a family of high-performance and low-power 12-bit and 14-bit ADCs with maximum sampling rates up to 250MSPS. The conversion process is initiated by a rising edge of the external input clock and the analog input signal is sampled. The sampled signal is sequentially converted by a series of small resolution stages, with the outputs combined in a digital correction logic block. At every clock edge the sample propagates through the pipeline, resulting in a data latency of 10 clock cycles. The output is available as 14-bit data or 12-bit data, in DDR LVDS mode or CMOS mode, and coded in either straight offset binary or binary twos complement format.

ANALOG INPUT

The analog input consists of a switched-capacitor-based, differential, sample-and-hold architecture. This differential topology results in very good ac performance even for high input frequencies at high sampling rates. The INP and INM pins must be externally biased around a common-mode voltage of 0.95V, available on the VCM pin. For a full-scale differential input, each input INP and INM pin must swing symmetrically between (VCM + 0.5V) and (VCM – 0.5V), resulting in a 2V_{PP} differential input swing. The input sampling circuit has a high 3dB bandwidth that extends up to 550MHz (measured from the input pins to the sampled voltage). [Figure 113](#) shows an equivalent circuit for the analog input.

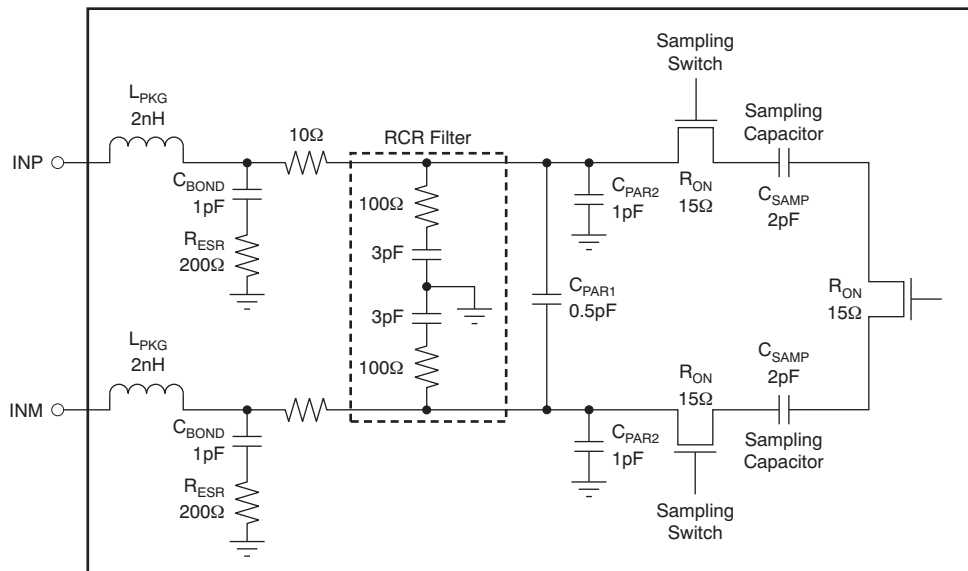

Figure 113. Analog Input Equivalent Circuit

Drive Circuit Requirements

For optimum performance, the analog inputs must be driven differentially. This technique improves the common-mode noise immunity and even-order harmonic rejection. A 5Ω to 15Ω resistor in series with each input pin is recommended to damp out ringing caused by package parasitics. It is also necessary to present low impedance (less than 50Ω) for the common-mode switching currents. This impedance can be achieved by using two resistors from each input terminated to the common-mode voltage (VCM).

Note that the device includes an internal R-C filter from each input to ground. The purpose of this filter is to absorb the glitches caused by the opening and closing of the sampling capacitors. The cutoff frequency of the R-C filter involves a trade-off. A lower cutoff frequency (larger C) absorbs glitches better, but also reduces the input bandwidth and the maximum input frequency that can be supported. On the other hand, with no internal R-C filter, high input frequency can be supported but now the sampling glitches must be supplied by the external driving circuit. The inductance of the package bond wires limits the ability of the external driving circuit to support the sampling glitches.

In the ADS412x/4x, the R-C component values have been optimized while supporting high input bandwidth (550MHz). However, in applications where very high input frequency support is not required, filtering of the glitches can be improved further with an external R-C-R filter; see [Figure 116](#) and [Figure 117](#).

In addition, the drive circuit may have to be designed to provide a low insertion loss over the desired frequency range and matched impedance to the source. While designing the drive circuit, the ADC impedance must be considered. [Figure 114](#) and [Figure 115](#) show the impedance ($Z_{IN} = R_{IN} \parallel C_{IN}$) looking into the ADC input pins.

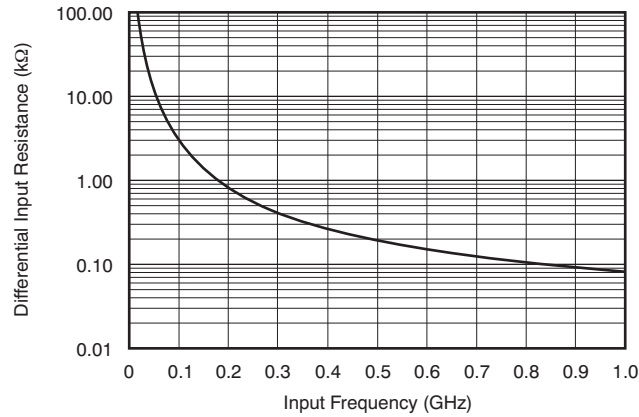

Figure 114. ADC Analog Input Resistance (R_{IN}) Across Frequency

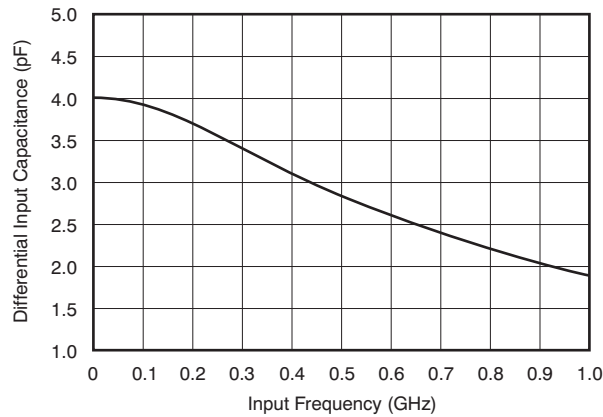

Figure 115. ADC Analog Input Capacitance (C_{IN}) Across Frequency

Driving Circuit

Two example driving circuit configurations are shown in [Figure 116](#) and [Figure 117](#)—one optimized for low bandwidth and the other one for high bandwidth to support higher input frequencies. In [Figure 116](#), an external R-C-R filter with 3.3pF is used to help absorb sampling glitches. The R-C-R filter limits the bandwidth of the drive circuit, making it suitable for low input frequencies (up to 250MHz). Transformers such as ADT1-1WT or WBC1-1 can be used up to 250MHz.

For higher input frequencies, the R-C-R filter can be dropped. Together with the lower series resistors (5Ω to 10Ω), this drive circuit provides higher bandwidth to support frequencies up to 500MHz (as shown in [Figure 117](#)). A transmission line transformer such as ADTL2-18 can be used.

Note that both the drive circuits have been terminated by 50Ω near the ADC side. The termination is accomplished by a 25Ω resistor from each input to the 0.95V common-mode (VCM) from the device. This termination allows the analog inputs to be biased around the required common-mode voltage.

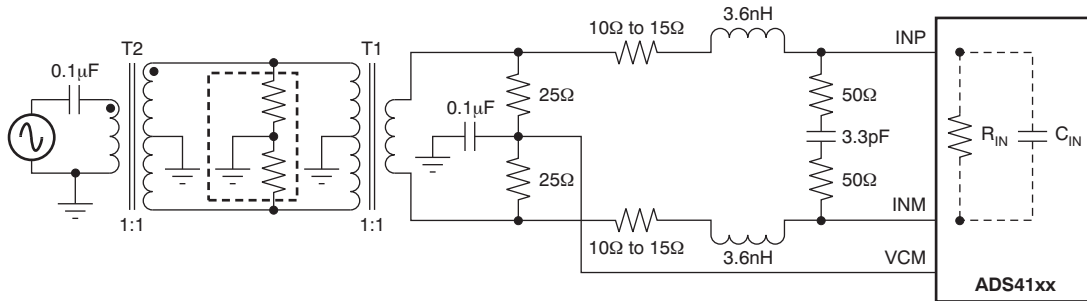

Figure 116. Drive Circuit with Low Bandwidth (for Low Input Frequencies)

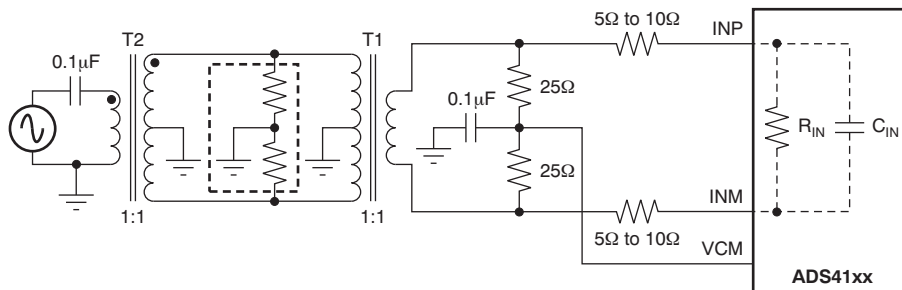

Figure 117. Drive Circuit with High Bandwidth (for High Input Frequencies)

The mismatch in the transformer parasitic capacitance (between the windings) results in degraded even-order harmonic performance. Connecting two identical RF transformers back-to-back helps minimize this mismatch and good performance is obtained for high-frequency input signals. An additional termination resistor pair may be required between the two transformers, as shown in [Figure 116](#) and [Figure 117](#). The center point of this termination is connected to ground to improve the balance between the P (positive) and M (negative) sides. The values of the terminations between the transformers and on the secondary side must be chosen to obtain an effective 50Ω (for a 50Ω source impedance).

[Figure 116](#) and [Figure 117](#) use 1:1 transformers with a 50Ω source. As explained in the [Drive Circuit Requirements](#) section, this architecture helps to present a low source impedance to absorb sampling glitches. With a 1:4 transformer, the source impedance is 200Ω. The higher source impedance is unable to absorb the sampling glitches effectively and can lead to degradation in performance (compared to using 1:1 transformers).

In almost all cases, either a bandpass or low-pass filter is needed to get the desired dynamic performance, as shown in [Figure 118](#). Such a filter presents low source impedance at the high frequencies corresponding to the sampling glitch and helps avoid the performance loss with the high source impedance.

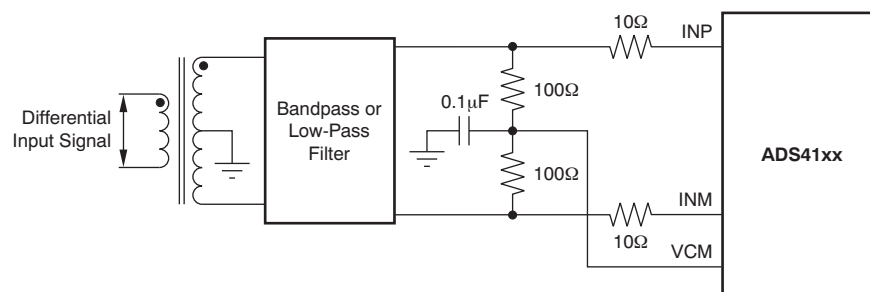

Figure 118. Drive Circuit with 1:4 Transformer

Input Common-Mode

To ensure a low-noise, common-mode reference, the VCM pin is filtered with a 0.1μF low-inductance capacitor connected to ground. The VCM pin is designed to directly drive the ADC inputs. Each ADC input pin sinks a common-mode current of approximately 0.6μA per MSPS of clock frequency.

CLOCK INPUT

The ADS412x/4x clock inputs can be driven differentially (sine, LVPECL, or LVDS) or single-ended (LVCMOS), with little or no difference in performance between them. The common-mode voltage of the clock inputs is set to VCM using internal 5kΩ resistors. This setting allows the use of transformer-coupled drive circuits for sine-wave clock or ac-coupling for LVPECL and LVDS clock sources. Figure 119 shows an equivalent circuit for the input clock.

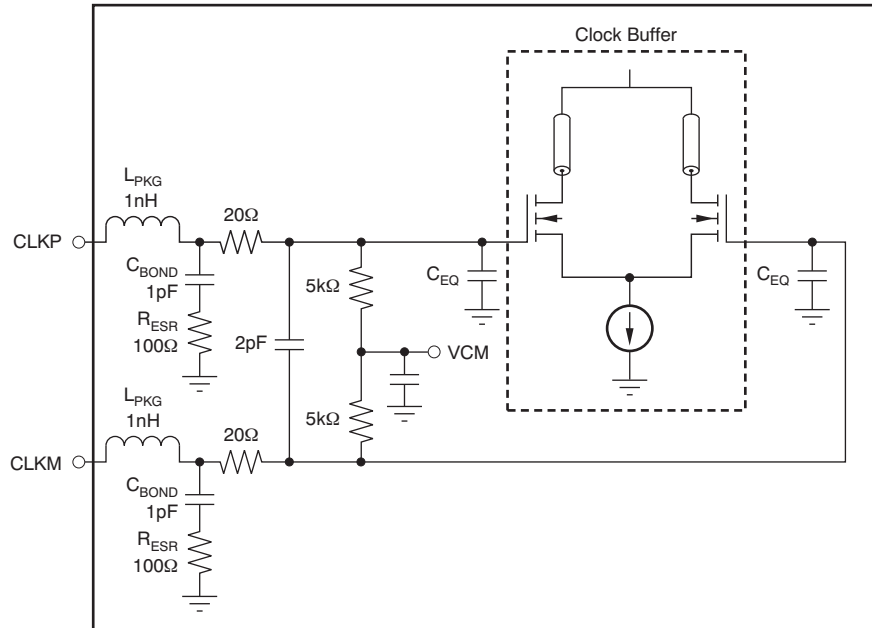

NOTE: C_{EQ} is 1pF to 3pF and is the equivalent input capacitance of the clock buffer.

Figure 119. Input Clock Equivalent Circuit

A single-ended CMOS clock can be ac-coupled to the CLKP input, with CLKM connected to ground with a 0.1μF capacitor, as shown in Figure 120. For best performance, the clock inputs must be driven differentially, reducing susceptibility to common-mode noise. For high input frequency sampling, it is recommended to use a clock source with very low jitter. Band-pass filtering of the clock source can help reduce the effects of jitter. There is no change in performance with a non-50% duty cycle clock input. Figure 121 shows a differential circuit.

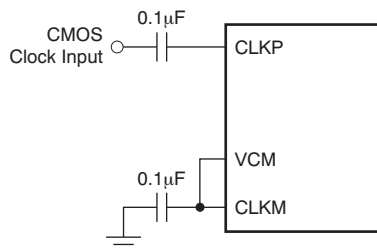

Figure 120. Single-Ended Clock Driving Circuit

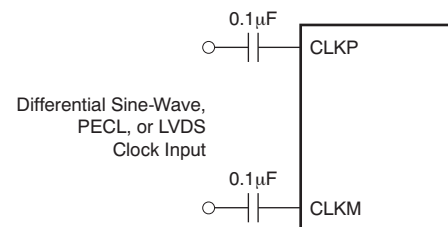

Figure 121. Differential Clock Driving Circuit

DIGITAL FUNCTIONS AND LOW LATENCY MODE

The device has several useful digital functions such as test patterns, gain, and offset correction. All of these functions require extra clock cycles for operation and increase the overall latency and power of the device. Alternately, the device has a low-latency mode in which the raw ADC output is routed to the output data pins with a latency of 10 clock cycles. In this mode, the digital functions are bypassed. Figure 122 shows more details of the processing after the ADC.

The device is in low-latency mode after reset. In order to use any of the digital functions, first the low-latency mode must be disabled by setting the DIS LOW LATENCY register bit to '1'. After this, the respective register bits must be programmed as described in the following sections and in the [Serial Register Map](#) section.

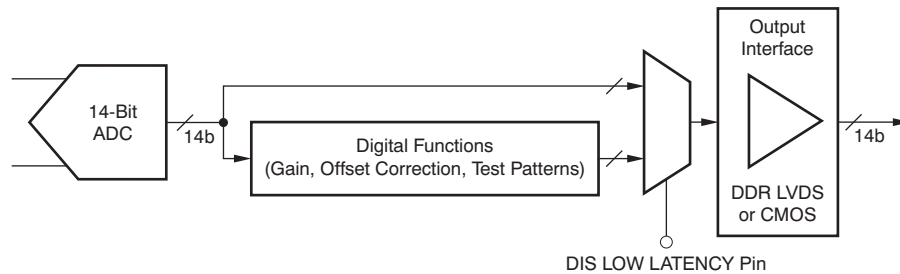

Figure 122. Digital Processing Block Diagram

GAIN FOR SFDR/SNR TRADE-OFF

The ADS412x/4x include gain settings that can be used to get improved SFDR performance. The gain is programmable from 0dB to 6dB (in 0.5dB steps) using the GAIN register bits. For each gain setting, the analog input full-scale range scales proportionally, as shown in Table 11.

The SFDR improvement is achieved at the expense of SNR; for each gain setting, the SNR degrades approximately between 0.5dB and 1dB. The SNR degradation is reduced at high input frequencies. As a result, the gain is very useful at high input frequencies because the SFDR improvement is significant with marginal degradation in SNR. Therefore, the gain can be used to trade-off between SFDR and SNR.

After a reset, the device is in low-latency mode and gain function is disabled. To use gain:

- First, disable the low-latency mode (DIS LOW LATENCY = 1).
- This setting enables the gain and puts the device in a 0dB gain mode.
- For other gain settings, program the GAIN bits.

Table 11. Full-Scale Range Across Gains

GAIN (dB)	TYPE	FULL-SCALE (V _{PP})
0	Default after reset	2
1	Programmable gain	1.78
2	Programmable gain	1.59
3	Programmable gain	1.42
4	Programmable gain	1.26
5	Programmable gain	1.12
6	Programmable gain	1.00

OFFSET CORRECTION

The ADS412x/4x has an internal offset correction algorithm that estimates and corrects dc offset up to $\pm 10\text{mV}$. The correction can be enabled using the EN OFFSET CORR serial register bit. Once enabled, the algorithm estimates the channel offset and applies the correction every clock cycle. The time constant of the correction loop is a function of the sampling clock frequency. The time constant can be controlled using the OFFSET CORR TIME CONSTANT register bits, as described in [Table 12](#).

Table 12. Time Constant of Offset Correction Loop

OFFSET CORR TIME CONSTANT	TIME CONSTANT, $T_{C_{CLK}}$ (Number of Clock Cycles)	TIME CONSTANT, $T_{C_{CLK}} \times 1/f_s$ (sec) ⁽¹⁾
0000	1M	4ms
0001	2M	8ms
0010	4M	16.7ms
0011	8M	33.5ms
0100	16M	67ms
0101	32M	134ms
0110	64M	268ms
0111	128M	537ms
1000	256M	1.1s
1001	512M	2.15s
1010	1G	4.3s
1011	2G	8.6s
1100	Reserved	—
1101	Reserved	—
1110	Reserved	—
1111	Reserved	—

(1) Sampling frequency, $f_s = 250\text{MSPS}$.

After the offset is estimated, the correction can be frozen by setting FREEZE OFFSET CORR = 1. Once frozen, the last estimated value is used for the offset correction of every clock cycle. Note that offset correction is disabled by a default after reset.

After a reset, the device is in low-latency mode and offset correction is disabled. To use offset correction:

- First, disable the low-latency mode (DIS LOW LATENCY = 1).
- Then set EN OFFSET CORR to '1' and program the required time constant.

[Figure 123](#) shows the time response of the offset correction algorithm after it is enabled.

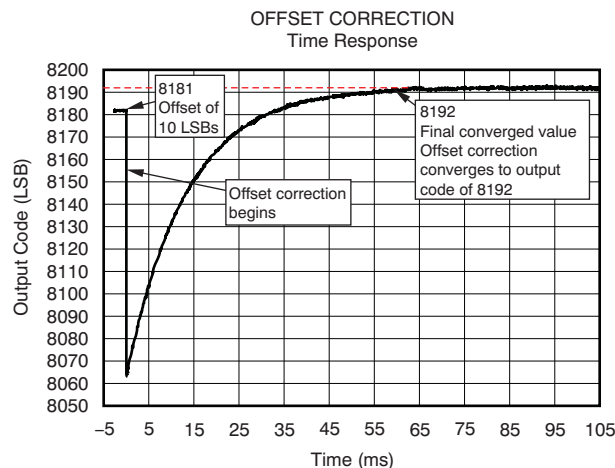

Figure 123. Time Response of Offset Correction

POWER DOWN

The ADS412x/4x has three power-down modes: power-down global, standby, and output buffer disable.

Power-Down Global

In this mode, the entire chip (including the ADC, internal reference, and the output buffers) are powered down, resulting in reduced total power dissipation of about 10mW. The output buffers are in a high-impedance state. The wake-up time from the global power-down to data becoming valid in normal mode is typically 100 μ s. To enter the global power-down mode, set the PDN GLOBAL register bit.

Standby

In this mode, only the ADC is powered down and the internal references are active, resulting in a fast wake-up time of 5 μ s. The total power dissipation in standby mode is approximately 185mW. To enter the standby mode, set the STBY register bit.

Output Buffer Disable

The output buffers can be disabled and put in a high-impedance state; wakeup time from this mode is fast, approximately 100ns. This can be controlled using the PDN OBUF register bit or using the OE pin.

Input Clock Stop

In addition, the converter enters a low-power mode when the input clock frequency falls below 1MSPS. The power dissipation is approximately 80mW.

POWER-SUPPLY SEQUENCE

During power-up, the AVDD and DRVDD supplies can come up in any sequence. The two supplies are separated in the device. Externally, they can be driven from separate supplies or from a single supply.

DIGITAL OUTPUT INFORMATION

The ADS412x/4x provide either 14-bit data or 12-bit data, respectively, and an output clock synchronized with the data.

Output Interface

Two output interface options are available: double data rate (DDR) LVDS and parallel CMOS. They can be selected using the LVDS CMOS serial interface register bit or using the DFS pin.

DDR LVDS Outputs

In this mode, the data bits and clock are output using low voltage differential signal (LVDS) levels. Two data bits are multiplexed and output on each LVDS differential pair, as shown in [Figure 124](#) and [Figure 125](#).

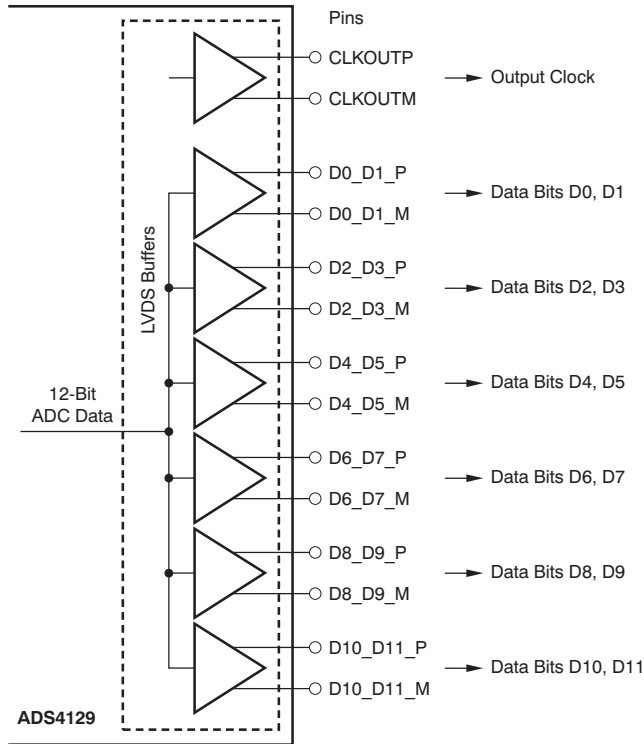

Figure 124. ADS412x LVDS Data Outputs

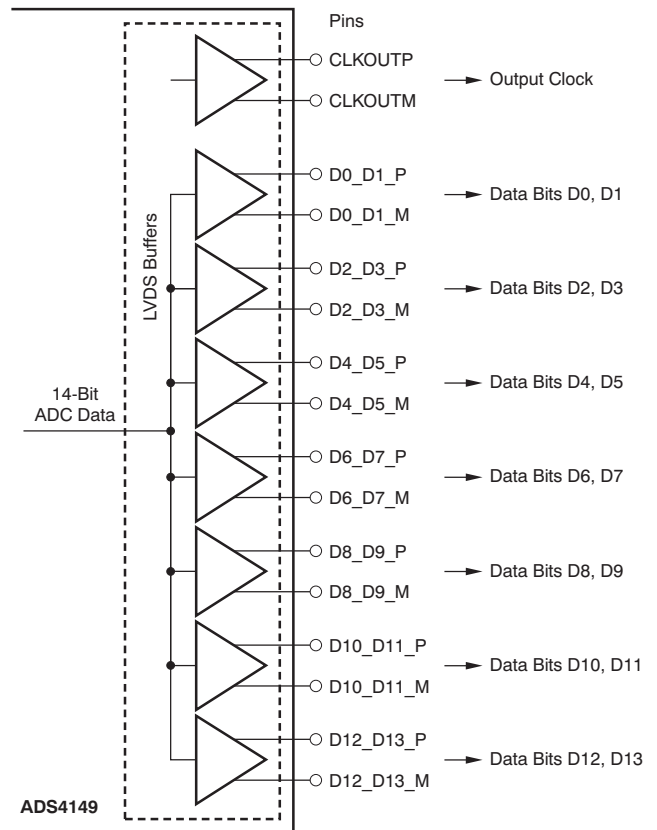

Figure 125. ADS414x LVDS Data Outputs

Even data bits (D0, D2, D4, etc.) are output at the falling edge of CLKOUTP and the odd data bits (D1, D3, D5, etc.) are output at the rising edge of CLKOUTP. Both the rising and falling edges of CLKOUTP must be used to capture all 14 data bits, as shown in Figure 126.

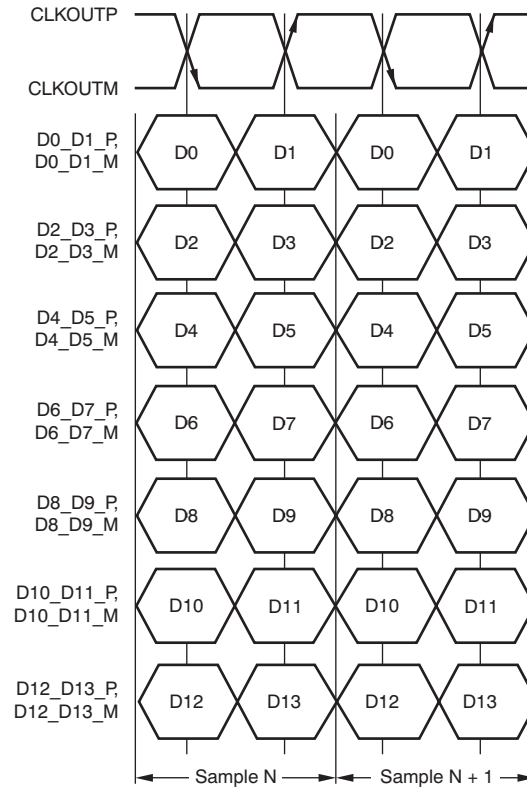

Figure 126. DDR LVDS Interface

LVDS Output Data and Clock Buffers

The equivalent circuit of each LVDS output buffer is shown in [Figure 127](#). After reset, the buffer presents an output impedance of 100Ω to match with the external 100Ω termination.

The V_{DIFF} voltage is nominally 350mV, resulting in an output swing of ± 350 mV with 100Ω external termination. The V_{DIFF} voltage is programmable using the LVDS SWING register bits from ± 125 mV to ± 570 mV.

Additionally, a mode exists to double the strength of the LVDS buffer to support 50Ω differential termination. This mode can be used when the output LVDS signal is routed to two separate receiver chips, each using a 100Ω termination. The mode can be enabled using the LVDS DATA STRENGTH and LVDS CLKOUT STRENGTH register bits for data and output clock buffers, respectively.

The buffer output impedance behaves in the same way as a source-side series termination. By absorbing reflections from the receiver end, it helps to improve signal integrity.

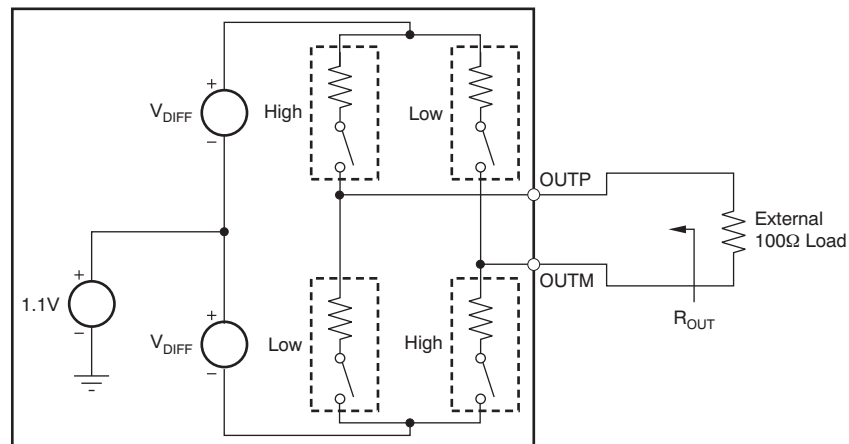

NOTE: Use the default buffer strength to match 100Ω external termination ($R_{OUT} = 100\Omega$). To match with a 50Ω external termination, set the LVDS STRENGTH bit ($R_{OUT} = 50\Omega$).

Figure 127. LVDS Buffer Equivalent Circuit

Parallel CMOS Interface

In CMOS mode, each data bit is output on a separate pin as the CMOS voltage level, for every clock cycle. The rising edge of the output clock CLKOUT can be used to latch data in the receiver. [Figure 128](#) depicts the CMOS output interface.

Switching noise (caused by CMOS output data transitions) can couple into the analog inputs and degrade SNR. The coupling and SNR degradation increases as the output buffer drive is made stronger. To minimize this degradation, the CMOS output buffers are designed with controlled drive strength. The default drive strength ensures a wide data stable window (even at 250MSPS) is provided so the data outputs have minimal load capacitance. It is recommended to use short traces (one to two inches or 2,54cm to 5,08cm) terminated with less than 5pF load capacitance, as shown in [Figure 129](#).

For sampling frequencies greater than 200MSPS, it is recommended to use an external clock to capture data. The delay from input clock to output data and the data valid times are specified for higher sampling frequencies. These timings can be used to delay the input clock appropriately and use it to capture data.

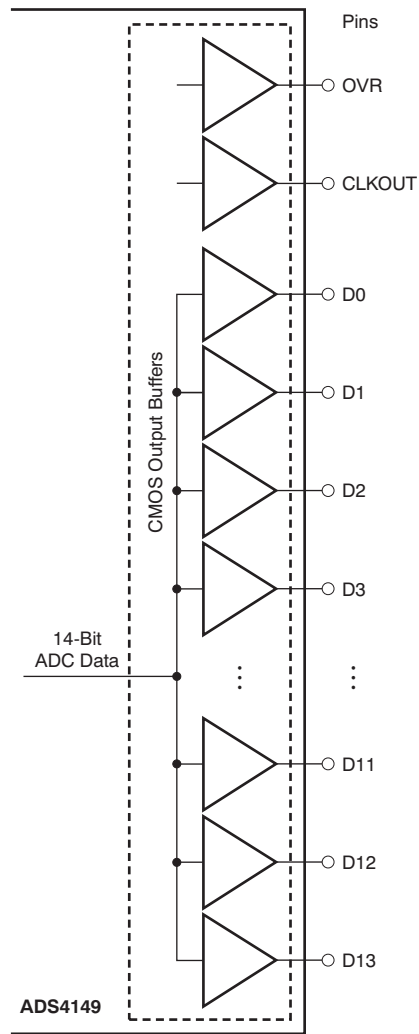

Figure 128. CMOS Output Interface

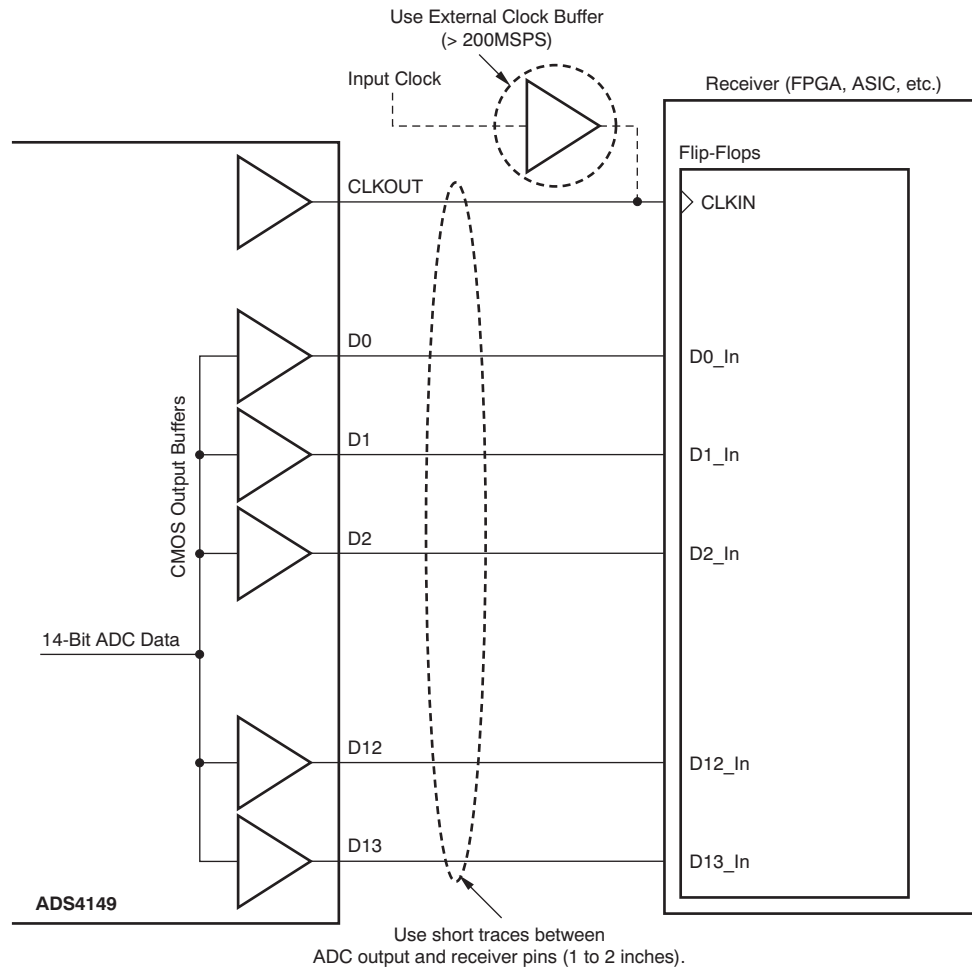

Figure 129. Using the CMOS Data Outputs

CMOS Interface Power Dissipation

With CMOS outputs, the DRVDD current scales with the sampling frequency and the load capacitance on every output pin. The maximum DRVDD current occurs when each output bit toggles between '0' and '1' every clock cycle. In actual applications, this condition is unlikely to occur. The actual DRVDD current would be determined by the average number of output bits switching, which is a function of the sampling frequency and the nature of the analog input signal.

Digital Current as a Result of CMOS Output Switching = $C_L \times \text{DRVDD} \times (N \times f_{\text{AVG}})$

where:

C_L = load capacitance,

$N \times F_{\text{AVG}}$ = average number of output bits switching.

(1)

Figure 106 shows the current across sampling frequencies at 2 MHz analog input frequency.

Input Over-Voltage Indication (OVR Pin)

The device has an OVR pin that provides information about analog input overload. At any clock cycle, if the sampled input voltage exceeds the positive or negative full-scale range, the OVR pin goes high. The OVR remains high as long as the overload condition persists. The OVR pin is a CMOS output buffer (running off DRVDD supply), independent of the type of output data interface (DDR LVDS or CMOS).

For a positive overload, the D[13:0] output data bits are 3FFFh in offset binary output format and 1FFFh in twos complement output format. For a negative input overload, the output code is 0000h in offset binary output format and 2000h in twos complement output format.

Output Data Format

Two output data formats are supported: twos complement and offset binary. They can be selected using the DATA FORMAT serial interface register bit or controlling the DFS pin in parallel configuration mode. In the event of an input voltage overdrive, the digital outputs go to the appropriate full-scale level.

BOARD DESIGN CONSIDERATIONS

Grounding

A single ground plane is sufficient to give good performance, provided the analog, digital, and clock sections of the board are cleanly partitioned. See the [ADS414x, ADS412x EVM User Guide \(SLWU067\)](#) for details on layout and grounding.

Supply Decoupling

Because the ADS412x/4x already include internal decoupling, minimal external decoupling can be used without loss in performance. Note that decoupling capacitors can help filter external power-supply noise, so the optimum number of capacitors depends on the actual application. The decoupling capacitors should be placed very close to the converter supply pins.

Exposed Pad

In addition to providing a path for heat dissipation, the PowerPAD is also electrically internally connected to the digital ground. Therefore, it is necessary to solder the exposed pad to the ground plane for best thermal and electrical performance. For detailed information, see application notes [QFN Layout Guidelines \(SLOA122\)](#) and [QFN/SON PCB Attachment \(SLUA271\)](#), both available for download at the TI web site (www.ti.com).

DEFINITION OF SPECIFICATIONS

Analog Bandwidth – The analog input frequency at which the power of the fundamental is reduced by 3 dB with respect to the low-frequency value.

Aperture Delay – The delay in time between the rising edge of the input sampling clock and the actual time at which the sampling occurs. This delay is different across channels. The maximum variation is specified as aperture delay variation (channel-to-channel).

Aperture Uncertainty (Jitter) – The sample-to-sample variation in aperture delay.

Clock Pulse Width/Duty Cycle – The duty cycle of a clock signal is the ratio of the time the clock signal remains at a logic high (clock pulse width) to the period of the clock signal. Duty cycle is typically expressed as a percentage. A perfect differential sine-wave clock results in a 50% duty cycle.

Maximum Conversion Rate – The maximum sampling rate at which specified operation is given. All parametric testing is performed at this sampling rate unless otherwise noted.

Minimum Conversion Rate – The minimum sampling rate at which the ADC functions.

Differential Nonlinearity (DNL) – An ideal ADC exhibits code transitions at analog input values spaced exactly 1 LSB apart. The DNL is the deviation of any single step from this ideal value, measured in units of LSBs.

Integral Nonlinearity (INL) – The INL is the deviation of the ADC transfer function from a best fit line determined by a least squares curve fit of that transfer function, measured in units of LSBs.

Gain Error – Gain error is the deviation of the ADC actual input full-scale range from its ideal value. The gain error is given as a percentage of the ideal input full-scale range. Gain error has two components: error as a result of reference inaccuracy and error as a result of the channel. Both errors are specified independently as E_{GREF} and E_{GCHAN} .

To a first-order approximation, the total gain error is $E_{TOTAL} \sim E_{GREF} + E_{GCHAN}$.

For example, if $E_{TOTAL} = \pm 0.5\%$, the full-scale input varies from $(1 - 0.5/100) \times FS_{ideal}$ to $(1 + 0.5/100) \times FS_{ideal}$.

Offset Error – The offset error is the difference, given in number of LSBs, between the ADC actual average idle channel output code and the ideal average idle channel output code. This quantity is often mapped into millivolts.

Temperature Drift – The temperature drift coefficient (with respect to gain error and offset error) specifies the change per degree Celsius of the parameter from T_{MIN} to T_{MAX} . It is calculated by dividing the maximum deviation of the parameter across the T_{MIN} to T_{MAX} range by the difference $T_{MAX} - T_{MIN}$.

Signal-to-Noise Ratio – SNR is the ratio of the power of the fundamental (P_S) to the noise floor power (P_N), excluding the power at dc and the first nine harmonics.

$$SNR = 10 \log_{10} \frac{P_S}{P_N} \quad (2)$$

SNR is either given in units of dBc (dB to carrier) when the absolute power of the fundamental is used as the reference, or dBFS (dB to full-scale) when the power of the fundamental is extrapolated to the converter full-scale range.

Signal-to-Noise and Distortion (SINAD) – SINAD is the ratio of the power of the fundamental (P_S) to the power of all the other spectral components including noise (P_N) and distortion (P_D), but excluding dc.

$$SINAD = 10 \log_{10} \frac{P_S}{P_N + P_D} \quad (3)$$

SINAD is either given in units of dBc (dB to carrier) when the absolute power of the fundamental is used as the reference, or dBFS (dB to full-scale) when the power of the fundamental is extrapolated to the converter full-scale range.

Effective Number of Bits (ENOB) – ENOB is a measure of the converter performance as compared to the theoretical limit based on quantization noise.

$$\text{ENOB} = \frac{\text{SINAD} - 1.76}{6.02} \quad (4)$$

Total Harmonic Distortion (THD) – THD is the ratio of the power of the fundamental (P_S) to the power of the first nine harmonics (P_D).

$$\text{THD} = 10\text{Log}^{10} \frac{P_S}{P_N} \quad (5)$$

THD is typically given in units of dBc (dB to carrier).

Spurious-Free Dynamic Range (SFDR) – The ratio of the power of the fundamental to the highest other spectral component (either spur or harmonic). SFDR is typically given in units of dBc (dB to carrier).

Two-Tone Intermodulation Distortion – IMD3 is the ratio of the power of the fundamental (at frequencies f_1 and f_2) to the power of the worst spectral component at either frequency $2f_1 - f_2$ or $2f_2 - f_1$. IMD3 is either given in units of dBc (dB to carrier) when the absolute power of the fundamental is used as the reference, or dBFS (dB to full-scale) when the power of the fundamental is extrapolated to the converter full-scale range.

DC Power-Supply Rejection Ratio (DC PSRR) – DC PSRR is the ratio of the change in offset error to a change in analog supply voltage. The dc PSRR is typically given in units of mV/V.

AC Power-Supply Rejection Ratio (AC PSRR) – AC PSRR is the measure of rejection of variations in the supply voltage by the ADC. If ΔV_{SUP} is the change in supply voltage and ΔV_{OUT} is the resultant change of the ADC output code (referred to the input), then:

$$\text{PSRR} = 20\text{Log}^{10} \frac{\Delta V_{\text{OUT}}}{\Delta V_{\text{SUP}}} \quad (\text{Expressed in dBc}) \quad (6)$$

Voltage Overload Recovery – The number of clock cycles taken to recover to less than 1% error after an overload on the analog inputs. This is tested by separately applying a sine wave signal with 6dB positive and negative overload. The deviation of the first few samples after the overload (from the expected values) is noted.

Common-Mode Rejection Ratio (CMRR) – CMRR is the measure of rejection of variation in the analog input common-mode by the ADC. If $\Delta V_{\text{CM_IN}}$ is the change in the common-mode voltage of the input pins and ΔV_{OUT} is the resulting change of the ADC output code (referred to the input), then:

$$\text{CMRR} = 20\text{Log}^{10} \frac{\Delta V_{\text{OUT}}}{\Delta V_{\text{CM}}} \quad (\text{Expressed in dBc}) \quad (7)$$

Crosstalk (only for multi-channel ADCs) – This is a measure of the internal coupling of a signal from an adjacent channel into the channel of interest. It is specified separately for coupling from the immediate neighboring channel (near-channel) and for coupling from channel across the package (far-channel). It is usually measured by applying a full-scale signal in the adjacent channel. Crosstalk is the ratio of the power of the coupling signal (as measured at the output of the channel of interest) to the power of the signal applied at the adjacent channel input. It is typically expressed in dBc.

REVISION HISTORY

NOTE: Page numbers for previous revisions may differ from page numbers in the current version.

Changes from Revision F (October 2010) to Revision G	Page
• Updated document to current standards	1
• Added 125MSPS and 65MSPS columns to ADS412x/ADS414x Family Comparison table	1
• Changed Clock Input, <i>Low-speed mode enabled</i> minimum specification for both ADS4129/49 and ADS4126/46 rows in Electrical Characteristics table	4
• Changed DF register address and register data in Table 10	26
• Changed DFh register in <i>Description of Serial Registers</i> section	34
• Changed titles of Figure 21 and Figure 22	36
• Changed titles of Figure 42 and Figure 43	40
• Changed titles of Figure 63 and Figure 64	44
• Changed titles of Figure 85 and Figure 86	48
• Updated Figure 105 and Figure 106	51
• Updated Table 11	63

Changes from Revision E (September 2010) to Revision F	Page
• Changed status of ADS4129 throughout document	1
• Changed ADS4129 <i>SNR</i> , <i>SINAD</i> , <i>SFDR</i> , <i>THD</i> , and <i>HD3 f_{IN} = 170MHz</i> typical specifications in Electrical Characteristics table	5
• Added ADS4129 <i>SNR</i> , <i>SINAD</i> , <i>SFDR</i> , <i>THD</i> , <i>HD2</i> , <i>HD3</i> , and <i>Worst spur f_{IN} = 170MHz</i> minimum specifications in Electrical Characteristics table	5
• Added ADS4129 <i>DNL</i> minimum and maximum specifications in Electrical Characteristics table	5
• Added ADS4129 <i>INL</i> maximum specification in Electrical Characteristics table	5
• Changed ADS4129 <i>INL</i> typical specification in Electrical Characteristics table	5

PACKAGING INFORMATION

Orderable Device	Status (1)	Package Type	Package Drawing	Pins	Package Qty	Eco Plan (2)	Lead/Ball Finish (6)	MSL Peak Temp (3)	Op Temp (°C)	Device Marking (4/5)	Samples
ADS4126IRGZR	ACTIVE	VQFN	RGZ	48	2500	Green (RoHS & no Sb/Br)	CU NIPDAU	Level-3-260C-168 HR	-40 to 85	AZ4126	Samples
ADS4126IRGZT	ACTIVE	VQFN	RGZ	48	250	Green (RoHS & no Sb/Br)	CU NIPDAU	Level-3-260C-168 HR	-40 to 85	AZ4126	Samples
ADS4129IRGZR	ACTIVE	VQFN	RGZ	48	2500	Green (RoHS & no Sb/Br)	CU NIPDAU	Level-3-260C-168 HR	-40 to 85	AZ4129	Samples
ADS4129IRGZT	ACTIVE	VQFN	RGZ	48	250	Green (RoHS & no Sb/Br)	CU NIPDAU	Level-3-260C-168 HR	-40 to 85	AZ4129	Samples
ADS4146IRGZR	ACTIVE	VQFN	RGZ	48	2500	Green (RoHS & no Sb/Br)	CU NIPDAU	Level-3-260C-168 HR	-40 to 85	AZ4146	Samples
ADS4146IRGZT	ACTIVE	VQFN	RGZ	48	250	Green (RoHS & no Sb/Br)	CU NIPDAU	Level-3-260C-168 HR	-40 to 85	AZ4146	Samples
ADS4149IRGZR	ACTIVE	VQFN	RGZ	48	2500	Green (RoHS & no Sb/Br)	CU NIPDAU	Level-3-260C-168 HR	-40 to 85	AZ4149	Samples
ADS4149IRGZT	ACTIVE	VQFN	RGZ	48	250	Green (RoHS & no Sb/Br)	CU NIPDAU	Level-3-260C-168 HR	-40 to 85	AZ4149	Samples
ADS58B18IRGZR	ACTIVE	VQFN	RGZ	48	2500	Green (RoHS & no Sb/Br)	CU NIPDAU	Level-3-260C-168 HR	-40 to 85	AZ58B18	Samples
ADS58B18IRGZT	ACTIVE	VQFN	RGZ	48	250	Green (RoHS & no Sb/Br)	CU NIPDAU	Level-3-260C-168 HR	-40 to 85	AZ58B18	Samples

(1) The marketing status values are defined as follows:

ACTIVE: Product device recommended for new designs.

LIFEBUY: TI has announced that the device will be discontinued, and a lifetime-buy period is in effect.

NRND: Not recommended for new designs. Device is in production to support existing customers, but TI does not recommend using this part in a new design.

PREVIEW: Device has been announced but is not in production. Samples may or may not be available.

OBSOLETE: TI has discontinued the production of the device.

(2) Eco Plan - The planned eco-friendly classification: Pb-Free (RoHS), Pb-Free (RoHS Exempt), or Green (RoHS & no Sb/Br) - please check <http://www.ti.com/productcontent> for the latest availability information and additional product content details.

TBD: The Pb-Free/Green conversion plan has not been defined.

Pb-Free (RoHS): TI's terms "Lead-Free" or "Pb-Free" mean semiconductor products that are compatible with the current RoHS requirements for all 6 substances, including the requirement that lead not exceed 0.1% by weight in homogeneous materials. Where designed to be soldered at high temperatures, TI Pb-Free products are suitable for use in specified lead-free processes.

Pb-Free (RoHS Exempt): This component has a RoHS exemption for either 1) lead-based flip-chip solder bumps used between the die and package, or 2) lead-based die adhesive used between the die and leadframe. The component is otherwise considered Pb-Free (RoHS compatible) as defined above.

Green (RoHS & no Sb/Br): TI defines "Green" to mean Pb-Free (RoHS compatible), and free of Bromine (Br) and Antimony (Sb) based flame retardants (Br or Sb do not exceed 0.1% by weight in homogeneous material)

- (3) MSL, Peak Temp. - The Moisture Sensitivity Level rating according to the JEDEC industry standard classifications, and peak solder temperature.
- (4) There may be additional marking, which relates to the logo, the lot trace code information, or the environmental category on the device.
- (5) Multiple Device Markings will be inside parentheses. Only one Device Marking contained in parentheses and separated by a "~" will appear on a device. If a line is indented then it is a continuation of the previous line and the two combined represent the entire Device Marking for that device.
- (6) Lead/Ball Finish - Orderable Devices may have multiple material finish options. Finish options are separated by a vertical ruled line. Lead/Ball Finish values may wrap to two lines if the finish value exceeds the maximum column width.

Important Information and Disclaimer:The information provided on this page represents TI's knowledge and belief as of the date that it is provided. TI bases its knowledge and belief on information provided by third parties, and makes no representation or warranty as to the accuracy of such information. Efforts are underway to better integrate information from third parties. TI has taken and continues to take reasonable steps to provide representative and accurate information but may not have conducted destructive testing or chemical analysis on incoming materials and chemicals. TI and TI suppliers consider certain information to be proprietary, and thus CAS numbers and other limited information may not be available for release.

In no event shall TI's liability arising out of such information exceed the total purchase price of the TI part(s) at issue in this document sold by TI to Customer on an annual basis.

TAPE AND REEL INFORMATION

QUADRANT ASSIGNMENTS FOR PIN 1 ORIENTATION IN TAPE

*All dimensions are nominal

Device	Package Type	Package Drawing	Pins	SPQ	Reel Diameter (mm)	Reel Width W1 (mm)	A0 (mm)	B0 (mm)	K0 (mm)	P1 (mm)	W (mm)	Pin1 Quadrant
ADS4126IRGZR	VQFN	RGZ	48	2500	330.0	16.4	7.3	7.3	1.5	12.0	16.0	Q2
ADS4126IRGZT	VQFN	RGZ	48	250	180.0	16.4	7.3	7.3	1.5	12.0	16.0	Q2
ADS4129IRGZR	VQFN	RGZ	48	2500	330.0	16.4	7.3	7.3	1.5	12.0	16.0	Q2
ADS4129IRGZT	VQFN	RGZ	48	250	180.0	16.4	7.3	7.3	1.5	12.0	16.0	Q2
ADS4146IRGZR	VQFN	RGZ	48	2500	330.0	16.4	7.3	7.3	1.5	12.0	16.0	Q2
ADS4146IRGZT	VQFN	RGZ	48	250	180.0	16.4	7.3	7.3	1.5	12.0	16.0	Q2
ADS4149IRGZR	VQFN	RGZ	48	2500	330.0	16.4	7.3	7.3	1.5	12.0	16.0	Q2
ADS4149IRGZT	VQFN	RGZ	48	250	180.0	16.4	7.3	7.3	1.5	12.0	16.0	Q2
ADS58B18IRGZR	VQFN	RGZ	48	2500	330.0	16.4	7.3	7.3	1.5	12.0	16.0	Q2
ADS58B18IRGZT	VQFN	RGZ	48	250	180.0	16.4	7.3	7.3	1.5	12.0	16.0	Q2

TAPE AND REEL BOX DIMENSIONS

*All dimensions are nominal

Device	Package Type	Package Drawing	Pins	SPQ	Length (mm)	Width (mm)	Height (mm)
ADS4126IRGZR	VQFN	RGZ	48	2500	350.0	350.0	43.0
ADS4126IRGZT	VQFN	RGZ	48	250	213.0	191.0	55.0
ADS4129IRGZR	VQFN	RGZ	48	2500	350.0	350.0	43.0
ADS4129IRGZT	VQFN	RGZ	48	250	213.0	191.0	55.0
ADS4146IRGZR	VQFN	RGZ	48	2500	350.0	350.0	43.0
ADS4146IRGZT	VQFN	RGZ	48	250	213.0	191.0	55.0
ADS4149IRGZR	VQFN	RGZ	48	2500	350.0	350.0	43.0
ADS4149IRGZT	VQFN	RGZ	48	250	213.0	191.0	55.0
ADS58B18IRGZR	VQFN	RGZ	48	2500	350.0	350.0	43.0
ADS58B18IRGZT	VQFN	RGZ	48	250	213.0	191.0	55.0

GENERIC PACKAGE VIEW

RGZ 48

VQFN - 1 mm max height

7 x 7, 0.5 mm pitch

PLASTIC QUADFLAT PACK- NO LEAD

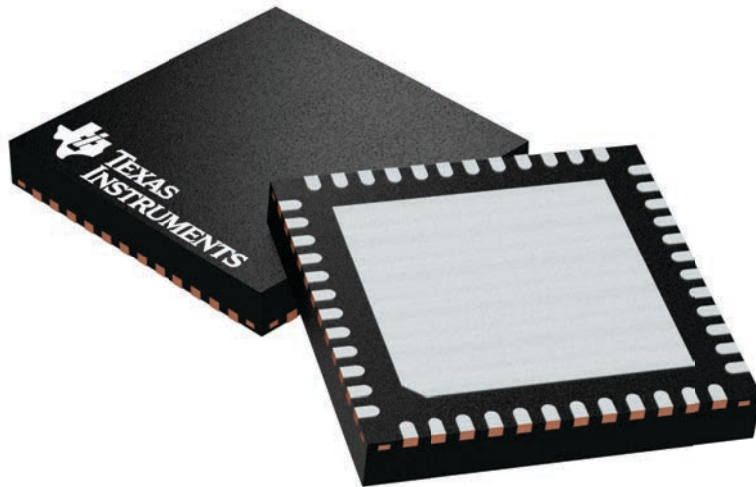

Images above are just a representation of the package family, actual package may vary.
Refer to the product data sheet for package details.

4224671/A

RGZ0048D

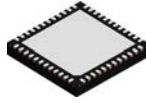

PACKAGE OUTLINE

VQFN - 1 mm max height

PLASTIC QUAD FLATPACK - NO LEAD

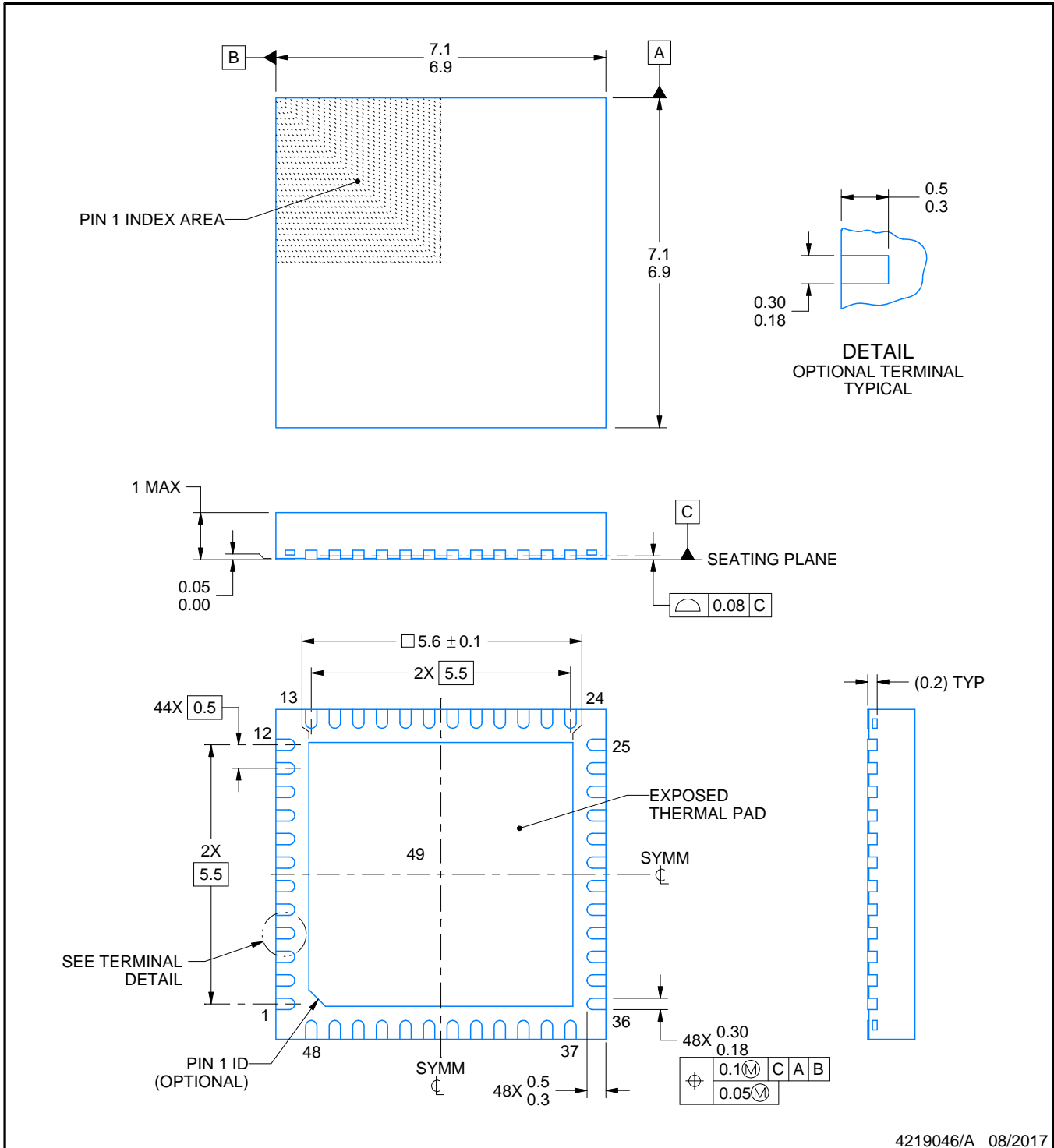

4219046/A 08/2017

NOTES:

1. All linear dimensions are in millimeters. Any dimensions in parenthesis are for reference only. Dimensioning and tolerancing per ASME Y14.5M.
2. This drawing is subject to change without notice.
3. The package thermal pad must be soldered to the printed circuit board for thermal and mechanical performance.

EXAMPLE BOARD LAYOUT

RGZ0048D

VQFN - 1 mm max height

PLASTIC QUAD FLATPACK - NO LEAD



LAND PATTERN EXAMPLE
EXPOSED METAL SHOWN
SCALE:12X

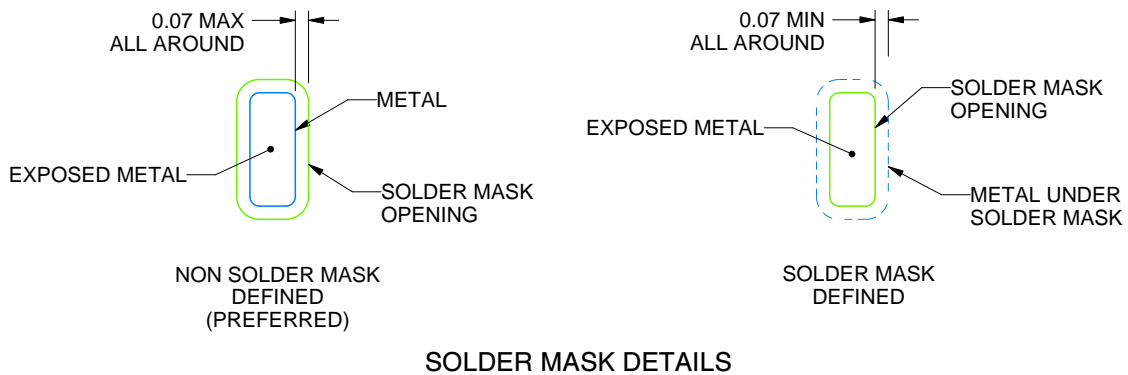

4219046/A 08/2017

NOTES: (continued)

- This package is designed to be soldered to a thermal pad on the board. For more information, see Texas Instruments literature number SLUA271 (www.ti.com/lit/sluea271).
- Vias are optional depending on application, refer to device data sheet. If any vias are implemented, refer to their locations shown on this view. It is recommended that vias under paste be filled, plugged or tented.

EXAMPLE STENCIL DESIGN

RGZ0048D

VQFN - 1 mm max height

PLASTIC QUAD FLATPACK - NO LEAD

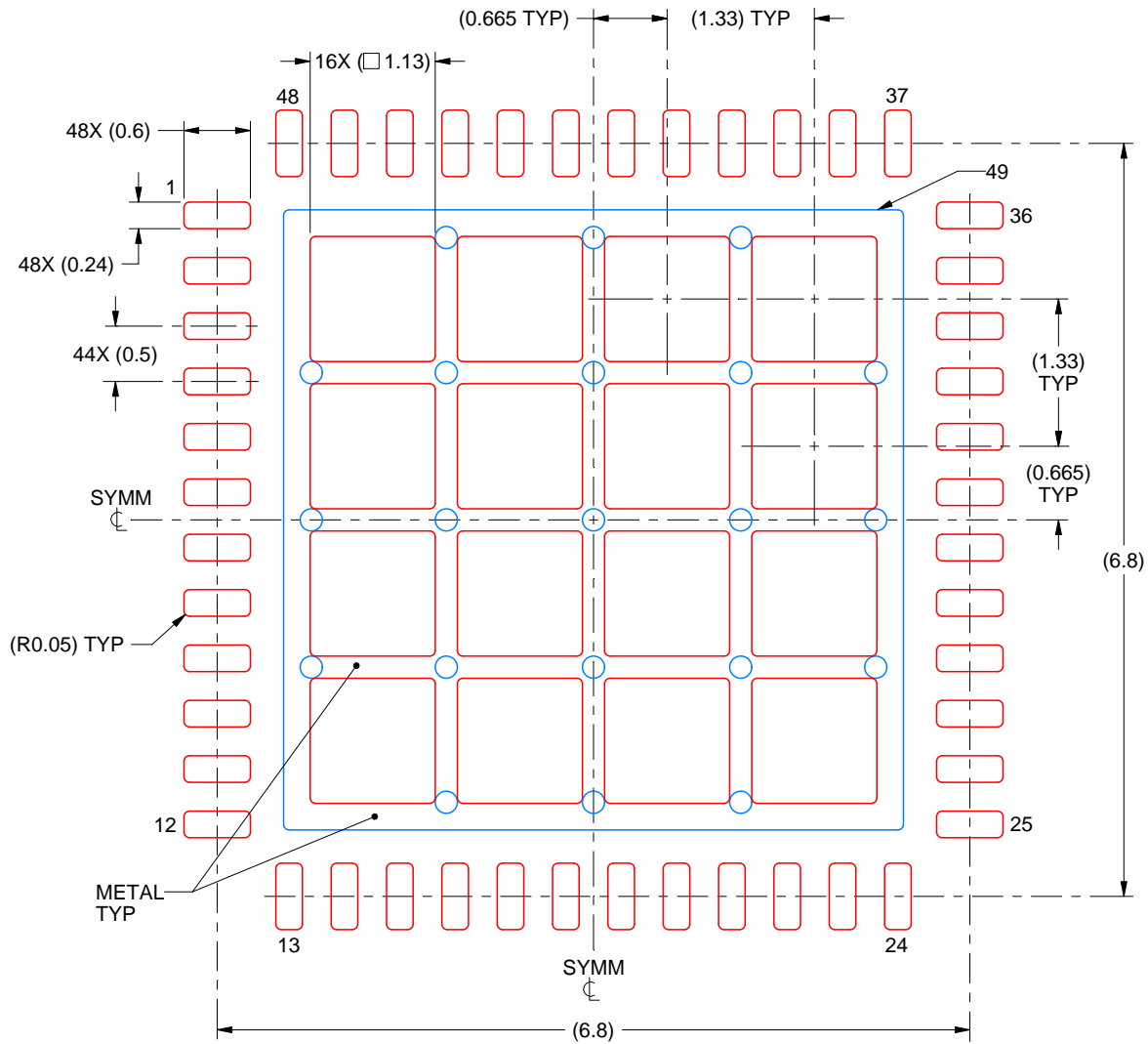

SOLDER PASTE EXAMPLE
 BASED ON 0.125 mm THICK STENCIL

EXPOSED PAD 49
 66% PRINTED SOLDER COVERAGE BY AREA UNDER PACKAGE
 SCALE:15X

4219046/A 08/2017

NOTES: (continued)

6. Laser cutting apertures with trapezoidal walls and rounded corners may offer better paste release. IPC-7525 may have alternate design recommendations.

IMPORTANT NOTICE AND DISCLAIMER

TI PROVIDES TECHNICAL AND RELIABILITY DATA (INCLUDING DATASHEETS), DESIGN RESOURCES (INCLUDING REFERENCE DESIGNS), APPLICATION OR OTHER DESIGN ADVICE, WEB TOOLS, SAFETY INFORMATION, AND OTHER RESOURCES "AS IS" AND WITH ALL FAULTS, AND DISCLAIMS ALL WARRANTIES, EXPRESS AND IMPLIED, INCLUDING WITHOUT LIMITATION ANY IMPLIED WARRANTIES OF MERCHANTABILITY, FITNESS FOR A PARTICULAR PURPOSE OR NON-INFRINGEMENT OF THIRD PARTY INTELLECTUAL PROPERTY RIGHTS.

These resources are intended for skilled developers designing with TI products. You are solely responsible for (1) selecting the appropriate TI products for your application, (2) designing, validating and testing your application, and (3) ensuring your application meets applicable standards, and any other safety, security, or other requirements. These resources are subject to change without notice. TI grants you permission to use these resources only for development of an application that uses the TI products described in the resource. Other reproduction and display of these resources is prohibited. No license is granted to any other TI intellectual property right or to any third party intellectual property right. TI disclaims responsibility for, and you will fully indemnify TI and its representatives against, any claims, damages, costs, losses, and liabilities arising out of your use of these resources.

TI's products are provided subject to TI's Terms of Sale (www.ti.com/legal/termsofsale.html) or other applicable terms available either on ti.com or provided in conjunction with such TI products. TI's provision of these resources does not expand or otherwise alter TI's applicable warranties or warranty disclaimers for TI products.

Mailing Address: Texas Instruments, Post Office Box 655303, Dallas, Texas 75265
Copyright © 2019, Texas Instruments Incorporated