

### 1. Features and Benefits

- Triaxis® Technology
- Very high sensitivity due to Integrated Magnetic Concentrator (IMC-Hall®)
- Programmable high speed current sensor IC
- Wideband: DC to 250kHz
- Short response time 3µs
- Programmable linear transfer characteristic
- Selectable Analog ratiometric output
- SOIC8 package RoHS compliant
- Lead free component, suitable for lead free soldering profile 260°C (target), MSL3
- AEC-Q100 Automotive Qualified

### 2. Application Examples

- Inverter HEV and EV
- BLDC motor current monitoring
- Smart fuse (over-current detection)
- AC/DC Converters
- DC/AC Converter (inverter)
- DC/DC switched mode power supply

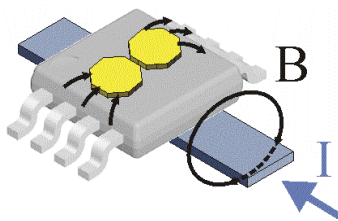

Figure 1: Typical application of MLX91208

### 3. Description

The MLX91208 is a monolithic sensor IC featuring the Tria $\otimes$ is™ Hall technology. Conventional planar Hall technology is only sensitive to the flux density applied orthogonally to the IC surface. The IMC-Hall® current sensor is sensitive to the flux density applied parallel to the IC surface. This is obtained through an Integrated Magneto-Concentrator (IMC-Hall®) which is deposited on the CMOS die (as an additional back-end step). The IMC-Hall® technology is automotive qualified.

The product is a single chip Hall sensor which provides an output signal proportional to the flux density applied horizontally and is therefore suitable for current measurement. It is ideally suited as an open loop current sensor for PCB or bus bar mounting. It features small size application design and a simple construction for various current ranges from few Amperes up to 1000 Amperes.

The transfer characteristic of the MLX91208 is programmable in terms of offset, gain or temperature compensation. The linear analog output is designed for applications where a very fast response is required, such as inverter applications.

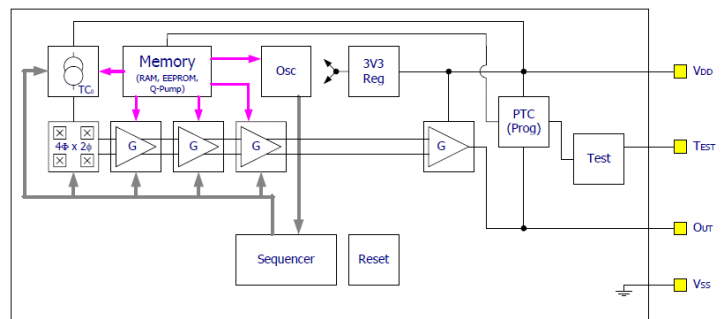

Figure 2: Block diagram

## 4. Ordering Information

Product	Temperature	Package	Option Code	Packing Form	Sensitivity Range (typ.)
ML91208	L (-40°C to 150°C)	DC	CAL - 000	TU/RE	100-700mV/mT (250mV/mT)
ML91208	L (-40°C to 150°C)	DC	CAH - 000	TU/RE	50-300mV/mT (100mV/mT)
ML91208	L (-40°C to 150°C)	DC	CAV - 000	TU/RE	30-200mV/mT (40mV/mT)
ML91208	L (-40°C to 150°C)	DC	CAV - 001	TU/RE	30-200mV/mT (60mV/mT)

*Table 1: Ordering Information*

### Legend:

<b>Temperature Code:</b>	<b>L: from -40°C to 150°C</b>
Package Code:	“DC” for SOIC-8 package
Option Code:	CAL : Low field version CAH : High field version CAV : Very high field version
Packing Form:	“RE” for Reel, “TU” for Tube
Ordering Example:	“MLX91208LDC-CAH-000-RE”

*Table 2: Legend*

## 5. Glossary of Terms

Terms	Definition
Tesla	Units for the magnetic flux density, 1 mT = 10 Gauss
TC	Temperature Coefficient in ppm/deg C
NC	Not Connected
ADC	Analog to Digital Converter
DAC	Digital to Analog Converter
LSB	Least Significant Bit
MSB	Most Significant Bit
DNL	Differential Non Linearity
INL	Integral Non Linearity
IMC	Integrated Magneto Concentrator (IMC®)
PTC	Programming Through Connector

*Table 3: Glossary of terms*

## Contents

<b>1. Features and Benefits</b> .....	<b>1</b>
<b>2. Application Examples</b> .....	<b>1</b>
<b>3. Description</b> .....	<b>1</b>
<b>4. Ordering Information</b> .....	<b>2</b>
<b>5. Glossary of Terms</b> .....	<b>2</b>
<b>6. Absolute Maximum Ratings</b> .....	<b>5</b>
<b>7. Pin Definitions and Descriptions</b> .....	<b>5</b>
<b>8. General Electrical Specifications</b> .....	<b>6</b>
<b>9. Magnetic specification</b> .....	<b>7</b>
9.1. Low Field Version 10mT (marking xxL).....	7
9.2. High Field Version 25mT (marking xxH).....	7
9.3. Very High Field Version 60mT (marking xxV).....	8
<b>10. Analog output specification</b> .....	<b>8</b>
10.1. Timing specification.....	8
10.2. Accuracy specification.....	9
10.3. Remarks to the achievable accuracy.....	9
<b>11. Programmable items</b> .....	<b>10</b>
11.1. Parameter table.....	10
11.2. Sensitivity programming (RG, FG).....	10
11.3. Offset / output quiescent voltage programming (VOQ).....	10
11.4. Output ratiometry (ENRATIO).....	10
11.5. Sensitivity temperature drift programming (TC1ST, TC2ND_COLD, TC2ND_HOT).....	11
11.6. Offset temperature drift programming (OFFDR2C, OFFDR2H).....	11
11.7. Noise filter (NOISEFILT).....	11
11.8. Identification code (ID).....	11
<b>12. Self-diagnostic</b> .....	<b>12</b>
<b>13. Application information</b> .....	<b>12</b>
13.1. Low current measurement $\pm 2$ -10A.....	12
13.2. Medium current measurement up to $\pm 50$ A.....	13
13.3. High current measurement up to $\pm 1000$ A.....	13
<b>14. Recommended Application Diagrams</b> .....	<b>14</b>
14.1. Resistor and capacitor values.....	14

- 14.2. Pull-up/down resistor for diagnostic high/low ..... 14
- 15. Typical performance..... 15
- 16. Standard information regarding manufacturability of Melexis products with different soldering processes..... 16
- 17. ESD Precautions..... 16
- 18. Package information..... 17
  - 18.1. SOIC-8 Package Dimensions ..... 17
  - 18.2. SOIC-8 Pinout and Marking ..... 17
  - 18.3. SOIC-8 Hall plate position..... 17
  - 18.4. SOIC-8 IMC Position and magnetic sensitive direction..... 18
- 19. Disclaimer..... 19

## 6. Absolute Maximum Ratings

Parameters	Symbol	Value	Units
Positive Supply Voltage (overvoltage)	Vdd	+10	V
Reverse Supply Voltage Protection		-0.3	V
Positive Output Voltage		+10	V
Output Current	Iout	±70	mA
Reverse Output Voltage		-0.3	V
Reverse Output Current		-50	mA
Package Thermal Resistance	Rth	105	°C/W
Operating Ambient Temperature Range	TA	-40 to 150	°C
Storage Temperature Range	TS	-55 to 165	°C
Magnetic Flux Density		infinite	T

*Table 4: Absolute maximum ratings*

Exceeding the absolute maximum ratings may cause permanent damage. Exposure to absolute maximum rated conditions for extended periods may affect device reliability.

## 7. Pin Definitions and Descriptions

Pin №	Name	Type	Function
5	VDD	Supply	Supply Voltage
3	VSS	Ground	Supply Voltage
1	VDEC	Digital	Digital supply voltage
4	TEST/MUST	Digital	Test and Factory calibration
6	OUT	Analog	Current sensor output

*Table 5: PIN definitions and descriptions*

It is recommended to connect the unused pins to the Ground for optimal EMC results.

## 8. General Electrical Specifications

Operating Parameters: TA = -40 to 125deg.C, Vdd = 4.5V to 5.5V, Iout = -2mA to +2 mA, recommended application diagram in section 14, unless otherwise specified. All mentioned component values can have a ±20% tolerance.

Parameter	Symbol	Test Conditions	Min	Typ.	Max	Units
Nominal Supply Voltage	Vdd		4.5	5	5.5	V
Supply Current	I <sub>dd</sub>	W/o output load in application mode T <sub>A</sub> = -40 to 150°C	7	12	14	mA
DC load Current	I <sub>out</sub>	R <sub>out</sub> in range [6kΩ, 100kΩ]	-2		2	mA
Maximum Output Current (driving capability)	I <sub>max</sub>	Inside this range, output voltage reaches 3%VDD and 97%VDD	-2		2	mA
Output Resistance		V <sub>out</sub> = 50% Vdd, R <sub>L</sub> = 5kΩ		1	5	Ω
Output Capacitive Load	C <sub>load</sub>	Capacitive load range for the stability of the output amplifier. Output amplifier optimized for the typical capacitive load.	1	2	10	nF
Output resistive load	R <sub>load</sub>	Output resistive load range for the stability of the output amplifier	6			kΩ
Output Short Circuit Current	I <sub>short</sub>	Output shorted to Vdd- Permanent	35		180	mA
		Output shorted to Vss Permanent	35		180	mA
Leakage current	I <sub>leak</sub>	High impedance mode <sup>(1)</sup> T=150°C	0.5	1.5	20	uA
Output Voltage Swing (Linear Range)	V <sub>out_pd</sub>	pull down ≥ 10 kΩ	10		90	%Vdd
High-impedance mode levels <sup>(1)</sup>	V <sub>out_HiZ_pd</sub>	pull-down R <sub>L</sub> ≤ 25 kΩ, T≤125°C			5	%Vdd
Under-voltage detection <sup>(2)</sup>	V <sub>dd_uvd</sub>	Low to high voltage	3	3.3	4	V
	V <sub>dd_uvh</sub>	Hysteresis	0.25	0.3	0.4	V
Over-voltage detection <sup>(2)</sup>	V <sub>dd_ovd2</sub>	Low to High voltage	6.7		7.6	V
	V <sub>dd_ovh2</sub>	Hysteresis	0.05		0.7	V
Ratiometry enable detection <sup>(2)</sup>	V <sub>ratio_d</sub>	Low to High Voltage	4		4.45	V
	V <sub>ratio_h</sub>	Hysteresis	0.05		0.5	V

<sup>1</sup> Refer to chapter Self-diagnostic, table 12

<sup>2</sup> See graph below the table

Table 6: General electrical parameter

(2) According to the figure below:

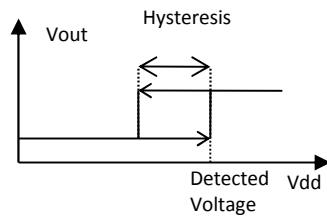

## 9. Magnetic specification

### 9.1. Low Field Version 10mT (marking xxL)

Operating Parameters TA = -40 to 125deg.C, Vdd = 4.5 V to 5.5 V, unless otherwise specified.

Parameter	Symbol	Test Conditions	Min	Typ	Max	Units
Nominal Field Range	Bnom		-7.5		+7.5	mT
Operational Field Range <sup>(3)</sup>	Bop		-10		+10	mT
Linearity Error	NL	B in range Bop Vout in [10%VDD, 90%VDD]	-0.7		+0.7	%FS
Hysteresis, remanent Field	Br	B = Bop	-10		+10	uT
Programmable Sensitivity	S		100	250	700	mV/mT
Sensitivity programming Resolution	Sres			0.1		%

Table 7: Magnetic specification for 10mT version (low-field version)

### 9.2. High Field Version 25mT (marking xxH)

Parameter	Symbol	Test Conditions	Min	Typ	Max	Units
Nominal Field Range	Bnom		-20		+20	mT
Operational Field Range <sup>(3)</sup>	Bop		-25		+25	mT
Linearity Error	NL	B in range Bop Vout in [10%VDD, 90%VDD]	-0.7		+0.7	%FS
Hysteresis, remanent Field	Br	B = Bop	-25		+25	uT
Programmable Sensitivity	S		50	100	300	mV/mT
Sensitivity programming Resolution	Sres			0.1		%

Table 8: Magnetic specification 25mT version (high-field version)

<sup>3</sup> Outside Bop, the IMC progressively enters saturation, yielding to an increase of the linearity error.

### 9.3. Very High Field Version 60mT (marking xxV)

Parameter	Symbol	Test Conditions	Min	Typ	Max	Units
Nominal Field Range	Bnom		-50		+50	mT
Operational Field Range <sup>(3)</sup>	Bop		-60		+60	mT
Linearity Error	NL	B in range Bop Vout in [10%VDD, 90%VDD]	-0.7		+0.7	%FS
Hysteresis, remanent Field	Br	B = Bop	-50		+50	uT
Programmable Sensitivity	S	CAV-000	30	40	200	mV/mT
		CAV-001	30	60	200	mV/mT
Sensitivity programming Resolution	Sres			0.1		%

Table 9: Magnetic specification 60mT version (Very high-field version)

Note: The noise filter is disabled by default for all MLX91208 versions.

## 10. Analog output specification

### 10.1. Timing specification

Operating Parameters  $T_A = -40$  to  $125\text{deg.C}$ ,  $V_{dd} = 4.5$  V to  $5.5$  V (unless otherwise specified)

Parameter	Symbol	Test Conditions	Min	Typ	Max	Units
Refresh rate	Trr		0.8	1	2	us
Step Response Time	Tresp	Delay between the input signal reaching 90% and the output signal reaching 90%, (2V step at the output, input rise time = $1\mu\text{s}$ )				
		-Noise filter OFF		3	4	$\mu\text{s}$
		-Noise filter ON		5	6	$\mu\text{s}$
Bandwidth	BW	-Noise filter OFF	200	250	300	kHz
		-Noise filter ON	120	150	180	kHz
Power on Delay	TPOD	Vout =100% of FS Pull-down resistor $\leq 100\text{kOhm}$				
		During the Power-on delay, the output will remain within the 10% fault band at all time.			1	ms
Ratiometry Cut-off Frequency	Fratio			250		Hz

Table 10: Timing specification high speed analog output



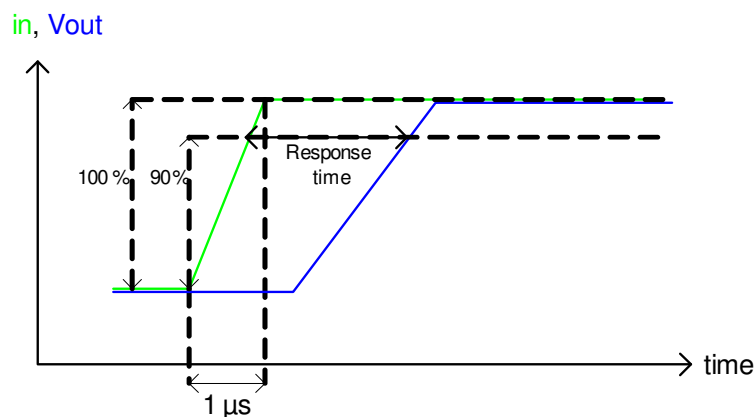

Figure 3: Response time definition

## 10.2. Accuracy specification

Operating Parameters  $T_A = -40$  to  $125^{\circ}\text{C}$ ,  $V_{dd} = 4.5$  V to  $5.5$  V (unless otherwise specified)

Parameter	Symbol	Test Conditions	Min	Typ	Max	Units
Thermal Offset Drift	$\Delta^T \text{Voq}$	Offset drift referred to $25^{\circ}\text{C}$ $S=40\text{mV/mT}$ (xxV version) $S=100\text{mV/mT}$ (xxH version) $S=250\text{mV/mT}$ (xxL version) $V_{dd}=5\text{V}$ , $TC=0\pm 150$ ppm/ $^{\circ}\text{C}$ $\text{Voq}=50\pm 0.2\%$ $V_{dd}$	-10		+10	mV
Thermal Offset Drift Resolution	$\Delta^T \text{VoqRes}$			0.075		mV/ $^{\circ}\text{C}$
Thermal Sensitivity Drift	TC		-1.5	0	+1.5	% of S
Thermal Sensitivity Drift Resolution	TCres			40		ppm/ $^{\circ}\text{C}$
RMS Output noise	$N_{\text{rms}}$	$S=40\text{mV/mT}$ (xxV version) $S=100\text{mV/mT}$ (xxH version) $S=250\text{mV/mT}$ (xxL version) -Noise filter OFF -Noise filter ON			0.2 0.12	% $V_{dd}$ % $V_{dd}$
Ratiometry Error Offset	$\Delta \text{Voq}$	$\text{Voq} = 50\%V_{dd}$ $\Delta V_{dd} = 10\%V_{dd}$	-0.4		+0.4	% of $\text{Voq}$
Ratiometry Error Sensitivity	$\Delta S$	$\Delta V_{dd} = 10\%V_{dd}$	-0.4		+0.4	% of S

Table 11: Accuracy-Specific Parameters

## 10.3. Remarks to the achievable accuracy

The achievable target accuracy is dependent on user's end-of-line calibration. The resolution for the offset and offset drift calibration is better than  $0.1\%V_{dd}$ . Trimming capability is higher than the measurement accuracy. End-user calibration can increase the accuracy of the system.

## 11. Programmable items

### 11.1. Parameter table

Parameter	Bits	Factory Setting	Comment
VOQ[11:0]	12	trimmed	Quiescent output level (0 Gauss) adjustment
RG[2:0]	3	trimmed	Rough gain adjustment
FG[9:0]	10	trimmed	Fine gain adjustment
ENRATIO	1	1	Ratiometry enablement
TC1[7:0]	8	trimmed	Adjustment of the first order temperature compensation of the magnetic sensitivity
TC2HOT[4:0]	5	trimmed	Adjustment of the extra temperature compensation of the magnetic sensitivity at high temperature
TC2COLD[4:0]	5	trimmed	Adjustment of the extra temperature compensation of the magnetic sensitivity at low temperature
OFFDR2C[5:0]	6	trimmed	Adjustment of the offset drift at low temperature after the VGA
OFFDR2H[5:0]	6	trimmed	Adjustment of the offset drift at high temperature after the VGA
NOISEFILT	1	0	Noise filter enablement
PLATEPOL	1	0	0: default polarity as described in section 18.4 1: opposite polarity
ID[47:0]	48	Programmed	Melexis traceability ID

Table 12: Customer programmable items

### 11.2. Sensitivity programming (RG, FG)

The sensitivity can be programmed from 50 to 300mV/mT (high field version) or 100 to 700mV/mT (low field version), with the ROUGHGAIN (3 bits) and FINEGAIN (10 bits) parameters.

### 11.3. Offset / output quiescent voltage programming (VOQ)

The offset is programmable with 12 bits in 1.5 mV steps over the full output range. This corresponds to a calibration resolution of 0.03 %VDD.

The typical step size would be  $5V/4096 = 1.22$  mV, but the actual step size can differ from the nominal value because of internal gain tolerance. A maximum step size of 1.5 mV is guaranteed.

**Note:** for optimal performance over temperature, the VOQ should be programmed in the range from 2 to 3V.

### 11.4. Output ratiometry (ENRATIO)

The ratiometry of the output versus the supply can be disabled by setting this bit to 0.

**Note:** for optimal performance over temperature, the ratiometry setting should not be changed on customer side. By default, this setting is enabled during final test calibration.

### 11.5. Sensitivity temperature drift programming (TC1ST, TC2ND\_COLD, TC2ND\_HOT)

First order sensitivity temperature drift can be trimmed with TC1. The programming resolution is 40ppm/K.

Second order sensitivity temperature drift can be trimmed with TC2COLD and TC2HOT. The programming resolution is 2ppm/K<sup>2</sup> for TC2COLD and 0.6ppm/K<sup>2</sup> for TC2HOT. The second order can also be seen as third order correction since cold and hot sides are independently adjusted.

**Note:** for optimal performance over temperature, the first order sensitivity drift compensation (TC1ST) should not exceed ±250ppm/K.

### 11.6. Offset temperature drift programming (OFFDR2C, OFFDR2H)

Offset temperature drift caused by the output amplifier can be compensated with these two parameters. This first order correction is done independently for temperatures over and below 25°C.

**Note:** Two additional parameters (OFFDR1C, OFFDR1H) are calibrated by Melexis to compensate for the offset temperature drift caused by the Hall element (before the variable gain amplifier). These parameters should not be adjusted on customer-side.

### 11.7. Noise filter (NOISEFILT)

Setting this bit to 1 enables the noise filter, reducing noise and increasing response time.

### 11.8. Identification code (ID)

48 bits programmed identification code.

## 12. Self-diagnostic

The MLX91208 provides self-diagnostic features to detect internal memory errors and over- / under-voltage. Those features increase the robustness of the IC functionality, as they prevent the IC from providing erroneous output signal in case of internal or external failure modes.

Error	Action	Effect on Outputs	Remarks
Calibration Data CRC Error (at power up and in normal working mode)	Fault mode	High Impedance mode	Pull down resistive load, Diagnostic Low
Power On delay		High Impedance mode	5ms max in high impedance followed by settling
Undervoltage Mode	IC is reset	High Impedance mode	300mV Hysteresis (typical)
Overvoltage detection	IC is reset	High Impedance mode	100mV Hysteresis (typical)

*Table 13: Self diagnostic*

## 13. Application information

Please refer to our current sensor reference design guide for more application information:

<http://melexis.com/Assets/Current-Sensors-Reference-Designs-6187.aspx>

### 13.1. Low current measurement ±2-10A

Low currents can be measured by either using a multi-turn/multi-layer PCB where the current is allowed to flow several times under the sensor, or by adding a closed ferromagnetic shield around the current trace with a small air gap to concentrate the magnetic flux above the sensor.

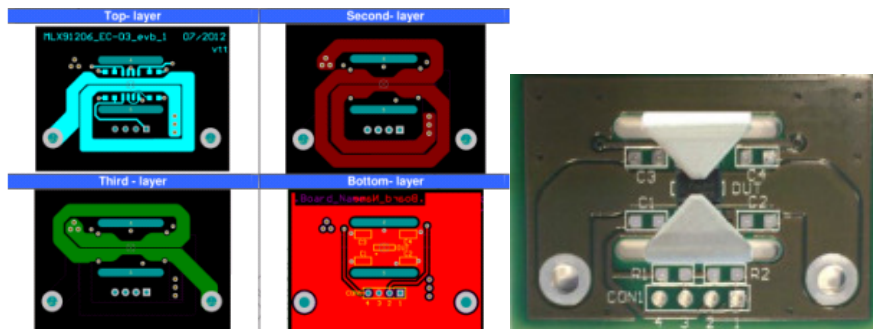

*Figure 4: Low current applications with either multi-trace/multi-layer PCB (left) or closed shield (right).*

### 13.2. Medium current measurement up to $\pm 50A$

For medium currents, a single PCB trace can be used. The sizing of the PCB trace should take into account the current handling capability and the total power dissipation. The PCB trace should be thick and wide enough to handle the RMS current continuously.

A simple “U-shaped” ferromagnetic shield is often required to protect the sensor from cross-talk or external stray fields, if they cannot be cancelled-out by other means (peak-peak detection, etc.).

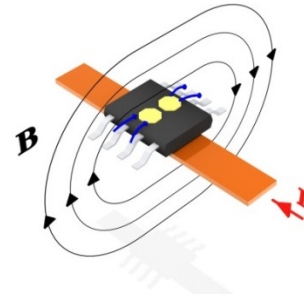

Figure 5: Medium current application on PCB

### 13.3. High current measurement up to $\pm 1000A$

For high currents flowing in a bus bar, MLX91208 is typically assembled on a PCB lying immediately above the current conductor.

A ferromagnetic shield is usually added to protect the sensor from external fields and ensure good homogeneity of the magnetic flux, for optimal robustness against vibrations and mechanical tolerances.

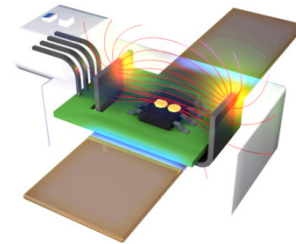

Figure 6: High current application on bus bar

## 14. Recommended Application Diagrams

### 14.1. Resistor and capacitor values

Part	Description	Value	Unit
C1	Supply capacitor, EMI, ESD	100	nF
C2	Decoupling, EMI, ESD	2-10 <sup>(4)</sup>	nF
C3	Decoupling, EMI, ESD	47	nF
R1	Pull down resistor	6-100	kΩ

Table 14: Resistor and capacitor values

### 14.2. Pull-down resistor for diagnostic low

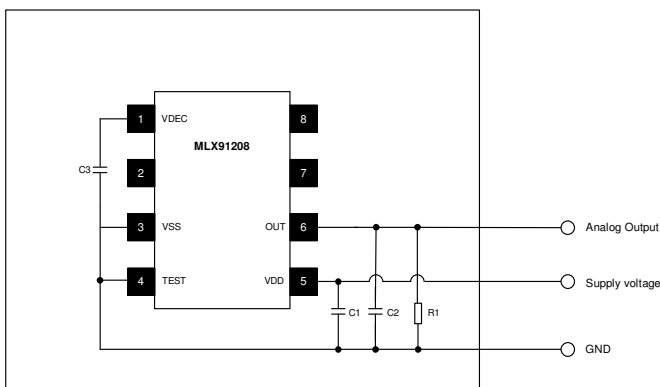

Figure 7: Diagnostic low/ Pull-down resistors

<sup>4</sup> 10nF is recommended for better EMC and ESD performance

## 15. Typical performance

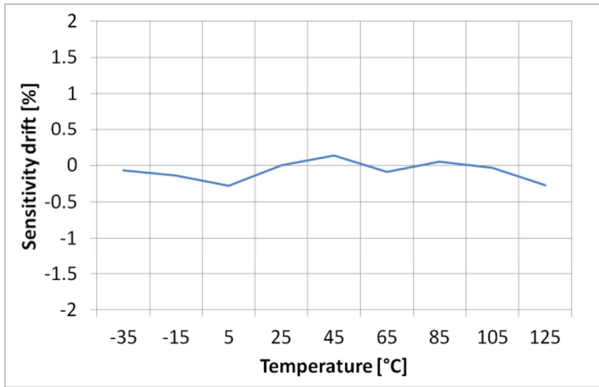

Figure 9: Thermal sensitivity drift.

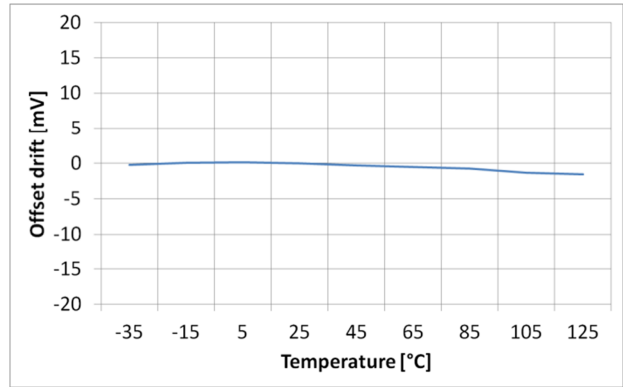

Figure 10: Thermal offset drift.

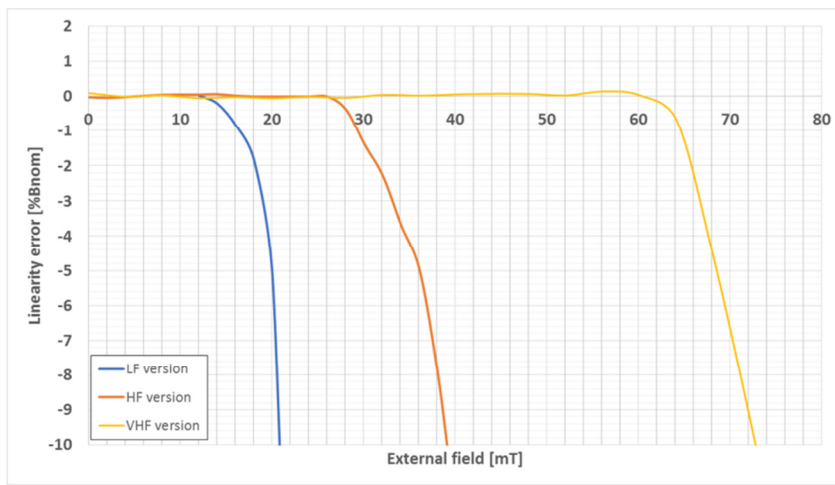

Figure 11: Linearity error for all versions.

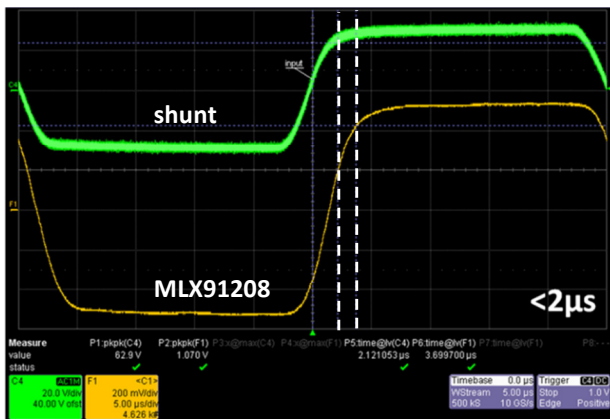

Figure 12: Response time with noise filter OFF.

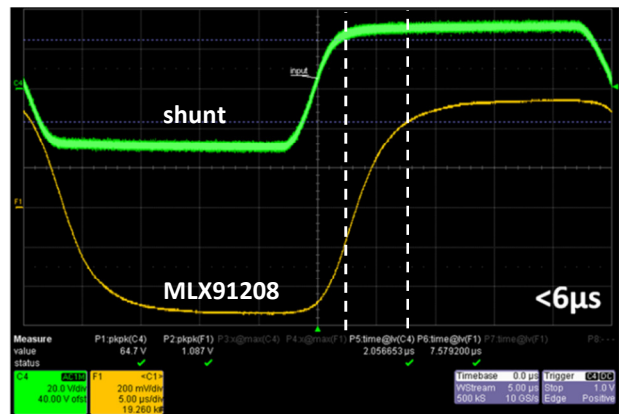

Figure 13: Response time with noise filter ON.

## 16. Standard information regarding manufacturability of Melexis products with different soldering processes

Melexis devices are qualified using state-of-the-art practices in accordance with automotive and environmental requirements.

Through qualifications, various soldering techniques are considered; please refer to “Soldering recommendations for Melexis products” for more information:

[http://www.melexis.com/Asset/Soldering\\_Application\\_Note\\_and\\_Recommendations\\_DownloadLink\\_5446.aspx](http://www.melexis.com/Asset/Soldering_Application_Note_and_Recommendations_DownloadLink_5446.aspx).

For components normally soldered using Surface Mounted Device techniques (eg: Reflow process), Melexis has defined and qualified Moisture Sensitivity Level and Peak Temperature in accordance with the Jecdec J-STD-020 standard. Delivered material is conditioned accordingly. Moisture Sensitivity Level and Peak Temperature information can be found on the label identifying the material.

In case you intend to use a reflow soldering process for through hole devices (Melexis’ package codes: SA, UA, VA, VK, VM), please contact Melexis to verify your soldering process compatibility.

The application of Wave Soldering for SMD’s is allowed only after consulting Melexis regarding assurance of adhesive strength between device and board.

Based on Melexis commitment to environmental responsibility, Europe legislations (Direction on the Restriction of the Use of Certain Hazardous substances, RoHS) and customer requests, Melexis has deployed Pb free leadfinish (typically Matte Tin) on all ASSP products.

For through hole devices (Melexis’ package codes: SA, UA, VA, VK, VM) Trim&Form, please refer to “Trim & Form recommendations for Melexis products” for more information:

[http://www.melexis.com/Assets/Trim\\_and\\_form\\_recommendations\\_DownloadLink\\_5565.aspx](http://www.melexis.com/Assets/Trim_and_form_recommendations_DownloadLink_5565.aspx)

## 17. ESD Precautions

Electronic semiconductor products are sensitive to Electro Static Discharge (ESD).

Always observe Electro Static Discharge control procedures whenever handling semiconductor products.

ESD HBM robustness is 2kV on external pins according to AEC-Q100-002 REV-D.



## 18. Package information

### 18.1. SOIC-8 Package Dimensions

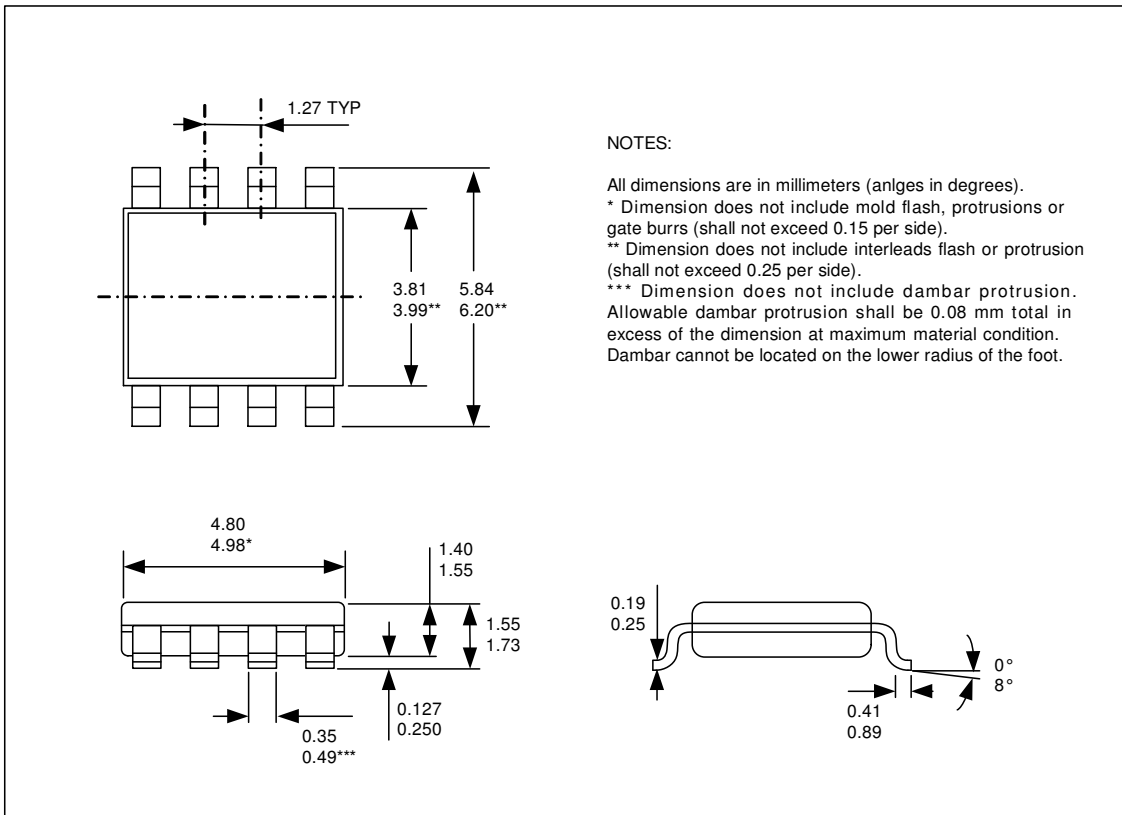

Figure 14: SOIC-8 Package dimensions

### 18.2. SOIC-8 Pinout and Marking

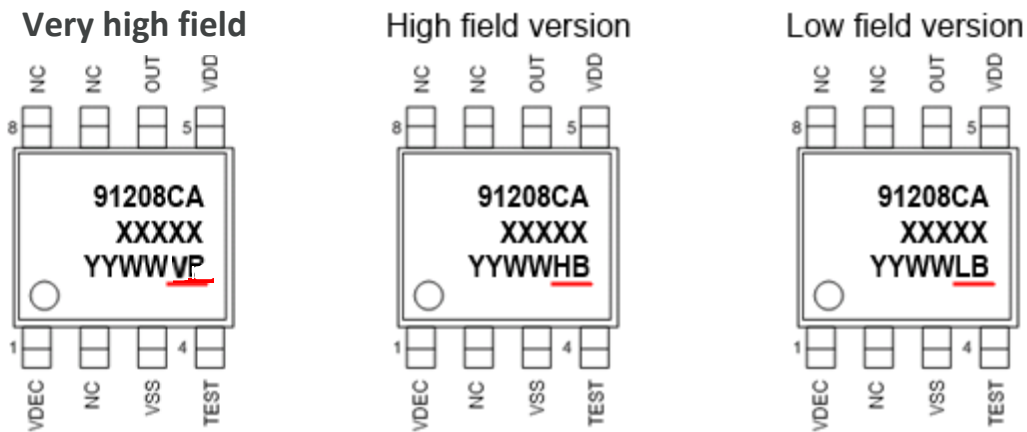

Figure 15: SOIC-8 Pinout and marking (Very High Field, High Field and Low Field version)

### 18.3. SOIC-8 Hall plate position

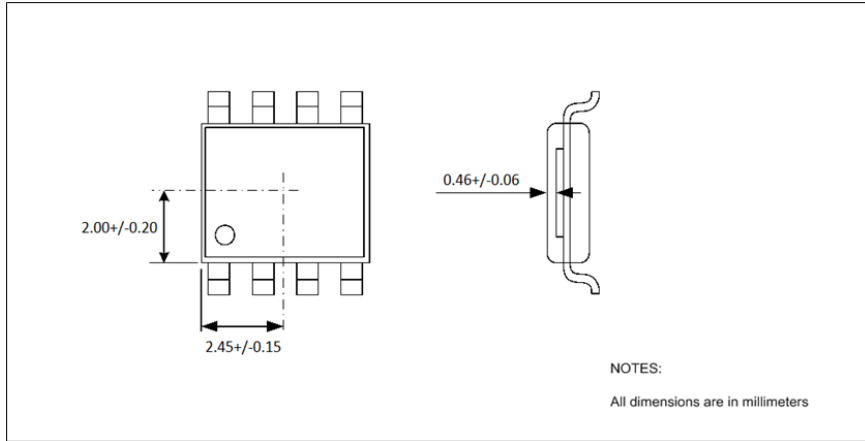

Figure 16: SOIC-8 Hall Plate positioning

18.4. SOIC-8 IMC Position and magnetic sensitive direction

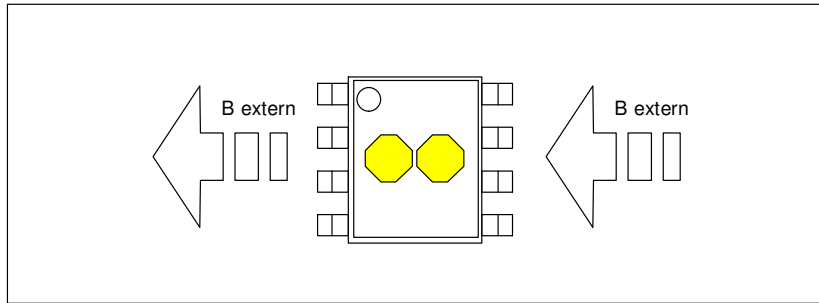

Figure 17: IMC position and geometry for low-field version

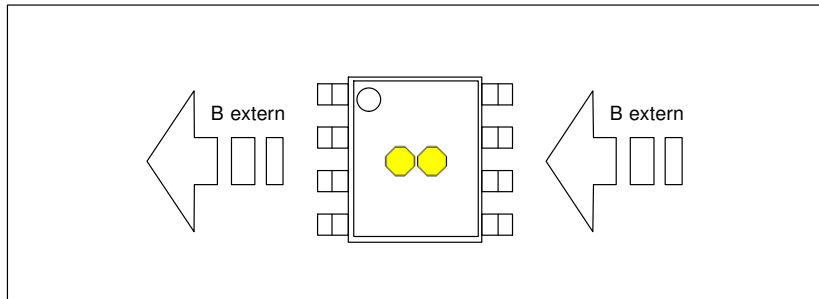

Figure 18: IMC position and geometry high-field version

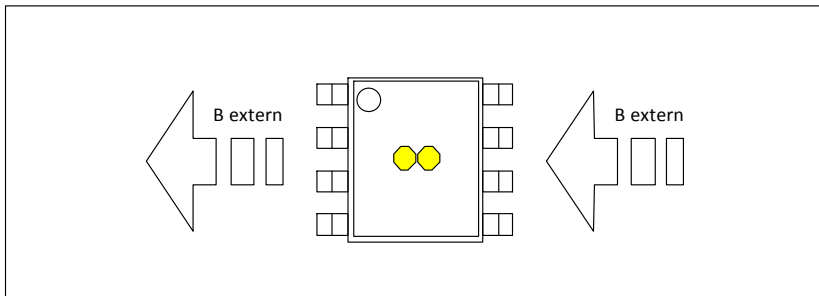

Figure 19: IMC position and geometry very high-field version

## 19. Disclaimer

*Devices sold by Melexis are covered by the warranty and patent indemnification provisions appearing in its Term of Sale. Melexis makes no warranty, express, statutory, implied, or by description regarding the information set forth herein or regarding the freedom of the described devices from patent infringement. Melexis reserves the right to change specifications and prices at any time and without notice. Therefore, prior to designing this product into a system, it is necessary to check with Melexis for current information. This product is intended for use in normal commercial applications. Applications requiring extended temperature range, unusual environmental requirements, or high reliability applications, such as military, medical life-support or life-sustaining equipment are specifically not recommended without additional processing by Melexis for each application.*

*The information furnished by Melexis is believed to be correct and accurate. However, Melexis shall not be liable to recipient or any third party for any damages, including but not limited to personal injury, property damage, loss of profits, loss of use, interrupt of business or indirect, special incidental or consequential damages, of any kind, in connection with or arising out of the furnishing, performance or use of the technical data herein. No obligation or liability to recipient or any third party shall arise or flow out of Melexis' rendering of technical or other services.*

*© 2016 Melexis NV. All rights reserved.*

For the latest version of this document, go to our website at  
**[www.melexis.com](http://www.melexis.com)**

Or for additional information contact Melexis Direct:

Europe, Africa, Asia:

Phone: +32 1367 0495

E-mail: [sales\\_europe@melexis.com](mailto:sales_europe@melexis.com)

America:

Phone: +1 603 223 2362

E-mail: [sales\\_usa@melexis.com](mailto:sales_usa@melexis.com)

ISO/TS 16949 and ISO14001 Certified

# HISTORY<sup>5</sup>

Rev. Nb.	Date	Name	Changes from Previous version
001	07-Jun-2014		Creation
002	10-Jul-2014		Incorrect MSL level, 1 => 3
004	22-Dec-2016		Migration to New template
005	13-Jul-2017		Formatting ® using existing from previous templates Formatting table and figure caption Added revision history Formatting 18.4. SOIC-8 IMC Position and magnetic sensitive changed figure 15 there is a rectangle text that is badly placed Using body formatting for non-header, caption Corrected references “ Self-diagnostic, table 12” instead of 13 “application diagram in section 14” instead of 16
006	19-Jul-17		Bandwidth in chapter 1. Feature and Benefits modified to 250kHz Read proof and typo corrections Modified Chapter 11. Programmable Items – Table 12 : added column “Factory Setting”, Removed parameter CRC[15:0] (not programmable), added parameter PlatePol
007	9-Mar-18		Removed Pull-Down option for Diagnostic Low
007.01	3-Apr-18		Updated feature and benefits : “AEC-Q100 automotive qualified”

---

<sup>5</sup> Dummy footnote to get last page number