



## GaAs MMIC I/Q DOWNCONVERTER 7 - 9 GHz

### Typical Applications

The HMC567LC5 is ideal for:

- Point-to-Point and Point-to-Multi-Point Radio
- EW & ELINT

### Features

- Conversion Gain: 10 dB
- Image Rejection: 35 dB
- LO to RF Isolation: 54 dB
- Noise Figure: 2.5 dB
- Input IP3: +1.5 dBm
- 32 Lead 5x5mm SMT Package: 25mm<sup>2</sup>

### Functional Diagram

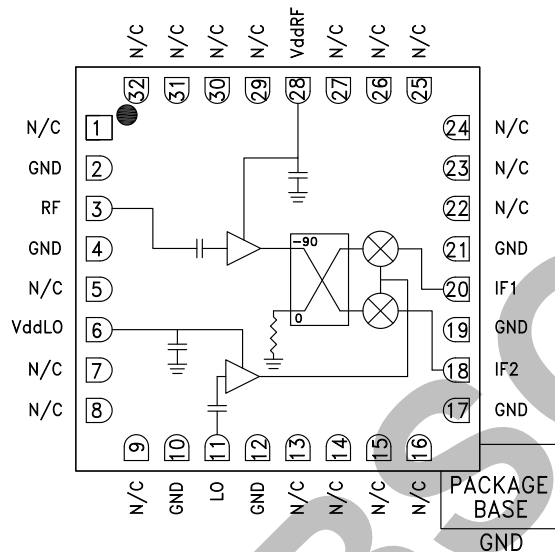

### General Description

The HMC567LC5 is a compact GaAs MCM I/Q downconverter in a leadless RoHS compliant SMT package. This device provides a small signal conversion gain of 10 dB with a noise figure of 2.5 dB and 35 dB of image rejection across the frequency band. The HMC567LC5 utilizes an LNA followed by an image reject mixer which is driven by an LO buffer amplifier. The image reject mixer eliminates the need for a filter following the LNA, and removes thermal noise at the image frequency. I and Q mixer outputs are provided and an external 90° hybrid is needed to select the required sideband. The HMC567LC5 is a much smaller alternative to hybrid style image reject mixer downconverter assemblies, and it eliminates the need for wire bonding by allowing the use of surface mount manufacturing techniques.

**Electrical Specifications,  $T_A = +25\text{ }^\circ\text{C}$ ,  
 $IF = 100\text{ MHz}$ ,  $LO = 0\text{ dBm}$ ,  $V_{ddLO} = 5.0\text{ Vdc}$ ,  $V_{ddRF} = 3.0\text{ Vdc}$ \***

Parameter	Min.	Typ.	Max.	Units
Frequency Range, RF		7 - 9		GHz
Frequency Range, LO		3.5 - 12.5		GHz
Frequency Range, IF		DC - 3.5		GHz
Conversion Gain (As IRM)	7	10		dB
Noise Figure		2.5		dB
Image Rejection	23	35		dB
1 dB Compression (Input)		-4		dBm
LO to RF Isolation	43	54		dB
LO to IF Isolation	20	32		dB
IP3 (Input)		+1.5		dBm
Amplitude Balance		±0.75		dB
Phase Balance		±3		Deg
Total Supply Current		160	195	mA

\*Data taken as IRM with external IF Hybrid



**GaAs MMIC I/Q DOWNCONVERTER  
7 - 9 GHz**

Data Taken As IRM With External IF Hybrid

**Conversion Gain vs. Temperature**

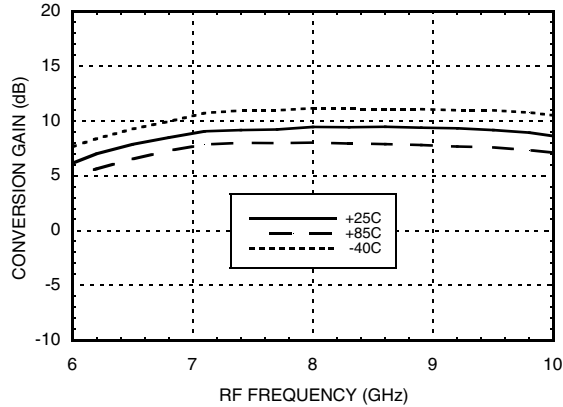

**Image Rejection vs. Temperature**

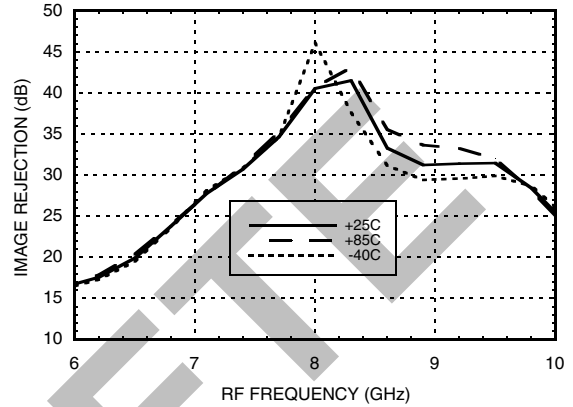

**Conversion Gain vs. LO Drive**

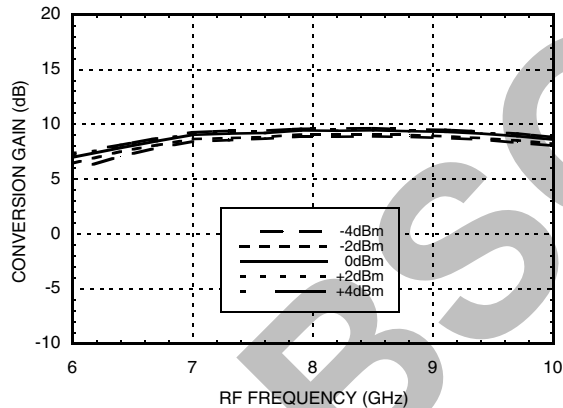

**Return Loss**

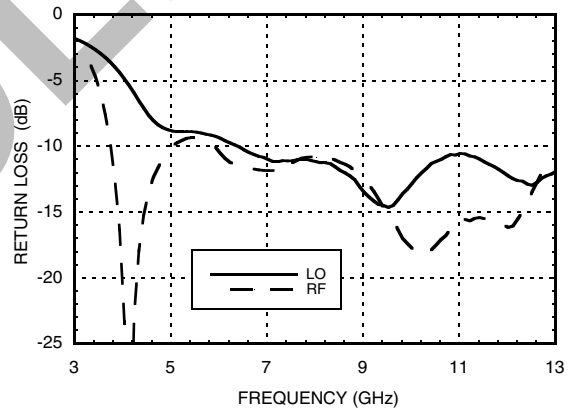

**Input P1dB vs. Temperature**

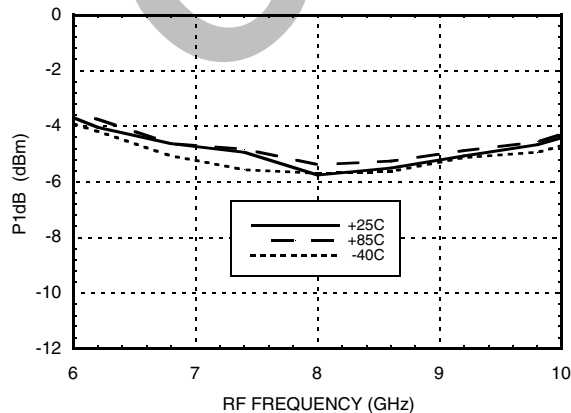

**Input IP3 vs. LO Drive**

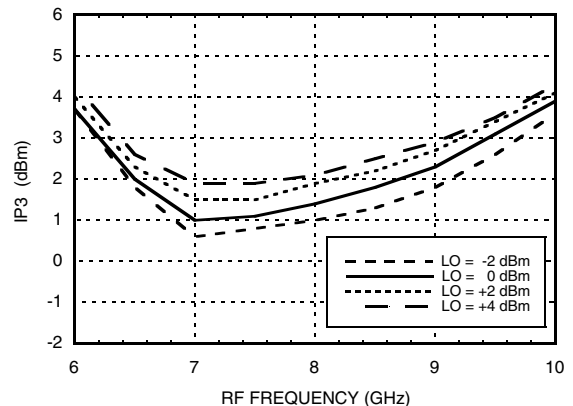

Information furnished by Analog Devices is believed to be accurate and reliable. However, no responsibility is assumed by Analog Devices for its use, nor for any infringements of patents or other rights of third parties that may result from its use. Specifications subject to change without notice. No license is granted by implication or otherwise under any patent or patent rights of Analog Devices. Trademarks and registered trademarks are the property of their respective owners.

For price, delivery, and to place orders: Analog Devices, Inc., One Technology Way, P.O. Box 9106, Norwood, MA 02062-9106 Phone: 781-329-4700 • Order online at [www.analog.com](http://www.analog.com) Application Support: Phone: 1-800-ANALOG-D



**GaAs MMIC I/Q DOWNCONVERTER  
7 - 9 GHz**

**Quadrature Channel Data Taken Without IF Hybrid**

**Isolations**

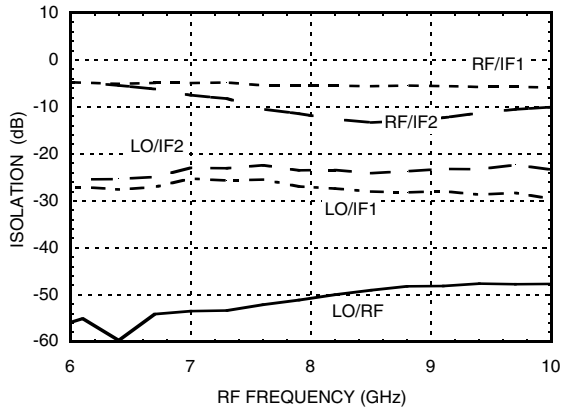

**IF Bandwidth\***

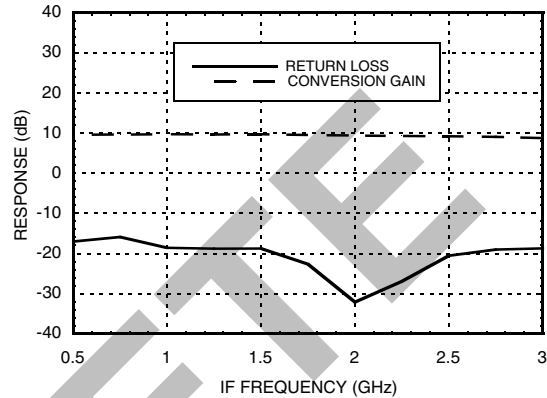

**Amplitude Balance vs. LO Drive**

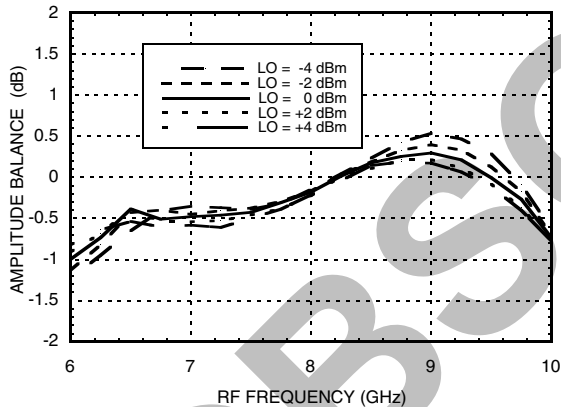

**Phase Balance vs. LO Drive**

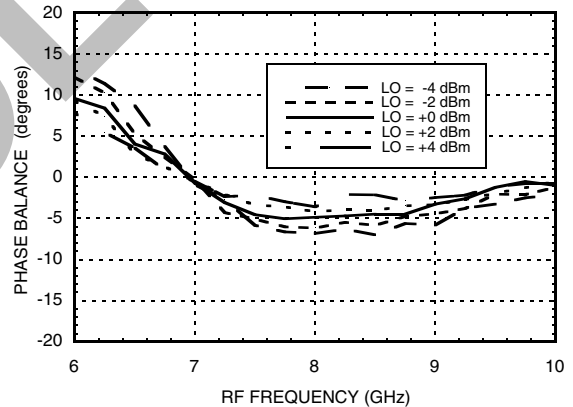

**Noise Figure vs. LO Drive,  
LO Frequency = 7.0 GHz**

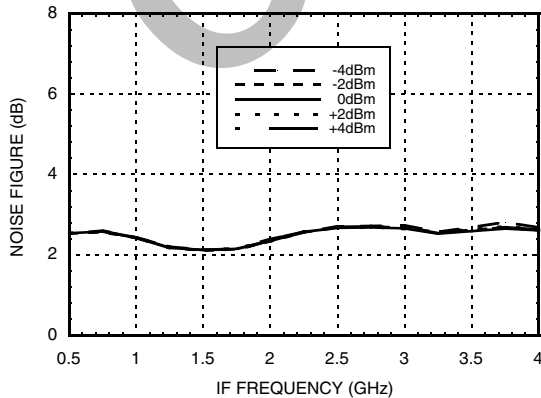

**Noise Figure vs. LO Drive,  
IF Frequency = 100 MHz**

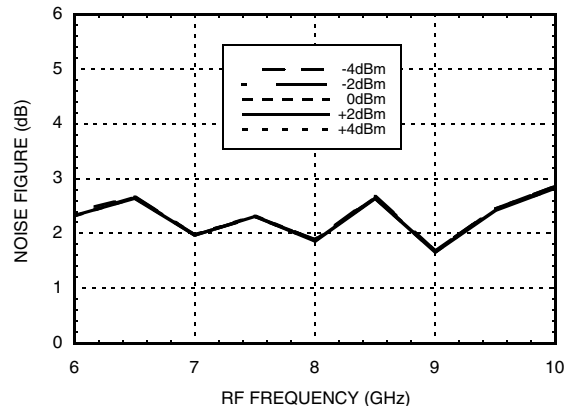

\* Conversion gain data taken with external IF hybrid, LO frequency fixed at 7.0 GHz and RF varied

**GaAs MMIC I/Q DOWNCONVERTER  
7 - 9 GHz**
**MxN Spurious Outputs**

mRF	nLO				
	0	1	2	3	4
0	xx	15	48	42	60
1	13	0	29	48	66
2	63	53	59	59	84
3	79	93	83	52	76
4	104	103	104	107	97

RF = 7.6 GHz @ -20 dBm

LO = 7.5 GHz @ +4 dBm

Data taken without IF hybrid

All values in dBc below IF power level.

**Absolute Maximum Ratings**

RF	+5 dBm
LO Drive	+20 dBm
VddRF / VddLO	4.0V / 5.5V
Channel Temperature	150°C
Continuous P <sub>diss</sub> (T=85°C) (derate 9.56 mW/°C above 85°C)	508 mW
Thermal Resistance (R <sub>TH</sub> ) (channel to package bottom)	77 °C/W
Storage Temperature	-65 to +150 °C
Operating Temperature	-55 to +85 °C



**ELECTROSTATIC SENSITIVE DEVICE  
OBSERVE HANDLING PRECAUTIONS**

OBSOLETE

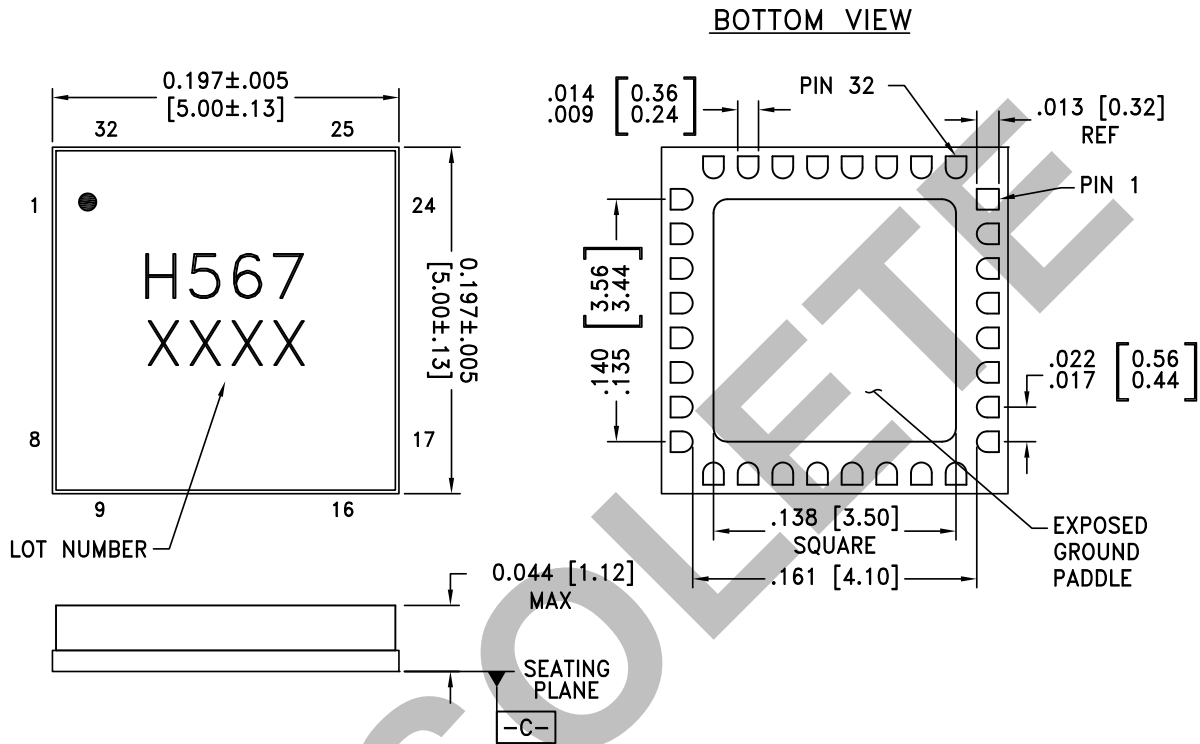

**GaAs MMIC I/Q DOWNCONVERTER**  
**7 - 9 GHz**

**Outline Drawing**



- NOTES:
1. PACKAGE BODY MATERIAL: ALUMINA
  2. LEAD AND GROUND PADDLE PLATING: 30 - 80 MICROINCHES GOLD OVER .50 MICROINCHES MINIMUM NICKLE
  3. DIMENSIONS ARE IN INCHES [MILLIMETERS]
  4. LEAD SPACING TOLERANCE IS NON-CUMULATIVE
  5. PACKAGE WARP SHALL NOT EXCEED 0.05mm DATUM
  6. ALL GROUND LEADS AND GROUND PADDLE MUST BE SOLDERED TO PCB RF GROUND

**Package Information**

Part Number	Package Body Material	Lead Finish	MSL Rating	Package Marking <sup>[2]</sup>
HMC567LC5	Alumina, White	Gold over Nickel	MSL3 <sup>[1]</sup>	H567 XXXX

[1] Max peak reflow temperature of 260 °C

[2] 4-Digit lot number XXXX



## GaAs MMIC I/Q DOWNCONVERTER 7 - 9 GHz

### Pin Descriptions

Pin Number	Function	Description	Interface Schematic
1, 5, 7 - 9, 13 - 16, 22 - 27, 29 - 32	N/C	No connection required. These pins may be connected to RF/DC ground without affecting performance.	
2, 4, 10, 12, 17, 19, 21	GND	These pins and ground paddle must be connected to RF/DC ground.	
3	RF	This pin is AC coupled and matched to 50 Ohms.	
6	VddLO	Power supply for LO amplifier. 100 mA typical, 120 mA maximum.	
28	VddRF	Power supply for RF LNA. 60 mA typical, 75 mA maximum.	
18	IF2	This pin is DC coupled for applications not requiring operation to DC. This port should be DC blocked externally using a series capacitor whose value has been chosen to pass the necessary frequency range. For operation to DC, this pin must not sink / source more than 3 mA of current or part non-function and possible failure will result.	
20	IF1		
11	LO	This pin is AC coupled and matched to 50 Ohms.	

### Typical Application

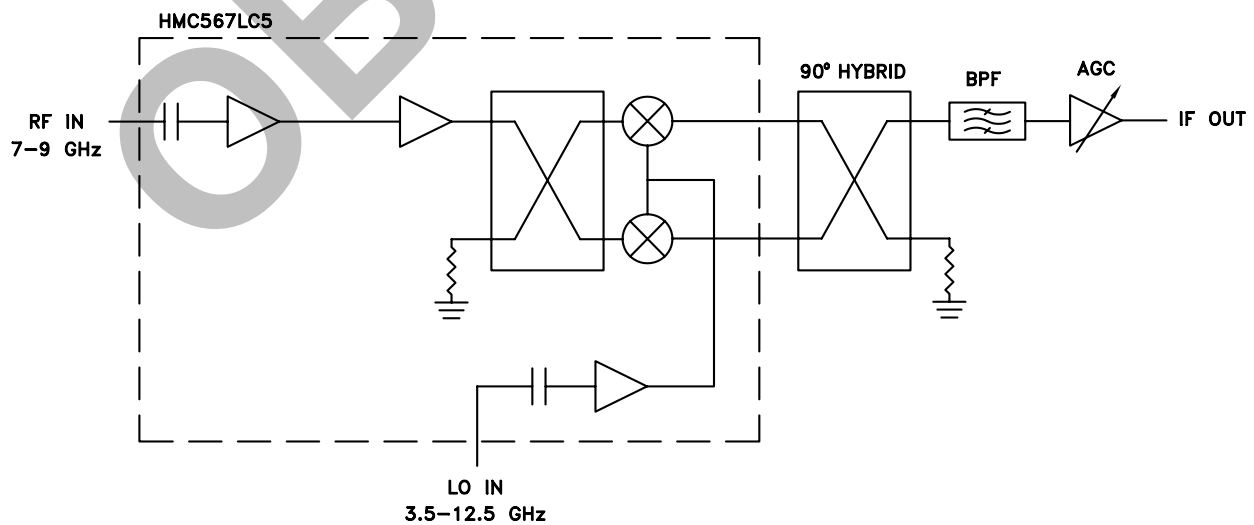

Note: LSB and USB is determined by GND on Hybrid



**GaAs MMIC I/Q DOWNCONVERTER  
7 - 9 GHz**

**Evaluation PCB**

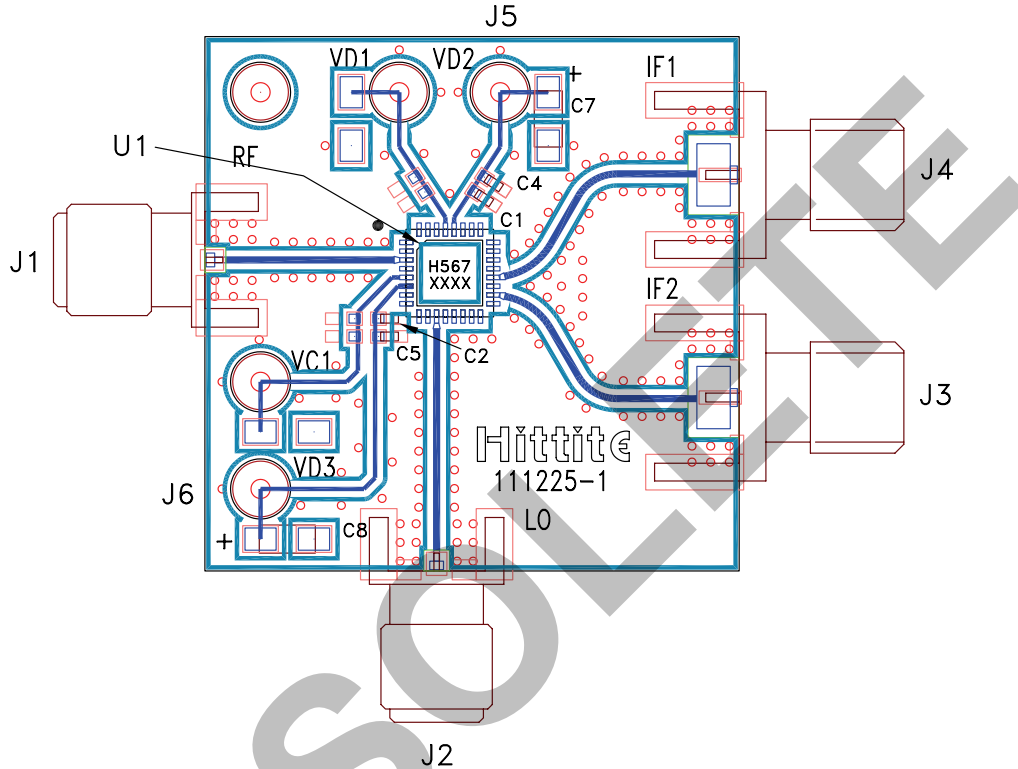

**List of Materials for Evaluation PCB 111239 [1]**

Item	Description
C1, C2	Capacitor 0402, Pkg. 100pF
C4, C5	Capacitor 0402, Pkg. 1000pF
C7, C8	Capacitor, Case A, 2.2uF *(Polarity)
J1, J2	PCB Mount SMA RF Connector, SRI
J3, J4	PCB Mount SMA Connector, Johnson
J5	DC Pin, VD2 = VddRF
J6	DC Pin, VD3 = VddLO
VC1, VD1	N/C
U1	HMC567LC5
PCB [2]	111225 Evaluation Board

[1] Reference this number when ordering complete evaluation PCB

[2] Circuit Board Material: Rogers 4350

The circuit board used in the application should use RF circuit design techniques. Signal lines should have 50 Ohm impedance while the package ground leads and exposed paddle should be connected directly to the ground plane similar to that shown. A sufficient number of via holes should be used to connect the top and bottom ground planes. The evaluation circuit board shown is available from Hittite upon request.

**GaAs MMIC I/Q DOWNCONVERTER  
7 - 9 GHz**

OBSOLETE