

HLMP-40xx, HLMP-08xx

T-1 3/4, 2 mm x 5 mm Rectangular Bicolor LED Lamps

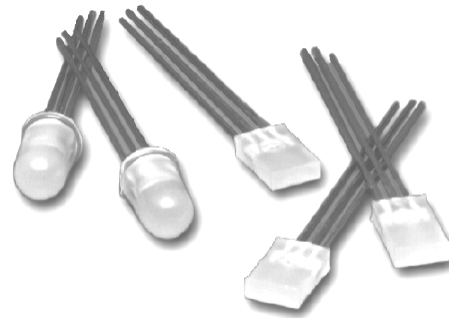

Data Sheet



Description

The T-1 3/4 HLMP-40xx and 2 mm by 5 mm rectangular HLMP-08xx are three leaded bicolor light sources designed for a variety of applications where dual state illumination is required in the same package. There are two LED chips, mounted on a central common cathode lead for maximum on-axis viewability. Colors between the two chips can be generated by independently pulse width modulating the LED chips.

Features

- Two color operation
- Three leads with one common cathode
- Option of straight or spread leads configuration

Selection Guide

Package	Part Number	Color	Package lens	Min. Luminous Intensity I _v (mcd)			I _F (mA)
				Green	Red	Yellow	
T-1 3/4	HLMP-4000	Green/HER	Non tinted, diffused	4.2	2.1		10
	HLMP-4000#xxx			4.2	2.1		10
	HLMP-4015	Green/Yellow	Non tinted, non-diffused	20.0		20	20
Rectangular	HLMP-0800	Green/HER	Non tinted, diffused	2.6	2.1		20
	HLMP-0805	Green/Yellow	Non tinted, diffused	2.6		1.4	20

Part Numbering System

HLMP - X X X X # X X X

Mechanical Options

- 002: Tape & Reel, Straight Leads
- 010: Right Angle Housing, Even Leads

Color Options

- 00: High Efficiency Red (HER)/High Efficiency Green
- 05/15: Yellow/High Efficiency Green

Package Options

- 40: T-1 3/4 (5 mm)
- 08: Rectangular

Package Dimensions

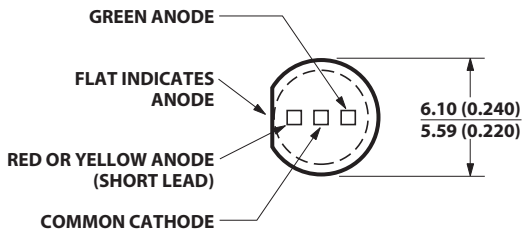
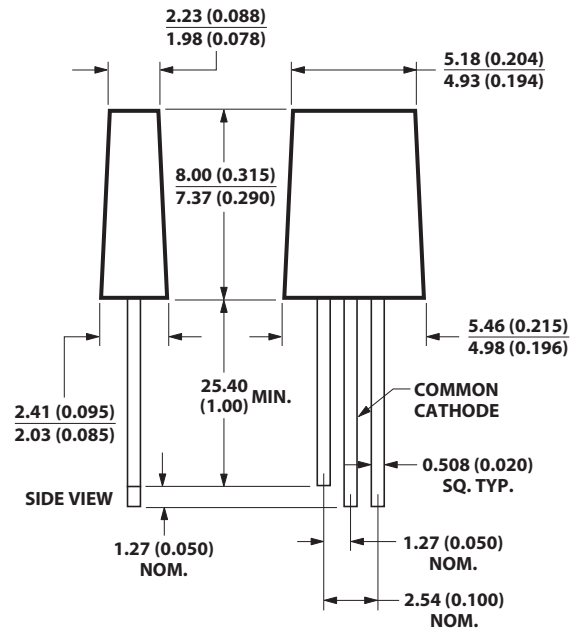
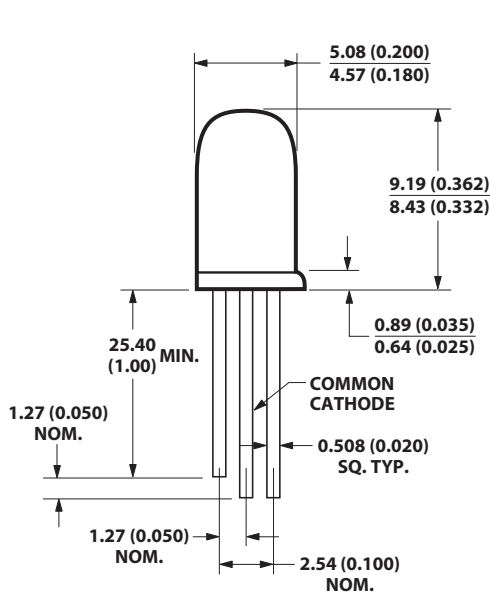

HLMP-40xx Straight Leads

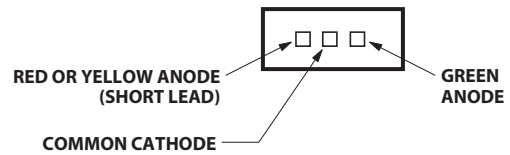

HLMP-08xx Straight Leads

Notes:

1. All dimensions are in millimeters (inches).
2. Epoxy meniscus may extend about 1 mm (0.040") down the leads.

Absolute Maximum Ratings at $T_A = 25^\circ\text{C}$

Parameter	HER/Green	Yellow/Green	Units
Peak Forward Current	90	60	mA
Average Forward Current ^[1,2] (Total)	25	20	mA
DC Current ^[2] (Total)	30	20	mA
Power Dissipation ^[3] (Total)	135	135	mW
Operating Temperature Range	-20 to +100	-20 to +100	°C
Storage Temperature Range	-40 to +100	-40 to +100	°C
Reverse Voltage ($I_R = 100 \mu\text{A}$)	5	5	V
Transient Forward Current ^[4] (10 μsec Pulse)	500	500	mA

Notes:

- See Figure 5 to establish pulsed operating conditions.
- The combined simultaneous current must not exceed the maximum.
- The combined simultaneous current must not exceed the maximum.
- The transient peak current is the maximum non-recurring current that can be applied to the device without damaging the LED die and wirebond. It is not recommended that the device be operated at peak currents beyond the peak forward current listed in the Absolute Maximum Ratings.

Electrical/Optical Characteristics at $T_A = 25^\circ\text{C}$

Symbol	Parameter	High Efficiency Red			Green			Yellow			Units	Test Condition
		Min.	Typ.	Max.	Min.	Typ.	Max.	Min.	Typ.	Max.		
λ_{PEAK}	Peak Wavelength		635			568			583		nm	20 mA
λ_d	Dominant Wavelength ^[1]		626			570			585		nm	20 mA
τ_s	Speed of Response		90			260			90		ns	
C	Capacitance		11			18			15		pF	$V_F = 0, f = 1 \text{ MHz}$
V_F	Forward Voltage		1.9	2.6		2.2	3.0	2.1	2.6		V	20 mA
V_R	Reverse Voltage	5			5			5			V	$I_R = 100 \mu\text{A}$
$R\theta_{\text{J-PIN}}$	Thermal Resistance		210			210			210		°C/W	Junction-to-Cathode Lead
$2\theta_{1/2}$	Included Angle between half luminous intensity points ^[2]											
	HLMP-40xx		65			65			65		de- gree	
	HLMP-08xx		100			100			100			
η_V	Luminous Efficacy ^[3]		145			595			500		lm/W	

Notes:

- The dominant wavelength, λ_d , is derived from the CIE Chromaticity Diagram and represents the single wavelength which defines the color of the device.
- $\theta_{1/2}$ is the off-axis angle at which the luminous intensity is half the axial luminous intensity.
- Radiant intensity, I_e , in watts steradian, may be found from the equation $I_e = I_v/\eta_V$, where I_v is the luminous intensity in candelas and η_V is the luminous efficacy in lumens/watt.

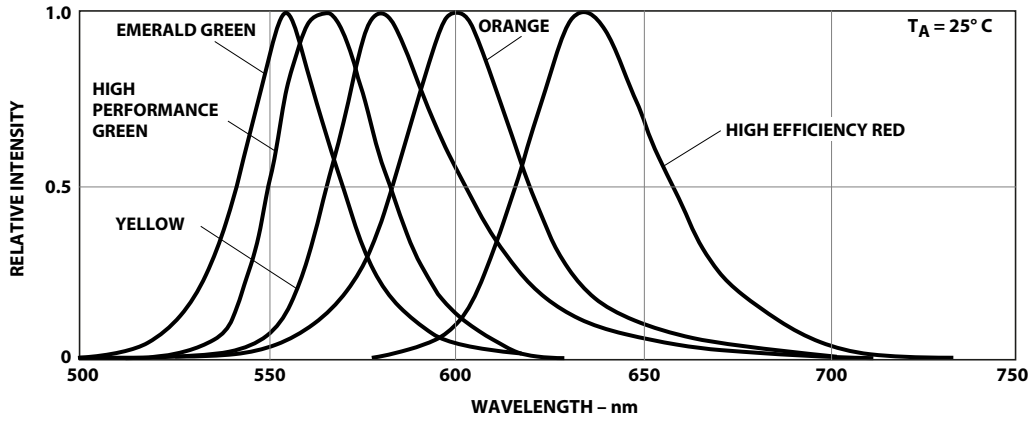

Figure 1. Relative intensity vs. wavelength.

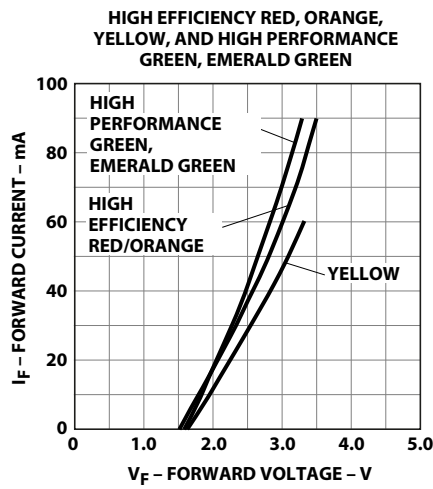

Figure 2. Forward current vs. forward voltage characteristics.

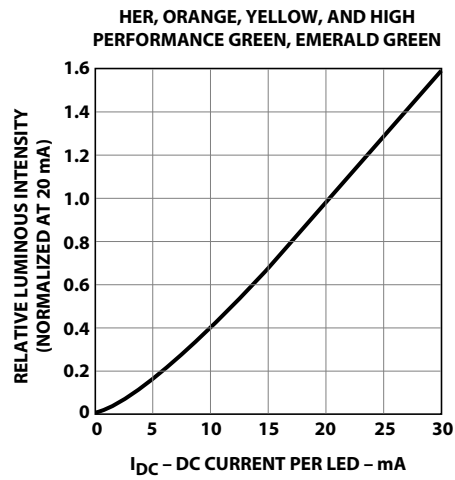

Figure 3. Relative luminous intensity vs. DC forward current.

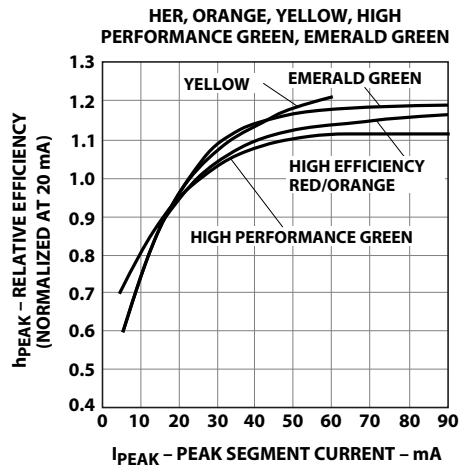

Figure 4. Relative efficiency (luminous intensity per unit current) vs. peak LED current.

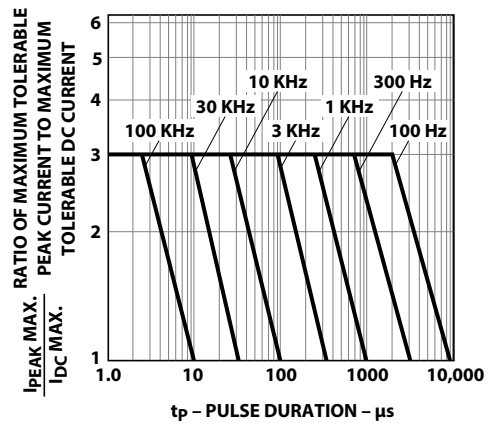

Figure 5. Maximum tolerable peak current vs. pulse duration. (I_{DC} Max. as per maximum ratings.)

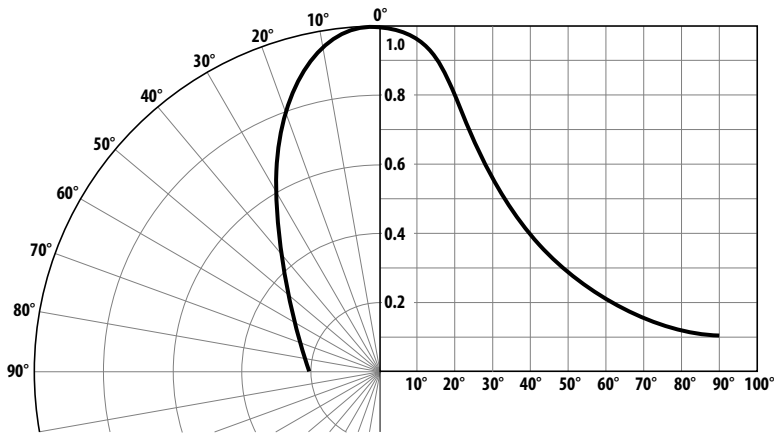

Figure 6. Relative luminous intensity vs. angular displacement for HLMP-40xx.

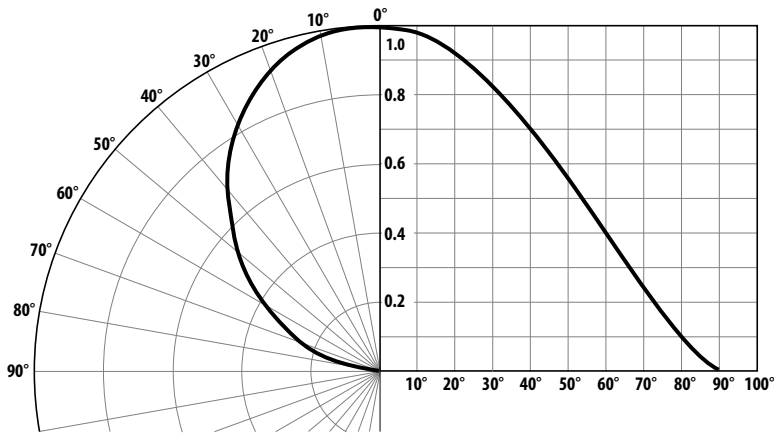

Figure 7. Relative luminous intensity vs. angular displacement for HLMP-08xx.

Mechanical Option Matrix

Mechanical Option Code	Definition
002	Tape & Reel, straight leads, minimum increment 1300 pcs/bag
010	Right Angle Housing, even leads, minimum increment 500 pcs/bag

Note:

All categories are established for classification of products. Products may not be available in all categories. Please contact your local Avago representative for further clarification/information.

Precautions:

Lead Forming

- The leads of an LED lamp may be preformed or cut to length prior to insertion and soldering into PC board.
- If lead forming is required before soldering, care must be taken to avoid any excessive mechanical stress induced to LED package. Otherwise, cut the leads of LED to length after soldering process at room temperature. The solder joint formed will absorb the mechanical stress of the lead cutting from traveling to the LED chip die attach and wirebond.
- It is recommended that tooling made to precisely form and cut the leads to length rather than rely upon hand operation.

Soldering Conditions

- Care must be taken during PCB assembly and soldering process to prevent damage to LED component.
- The closest LED is allowed to solder on board is 1.59 mm below the body (encapsulant epoxy) for those parts without standoff.
- Recommended soldering conditions:

	Wave Soldering	Manual Solder Dipping
Pre-heat Temperature	105 °C Max.	–
Pre-heat Time	30 sec Max.	–
Peak Temperature	250 °C Max.	260 °C Max.
Dwell Time	3 sec Max.	5 sec Max.

- Wave soldering parameter must be set and maintained according to recommended temperature and dwell time in the solder wave. Customer is advised to periodically check on the soldering profile to ensure the soldering profile used is always conforming to recommended soldering condition.
- If necessary, use fixture to hold the LED component in proper orientation with respect to the PCB during soldering process.
- Proper handling is imperative to avoid excessive thermal stresses to LED components when heated. Therefore, the soldered PCB must be allowed to cool to room temperature, 25°C, before handling.
- Special attention must be given to board fabrication, solder masking, surface plating and lead holes size and component orientation to assure solderability.
- Recommended PC board plated through hole sizes for LED component leads:

LED Component Lead Size	Diagonal	Plated Through Hole Diameter
0.457 x 0.457 mm (0.018 x 0.018 inch)	0.646 mm (0.025 inch)	0.976 to 1.078 mm (0.038 to 0.042 inch)
0.508 x 0.508 mm (0.020 x 0.020 inch)	0.718 mm (0.028 inch)	1.049 to 1.150 mm (0.041 to 0.045 inch)

Note: Refer to application note AN1027 for more information on soldering LED components.

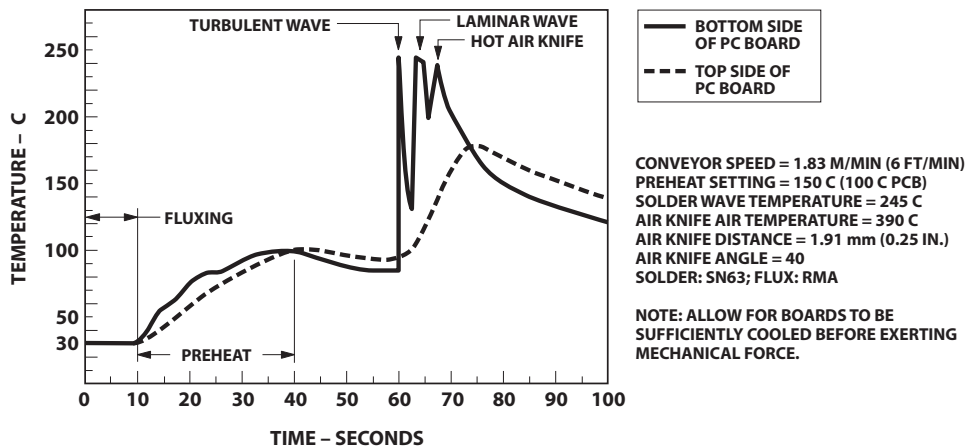

Figure 8. Recommended wave soldering profile.

For product information and a complete list of distributors, please go to our web site: www.avagotech.com

Mouser Electronics

Authorized Distributor

Click to View Pricing, Inventory, Delivery & Lifecycle Information:

[Broadcom Limited:](#)

[HLMP-0800](#) [HLMP-0805](#) [HLMP-4000](#) [HLMP-4000#002](#) [HLMP-4000#010](#) [HLMP-4015](#) [62097D2-002](#)