

TUHS3

TUH S 3 F 05

① ② ③ ④ ⑤

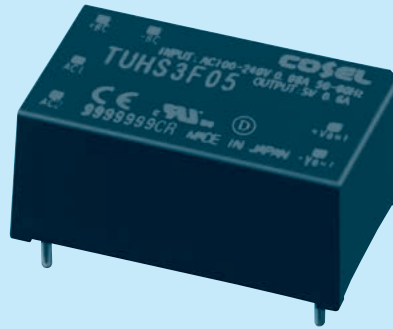

- ① Series name
- ② Single output
- ③ Output wattage
- ④ Universal Input
- ⑤ Output voltage

□ Class II

* Avoid short circuit between +BC and -BC. It may cause the failure of inside components.
 * To use TUHS, external components are required. Refer to the instruction manual for details.

MODEL	TUHS3F05	TUHS3F12	TUHS3F15	TUHS3F24
MAX OUTPUT WATTAGE[W]	3.00	3.00	3.00	3.12
DC OUTPUT	5V 0.6A	12V 0.25A	15V 0.2A	24V 0.13A

SPECIFICATIONS

	MODEL	TUHS3F05	TUHS3F12	TUHS3F15	TUHS3F24	
INPUT	VOLTAGE[V]	AC85 - 264 1 φ DC120 - 370				
	CURRENT[A]	ACIN 100V	0.08typ (Io=100%)			
		ACIN 200V	0.05typ (Io=100%)			
	FREQUENCY[Hz]	50/60 (47 - 63)				
	EFFICIENCY[%]	ACIN 100V	79typ	81typ	81typ	81typ
ACIN 200V		78typ	79typ	79typ	79typ	
INRUSH CURRENT	Limited by external components					
OUTPUT	VOLTAGE[V]	5	12	15	24	
	CURRENT[A]	0.6	0.25	0.2	0.13	
	LINE REGULATION[mV]	20max	48max	60max	96max	
	LOAD REGULATION[mV]	40max	100max	120max	150max	
	RIPPLE[mVp-p]	30 to 100% Load *1	120max	160max	160max	200max
		0 to 30% Load AC85V - 240V *1	400max	480max	480max	580max
	RIPPLE NOISE[mVp-p]	30 to 100% Load *1	160max	200max	200max	240max
		0 to 30% Load AC85V - 240V *1	480max	560max	560max	660max
	TEMPERATURE REGULATION[mV]	0 to +85°C	100max	180max	240max	360max
		-40 to +85°C	150max	270max	360max	480max
DRIFT[mV]	*2	20max	48max	60max	96max	
OUTPUT VOLTAGE SETTING[V]		4.90 - 5.30	11.40 - 12.60	14.25 - 15.75	23.00 - 25.00	
PROTECTION CIRCUIT AND OTHERS	OVERCURRENT PROTECTION	Works over 105% of rating and recover automatically				
	OVERVOLTAGE PROTECTION[V]	5.50 - 8.00	13.20 - 19.20	16.50 - 24.00	26.40 - 38.40	
ISOLATION	INPUT-OUTPUT	AC3,000V 1minute, Cutoff current = 10mA, DC500V 50MΩ min (20±15°C)				
ENVIRONMENT	OPERATING TEMP., HUMID. AND ALTITUDE	-40 to +85°C, 20 - 95%RH (Non condensing) (Refer to DERATING CURVE), 3,000m (10,000 feet) max				
	STORAGE TEMP., HUMID. AND ALTITUDE	-40 to +100°C, 20 - 95%RH (Non condensing), 9,000m (30,000 feet) max				
	VIBRATION	10 - 55Hz, 49.0m/s ² (5G), 3minutes period, 60minutes each along X, Y and Z axis				
	IMPACT	196.1m/s ² (20G), 11ms, once each along X, Y and Z axis				
SAFETY AND NOISE REGULATIONS	AGENCY APPROVALS	UL60950-1, C-UL (CSA60950-1), EN60950-1				
	CONDUCTED NOISE	Complies with FCC-B, VCCI-B, CISPR-B, EN55022-B *3				
	HARMONIC ATTENUATOR	Complies with IEC61000-3-2 (Class A) (Not built-in to active filter)				
OTHERS	CASE SIZE/WEIGHT	28.7 X 12.7 X 17.5mm[1.13 X 0.50 X 0.69 inches] (W X H X D) / 15g max				
	COOLING METHOD	Convection / Forced air				

*1 Refer to instruction manual for measuring method of electric characteristics.
 *2 Drift is the change in DC output for an eight hour period after a half-hour warm-up at 25°C, with the input voltage held constant at the rated value.
 *3 Do not ground secondly circuit, in case of a standard adapted.
 * Measured with 18μF capacitor as Cbc.

External view

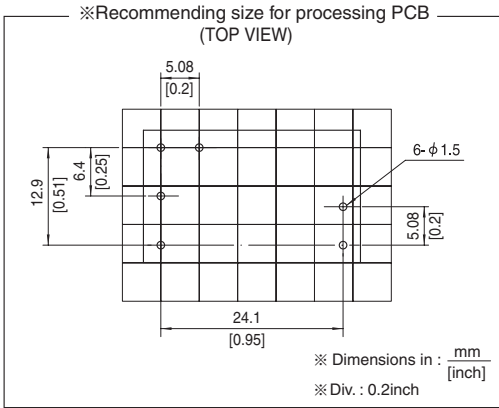
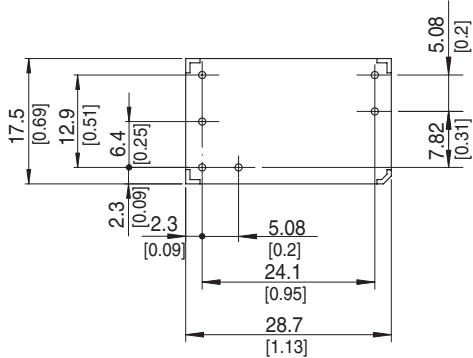
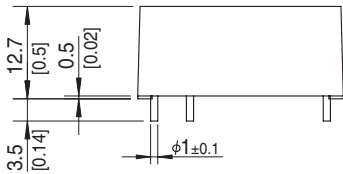
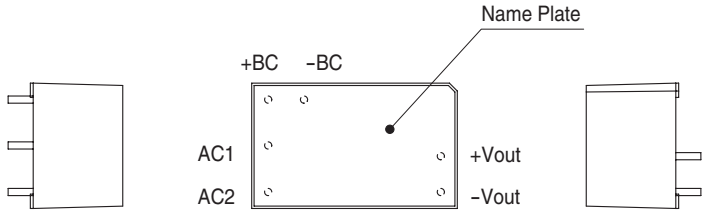

- ※ Tolerance : ± 0.5 [± 0.02]
- ※ Weight : 15g max
- ※ Case material : PBT
- ※ Pin material : Copper
- ※ Plating treatment of pin : Lead free plating
- ※ Dimensions in mm, []=inches

TUHS5

TUH S 5 F 05

① ② ③ ④ ⑤

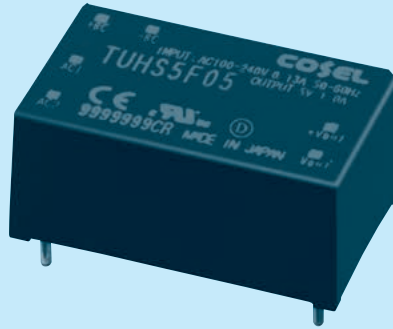

- ① Series name
- ② Single output
- ③ Output wattage
- ④ Universal Input
- ⑤ Output voltage

□ Class II

* Avoid short circuit between +BC and -BC. It may cause the failure of inside components.
 * To use TUHS, external components are required. Refer to the instruction manual for details.

MODEL	TUHS5F05	TUHS5F12	TUHS5F15	TUHS5F24
MAX OUTPUT WATTAGE[W]	5.00	5.40	5.10	5.28
DC OUTPUT	5V 1A	12V 0.45A	15V 0.34A	24V 0.22A

SPECIFICATIONS

	MODEL	TUHS5F05	TUHS5F12	TUHS5F15	TUHS5F24	
INPUT	VOLTAGE[V]	AC85 - 264 1 φ DC120 - 370				
	CURRENT[A]	ACIN 100V	0.13typ (Io=100%)			
		ACIN 200V	0.08typ (Io=100%)			
	FREQUENCY[Hz]	50/60 (47 - 63)				
	EFFICIENCY[%]	ACIN 100V	78typ	82typ	82typ	83typ
		ACIN 200V	79typ	82typ	82typ	83typ
INRUSH CURRENT	Limited by external components					
OUTPUT	VOLTAGE[V]	5	12	15	24	
	CURRENT[A]	1	0.45	0.34	0.22	
	LINE REGULATION[mV]	20max	48max	60max	96max	
	LOAD REGULATION[mV]	40max	100max	120max	150max	
	RIPPLE[mVp-p]	30 to 100% Load *1	120max	160max	160max	200max
		0 to 30% Load AC85V - 240V *1	400max	480max	480max	580max
	RIPPLE NOISE[mVp-p]	30 to 100% Load *1	160max	200max	200max	240max
		0 to 30% Load AC85V - 240V *1	480max	560max	560max	660max
	TEMPERATURE REGULATION[mV]	0 to +80°C	100max	180max	240max	360max
		-40 to +80°C	150max	270max	360max	480max
DRIFT[mV]	*2	20max	48max	60max	96max	
OUTPUT VOLTAGE SETTING[V]		4.90 - 5.30	11.40 - 12.60	14.25 - 15.75	23.00 - 25.00	
PROTECTION CIRCUIT AND OTHERS	OVERCURRENT PROTECTION	Works over 105% of rating and recover automatically				
	OVERVOLTAGE PROTECTION[V]	5.50 - 8.00	13.20 - 19.20	16.50 - 24.00	26.40 - 38.40	
ISOLATION	INPUT-OUTPUT	AC3,000V 1minute, Cutoff current = 10mA, DC500V 50MΩ min (20±15°C)				
ENVIRONMENT	OPERATING TEMP., HUMID. AND ALTITUDE	-40 to +85°C, 20 - 95%RH (Non condensing) (Refer to DERATING CURVE), 3,000m (10,000 feet) max				
	STORAGE TEMP., HUMID. AND ALTITUDE	-40 to +100°C, 20 - 95%RH (Non condensing), 9,000m (30,000 feet) max				
	VIBRATION	10 - 55Hz, 49.0m/s ² (5G), 3minutes period, 60minutes each along X, Y and Z axis				
	IMPACT	196.1m/s ² (20G), 11ms, once each along X, Y and Z axis				
SAFETY AND NOISE REGULATIONS	AGENCY APPROVALS	UL60950-1, C-UL (CSA60950-1), EN60950-1				
	CONDUCTED NOISE	Complies with FCC-B, VCCI-B, CISPR-B, EN55022-B *3				
	HARMONIC ATTENUATOR	Complies with IEC61000-3-2 (Class A) (Not built-in to active filter)				
OTHERS	CASE SIZE/WEIGHT	28.7 X 12.7 X 17.5mm[1.13 X 0.50 X 0.69 inches] (W X H X D) / 15g max				
	COOLING METHOD	Convection / Forced air				

*1 Refer to instruction manual for measuring method of electric characteristics.
 *2 Drift is the change in DC output for an eight hour period after a half-hour warm-up at 25°C, with the input voltage held constant at the rated value.
 *3 Do not ground secondly circuit, in case of a standard adapted.
 * Measured with 22μF capacitor as Cbc.

External view

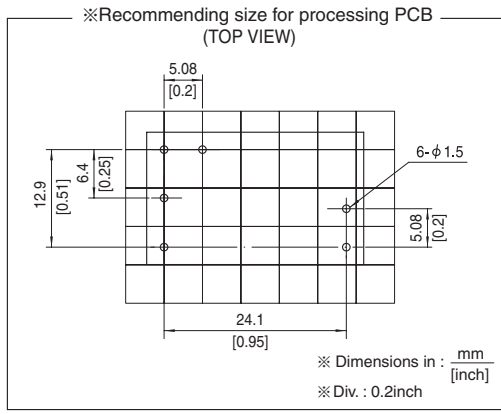
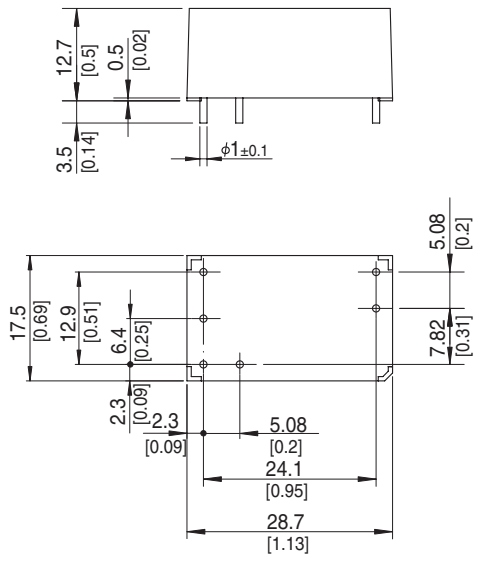
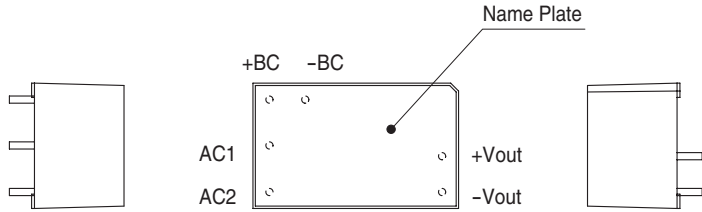

- ※ Tolerance : ± 0.5 [± 0.02]
- ※ Weight : 15g max
- ※ Case material : PBT
- ※ Pin material : Copper
- ※ Plating treatment of pin : Lead free plating
- ※ Dimensions in mm, []=inches

TUHS10

TUH S 10 F 05

① ② ③ ④ ⑤

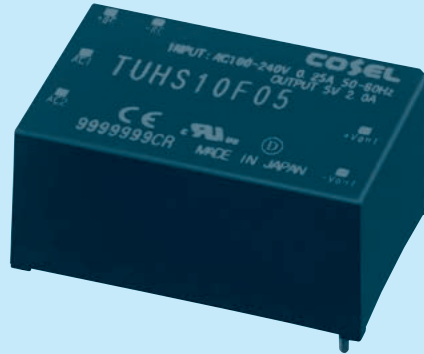

- ① Series name
- ② Single output
- ③ Output wattage
- ④ Universal Input
- ⑤ Output voltage

□ Class II

* Avoid short circuit between +BC and -BC. It may cause the failure of inside components.
 * To use TUHS, external components are required. Refer to the instruction manual for details.

MODEL	TUHS10F05	TUHS10F12	TUHS10F15	TUHS10F24
MAX OUTPUT WATTAGE[W]	10.00	10.80	10.10	10.80
DC OUTPUT	5V 2A	12V 0.9A	15V 0.67A	24V 0.45A

SPECIFICATIONS

	MODEL	TUHS10F05	TUHS10F12	TUHS10F15	TUHS10F24	
INPUT	VOLTAGE[V]	AC85 - 264 1 φ DC120 - 370				
	CURRENT[A]	ACIN 100V	0.25typ (Io=100%)			
		ACIN 200V	0.14typ (Io=100%)			
	FREQUENCY[Hz]	50/60 (47 - 63)				
	EFFICIENCY[%]	ACIN 100V	81typ	85typ	85typ	86typ
		ACIN 200V	82typ	85typ	85typ	87typ
INRUSH CURRENT	Limited by external components					
OUTPUT	VOLTAGE[V]	5	12	15	24	
	CURRENT[A]	2	0.9	0.67	0.45	
	LINE REGULATION[mV]	20max	48max	60max	96max	
	LOAD REGULATION[mV]	40max	100max	120max	150max	
	RIPPLE[mVp-p]	30 to 100% Load *1	120max	160max	160max	200max
		0 to 30% Load AC85V - 240V *1	400max	480max	480max	580max
	RIPPLE NOISE[mVp-p]	30 to 100% Load *1	160max	200max	200max	240max
		0 to 30% Load AC85V - 240V *1	480max	560max	560max	660max
	TEMPERATURE REGULATION[mV]	0 to +70°C	100max	180max	240max	360max
		-40 to +70°C	150max	270max	360max	480max
DRIFT[mV]	*2	20max	48max	60max	96max	
OUTPUT VOLTAGE SETTING[V]		4.90 - 5.30	11.40 - 12.60	14.25 - 15.75	23.00 - 25.00	
PROTECTION CIRCUIT AND OTHERS	OVERCURRENT PROTECTION	Works over 105% of rating and recover automatically				
	OVERVOLTAGE PROTECTION[V]	5.50 - 8.00	13.20 - 19.20	16.50 - 24.00	26.40 - 38.40	
ISOLATION	INPUT-OUTPUT	AC3,000V 1minute, Cutoff current = 10mA, DC500V 50MΩ min (20±15°C)				
ENVIRONMENT	OPERATING TEMP., HUMID. AND ALTITUDE	-40 to +85°C, 20 - 95%RH (Non condensing) (Refer to DERATING CURVE), 3,000m (10,000 feet) max				
	STORAGE TEMP., HUMID. AND ALTITUDE	-40 to +100°C, 20 - 95%RH (Non condensing), 9,000m (30,000 feet) max				
	VIBRATION	10 - 55Hz, 49.0m/s ² (5G), 3minutes period, 60minutes each along X, Y and Z axis				
	IMPACT	196.1m/s ² (20G), 11ms, once each along X, Y and Z axis				
SAFETY AND NOISE REGULATIONS	AGENCY APPROVALS	UL60950-1, C-UL (CSA60950-1), EN60950-1				
	CONDUCTED NOISE	Complies with FCC-B, VCCI-B, CISPR-B, EN55022-B *3				
	HARMONIC ATTENUATOR	Complies with IEC61000-3-2 (Class A) (Not built-in to active filter)				
OTHERS	CASE SIZE/WEIGHT	33.0 X 15.0 X 22.0mm [1.3 X 0.59 X 0.86 inches] (W X H X D) / 25g max				
	COOLING METHOD	Convection / Forced air				

*1 Refer to instruction manual for measuring method of electric characteristics.
 *2 Drift is the change in DC output for an eight hour period after a half-hour warm-up at 25°C, with the input voltage held constant at the rated value.
 *3 Do not ground secondly circuit, in case of a standard adapted.
 * Measured with 47μF capacitor as Cbc.

External view

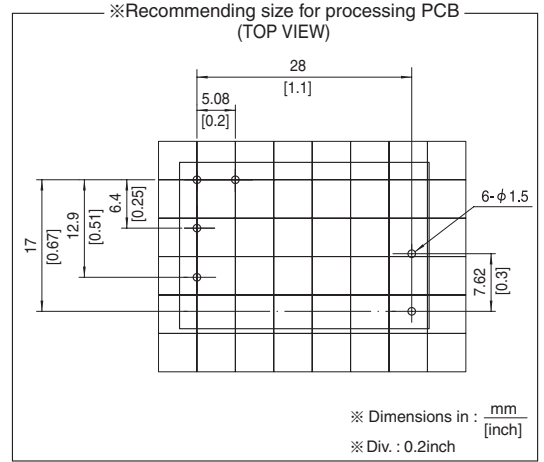
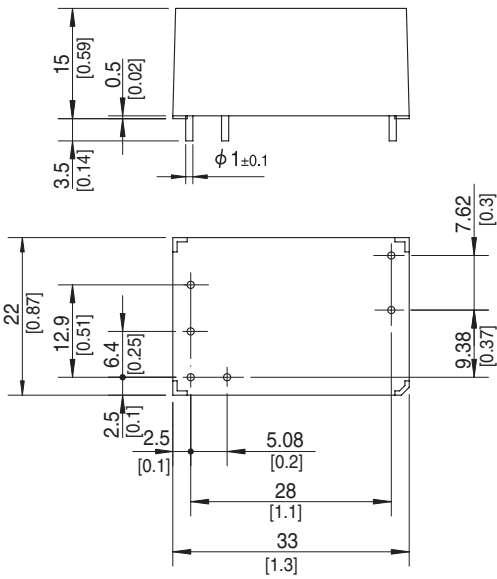
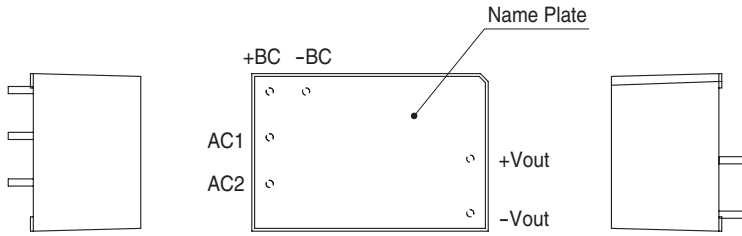

- ※ Tolerance : ± 0.5 [± 0.02]
- ※ Weight : 25g max
- ※ Case material : PBT
- ※ Pin material : Copper
- ※ Plating treatment of pin : Lead free plating
- ※ Dimensions in mm, []=inches

TUHS15

TUH S 15 F 12

① ② ③ ④ ⑤

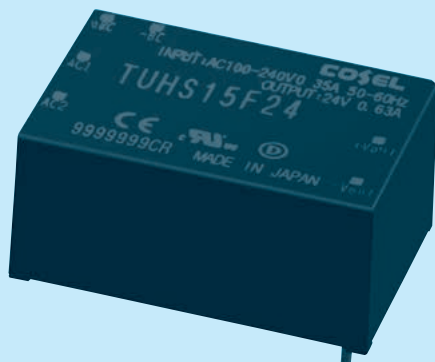

- ① Series name
- ② Single output
- ③ Output wattage
- ④ Universal Input
- ⑤ Output voltage

□ Class II

* Avoid short circuit between +BC and -BC. It may cause the failure of inside components.
 * To use TUHS, external components are required. Refer to the instruction manual for details.

MODEL	TUHS15F12	TUHS15F15	TUHS15F24
MAX OUTPUT WATTAGE[W]	15.00	15.00	15.12
DC OUTPUT	12V 1.25A	15V 1A	24V 0.63A

SPECIFICATIONS

	MODEL	TUHS15F12	TUHS15F15	TUHS15F24	
INPUT	VOLTAGE[V]	AC85 - 264 1 φ DC120 - 370			
	CURRENT[A]	ACIN 100V	0.35typ (Io=100%)		
		ACIN 200V	0.18typ (Io=100%)		
	FREQUENCY[Hz]	50/60 (47 - 63)			
	EFFICIENCY[%]	ACIN 100V	85typ	85typ	86typ
		ACIN 200V	85typ	85typ	87typ
INRUSH CURRENT	Limited by external components				
OUTPUT	VOLTAGE[V]	12	15	24	
	CURRENT[A]	1.25	1	0.63	
	LINE REGULATION[mV]	48max	60max	96max	
	LOAD REGULATION[mV]	100max	120max	150max	
	RIPPLE[mVp-p]	30 to 100% Load *1	160max	160max	200max
		0 to 30% Load AC85V - 240V *1	480max	480max	580max
	RIPPLE NOISE[mVp-p]	30 to 100% Load *1	200max	200max	240max
		0 to 30% Load AC85V - 240V *1	560max	560max	660max
	TEMPERATURE REGULATION[mV]	0 to +50°C	180max	240max	360max
		-40 to +50°C	270max	360max	480max
DRIFT[mV]	*2	48max	60max	96max	
OUTPUT VOLTAGE SETTING[V]	11.40 - 12.60	14.25 - 15.75	23.00 - 25.00		
PROTECTION CIRCUIT AND OTHERS	OVERCURRENT PROTECTION	Works over 105% of rating and recover automatically			
	OVERVOLTAGE PROTECTION[V]	13.20 - 19.20	16.50 - 24.00	26.40 - 38.40	
ISOLATION	INPUT-OUTPUT	AC3,000V 1minute, Cutoff current = 10mA, DC500V 50MΩ min (20±15°C)			
ENVIRONMENT	OPERATING TEMP., HUMID. AND ALTITUDE	-40 to +85°C, 20 - 95%RH (Non condensing) (Refer to DERATING CURVE), 3,000m (10,000 feet) max			
	STORAGE TEMP., HUMID. AND ALTITUDE	-40 to +100°C, 20 - 95%RH (Non condensing), 9,000m (30,000 feet) max			
	VIBRATION	10 - 55Hz, 49.0m/s ² (5G), 3minutes period, 60minutes each along X, Y and Z axis			
	IMPACT	196.1m/s ² (20G), 11ms, once each along X, Y and Z axis			
SAFETY AND NOISE REGULATIONS	AGENCY APPROVALS	UL60950-1, C-UL (CSA60950-1), EN60950-1			
	CONDUCTED NOISE	Complies with FCC-B, VCCI-B, CISPR-B, EN55022-B *3			
	HARMONIC ATTENUATOR	Complies with IEC61000-3-2 (Class A) (Not built-in to active filter)			
OTHERS	CASE SIZE/WEIGHT	33.0 × 15.0 × 22.0mm [1.3 × 0.59 × 0.86 inches] (W × H × D) / 25g max			
	COOLING METHOD	Convection / Forced air			

*1 Refer to instruction manual for measuring method of electric characteristics.
 *2 Drift is the change in DC output for an eight hour period after a half-hour warm-up at 25°C, with the input voltage held constant at the rated value.
 *3 Do not ground secondly circuit, in case of a standard adapted.
 * Measured with 68μF capacitor as Cbc.

External view

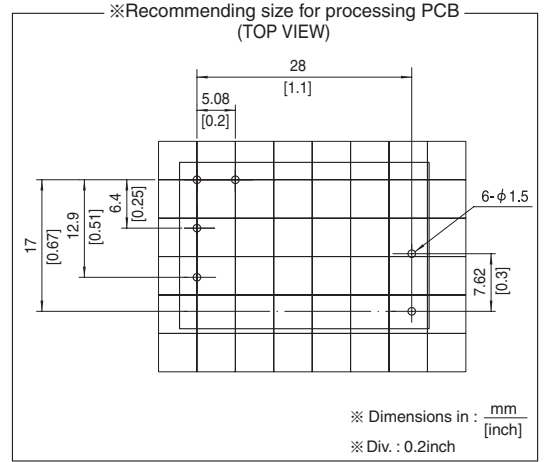
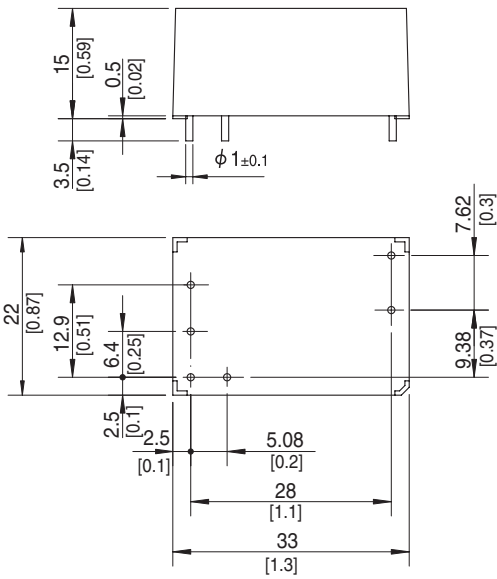
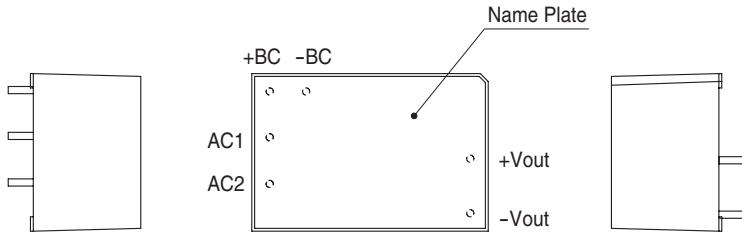

- ※ Dimensions in : $\frac{\text{mm}}{[\text{inch}]}$
- ※ Div. : 0.2inch
- ※ Tolerance : ± 0.5 [± 0.02]
- ※ Weight : 25g max
- ※ Case material : PBT
- ※ Pin material : Copper
- ※ Plating treatment of pin : Lead free plating
- ※ Dimensions in mm, []=inches

TUHS25

TUH S 25 F 05

① ② ③ ④ ⑤

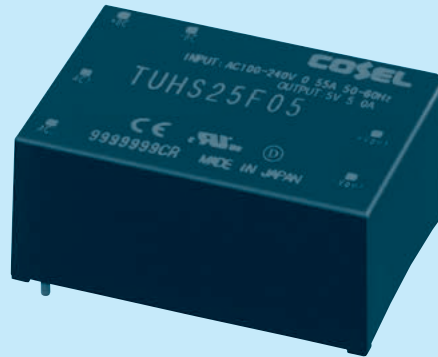

- ① Series name
- ② Single output
- ③ Output wattage
- ④ Universal Input
- ⑤ Output voltage

□ Class II

* Avoid short circuit between +BC and -BC. It may cause the failure of inside components.
 * To use TUHS, external components are required. Refer to the instruction manual for details.

MODEL	TUHS25F05	TUHS25F12	TUHS25F15	TUHS25F24
MAX OUTPUT WATTAGE[W]	25.00	25.20	25.50	26.40
DC OUTPUT	5V 5A	12V 2.1A	15V 1.7A	24V 1.1A

SPECIFICATIONS

	MODEL	TUHS25F05	TUHS25F12	TUHS25F15	TUHS25F24	
INPUT	VOLTAGE[V]	AC85 - 264 1 φ DC120 - 370				
	CURRENT[A]	ACIN 100V	0.55typ (Io=100%)			
		ACIN 200V	0.35typ (Io=100%)			
	FREQUENCY[Hz]	50/60 (47 - 63)				
	EFFICIENCY[%]	ACIN 100V	87typ	88typ	88typ	89typ
ACIN 200V		87typ	88typ	88typ	90typ	
INRUSH CURRENT		Limited by external components				
OUTPUT	VOLTAGE[V]	5	12	15	24	
	CURRENT[A]	5	2.1	1.7	1.1	
	LINE REGULATION[mV]	20max	48max	60max	96max	
	LOAD REGULATION[mV]	40max	100max	120max	150max	
	RIPPLE[mVp-p]	30 to 100% Load *1	120max	160max	160max	200max
		0 to 30% Load AC85V - 240V *1	400max	480max	480max	580max
	RIPPLE NOISE[mVp-p]	30 to 100% Load *1	160max	200max	200max	240max
		0 to 30% Load AC85V - 240V *1	480max	560max	560max	660max
	TEMPERATURE REGULATION[mV]	0 to +50°C	100max	180max	240max	360max
		-40 to +50°C	150max	270max	360max	480max
DRIFT[mV]	*2	20max	48max	60max	96max	
OUTPUT VOLTAGE SETTING[V]		4.90 - 5.30	11.40 - 12.60	14.25 - 15.75	23.00 - 25.00	
PROTECTION CIRCUIT AND OTHERS	OVERCURRENT PROTECTION	Works over 105% of rating and recover automatically				
	OVERVOLTAGE PROTECTION[V]	5.50 - 8.00	13.20 - 19.20	16.50 - 24.00	26.40 - 38.40	
ISOLATION	INPUT-OUTPUT	AC3,000V 1minute, Cutoff current = 10mA, DC500V 50MΩ min (20±15°C)				
ENVIRONMENT	OPERATING TEMP., HUMID. AND ALTITUDE	-40 to +85°C, 20 - 95%RH (Non condensing) (Refer to DERATING CURVE), 3,000m (10,000 feet) max				
	STORAGE TEMP., HUMID. AND ALTITUDE	-40 to +100°C, 20 - 95%RH (Non condensing), 9,000m (30,000 feet) max				
	VIBRATION	10 - 55Hz, 49.0m/s ² (5G), 3minutes period, 60minutes each along X, Y and Z axis				
	IMPACT	196.1m/s ² (20G), 11ms, once each along X, Y and Z axis				
SAFETY AND NOISE REGULATIONS	AGENCY APPROVALS	UL60950-1, C-UL (CSA60950-1), EN60950-1				
	CONDUCTED NOISE	Complies with FCC-B, VCCI-B, CISPR-B, EN55022-B *3				
	HARMONIC ATTENUATOR	Complies with IEC61000-3-2 (Class A) (Not built-in to active filter)				
OTHERS	CASE SIZE/WEIGHT	36.0 X 16.5 X 25.4mm [1.42 X 0.65 X 1.0 inches] (W X H X D) / 40g max				
	COOLING METHOD	Convection / Forced air				

*1 Refer to instruction manual for measuring method of electric characteristics.
 *2 Drift is the change in DC output for an eight hour period after a half-hour warm-up at 25°C, with the input voltage held constant at the rated value.
 *3 Do not ground secondly circuit, in case of a standard adapted.
 * Measured with 120μF capacitor as Cbc.

External view

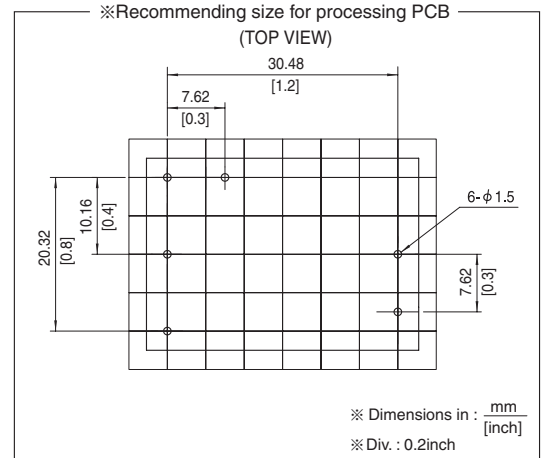
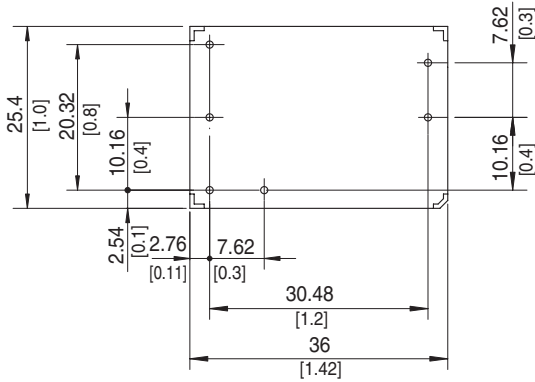
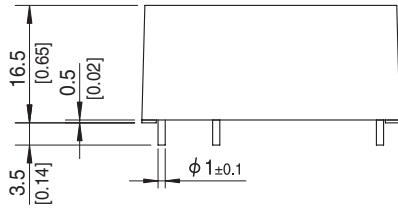
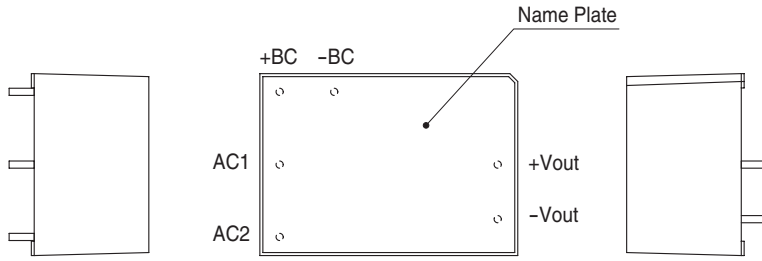

- ※ Tolerance : ± 0.5 [± 0.02]
- ※ Weight : 40g max
- ※ Case material : PBT
- ※ Pin material : Copper
- ※ Plating treatment of pin : Lead free plating
- ※ Dimensions in mm, []=inches

Mouser Electronics

Authorized Distributor

Click to View Pricing, Inventory, Delivery & Lifecycle Information:

Cosel:

[TUHS3F24](#) [TUHS5F24](#) [TUHS3F12](#) [TUHS25F24](#) [TUHS5F12](#) [TUHS10F24](#) [TUHS10F12](#) [TUHS10F05](#) [TUHS5F05](#)
[TUHS3F05](#) [TUHS25F12](#) [TUHS25F05](#) [TUHS15F24](#) [TUHS15F12](#)