

# 40x40x20 mm

San Ace 40 9P type   



## General Specifications

- Material ..... Frame: Plastic (Flammability: UL 94V-0), Impeller: Plastic (Flammability: UL 94V-1)
- Expected life ..... See the table below. (L10 life: 90% survival rate for continuous operation in free air at 60°C, rated voltage)
- Motor protection function ..... Locked rotor burnout protection, Reverse polarity protection  
For details, please refer to p. 529.
- Dielectric strength ..... 50/60 Hz, 500 VAC, for 1 minute (between lead wire conductors and frame)
- Insulation resistance ..... 10 MΩ or more with a 500 VDC megger (between lead wire conductors and frame)
- Sound pressure level (SPL) ..... At 1 m away from the air inlet
- Storage temperature ..... -30 to +70°C (Non-condensing)
- Lead wire ..... ⊕Red ⊖Black or Blue (Sensor) Yellow
- Mass ..... 45 g

## Specifications

The models listed below **have ribs and pulse sensors.**

Model no.	Rated voltage [V]	Operating voltage range [V]	Rated current [A]	Rated input [W]	Rated speed [min <sup>-1</sup> ]	Max. airflow [m <sup>3</sup> /min] [CFM]	Max. static pressure [Pa] [inchH <sub>2</sub> O]	SPL [dB (A)]	Operating temperature [°C]	Expected life [h]
<b>109P0405J601</b>	5	4.5 to 5.5	0.46	2.3	9800	0.28 9.9	98.5 0.396	39	-20 to +70	40000/60°C
<b>109P0405H601</b>			0.32	1.6	8000	0.225 8.0	65.7 0.264	33		
<b>109P0405F601</b>			0.25	1.25	6500	0.183 6.5	45.1 0.181	28		
<b>109P0405M601</b>			0.12	0.6	5000	0.136 4.8	26.5 0.106	24		
<b>109P0412G601</b>	12	7 to 13.8	0.28	3.36	12500	0.35 12.4	153.8 0.618	44	-20 to +60	40000/60°C
<b>109P0412D601</b>			0.18	2.16	11000	0.31 10.9	124 0.498	42		
<b>109P0412E601</b>			0.13	1.56	9200	0.26 9.2	87.3 0.351	37		
<b>109P0412H601</b>			0.11	1.32	8000	0.225 8.0	65.7 0.264	33		
<b>109P0412F601</b>			0.09	1.08	6500	0.183 6.5	45.1 0.181	28		
<b>109P0412M601</b>	8 to 13.8	0.06	0.72	5000	0.136 4.8	26.5 0.106	24			
<b>109P0424G601</b>	24	12 to 27.6	0.15	3.6	12500	0.35 12.4	153.8 0.618	44	-20 to +60	40000/60°C
<b>109P0424D601</b>		12 to 27.6	0.13	3.12	11000	0.31 10.9	124 0.498	42		
<b>109P0424H601</b>		12 to 27.6	0.07	1.68	8300	0.233 8.2	69.6 0.28	35		
<b>109P0424F601</b>		14 to 27.6	0.06	1.44	6500	0.183 6.5	45.1 0.181	28		
<b>109P0424B601</b>		20.4 to 27.6	0.06	1.44	5200	0.14 4.9	28.3 0.114	25		

Other sensor specifications are available as options. Refer to the index (pp. 543 to 544).

## Airflow - Static Pressure Characteristics

**109P0405J601** With pulse sensor

Operating voltage range

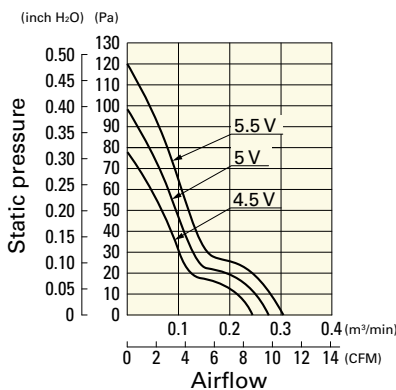

**109P0405H601** With pulse sensor

Operating voltage range

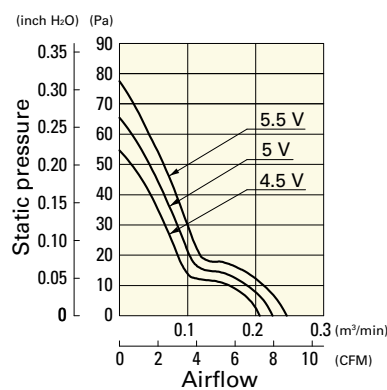

**109P0405F601** With pulse sensor

Operating voltage range

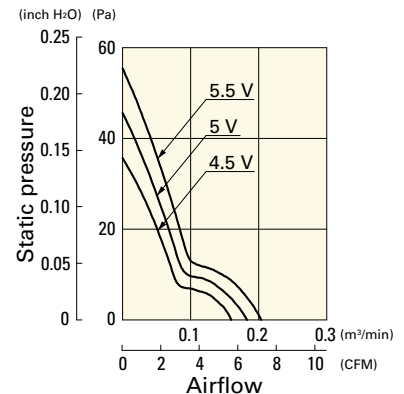

# Airflow - Static Pressure Characteristics

**109P0405M601** With pulse sensor

Operating voltage range

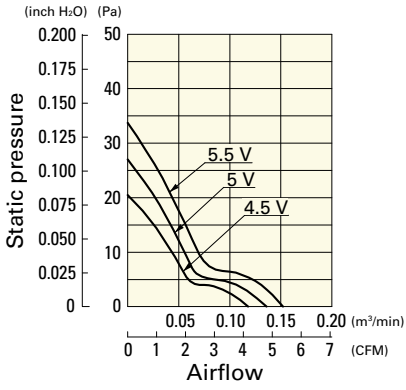

**109P0412G601** With pulse sensor

Operating voltage range

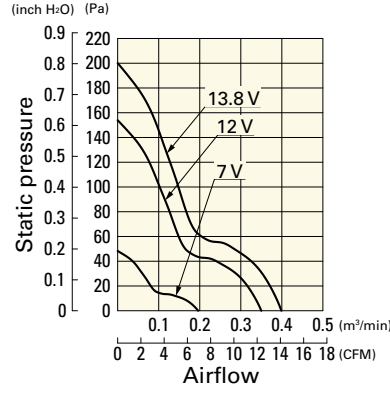

**109P0412D601** With pulse sensor

Operating voltage range

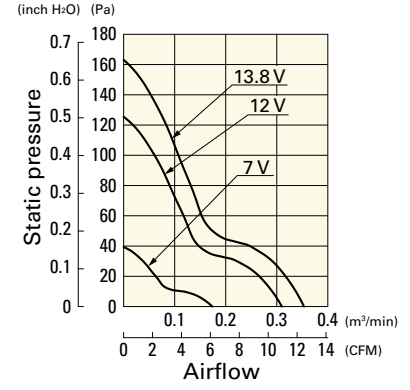

**109P0412E601** With pulse sensor

Operating voltage range

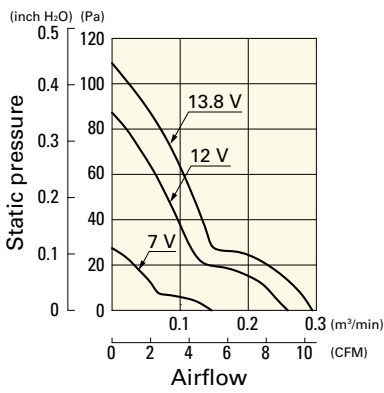

**109P0412H601** With pulse sensor

Operating voltage range

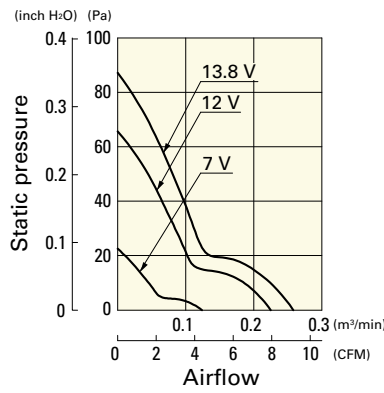

**109P0412F601** With pulse sensor

Operating voltage range

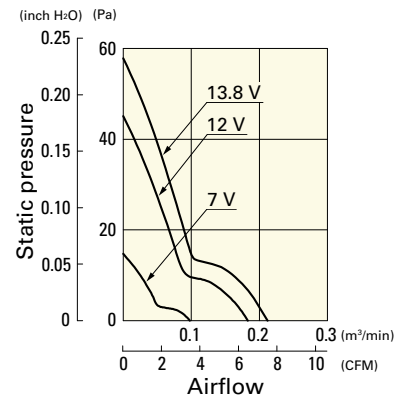

**109P0412M601** With pulse sensor

Operating voltage range

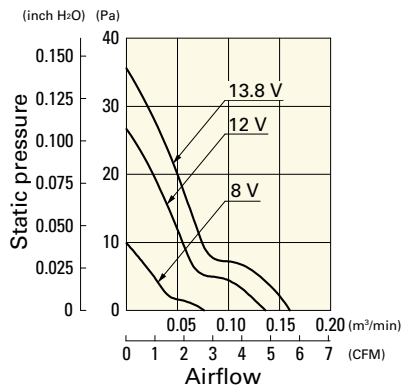

**109P0424G601** With pulse sensor

Operating voltage range

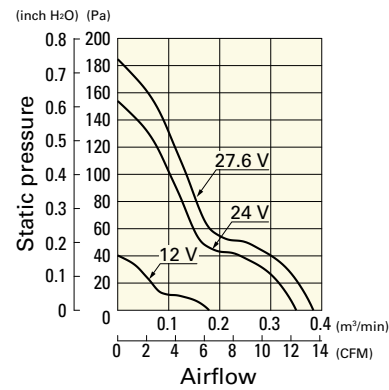

**109P0424D601** With pulse sensor

Operating voltage range

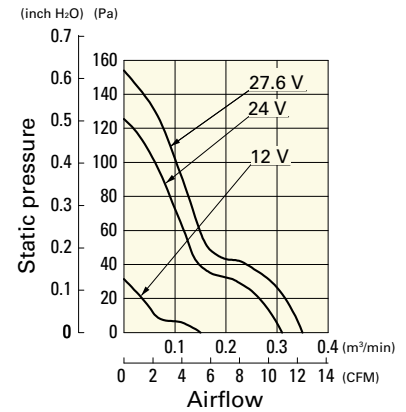

**109P0424H601** With pulse sensor

Operating voltage range

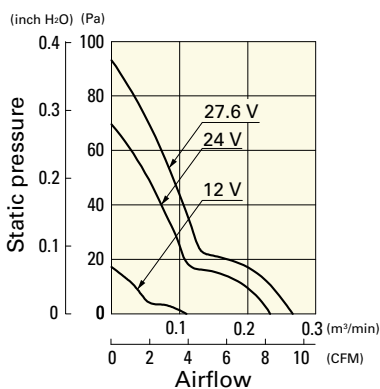

**109P0424F601** With pulse sensor

Operating voltage range

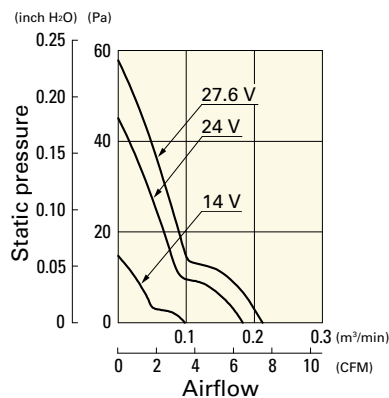

**109P0424B601** With pulse sensor

Operating voltage range

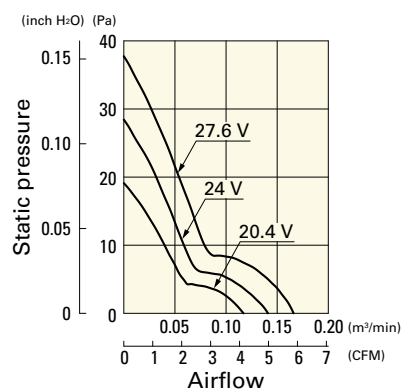

**Dimensions (unit: mm)**

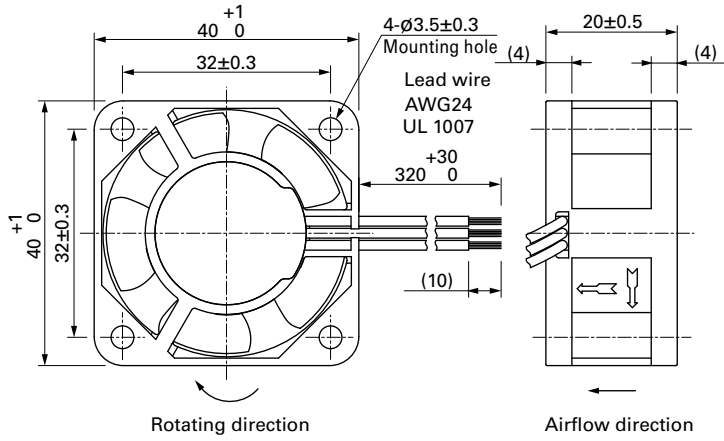

**Reference Dimensions of Mounting Holes and Vent Opening (unit: mm)**

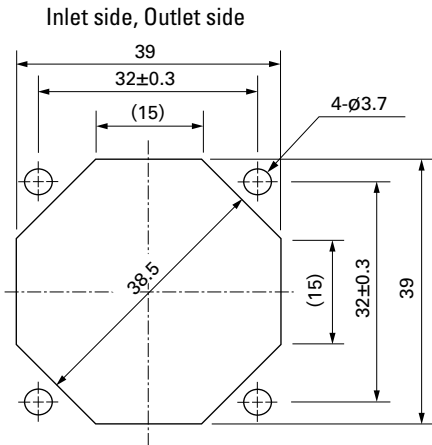

**Options**

Finger guards

page: p. 513

Model no.: 109-059, 109-059H

# Mouser Electronics

Authorized Distributor

Click to View Pricing, Inventory, Delivery & Lifecycle Information:

## Sanyo Denki:

[109P0405F601](#) [109P0405H601](#) [109P0405J601](#) [109P0405M601](#) [109P0412D601](#) [109P0412E601](#) [109P0412F601](#)  
[109P0412G601](#) [109P0412H601](#) [109P0412M601](#) [109P0424B601](#) [109P0424D601](#) [109P0424F601](#) [109P0424G601](#)  
[109P0424H601](#) [109P0412H602](#) [109P0405H602](#) [109P0412M602](#) [109P0405H6D01](#) [109P0424H602](#) [109P0412D602](#)  
[109P0424D6D01](#) [109P0412E6D01](#) [109P0412D6D01](#) [109P0424H6D01](#) [109P0412F602](#) [109P0424B6D01](#)  
[109P0412G6D01](#) [109P0412G602](#) [109P0424D602](#) [109P0424G602](#) [109P0412E602](#) [109P0412M6D01](#)  
[109P0424F6D01](#) [109P0424F602](#) [109P0424B602](#) [109P0412F6D01](#) [109P0412H6D01](#) [109P0405F602](#)  
[109P0405M6D01](#) [109P0405F6D01](#) [109P0405J602](#) [109P0405M602](#) [109P0405J6D01](#)