

ENCLOSURE DRAWING (To convert to inches divide by 25.4.)

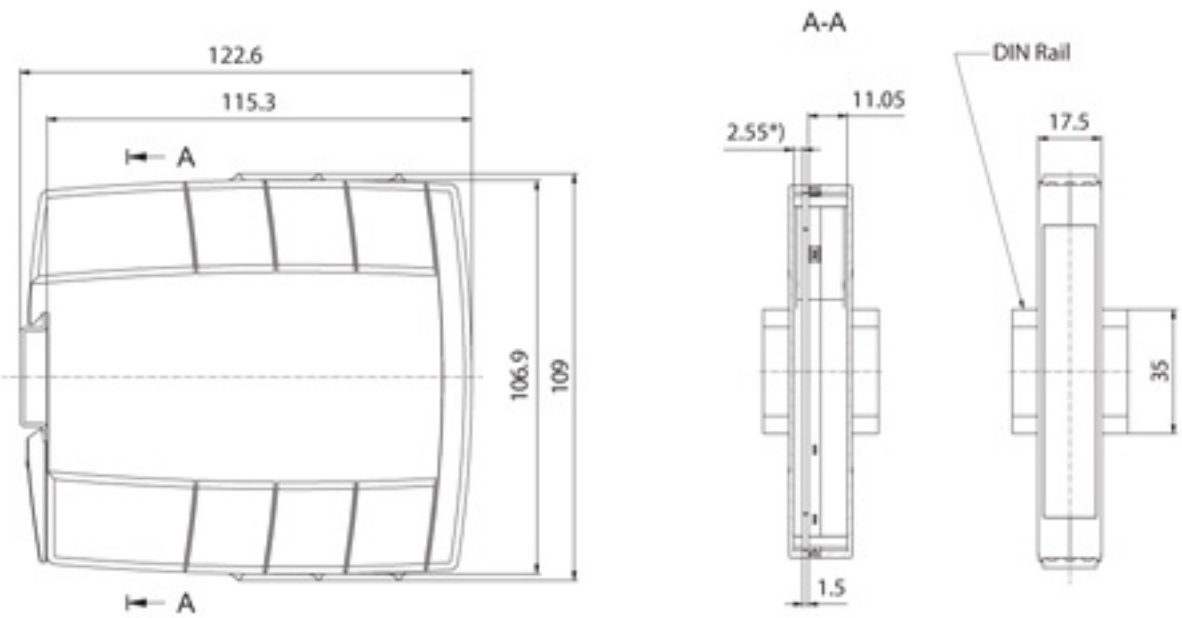

*) 3.05 with printed circuit board thickness $t = 1$ mm

PCB DRAWING (To convert to inches divide by 25.4.)

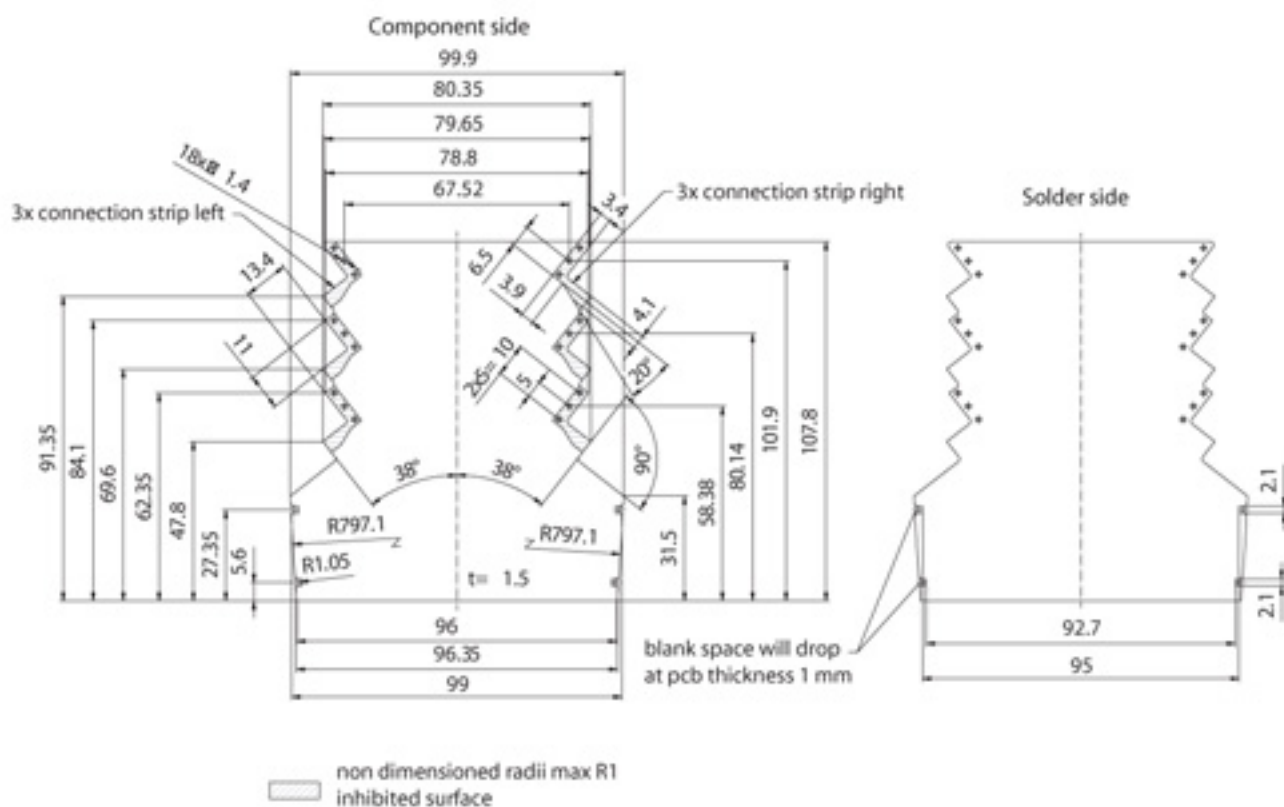

Mouser Electronics

Authorized Distributor

Click to View Pricing, Inventory, Delivery & Lifecycle Information:

[Altech:](#)

[90.131](#)