

## Overview

The A72 Series is constructed of polypropylene film and metal foil or metallized film and metal foil with axial leads of tinned wire. The axial leads are electrically welded to the metal layer on the ends of the capacitor winding. The capacitor is encapsulated in a polyester tape wrapping case with thermosetting resin material. Two different winding constructions are used depending on voltage parameters. Please see the Performance Characteristics for more information.

## Applications

Typical applications include resonant circuit, high frequency medium to high current, silicon-controlled rectifier (SCR and IGBT) as well as applications with high voltage and medium to high current.

Not suitable for across-the-line application (see Suppressor Capacitors).

## Benefits

- Voltage range: 100 – 2,000 VDC
- Capacitance range: 47 pF – 0.33  $\mu$ F
- Diameter: 5 – 22.5 mm
- Length: 11 – 33 mm
- Capacitance tolerance:  $\pm$ 5%,  $\pm$ 10%,  $\pm$ 20%
- Climatic category: 55/105/56 IEC 60068-1
- Operating temperature range of -55°C to +105°C
- RoHS compliance and lead-free terminations
- Tape & Reel packaging in accordance with IEC 60286-1
- Self-healing

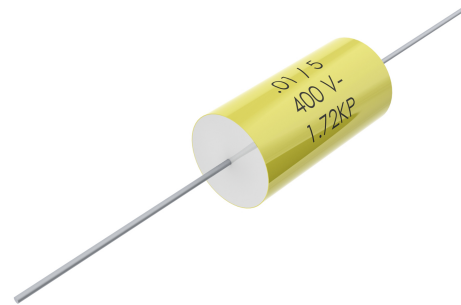

## Part Number System

A72	E	F	1470	AA	00	J
Series	Rated Voltage (VDC)	Length (mm)	Capacitance Code (pF)	Packaging	Internal Use	Capacitance Tolerance
Polypropylene Film/Foil	E = 100 I = 250 M = 400 P = 630 Q = 1000 S = 1500 U = 2000	F = 11 H = 14 K = 20.5 Q = 28 T = 33	The last three digits represent significant figures. The first digit specifies the total number of zeros to be added.	See Ordering Options Table	00, 02 (Standard)	J = $\pm$ 5% K = $\pm$ 10% M = $\pm$ 20%

## Ordering Options Table

Type of Leads and Packaging	Lead Length (mm)	Lead and Packaging Code
Bulk (Bag) – Short Leads	40±5	AA
Tape & Reel (Standard Reel Ø 355 mm)	H <sub>0</sub> = 18.5 ±0.5	26

## Dimensions – Millimeters

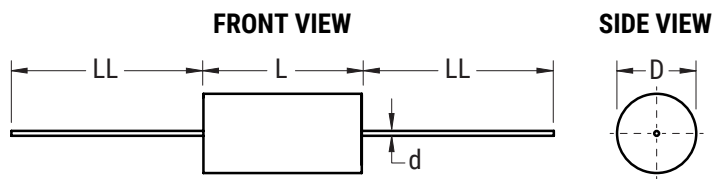

D		L		d	
Nominal	Tolerance	Nominal	Tolerance	Nominal	Tolerance
5.0	Maximum	11.0	Maximum	0.5	±0.05
6.5	Maximum	16.5	Maximum	0.6	±0.05
7.0	Maximum	16.5	Maximum	0.6	±0.05
7.5	Maximum	16.5	Maximum	0.6	±0.05
8.0	Maximum	16.5	Maximum	0.8	±0.05
8.0	Maximum	20.5	Maximum	0.8	±0.05
8.0	Maximum	28.0	Maximum	0.8	±0.05
8.5	Maximum	16.5	Maximum	0.8	±0.05
8.5	Maximum	20.5	Maximum	0.8	±0.05
8.5	Maximum	28.0	Maximum	0.8	±0.05
9.0	Maximum	16.5	Maximum	0.8	±0.05
9.0	Maximum	28.0	Maximum	0.8	±0.05
9.5	Maximum	20.5	Maximum	0.8	±0.05
9.5	Maximum	28.0	Maximum	0.8	±0.05
10.0	Maximum	28.0	Maximum	0.8	±0.05

**Note: See Ordering Options Table for lead length (LL / l) options.**

D		L		d	
Nominal	Tolerance	Nominal	Tolerance	Nominal	Tolerance
11.0	Maximum	20.5	Maximum	0.8	±0.05
11.0	Maximum	28.0	Maximum	0.8	±0.05
11.5	Maximum	28.0	Maximum	0.8	±0.05
12.5	Maximum	28.0	Maximum	0.8	±0.05
13.0	Maximum	28.0	Maximum	0.8	±0.05
13.5	Maximum	28.0	Maximum	0.8	±0.05
13.5	Maximum	33.0	Maximum	0.8	±0.05
14.0	Maximum	33.0	Maximum	0.8	±0.05
16.0	Maximum	33.0	Maximum	1.0	±0.05
16.5	Maximum	33.0	Maximum	1.0	±0.05
18.0	Maximum	33.0	Maximum	1.0	±0.05
19.0	Maximum	33.0	Maximum	1.0	±0.05
19.5	Maximum	33.0	Maximum	1.0	±0.05
20.0	Maximum	33.0	Maximum	1.0	±0.05
22.5	Maximum	33.0	Maximum	1.0	±0.05

**Note: See Ordering Options Table for lead length (LL / l) options.**

## Performance Characteristics

Dielectric	Polypropylene film						
Plates	Metal foil for 1 section, metal foil + metallized film for 2 sections						
Winding	Non-inductive type						
Leads	Tinned wire						
Protection	Plastic case, thermosetting resin filled. Box material is solvent resistant and flame retardant according to UL94.						
Related Documents	IEC 60384-13						
Sections	1			2			
Voltage Range (VDC)	100	250	400	630	1,000	1,500	2,000
Voltage Range (VAC)	63	125	160	300	400	450	500
Capacitance Range (µF)	0.0047 – 0.01	0.0022 – 0.015	0.000047 – 0.01	0.015 – 0.33	0.0033 – 0.1	0.0022 – 0.068	0.001 – 0.047
Capacitance Values	E6 series (IEC 60063) measured at 1 kHz and +20 ±1°C						
Capacitance Tolerance	±5%, ±10%, ±20%						
Operating temperature Range	-55°C to +105°C						
Maximum Self-heating	10°C at Rated Temperature						
Rated Temperature T <sub>R</sub>	+85°C						
Voltage Derating	Above +85°C DC and AC voltage derating is 1.25%/°C						
Climatic Category	55/105/56 IEC 60068-1						

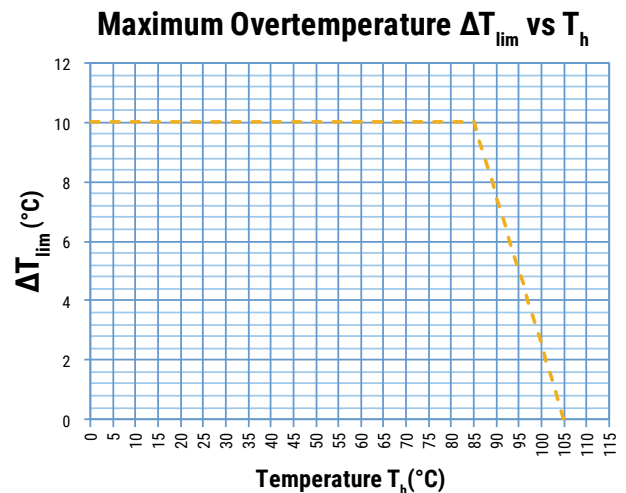
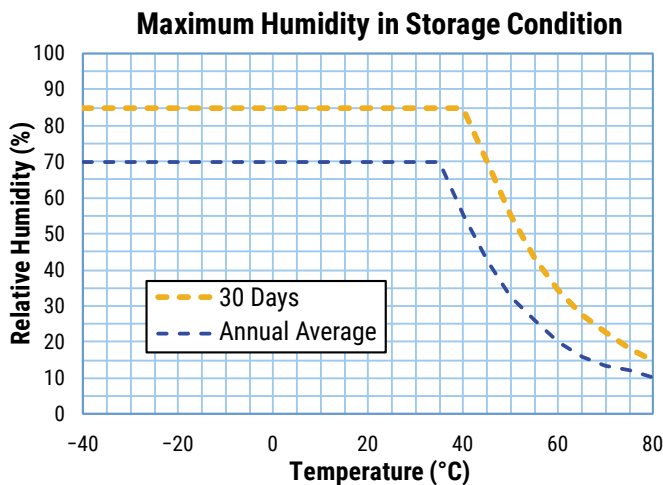

T<sub>h</sub> is the maximum ambient temperature surrounding the capacitor or hottest contact point (e.g. tracks), whichever is higher, in the worst operation conditions in °C.

## Performance Characteristics cont.

Storage Conditions	Storage time: $\leq 24$ months from the date marked on the package label		
	Average relative humidity per year $\leq 70\%$		
	RH $\leq 85\%$ for 30 days randomly distributed throughout the year		
	Dew is absent		
	Temperature: $-40$ to $80^{\circ}\text{C}$ (see "Maximum Humidity in Storage Conditions" graph below)		
Test Voltage	$2 \times V_R$ VDC for 2 seconds (between terminations) at $+25^{\circ}\text{C} \pm 5^{\circ}\text{C}$		
Capacitance Drift	Maximum 0.5% after a 2 year storage period at a temperature of $+10^{\circ}\text{C}$ to $+40^{\circ}\text{C}$ and a relative humidity of 40% to 60%		
Maximum Pulse Steepness	dV/dt according to Table 1. For working voltages lower than rated voltage ( $V < V_R$ ), the specified dV/dt can be multiplied by the factor $V_R/V$ .		
Temperature Coefficient	$-(150 \pm 70)$ ppm/ $^{\circ}\text{C}$ at 1 kHz		
Self Inductance (Lead Length $\sim 2$ mm)	Maximum 1 nH per 1 mm lead and capacitor length.		
Dissipation Factor $\tan\delta$	Maximum Values at $25^{\circ}\text{C} \pm 5^{\circ}\text{C}$		
	Frequency	$C \leq 0.1 \mu\text{F}$	$C \geq 0.1 \mu\text{F}$
	10 kHz	0.05%	0.05%
	100 kHz	0.10%	-
Insulation Resistance	Measured at $+25^{\circ}\text{C}$ , 100 VDC 60 seconds		
	Minimum Values Between Terminals		
	All Capacitance Values		
	$\geq 100,000 \text{ M}\Omega$ ( $\geq 500,000 \text{ M}\Omega$ )*		

\* Typical value

## Maximum Voltage ( $V_{rms}$ ) vs. Frequency (Sinusoidal Waveform/ $T_h \leq +40^\circ C$ )

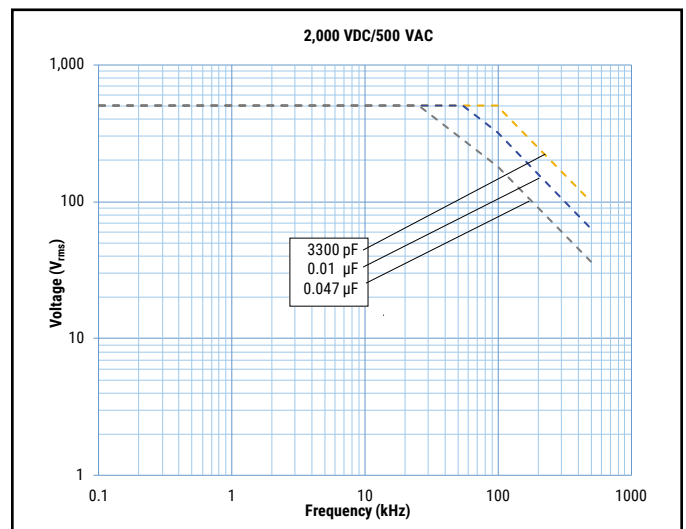
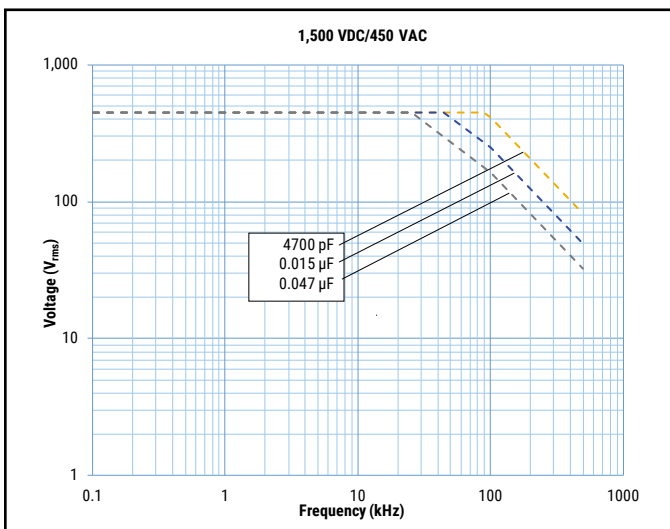
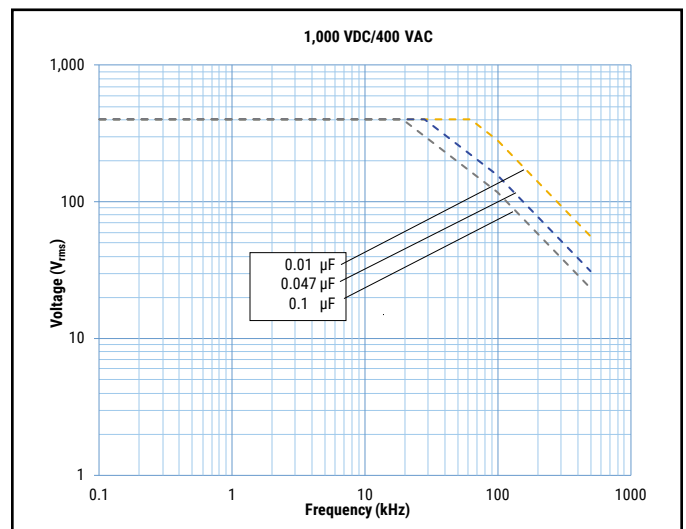
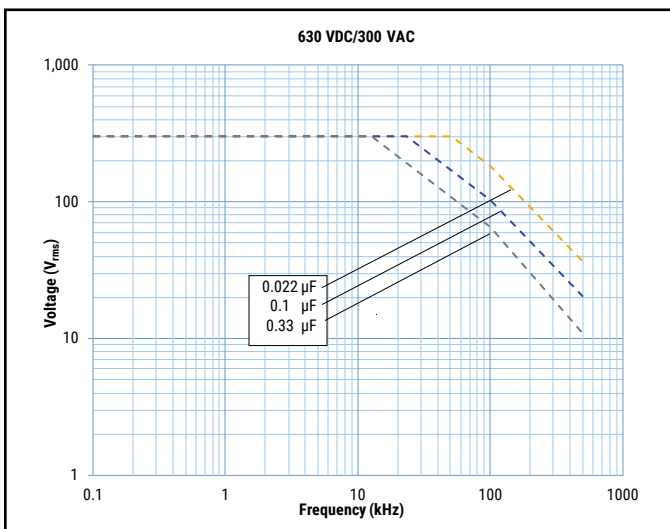
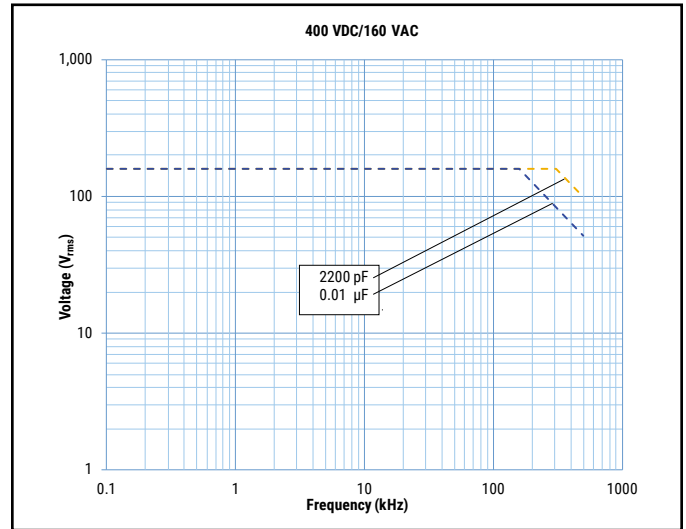
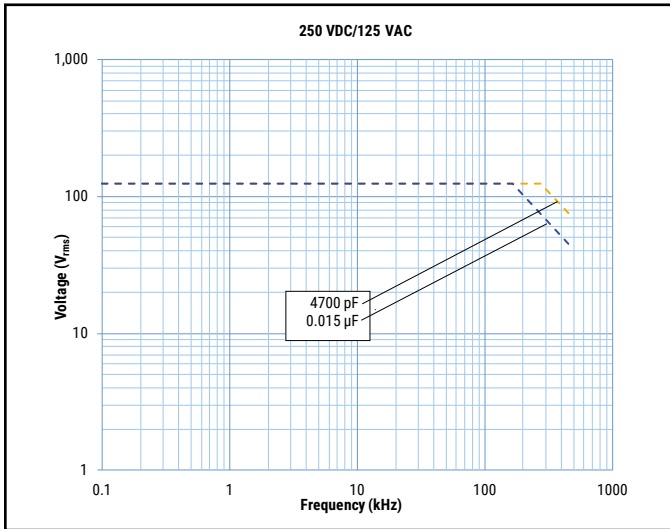

## Maximum Current ( $I_{rms}$ ) vs. Frequency (Sinusoidal Waveform/ $Th \leq +40^\circ C$ )

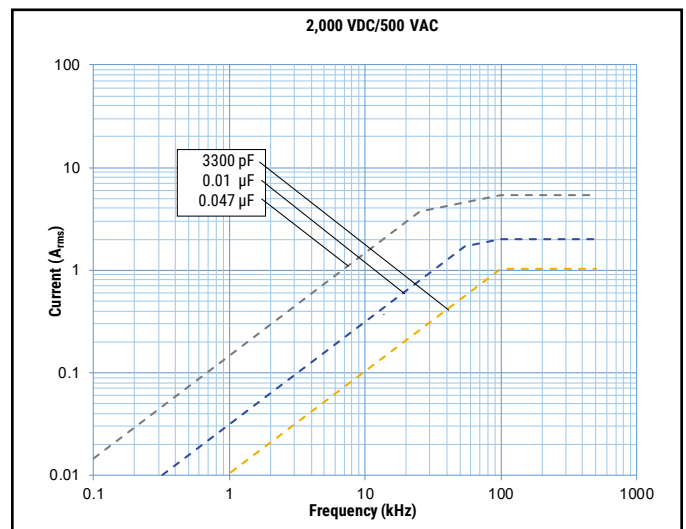
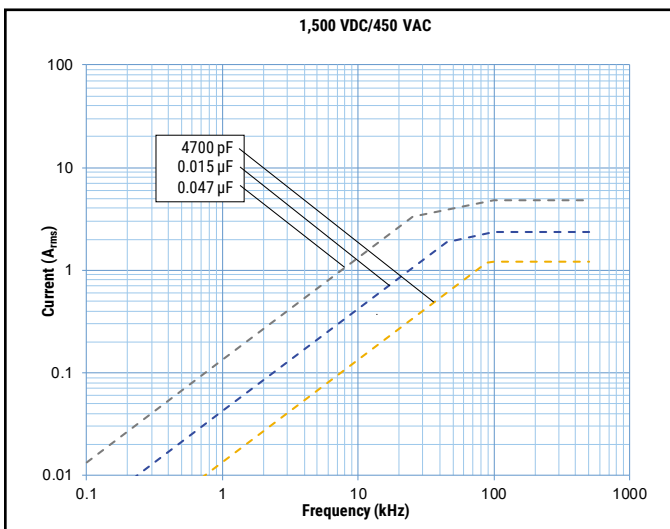
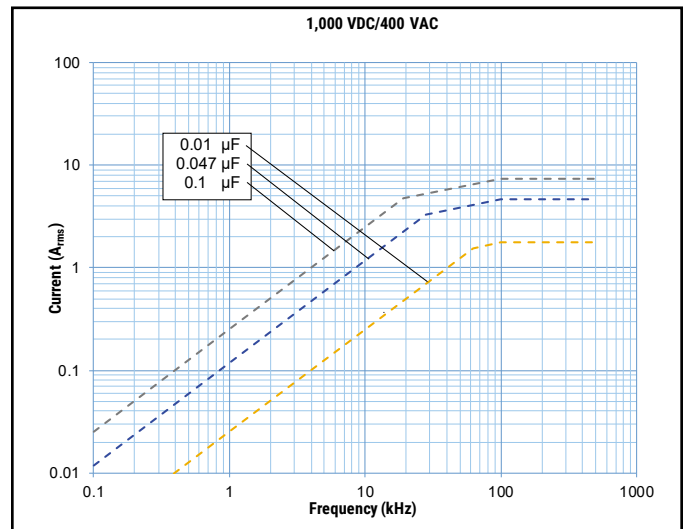
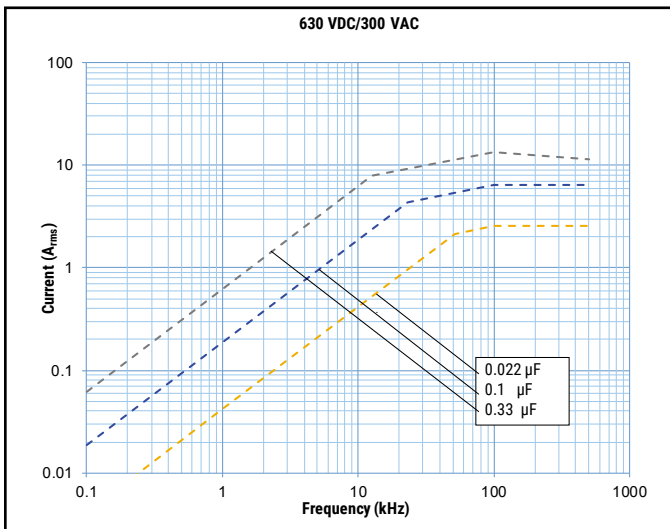
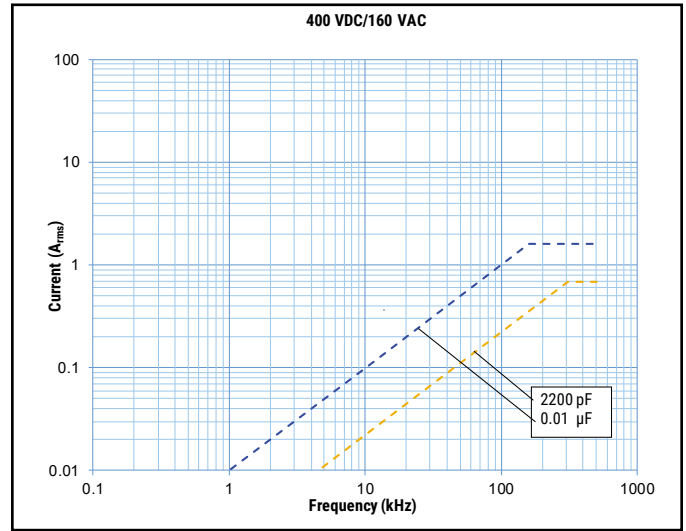
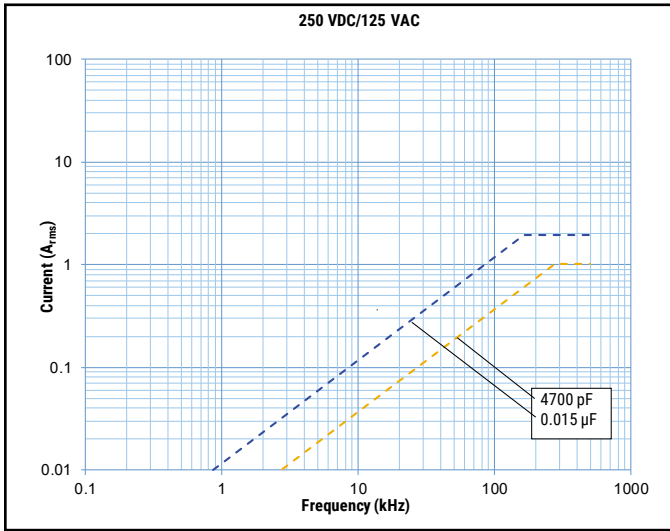

## Environmental Test Data

Damp Heat, Steady State Test	Test Conditions:		Performances
	Temperature: Relative humidity (RH): Test duration:	+40°C ±2°C 93% ±2% 56 days	Δ C/C  ≤ 2%, Δ tanδ ≤ 0.0005 at 1 kHz IR after test ≥ 50% of initial limit
Endurance Test	Test Conditions		Performances
	Temperature: Voltage applied: Test duration:	+85°C ±2°C 1.5 x V <sub>R</sub> (DC) 1,000 hours	Δ C/C  ≤ 2%, Δ tanδ ≤ 0.0005 at 1 kHz IR after test ≥ 50% of initial limit
Resistance to Soldering Heat Test	Test Conditions		Performances
	Solder bath temperature: Dipping time (with heat screen):	260°C ±5°C 10 seconds ±1 second	Δ C/C  ≤ 1%, Δ tanδ ≤ 0.0005 at 1 kHz IR after test ≥ initial limit

## Environmental Compliance

All KEMET pulse capacitors are RoHS Compliant, except A72 Series components with letter "F" (L Max = 11mm) in the 4th digit of the KEMET Part Number and 5th digit of the Customer Part Number.

**Table 1 – Ratings & Part Number Reference**

VDC	VAC	Capacitance Value (μF)	Dimensions in mm		dV/dt (V/μs)	Max K <sub>0</sub> (V <sup>2</sup> /μs)	KEMET Internal Part Number	Customer Part Number
			D Max	L Max				
100	63	0.0047	5.0	11.0	3,000	600,000	72EF1470(1)00(2)	A72EF1470(1)00(2)
100	63	0.0068	5.0	11.0	3,000	600,000	72EF1680(1)00(2)	A72EF1680(1)00(2)
100	63	0.010	5.0	11.0	3,000	600,000	72EF2100(1)00(2)	A72EF2100(1)00(2)
250	125	0.0022	5.0	11.0	5,000	2,500,000	72IF1220(1)00(2)	A72IF1220(1)00(2)
250	125	0.0033	5.0	11.0	5,000	2,500,000	72IF1330(1)00(2)	A72IF1330(1)00(2)
250	125	0.0047	7.0	16.5	4,500	2,250,000	72II1470(1)00(2)	A72II1470(1)00(2)
250	125	0.0068	7.0	16.5	4,500	2,250,000	72II1680(1)00(2)	A72II1680(1)00(2)
250	125	0.010	7.5	16.5	4,500	2,250,000	72II2100(1)00(2)	A72II2100(1)00(2)
250	125	0.015	8.5	16.5	4,500	2,250,000	72II2150(1)00(2)	A72II2150(1)00(2)
400	160	0.000047	5.0	11.0	13,000	10,400,000	72MF0047(1)00(2)	A72MF0047(1)00(2)
400	160	0.000068	5.0	11.0	13,000	10,400,000	72MF0068(1)00(2)	A72MF0068(1)00(2)
400	160	0.00010	5.0	11.0	13,000	10,400,000	72MF0100(1)00(2)	A72MF0100(1)00(2)
400	160	0.00015	5.0	11.0	13,000	10,400,000	72MF0150(1)00(2)	A72MF0150(1)00(2)
400	160	0.00022	5.0	11.0	13,000	10,400,000	72MF0220(1)00(2)	A72MF0220(1)00(2)
400	160	0.00033	5.0	11.0	13,000	10,400,000	72MF0330(1)00(2)	A72MF0330(1)00(2)
400	160	0.00047	5.0	11.0	13,000	10,400,000	72MF0470(1)00(2)	A72MF0470(1)00(2)
400	160	0.00068	5.0	11.0	13,000	10,400,000	72MF0680(1)00(2)	A72MF0680(1)00(2)
400	160	0.0010	5.0	11.0	13,000	10,400,000	72MF1100(1)00(2)	A72MF1100(1)00(2)
400	160	0.0015	5.0	11.0	13,000	10,400,000	72MF1150(1)00(2)	A72MF1150(1)00(2)
400	160	0.0022	6.5	16.5	6,500	5,200,000	72MI1220(1)00(2)	A72MI1220(1)00(2)
400	160	0.0033	6.5	16.5	6,500	5,200,000	72MI1330(1)00(2)	A72MI1330(1)00(2)
400	160	0.0047	7.0	16.5	6,500	5,200,000	72MI1470(1)00(2)	A72MI1470(1)00(2)
VDC	VAC	Capacitance Value (μF)	B (mm)	H (mm)	dV/dt (V/μs)	Max K <sub>0</sub> (V <sup>2</sup> /μs)	KEMET Internal Part Number	Customer Part Number

(1) Insert lead and packaging code. See Ordering Options Table for available options.

(2) J = 5%, K = 10%, M = 20%.

**Table 1 – Ratings & Part Number Reference cont.**

VDC	VAC	Capacitance Value (µF)	Dimensions in mm		dV/dt (V/µs)	Max K <sub>0</sub> (V <sup>2</sup> /µs)	KEMET Internal Part Number	Customer Part Number
			D Max	L Max				
400	160	0.0068	8.0	16.5	6,500	5,200,000	72MI1680(1)00(2)	A72MI1680(1)00(2)
400	160	0.010	9.0	16.5	6,500	5,200,000	72MI2100(1)00(2)	A72MI2100(1)00(2)
630	300	0.015	8.5	20.5	4,300	5,418,000	72PK2150(1)00(2)	A72PK2150(1)00(2)
630	300	0.022	9.5	20.5	4,300	5,418,000	72PK2220(1)00(2)	A72PK2220(1)00(2)
630	300	0.033	9.0	28.0	2,600	3,276,000	72PQ2330(1)00(2)	A72PQ2330(1)00(2)
630	300	0.047	10.0	28.0	2,600	3,276,000	72PQ2470(1)00(2)	A72PQ2470(1)00(2)
630	300	0.068	11.5	28.0	2,600	3,276,000	72PQ2680(1)00(2)	A72PQ2680(1)00(2)
630	300	0.10	13.5	28.0	2,600	3,276,000	72PQ3100(1)00(2)	A72PQ3100(1)00(2)
630	300	0.15	14.0	33.0	1,800	2,268,000	72PT3150(1)00(2)	A72PT3150(1)00(2)
630	300	0.22	16.5	33.0	1,800	2,268,000	72PT3220(1)00(2)	A72PT3220(1)00(2)
630	300	0.33	19.5	33.0	1,800	2,268,000	72PT3330(1)00(2)	A72PT3330(1)00(2)
1,000	400	0.0033	8.5	20.5	14,000	28,000,000	72QK1330(1)02(2)	A72QK1330(1)02(2)
1,000	400	0.0047	9.5	20.5	14,000	28,000,000	72QK1470(1)02(2)	A72QK1470(1)02(2)
1,000	400	0.0068	8.0	28.0	5,000	10,000,000	72QQ1680(1)02(2)	A72QQ1680(1)02(2)
1,000	400	0.010	8.5	28.0	5,000	10,000,000	72QQ2100(1)02(2)	A72QQ2100(1)02(2)
1,000	400	0.015	10.0	28.0	5,000	10,000,000	72QQ2150(1)02(2)	A72QQ2150(1)02(2)
1,000	400	0.022	11.0	28.0	5,000	10,000,000	72QQ2220(1)02(2)	A72QQ2220(1)02(2)
1,000	400	0.033	13.0	28.0	5,000	10,000,000	72QQ2330(1)02(2)	A72QQ2330(1)02(2)
1,000	400	0.047	14.0	33.0	3,700	7,400,000	72QT2470(1)02(2)	A72QT2470(1)02(2)
1,000	400	0.068	16.0	33.0	3,700	7,400,000	72QT2680(1)02(2)	A72QT2680(1)02(2)
1,000	400	0.10	19.0	33.0	3,700	7,400,000	72QT3100(1)02(2)	A72QT3100(1)02(2)
1,500	450	0.0022	8.0	20.5	17,000	51,000,000	72SK1220(1)00(2)	A72SK1220(1)00(2)
1,500	450	0.0033	9.5	20.5	17,000	51,000,000	72SK1330(1)00(2)	A72SK1330(1)00(2)
1,500	450	0.0047	8.5	28.0	6,000	18,000,000	72SQ1470(1)00(2)	A72SQ1470(1)00(2)
1,500	450	0.0068	8.5	28.0	6,000	18,000,000	72SQ1680(1)00(2)	A72SQ1680(1)00(2)
1,500	450	0.010	9.5	28.0	6,000	18,000,000	72SQ2100(1)00(2)	A72SQ2100(1)00(2)
1,500	450	0.015	11.0	28.0	6,000	18,000,000	72SQ2150(1)00(2)	A72SQ2150(1)00(2)
1,500	450	0.022	12.5	28.0	6,000	18,000,000	72SQ2220(1)00(2)	A72SQ2220(1)00(2)
1,500	450	0.033	13.5	33.0	4,500	13,500,000	72ST2330(1)00(2)	A72ST2330(1)00(2)
1,500	450	0.047	16.0	33.0	4,500	13,500,000	72ST2470(1)00(2)	A72ST2470(1)00(2)
1,500	450	0.068	18.0	33.0	4,500	13,500,000	72ST2680(1)00(2)	A72ST2680(1)00(2)
2,000	500	0.0010	8.5	20.5	27,000	108,000,000	72UK1100(1)00(2)	A72UK1100(1)00(2)
2,000	500	0.0015	9.5	20.5	27,000	108,000,000	72UK1150(1)00(2)	A72UK1150(1)00(2)
2,000	500	0.0022	11.0	20.5	27,000	108,000,000	72UK1220(1)00(2)	A72UK1220(1)00(2)
2,000	500	0.0033	9.0	28.0	9,800	39,200,000	72UQ1330(1)00(2)	A72UQ1330(1)00(2)
2,000	500	0.0047	9.5	28.0	9,800	39,200,000	72UQ1470(1)00(2)	A72UQ1470(1)00(2)
2,000	500	0.0068	11.0	28.0	9,800	39,200,000	72UQ1680(1)00(2)	A72UQ1680(1)00(2)
2,000	500	0.010	13.0	28.0	9,800	39,200,000	72UQ2100(1)00(2)	A72UQ2100(1)00(2)
2,000	500	0.015	13.5	33.0	7,000	28,000,000	72UT2150(1)00(2)	A72UT2150(1)00(2)
2,000	500	0.022	16.0	33.0	7,000	28,000,000	72UT2220(1)00(2)	A72UT2220(1)00(2)
2,000	500	0.033	20.0	33.0	7,000	28,000,000	72UT2330(1)00(2)	A72UT2330(1)00(2)
2,000	500	0.047	22.5	33.0	7,000	28,000,000	72UT2470(1)00(2)	A72UT2470(1)00(2)
VDC	VAC	Capacitance Value (µF)	B (mm)	H (mm)	dV/dt (V/µs)	Max K <sub>0</sub> (V <sup>2</sup> /µs)	KEMET Internal Part Number	Customer Part Number

(1) Insert lead and packaging code. See Ordering Options Table for available options.

(2) J = 5%, K = 10%, M = 20%.



## Soldering Process

The implementation of the RoHS directive has resulted in the selection of SnAgCu (SAC) alloys or SnCu alloys as primary solder. This has increased the liquidus temperature from that of 183°C for SnPb eutectic alloy to 217 – 221°C for the new alloys. As a result, the heat stress to the components, even in wave soldering, has increased considerably due to higher pre-heat and wave temperatures. Polypropylene capacitors are especially sensitive to heat (the melting point of polypropylene is 160 – 170°C). Wave soldering can be destructive, especially for mechanically small polypropylene capacitors (with lead spacing of 5 mm to 15 mm), and great care has to be taken during soldering. The recommended solder profiles from KEMET should be used. Please consult KEMET with any questions. In general, the wave soldering curve from IEC Publication 61760–1 Edition 2 serves as a solid guideline for successful soldering. Please see Figure 1.

Reflow soldering is not recommended for through-hole film capacitors. Exposing capacitors to a soldering profile in excess of the above recommended limits may result in degradation or permanent damage to the capacitors.

Do not place the polypropylene capacitor through an adhesive curing oven to cure resin for surface mount components. Insert through-hole parts after the curing of surface mount parts. Consult KEMET to discuss the actual temperature profile in the oven, if through-hole components must pass through the adhesive curing process. A maximum two soldering cycles is recommended. Please allow time for the capacitor surface temperature to return to a normal temperature before the second soldering cycle.

### Manual Soldering Recommendations

Following is the recommendation for manual soldering with a soldering iron.

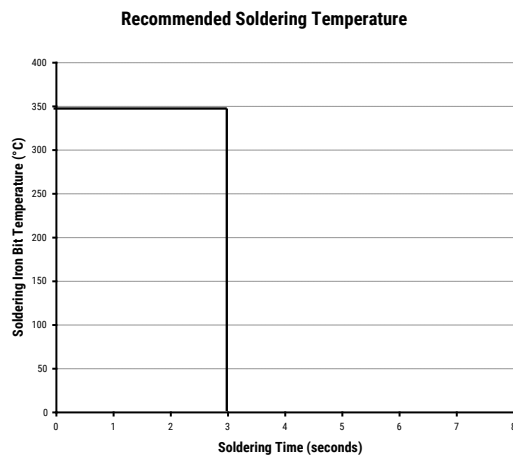

The soldering iron tip temperature should be set at 350°C (+10°C maximum) with the soldering duration not to exceed more than 3 seconds.

### Wave Soldering Recommendations

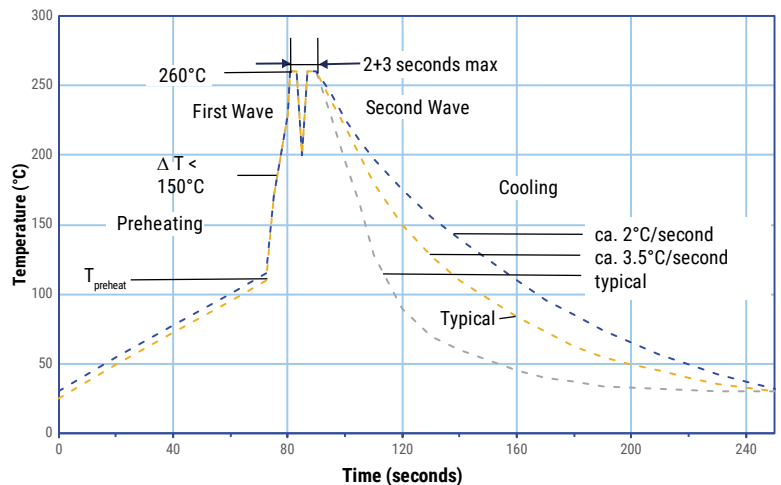

## Soldering Process cont.

### Wave Soldering Recommendations cont.

1. The table indicates the maximum set-up temperature of the soldering process  
Figure 1

Dielectric Film Material	Maximum Preheat Temperature		Maximum Peak Soldering Temperature	
	Capacitor Pitch ≤ 15 mm	Capacitor Pitch > 15 mm	Capacitor Pitch ≤ 15 mm	Capacitor Pitch > 15 mm
Polyester	130°C	130°C	270°C	270°C
Polypropylene	110°C	130°C	260°C	270°C
Paper	130°C	140°C	270°C	270°C
Polyphenylene Sulphide	150°C	160°C	270°C	270°C

2. The maximum temperature measured inside the capacitor:

Set the temperature so that inside the element the maximum temperature is below the limit:

Dielectric Film Material	Maximum temperature measured inside the element
Polyester	160°C
Polypropylene	110°C
Paper	160°C
Polyphenylene Sulphide	160°C



*Temperature monitored inside the capacitor.*

### Selective Soldering Recommendations

Selective dip soldering is a variation of reflow soldering. In this method, the printed circuit board with through-hole components to be soldered is preheated and transported over the solder bath as in normal flow soldering without touching the solder. When the board is over the bath, it is stopped and pre-designed solder pots are lifted from the bath with molten solder only at the places of the selected components, and pressed against the lower surface of the board to solder the components.

The temperature profile for selective soldering is similar to the double wave flow soldering outlined in this document, **however, instead of two baths, there is only one bath with a time from 3 to 10 seconds.** In selective soldering, the risk of overheating is greater than in double wave flow soldering. Great care must be taken so that the parts are not overheated.

## Construction

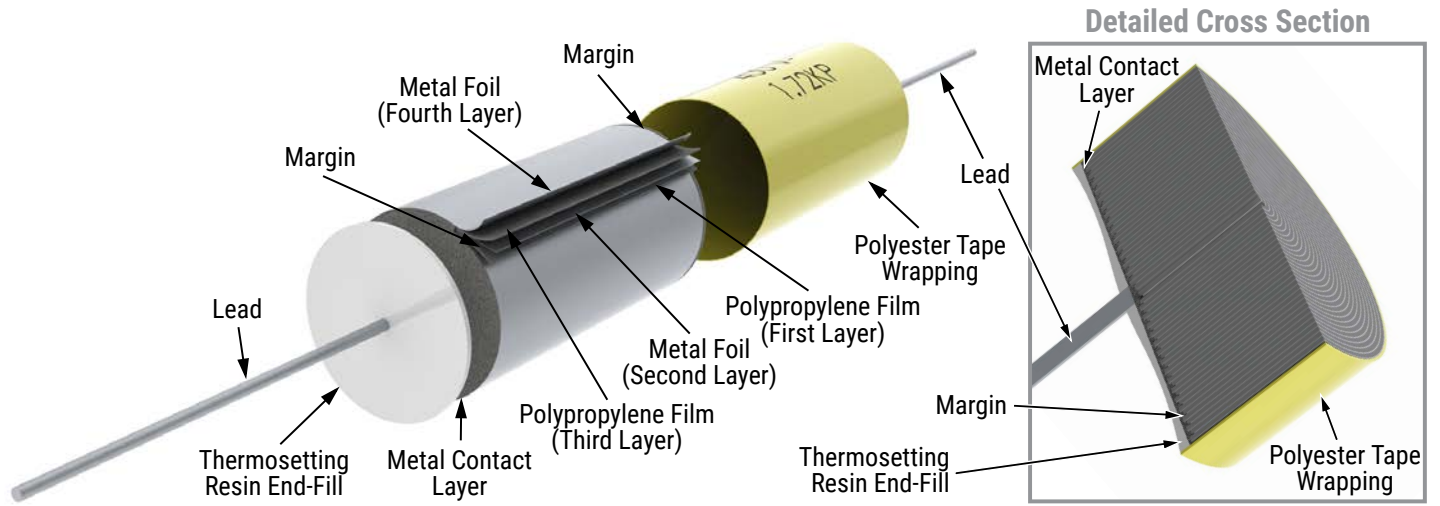

## Winding Schemes

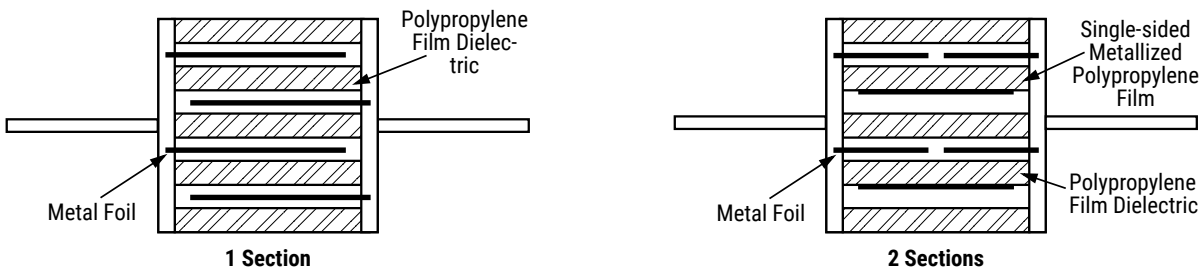

## Marking

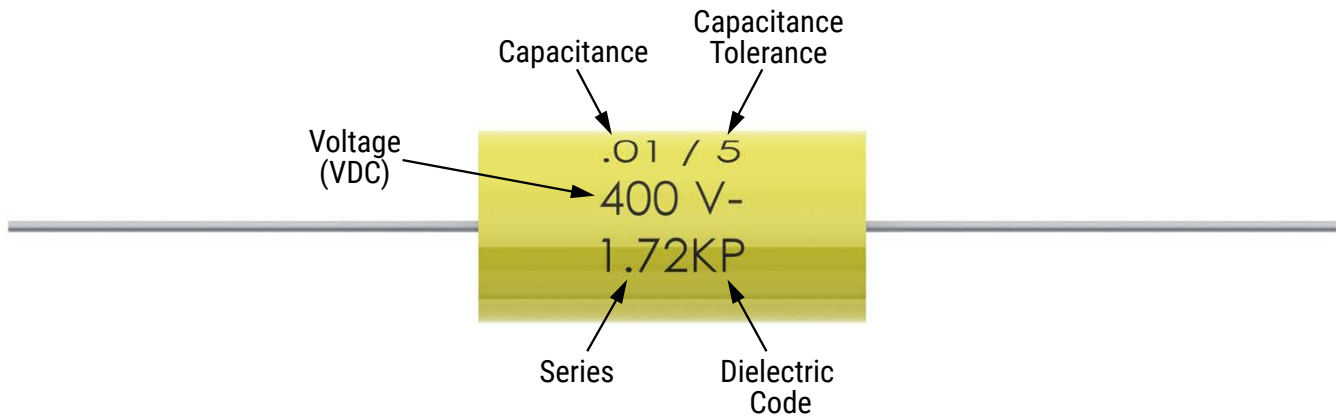

## Packaging Quantities

Diameter	Length	Bulk Long Leads	Standard Reel 355 mm
5.0	11.0	1,500	3,000
6.5	16.5	2,000	1,200
7.0	16.5	1,750	1,100
7.5	16.5	1,500	1,000
8.0	16.5	1,250	900
8.0	20.5	1,000	900
8.0	28.0	500	900
8.5	16.5	1,000	800
8.5	20.5	750	800
8.5	28.0	500	800
9.0	16.5	1,000	800
9.0	28.0	500	800
9.5	20.5	750	600
9.5	28.0	500	600
10.0	28.0	500	600

Diameter	Length	Bulk Long Leads	Standard Reel 355 mm
11.0	20.5	500	400
11.0	28.0	500	400
11.5	28.0	300	400
12.5	28.0	300	400
13.0	28.0	300	400
13.5	28.0	300	300
13.5	33.0	300	300
14.0	33.0	300	300
16.0	33.0	200	250
16.5	33.0	200	250
18.0	33.0	200	200
19.0	33.0	150	150
19.5	33.0	150	150
20.0	33.0	150	150
22.5	33.0	100	-

## Lead Taping & Packaging (IEC 60286-1)

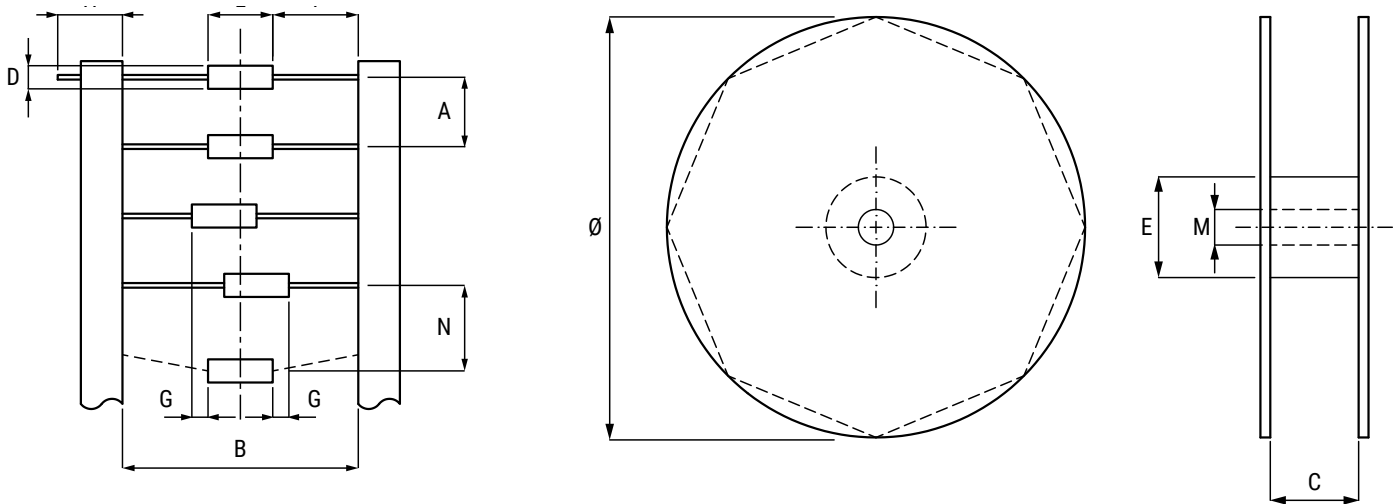

### Taping Specification

Description	Symbol	Dimensions (mm)
Component diameter	D	4.5 – 19.5
Body length	L	11 – 33
Component lead spacing	A <sup>(1)</sup>	See Table 1
Reel core diameter	E	85
Arbor hole diameter	M	30
Reel diameter	Ø	355 maximum
Tape width	H	6 ±0.5/9 ±1 <sup>(2)</sup>
Body location (lateral deviation)	G	≤ 0.7
Body location (longitudinal deviation)	N	≤ 1.2
Tape spacing	B	See Table 2
Lead length from the component body to the adhesive tape	I	≥ 20
Distance between reel flanges	C	See Table 2

(1) Maximum cumulative feed hole error 1.5 mm per 6 parts.

(2) 9±1 for capacitor with L ≥ 31.5.

**Table 1**

Dimensions in mm	
Diameter	A
≤ 5	5±0.5
5.1 – 9.5	10±0.5
9.6 – 14.7	15±0.5
14.8 – 19.5	20±1.0

**Table 2**

Dimensions in mm			
Length	Class	B <sup>±1.5</sup>	C
≤ 11	I	52.4	75
14 – 20.5	II	63.6	86
≥ 26	III	73	98

## KEMET Electronics Corporation Sales Offices

For a complete list of our global sales offices, please visit [www.kemet.com/sales](http://www.kemet.com/sales).

---

### Disclaimer

All product specifications, statements, information and data (collectively, the "Information") in this datasheet are subject to change. The customer is responsible for checking and verifying the extent to which the Information contained in this publication is applicable to an order at the time the order is placed. All Information given herein is believed to be accurate and reliable, but it is presented without guarantee, warranty, or responsibility of any kind, expressed or implied.

Statements of suitability for certain applications are based on KEMET Electronics Corporation's ("KEMET") knowledge of typical operating conditions for such applications, but are not intended to constitute – and KEMET specifically disclaims – any warranty concerning suitability for a specific customer application or use. The Information is intended for use only by customers who have the requisite experience and capability to determine the correct products for their application. Any technical advice inferred from this Information or otherwise provided by KEMET with reference to the use of KEMET's products is given gratis, and KEMET assumes no obligation or liability for the advice given or results obtained.

Although KEMET designs and manufactures its products to the most stringent quality and safety standards, given the current state of the art, isolated component failures may still occur. Accordingly, customer applications which require a high degree of reliability or safety should employ suitable designs or other safeguards (such as installation of protective circuitry or redundancies) in order to ensure that the failure of an electrical component does not result in a risk of personal injury or property damage.

Although all product-related warnings, cautions and notes must be observed, the customer should not assume that all safety measures are indicated or that other measures may not be required.

*KEMET is a registered trademark of KEMET Electronics Corporation.*