

NLU1GT32

Single 2-Input OR Gate, TTL Level

LSTTL-Compatible Inputs

The NLU1GT32 MiniGate™ is an advanced CMOS high-speed 2-input OR gate in ultra-small footprint.

The device input is compatible with TTL-type input thresholds and the output has a full 5.0 V CMOS level output swing.

The NLU1GT32 input and output structures provide protection when voltages up to 7.0 V are applied, regardless of the supply voltage.

Features

- High Speed: $t_{PD} = 3.7 \text{ ns}$ (Typ) @ $V_{CC} = 5.0 \text{ V}$
- Low Power Dissipation: $I_{CC} = 2 \mu\text{A}$ (Max) at $T_A = 25^\circ\text{C}$
- TTL-Compatible Input: $V_{IL} = 0.8 \text{ V}$; $V_{IH} = 2.0 \text{ V}$
- CMOS-Compatible Output: $V_{OH} > 0.8 V_{CC}$; $V_{OL} < 0.1 V_{CC}$ @ Load
- Power Down Protection Provided on inputs
- Balanced Propagation Delays
- Ultra-Small Packages
- These are Pb-Free Devices

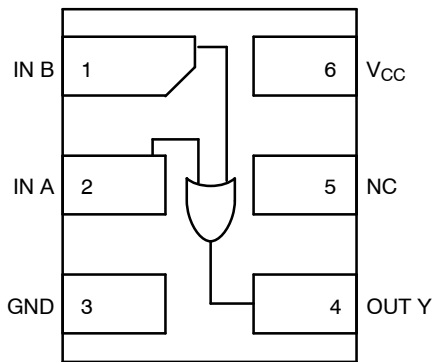

Figure 1. Pinout (Top View)

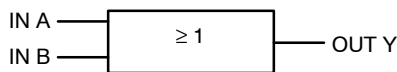

Figure 2. Logic Symbol

PIN ASSIGNMENT

1	IN B
2	IN A
3	GND
4	OUT Y
5	NC
6	V_{CC}

FUNCTION TABLE

Input		Output
A	B	Y
L	L	L
L	H	H
H	L	H
H	H	H



ON Semiconductor®

www.onsemi.com

MARKING DIAGRAMS

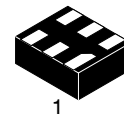

UDFN6
1.2 x 1.0
CASE 517AA



UDFN6
1.0 x 1.0
CASE 517BX

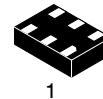

UDFN6
1.45 x 1.0
CASE 517AQ

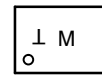

5 = Device Marking
M = Date Code

ORDERING INFORMATION

See detailed ordering and shipping information on page 4 of this data sheet.

NLU1GT32

MAXIMUM RATINGS

Symbol	Parameter	Value	Unit
V_{CC}	DC Supply Voltage	-0.5 to +7.0	V
V_{IN}	DC Input Voltage	-0.5 to +7.0	V
V_{OUT}	DC Output Voltage	-0.5 to +7.0	V
I_{IK}	DC Input Diode Current $V_{IN} < GND$	-20	mA
I_{OK}	DC Output Diode Current $V_{OUT} < GND$	±20	mA
I_O	DC Output Source/Sink Current	±12.5	mA
I_{CC}	DC Supply Current Per Supply Pin	±25	mA
I_{GND}	DC Ground Current per Ground Pin	±25	mA
T_{STG}	Storage Temperature Range	-65 to +150	°C
T_L	Lead Temperature, 1 mm from Case for 10 Seconds	260	°C
T_J	Junction Temperature Under Bias	150	°C
MSL	Moisture Sensitivity	Level 1	
F_R	Flammability Rating Oxygen Index: 28 to 34	UL 94 V-0 @ 0.125 in	
$I_{LATCHUP}$	Latchup Performance Above V_{CC} and Below GND at 125°C (Note 2)	±500	mA

Stresses exceeding those listed in the Maximum Ratings table may damage the device. If any of these limits are exceeded, device functionality should not be assumed, damage may occur and reliability may be affected.

1. Measured with minimum pad spacing on an FR4 board, using 10 mm-by-1 inch, 2 ounce copper trace no air flow.
2. Tested to EIA / JESD78.

RECOMMENDED OPERATING CONDITIONS

Symbol	Parameter	Min	Max	Unit
V_{CC}	Positive DC Supply Voltage	1.65	5.5	V
V_{IN}	Digital Input Voltage	0	5.5	V
V_{OUT}	Output Voltage	0	5.5	V
T_A	Operating Free-Air Temperature	-55	+125	°C
$\Delta t/\Delta V$	Input Transition Rise or Fall Rate $V_{CC} = 3.3 V \pm 0.3 V$ $V_{CC} = 5.0 V \pm 0.5 V$	0 0	100 20	ns/V

NLU1GT32

DC ELECTRICAL CHARACTERISTICS

Symbol	Parameter	Conditions	V _{CC} (V)	T _A = 25 °C			T _A = +85°C		T _A = -55°C to +125°C		Unit
				Min	Typ	Max	Min	Max	Min	Max	
V _{IH}	Low-Level Input Voltage		1.8 3.0 4.5 to 5.5	1.2 1.4 2.0			1.2 1.4 2.0		1.2 1.4 2.0		V
V _{IL}	Low-Level Input Voltage		1.8 3.0 4.5 to 5.5			0.3 0.53 0.8		0.3 0.53 0.8		0.3 0.53 0.8	V
V _{OH}	High-Level Output Voltage	V _{IN} = V _{IH} or V _{IL} I _{OH} = -50 μA	3.0 4.5	2.9 4.4	3.0 4.5		2.9 4.4		2.9 4.4		V
		V _{IN} = V _{IH} or V _{IL} I _{OH} = -2 mA I _{OH} = -4 mA I _{OH} = -8 mA	1.8 3.0 4.5	1.40 2.58 3.94			1.38 2.48 3.80		1.37 2.34 3.66		
V _{OL}	Low-Level Output Voltage	V _{IN} = V _{IH} or V _{IL} I _{OL} = 50 μA	3.0 4.5		0 0	0.1 0.1		0.1 0.1		0.1 0.1	V
		V _{IN} = V _{IH} or V _{IL} I _{OL} = 2 mA I _{OL} = 4 mA I _{OL} = 8 mA	1.8 3.0 4.5			0.36 0.36 0.36		0.44 0.44 0.44		0.52 0.52 0.52	
I _{IN}	Input Leakage Current	0 ≤ V _{IN} ≤ 5.5 V	0 to 5.5			±0.1		±1.0		±1.0	μA
I _{CC}	Quiescent Supply Current	0 ≤ V _{IN} ≤ V _{CC}	5.5			2.0		20		40	μA
I _{CC(T)}	Quiescent Supply Current	V _{IN} = 3.4 V	5.5			1.35		1.50		1.65	mA
I _{OPD}	Output Leakage Current	V _{OUT} = 5.5 V	0.0			0.5		5.0		10	μA

AC ELECTRICAL CHARACTERISTICS (Input t_r = t_f = 3.0 ns)

Symbol	Parameter	V _{CC} (V)	Test Condition	T _A = 25 °C			T _A = +85°C		T _A = -55°C to +125°C		Unit
				Min	Typ	Max	Min	Max	Min	Max	
t _{PLH} , t _{PHL}	Propagation Delay, Input A or B to Y	1.65 to 1.95	C _L = 15 pF			15.4		16.9		18.7	ns
			C _L = 50 pF			23.8		25.2		26.7	
		2.3 to 2.7	C _L = 15 pF			10.4		11.2		13.2	
			C _L = 50 pF			14.5		15.5		17.9	
		3.0 to 3.6	C _L = 15 pF		4.8	7.9		9.5		11.5	
			C _L = 50 pF		6.1	11.4		13.0		15.5	
4.5 to 5.5	C _L = 15 pF		3.7	5.5		6.5		8.0			
	C _L = 50 pF		4.4	7.5		8.5		10.0			
C _{IN}	Input Capacitance			5.5	10		10		10.0	pF	
C _{PD}	Power Dissipation Capacitance (Note 3)	5.0		11						pF	

3. C_{PD} is defined as the value of the internal equivalent capacitance which is calculated from the dynamic operating current consumption without load. Average operating current can be obtained by the equation I_{CC(OPR)} = C_{PD} • V_{CC} • f_{in} + I_{CC}. C_{PD} is used to determine the no-load dynamic power consumption: P_D = C_{PD} • V_{CC}² • f_{in} + I_{CC} • V_{CC}.

NLU1GT32

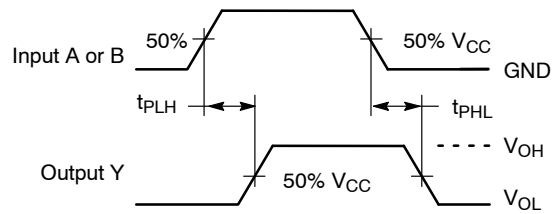
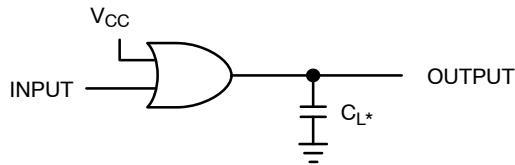

Figure 3. Switching Waveforms



*Includes all probe and jig capacitance.
A 1-MHz square input wave is recommended for propagation delay tests.

Figure 4. Test Circuit

ORDERING INFORMATION

Device	Package	Shipping†
NLU1GT32MUTCG	UDFN6, 1.2 x 1.0, 0.4P (Pb-Free)	3000 / Tape & Reel
NLU1GT32AMUTCG	UDFN6, 1.45 x 1.0, 0.5P (Pb-Free)	3000 / Tape & Reel
NLU1GT32CMUTCG	UDFN6, 1.0 x 1.0, 0.35P (Pb-Free)	3000 / Tape & Reel

†For information on tape and reel specifications, including part orientation and tape sizes, please refer to our Tape and Reel Packaging Specifications Brochure, BRD8011/D.

NLU1GT32

PACKAGE DIMENSIONS

UDFN6, 1.2x1.0, 0.4P
CASE 517AA
ISSUE D

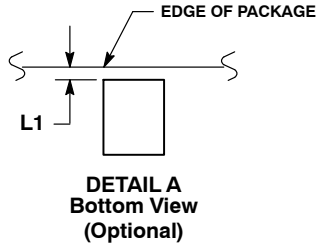
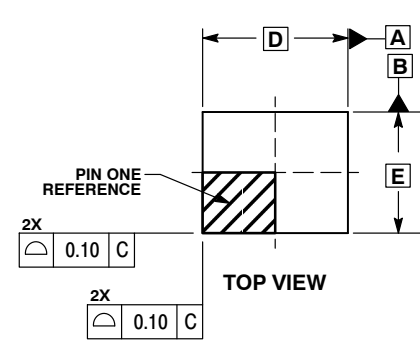

- NOTES:
1. DIMENSIONING AND TOLERANCING PER ASME Y14.5M, 1994.
 2. CONTROLLING DIMENSION: MILLIMETERS.
 3. DIMENSION b APPLIES TO PLATED TERMINAL AND IS MEASURED BETWEEN 0.25 AND 0.30 mm FROM TERMINAL.
 4. COPLANARITY APPLIES TO THE EXPOSED PAD AS WELL AS THE TERMINALS.

MILLIMETERS		
DIM	MIN	MAX
A	0.45	0.55
A1	0.00	0.05
A3	0.127	REF
b	0.15	0.25
D	1.20	BSC
E	1.00	BSC
e	0.40	BSC
L	0.30	0.40
L1	0.00	0.15
L2	0.40	0.50

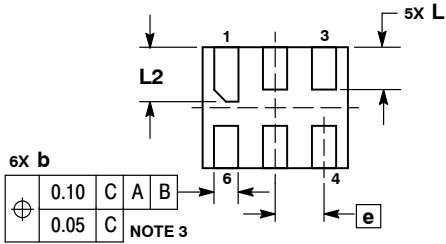
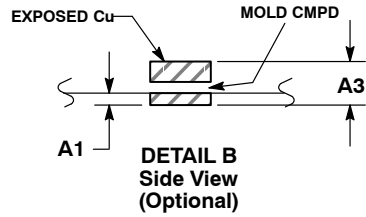
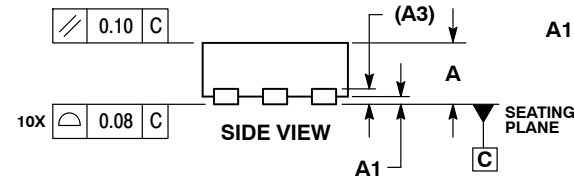

MOUNTING FOOTPRINT*

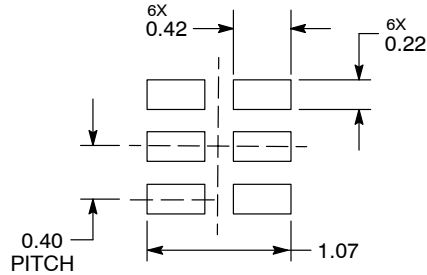

DIMENSIONS: MILLIMETERS

*For additional information on our Pb-Free strategy and soldering details, please download the ON Semiconductor Soldering and Mounting Techniques Reference Manual, SOLDERRM/D.

NLU1GT32

PACKAGE DIMENSIONS

UDFN6 1.45x1.0, 0.5P
CASE 517AQ
ISSUE O

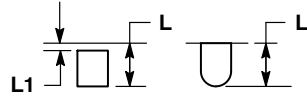
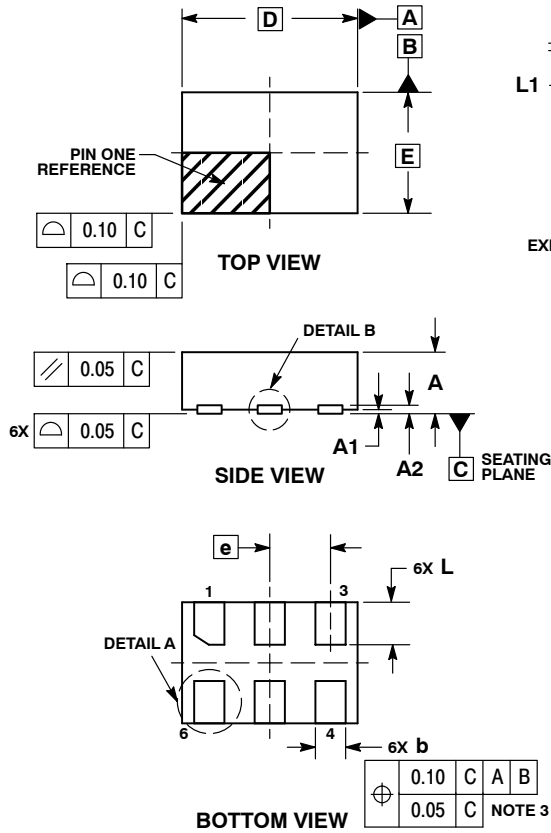

DETAIL A
OPTIONAL
CONSTRUCTIONS

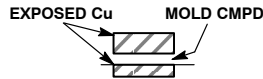

DETAIL B
OPTIONAL
CONSTRUCTIONS

NOTES:

1. DIMENSIONING AND TOLERANCING PER ASME Y14.5M, 1994.
2. CONTROLLING DIMENSION: MILLIMETERS.
3. DIMENSION b APPLIES TO PLATED TERMINAL AND IS MEASURED BETWEEN 0.15 AND 0.30 mm FROM THE TERMINAL TIP.

DIM	MILLIMETERS	
	MIN	MAX
A	0.45	0.55
A1	0.00	0.05
A2	0.07 REF	
b	0.20	0.30
D	1.45 BSC	
E	1.00 BSC	
e	0.50 BSC	
L	0.30	0.40
L1	---	0.15

MOUNTING FOOTPRINT

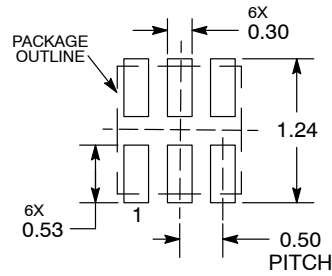

DIMENSIONS: MILLIMETERS

*For additional information on our Pb-Free strategy and soldering details, please download the ON Semiconductor Soldering and Mounting Techniques Reference Manual, SOLDERRM/D.

NLU1GT32

PACKAGE DIMENSIONS

UDFN6 1.0x1.0, 0.35P
CASE 517BX
ISSUE O

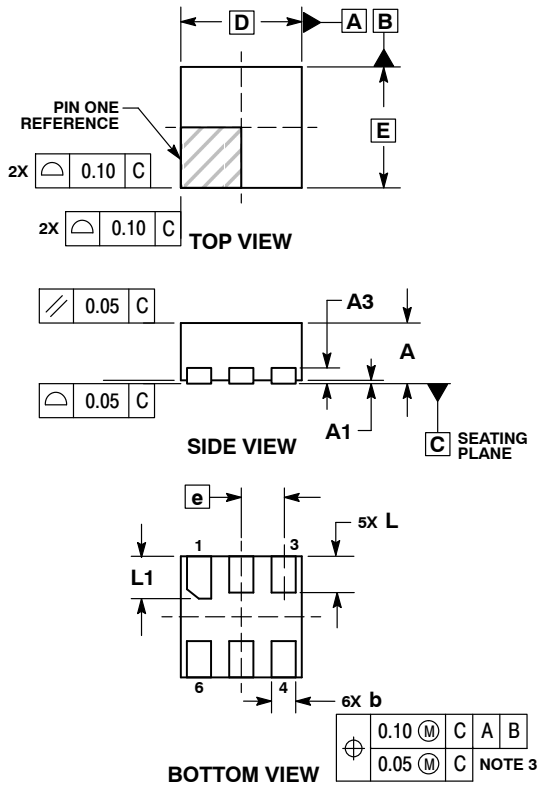

NOTES:

1. DIMENSIONING AND TOLERANCING PER ASME Y14.5M, 1994.
2. CONTROLLING DIMENSION: MILLIMETERS.
3. DIMENSION b APPLIES TO PLATED TERMINAL AND IS MEASURED BETWEEN 0.15 AND 0.20 MM FROM TERMINAL TIP.
4. PACKAGE DIMENSIONS EXCLUSIVE OF BURRS AND MOLD FLASH.

MILLIMETERS		
DIM	MIN	MAX
A	0.45	0.55
A1	0.00	0.05
A3	0.13 REF	
b	0.12	0.22
D	1.00 BSC	
E	1.00 BSC	
e	0.35 BSC	
L	0.25	0.35
L1	0.30	0.40

RECOMMENDED SOLDERING FOOTPRINT*

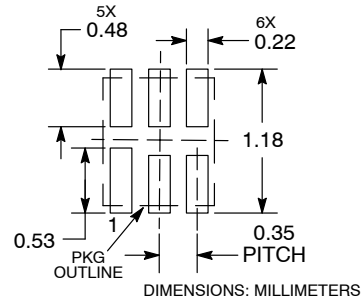

*For additional information on our Pb-Free strategy and soldering details, please download the ON Semiconductor Soldering and Mounting Techniques Reference Manual, SOLDERRM/D.

MiniGate is a trademark of Semiconductor Components Industries, LLC (SCILLC).

ON Semiconductor and are trademarks of Semiconductor Components Industries, LLC dba ON Semiconductor or its subsidiaries in the United States and/or other countries. ON Semiconductor owns the rights to a number of patents, trademarks, copyrights, trade secrets, and other intellectual property. A listing of ON Semiconductor's product/patent coverage may be accessed at www.onsemi.com/site/pdf/Patent-Marking.pdf. ON Semiconductor reserves the right to make changes without further notice to any products herein. ON Semiconductor makes no warranty, representation or guarantee regarding the suitability of its products for any particular purpose, nor does ON Semiconductor assume any liability arising out of the application or use of any product or circuit, and specifically disclaims any and all liability, including without limitation special, consequential or incidental damages. Buyer is responsible for its products and applications using ON Semiconductor products, including compliance with all laws, regulations and safety requirements or standards, regardless of any support or applications information provided by ON Semiconductor. "Typical" parameters which may be provided in ON Semiconductor data sheets and/or specifications can and do vary in different applications and actual performance may vary over time. All operating parameters, including "Typicals" must be validated for each customer application by customer's technical experts. ON Semiconductor does not convey any license under its patent rights nor the rights of others. ON Semiconductor products are not designed, intended, or authorized for use as a critical component in life support systems or any FDA Class 3 medical devices or medical devices with a same or similar classification in a foreign jurisdiction or any devices intended for implantation in the human body. Should Buyer purchase or use ON Semiconductor products for any such unintended or unauthorized application, Buyer shall indemnify and hold ON Semiconductor and its officers, employees, subsidiaries, affiliates, and distributors harmless against all claims, costs, damages, and expenses, and reasonable attorney fees arising out of, directly or indirectly, any claim of personal injury or death associated with such unintended or unauthorized use, even if such claim alleges that ON Semiconductor was negligent regarding the design or manufacture of the part. ON Semiconductor is an Equal Opportunity/Affirmative Action Employer. This literature is subject to all applicable copyright laws and is not for resale in any manner.

PUBLICATION ORDERING INFORMATION

LITERATURE FULFILLMENT:
Literature Distribution Center for ON Semiconductor
19521 E. 32nd Pkwy, Aurora, Colorado 80011 USA
Phone: 303-675-2175 or 800-344-3860 Toll Free USA/Canada
Fax: 303-675-2176 or 800-344-3867 Toll Free USA/Canada
Email: orderlit@onsemi.com

N. American Technical Support: 800-282-9855 Toll Free USA/Canada
Europe, Middle East and Africa Technical Support:
Phone: 421 33 790 2910
Japan Customer Focus Center
Phone: 81-3-5817-1050

ON Semiconductor Website: www.onsemi.com
Order Literature: <http://www.onsemi.com/orderlit>

For additional information, please contact your local Sales Representative

Mouser Electronics

Authorized Distributor

Click to View Pricing, Inventory, Delivery & Lifecycle Information:

[ON Semiconductor:](#)

[NLU1GT32MUTCG](#) [NLU1GT32AMUTCG](#)