

# NCP4641

## 150 mA, Wide Input Range, Voltage Regulator

The NCP4641 is a CMOS 150 mA linear voltage regulator with high input voltage and ultra-low supply current. It incorporates multiple protection features such as peak current limit, short circuit current limit and thermal shutdown to ensure a very robust device.

A high maximum input voltage tolerance of 50 V and a wide temperature range make the NCP4641 suitable for a variety of demanding applications.

### Features

- Operating Input Voltage Range: 4 V to 36 V
- Output Voltage Range: 2.0 to 12.0 V (0.1 steps)
- $\pm 2\%$  Output Voltage Accuracy
- Output Current: min 150 mA ( $V_{IN} = 8\text{ V}$ ,  $V_{OUT} = 5\text{ V}$ )
- Line Regulation: 0.05%/V
- Peak Current Limit Circuit
- Short Current Limit Circuit
- Thermal Shutdown Circuit
- Available in SOT-89-5 and SOIC6-TL Package
- These are Pb-Free Devices

### Typical Applications

- Power source for home appliances
- Power source for car audio equipment, navigation system
- Power source for notebooks, digital TVs, cordless phones and private LAN systems
- Power source for office equipment machines such as copiers, printers, facsimiles, scanners, projectors, etc.

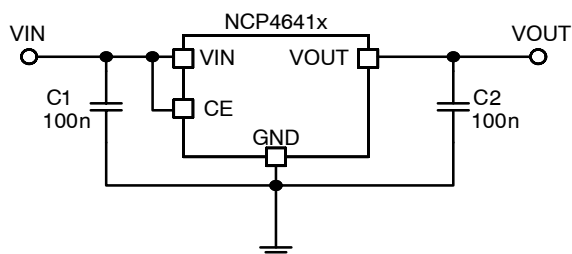

Figure 1. Typical Application Schematic



ON Semiconductor™

[www.onsemi.com](http://www.onsemi.com)

### MARKING DIAGRAMS

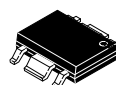

SOIC6-TL  
CASE 751BR

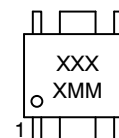

SOT-89 5  
CASE 528AB

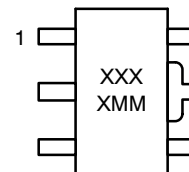

XXXX = Specific Device Code  
MM = Date Code

(Note: Microdot may be in either location)

### ORDERING INFORMATION

See detailed ordering and shipping information on page 12 of this data sheet.

# NCP4641

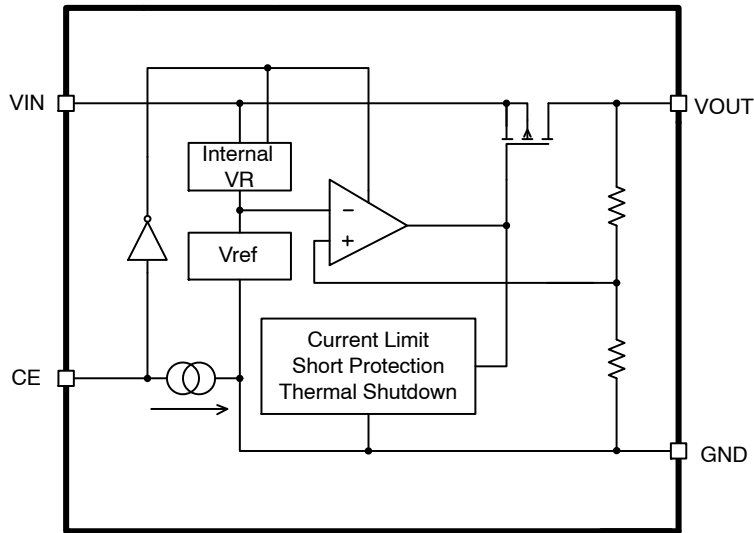

Figure 2. Simplified Schematic Block Diagram

## PIN FUNCTION DESCRIPTION

Pin No. SOT89	Pin No. SOIC6-TL	Pin Name	Description
5	6	VIN	Input pin
2	2	GND	Ground pin, all ground pins must be connected together when it is mounted on board
4	4	GND	Ground pin, all ground pins must be connected together when it is mounted on board
-	5	GND	Ground pin, all ground pins must be connected together when it is mounted on board
3	3	CE	Chip enable pin ("H" active)
1	1	VOUT	Output pin

# NCP4641

## ABSOLUTE MAXIMUM RATINGS

Rating	Symbol	Value	Unit
Input Voltage	$V_{IN}$	-0.3 to 50	V
Peak Input Voltage (Note 1)	$V_{IN}$	60	V
Output Voltage	$V_{OUT}$	-0.3 to $V_{IN} + 0.3 \leq 50$	V
Chip Enable Input	$V_{CE}$	-0.3 to $V_{IN} + 0.3 \leq 50$	V
Output Current	$I_{OUT}$	250	mA
Power Dissipation SOT-89	$P_D$	900	mW
Power Dissipation SOIC6-TL		1700	
Junction Temperature	$T_J$	-40 to 150	°C
Storage Temperature	$T_{STG}$	-55 to 125	°C
ESD Capability, Human Body Model (Note 2)	$ESD_{HBM}$	2000	V
ESD Capability, Machine Model (Note 2)	$ESD_{MM}$	200	V

Stresses exceeding those listed in the Maximum Ratings table may damage the device. If any of these limits are exceeded, device functionality should not be assumed, damage may occur and reliability may be affected.

1. Duration time = 200 ms

2. This device series incorporates ESD protection and is tested by the following methods:

ESD Human Body Model tested per AEC-Q100-002 (EIA/JESD22-A114)

ESD Machine Model tested per AEC-Q100-003 (EIA/JESD22-A115)

Latchup Current Maximum Rating tested per JEDEC standard: JESD78.

## THERMAL CHARACTERISTICS

Rating	Symbol	Value	Unit
Thermal Characteristics, SOT-89 Thermal Resistance, Junction-to-Air	$R_{\theta JA}$	111	°C/W
Thermal Characteristics, SOIC6-TL Thermal Resistance, Junction-to-Air	$R_{\theta JA}$	59	°C/W

# NCP4641

## ELECTRICAL CHARACTERISTICS $T_A = 25^\circ\text{C}$

Parameter	Test Conditions	Symbol	Min	Typ	Max	Unit	
Operating Input Voltage		$V_{IN}$	4		36	V	
Output Voltage	$V_{IN} = V_{OUT} + 3\text{ V}$ , $I_{OUT} = 1\text{ mA}$	$V_{OUT}$	x0.98		x1.02	V	
Output Voltage Temp. Coefficient	$V_{IN} = V_{OUT} + 3\text{ V}$ , $I_{OUT} = 1\text{ mA}$ , $T_A = -40$ to $105^\circ\text{C}$			$\pm 100$		ppm/ $^\circ\text{C}$	
Line Regulation	$V_{IN} = V_{OUT} + 1.5\text{ V}$ to $36\text{ V}$ , $I_{OUT} = 1\text{ mA}$	$Line_{Reg}$		0.05	0.20	%/V	
Load Regulation	$V_{IN} = V_{OUT} + 3\text{ V}$ , $I_{OUT} = 1\text{ mA}$ to $40\text{ mA}$	$Load_{Reg}$			10	25	mV
					20	35	
Dropout Voltage	$I_{OUT} = 20\text{ mA}$	$V_{DO}$			(Note 3)	V	
					0.35	0.60	
					0.25	0.40	
					0.20	0.35	
Output Current	$V_{IN} = V_{OUT} + 3\text{ V}$	$I_{OUT}$	100			mA	
			120				
			150				
Short Current Limit	$V_{OUT} = 0\text{ V}$	$I_{SC}$		50		mA	
Quiescent Current	$V_{IN} = V_{OUT} + 3\text{ V}$ , $I_{OUT} = 0\text{ mA}$	$I_Q$		9	20	$\mu\text{A}$	
Standby Current	$V_{IN} = 36\text{ V}$ , $V_{CE} = 0\text{ V}$	$I_{STB}$		0.1	1	$\mu\text{A}$	
CE Pin Threshold Voltage	CE Input Voltage "H"	$V_{CEH}$	1.5			V	
	CE Input Voltage "L"	$V_{CEL}$			0.3		
Thermal Shutdown Temperature		$T_{SD}$		150		$^\circ\text{C}$	
Thermal Shutdown Release Temperature		$T_{SR}$		125		$^\circ\text{C}$	
Power Supply Rejection Ratio	$V_{IN} = 6\text{ V}$ , $V_{OUT} = 3.0\text{ V}$ , $I_{OUT} = 30\text{ mA}$ , $f = 1\text{ kHz}$	PSRR		27		dB	
Output Noise Voltage	$V_{OUT} = 3.0\text{ V}$ , $I_{OUT} = 30\text{ mA}$ , $f = 10\text{ Hz}$ to $100\text{ kHz}$	$V_N$		112		$\mu\text{V}_{rms}$	

Product parametric performance is indicated in the Electrical Characteristics for the listed test conditions, unless otherwise noted. Product performance may not be indicated by the Electrical Characteristics if operated under different conditions.

3. Dropout voltage for  $2.0\text{ V} \leq V_{OUT} < 3.7\text{ V}$  can be computed by this formula:  $V_{DO} = 4\text{ V} - V_{OUTSET}$

TYPICAL CHARACTERISTICS

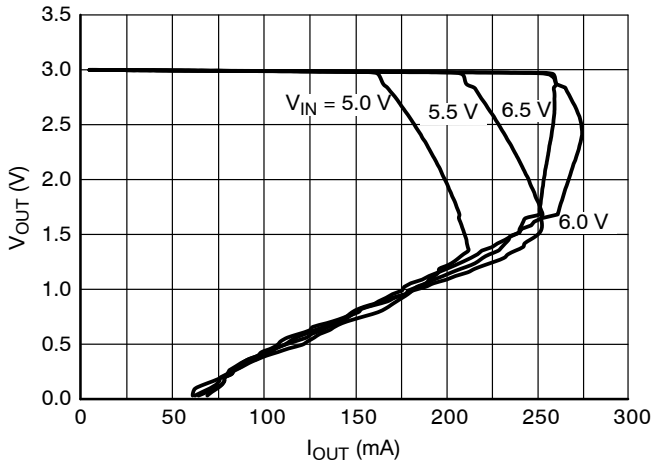

Figure 3. Output Voltage vs. Output Current  
3.0 V Version ( $T_J = 25^\circ\text{C}$ )

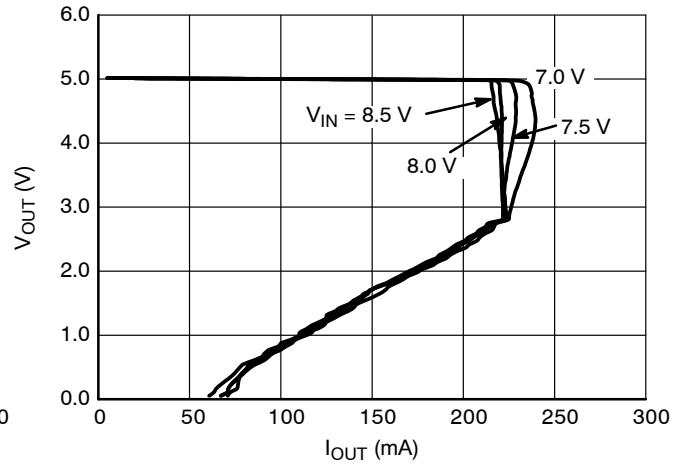

Figure 4. Output Voltage vs. Output Current  
5.0 V Version ( $T_J = 25^\circ\text{C}$ )

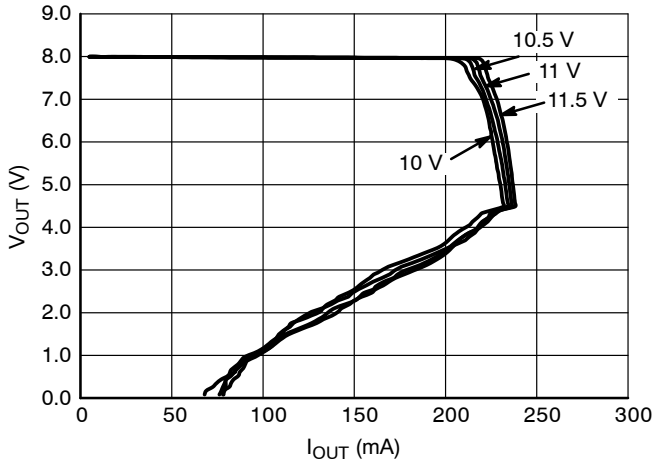

Figure 5. Output Voltage vs. Output Current  
8.0 V Version ( $T_J = 25^\circ\text{C}$ )

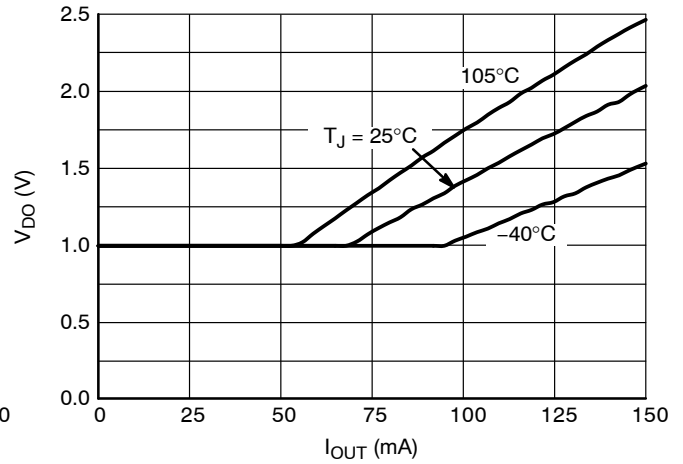

Figure 6. Dropout Voltage vs. Output Current  
3.0 V Version

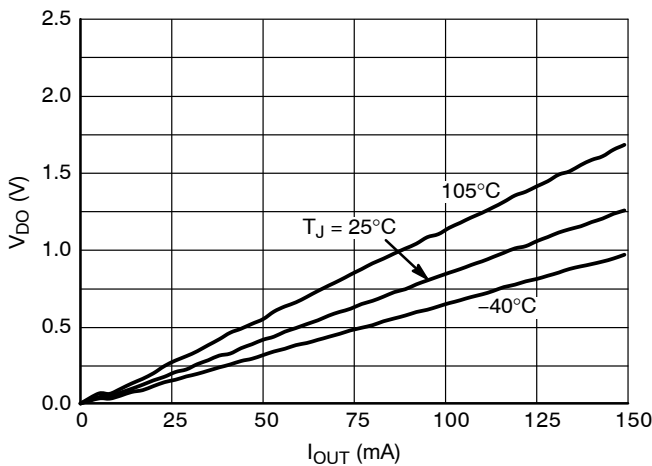

Figure 7. Dropout Voltage vs. Output Current  
5.0 V Version

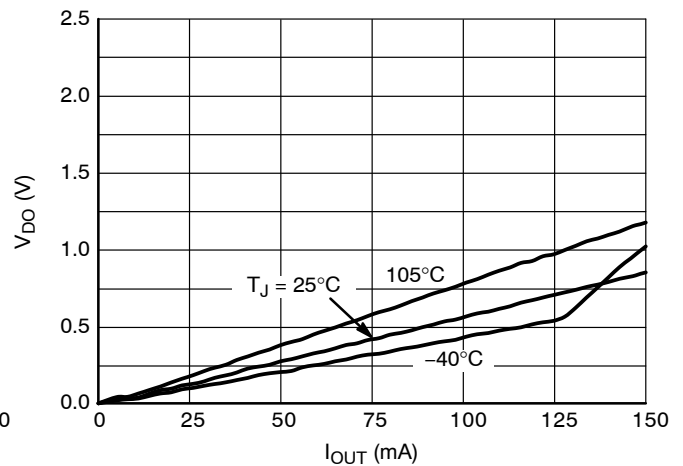

Figure 8. Dropout Voltage vs. Output Current  
8.0 V Version

TYPICAL CHARACTERISTICS

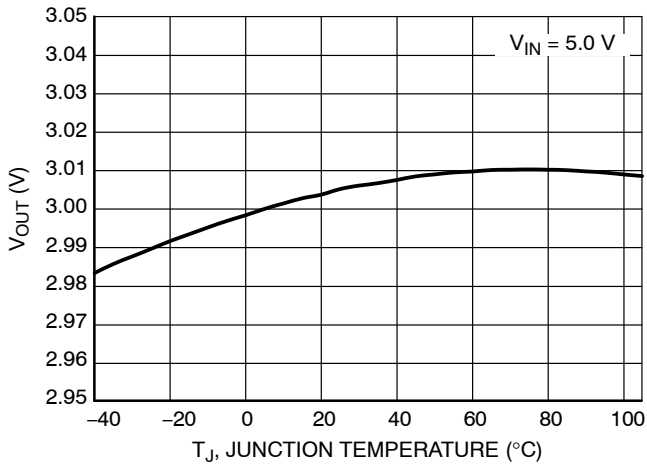

Figure 9. Output Voltage vs. Temperature, 3.0 V Version

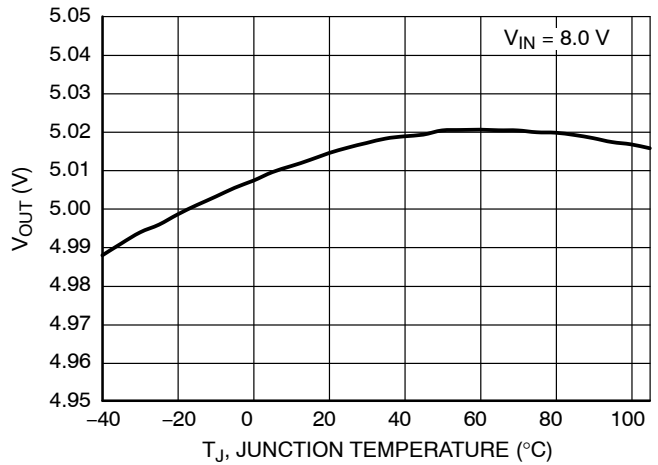

Figure 10. Output Voltage vs. Temperature, 5.0 V Version

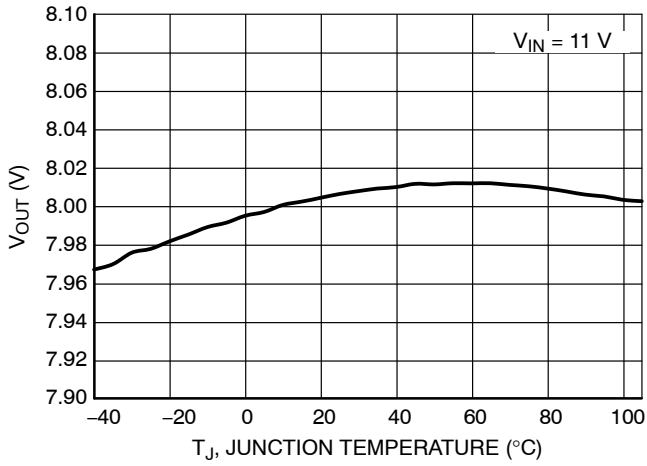

Figure 11. Output Voltage vs. Temperature, 8.0 V Version

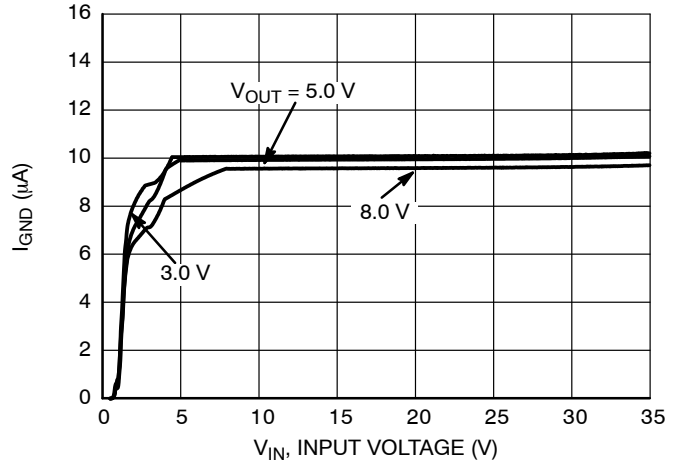

Figure 12. Supply Current vs. Input Voltage

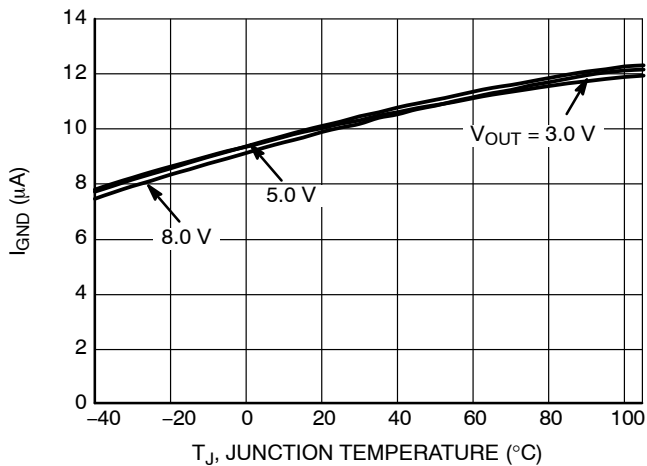

Figure 13. Supply Current vs. Temperature

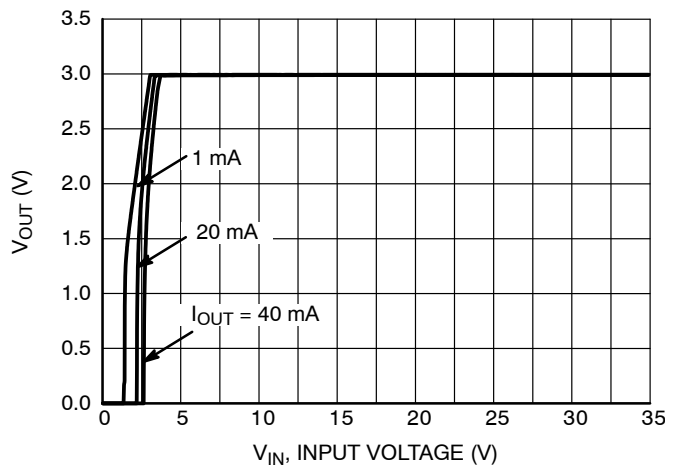

Figure 14. Output Voltage vs. Input Voltage, 3.0 V Version

# NCP4641

## TYPICAL CHARACTERISTICS

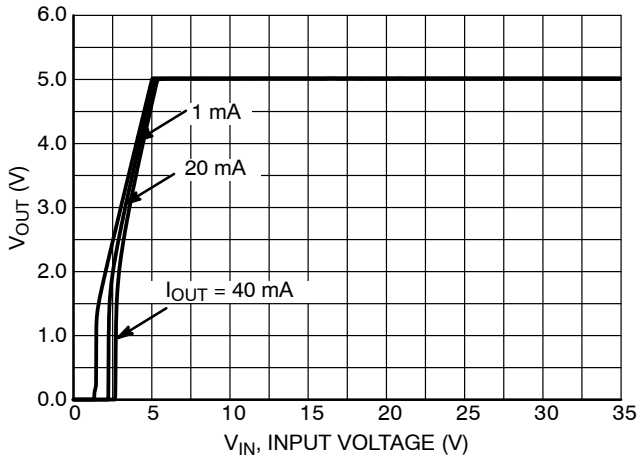

Figure 15. Output Voltage vs. Input Voltage, 5.0 V Version

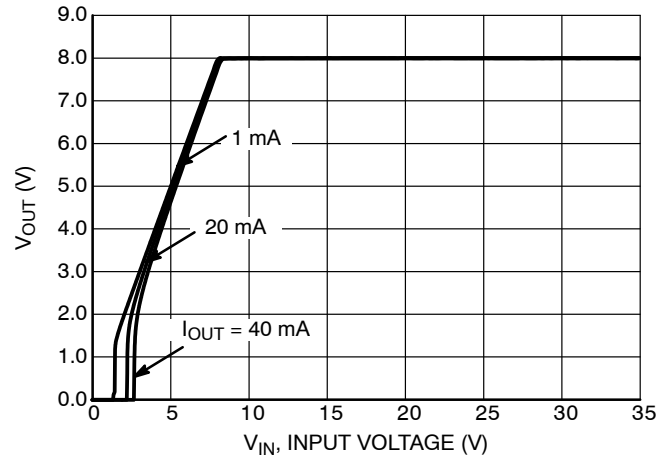

Figure 16. Output Voltage vs. Input Voltage, 8.0 V Version

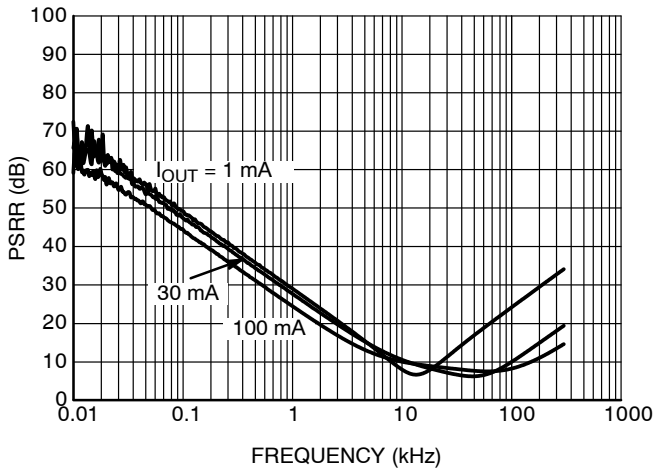

Figure 17. PSRR, 3.0 V Version,  $V_{IN} = 6.0 V$

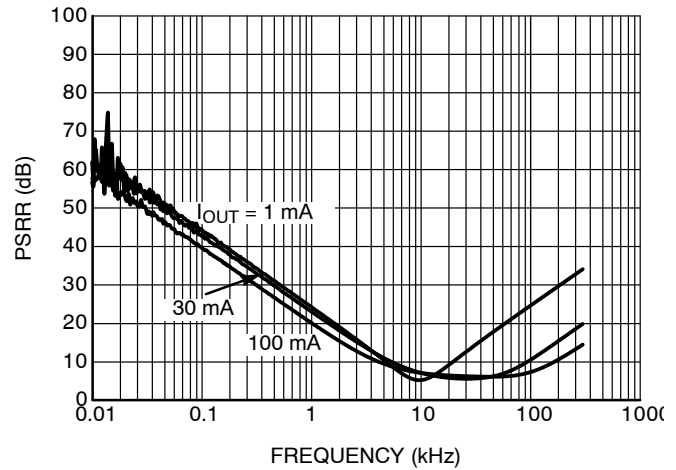

Figure 18. PSRR, 5.0 V Version,  $V_{IN} = 8.0 V$

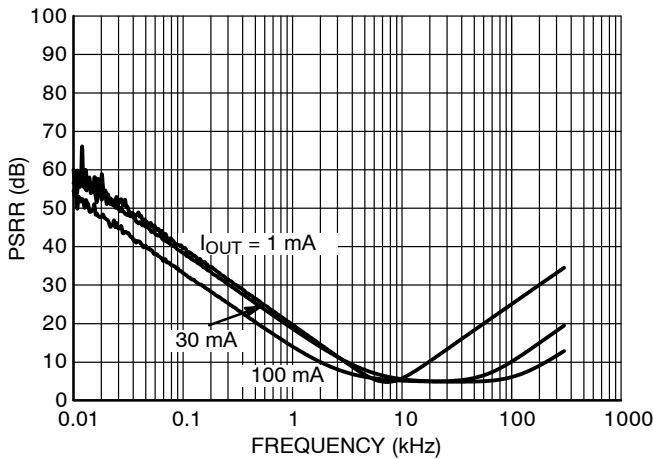

Figure 19. PSRR, 8.0 V Version,  $V_{IN} = 11 V$

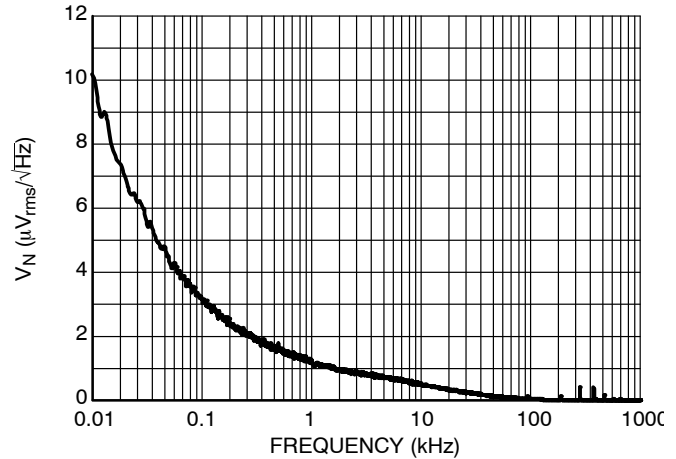

Figure 20. Output Voltage Noise, 3.0 V Version,  $V_{IN} = 6.0 V$ ,  $I_{OUT} = 30 mA$

TYPICAL CHARACTERISTICS

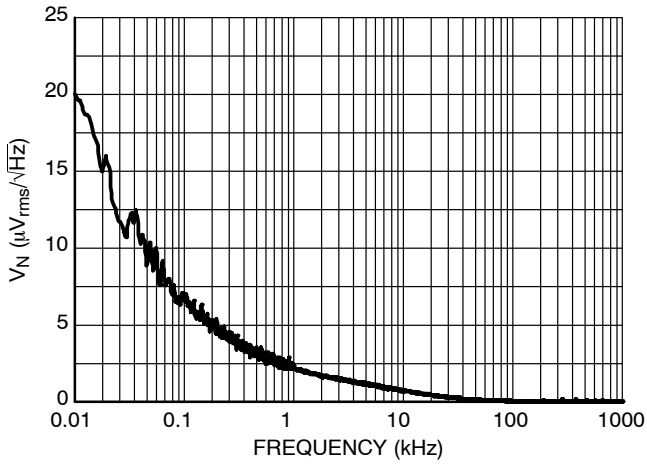

Figure 21. Output Voltage Noise, 5.0 V Version,  
 $V_{IN} = 8.0\text{ V}$ ,  $I_{OUT} = 30\text{ mA}$

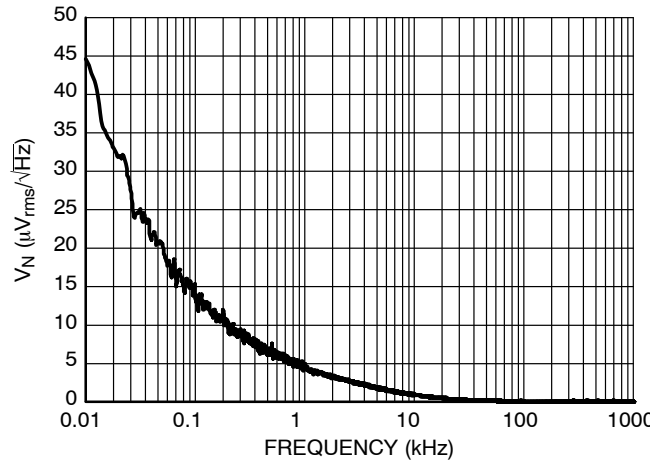

Figure 22. Output Voltage Noise, 8.0 V version,  
 $V_{IN} = 11.0\text{ V}$ ,  $I_{OUT} = 30\text{ mA}$

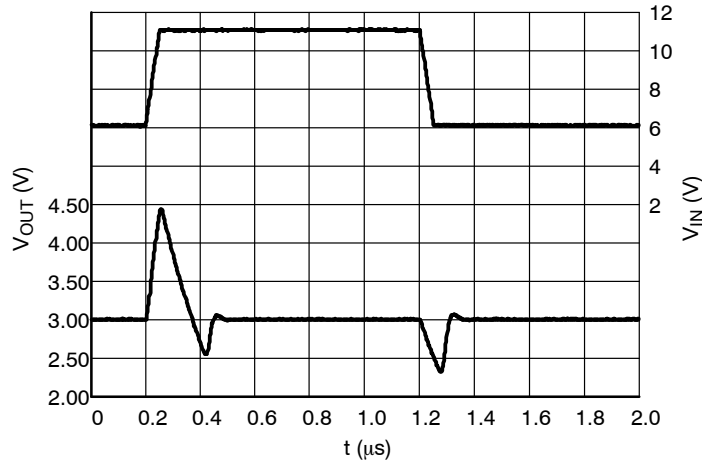

Figure 23. Line Transients, 3.0 V Version,  
 $t_R = t_F = 5\text{ }\mu\text{s}$ ,  $I_{OUT} = 1\text{ mA}$

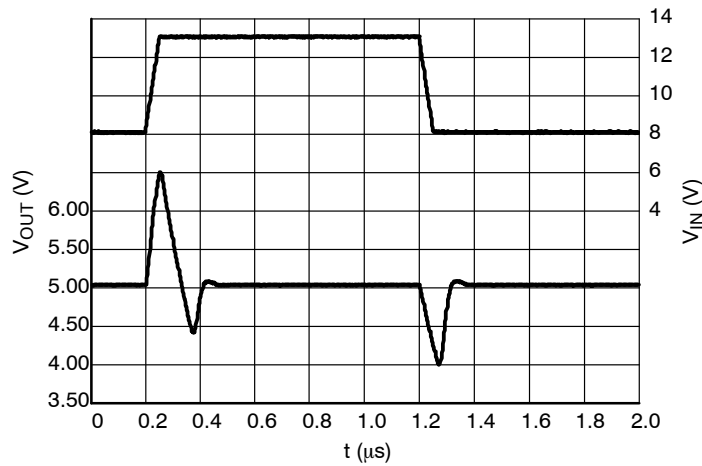
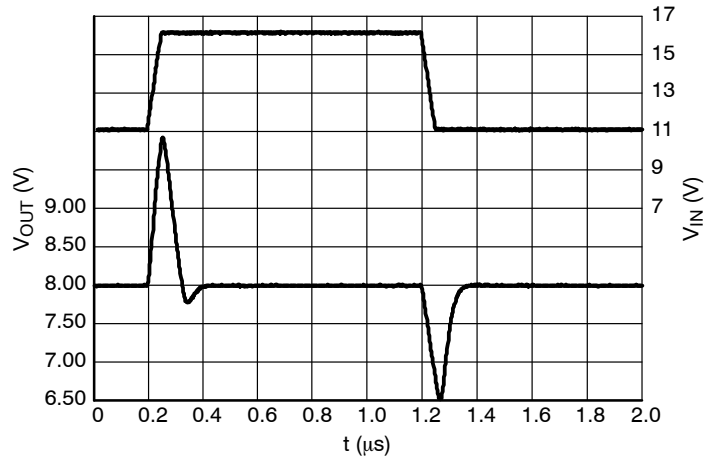

Figure 24. Line Transients, 5.0 V Version,  
 $t_R = t_F = 5\text{ }\mu\text{s}$ ,  $I_{OUT} = 1\text{ mA}$



# NCP4641

## TYPICAL CHARACTERISTICS



**Figure 25. Line Transients, 8.0 V Version,  
 $t_R = t_F = 5 \mu\text{s}$ ,  $I_{OUT} = 1 \text{ mA}$**

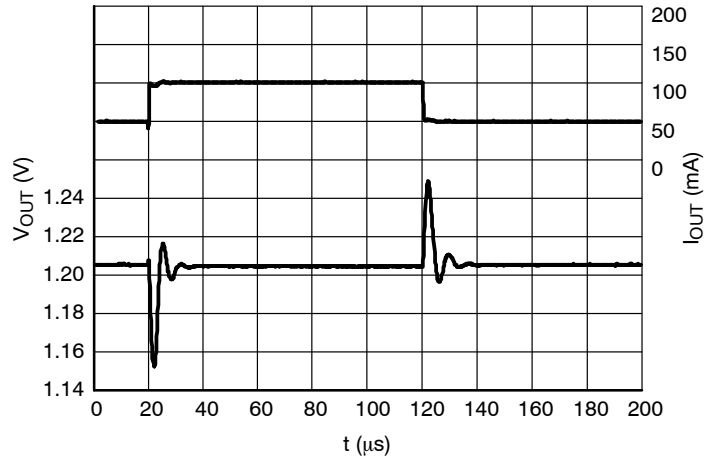

**Figure 26. Load Transients, 3.0 V Version,  
 $I_{OUT} = 1 - 20 \text{ mA}$ ,  $t_R = t_F = 50 \mu\text{s}$ ,  $V_{IN} = 6.0 \text{ V}$**

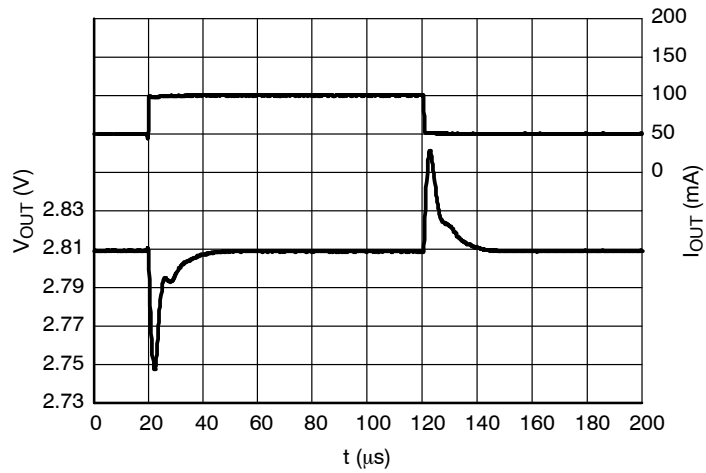

**Figure 27. Load Transients, 5.0 V Version,  
 $I_{OUT} = 1 - 20 \text{ mA}$ ,  $t_R = t_F = 50 \mu\text{s}$ ,  $V_{IN} = 8.0 \text{ V}$**

# NCP4641

## TYPICAL CHARACTERISTICS

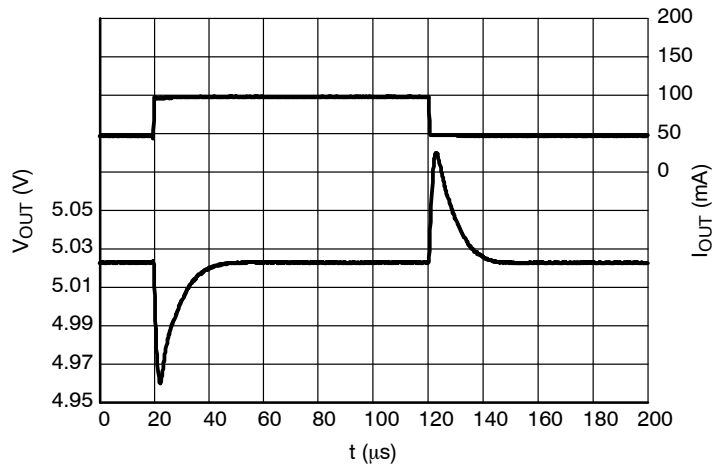

Figure 28. Load Transients, 8.0 V Version,  
 $I_{OUT} = 1 - 20$  mA,  $t_R = t_F = 50$   $\mu$ s,  $V_{IN} = 11.0$  V

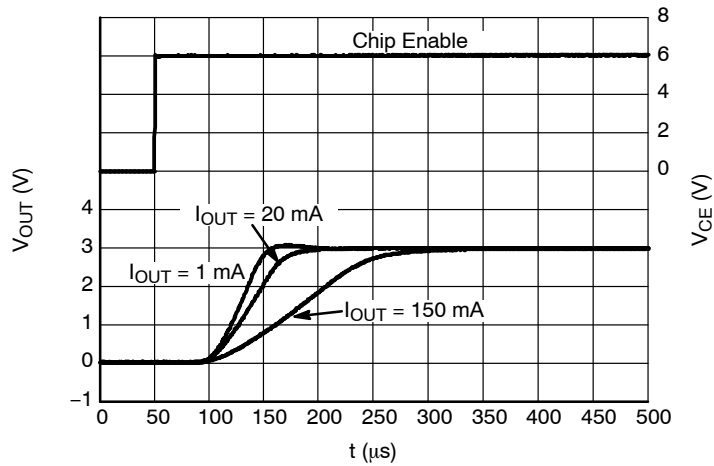

Figure 29. Start-up, 3.0 V Version,  $V_{IN} = 6.0$  V

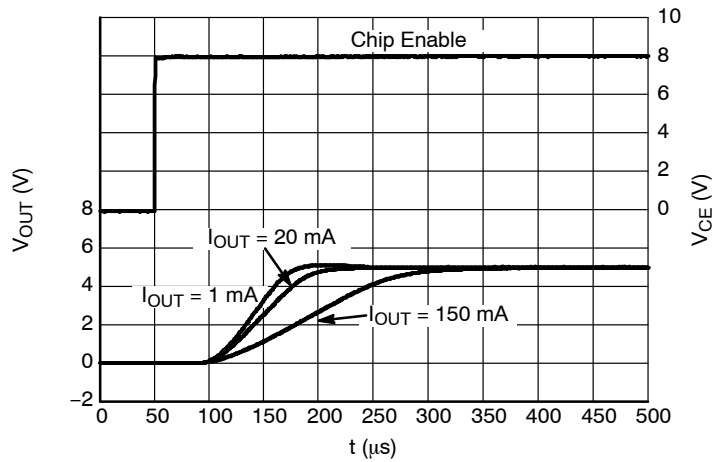

Figure 30. Start-up, 5.0 V Version,  $V_{IN} = 8.0$  V

# NCP4641

## TYPICAL CHARACTERISTICS

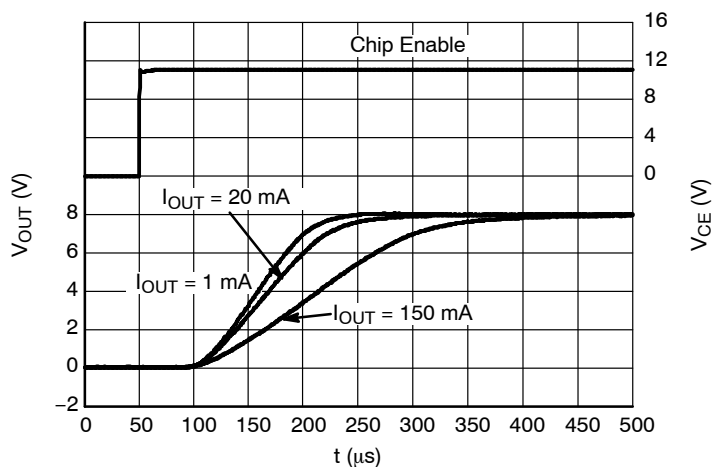

Figure 31. Start-up, 8.0 V Version,  $V_{IN} = 11.0 \text{ V}$

APPLICATION INFORMATION

A typical application circuit for NCP4641 series is shown in Figure 32.

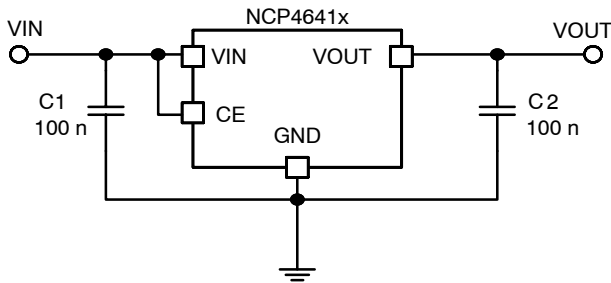

Figure 32. Typical Application Schematic

**Input Decoupling Capacitor (C1)**

The device is stable without any input capacitance, but if input line is long and has high impedance or if more stable operation is needed, input capacitor C1 should be connected as close as possible to the IC. Recommended range of input capacitor value is 100 nF to 10 μF.

**Output Decoupling Capacitor (C2)**

The NCP4641 can work stable without output capacitor, but if faster response and higher stability reserve is needed, output capacitor should be connected as close as possible to the device. Recommended range of output capacitance is 100 nF to 10 μF. Larger values of output capacitance and lower ESR improves dynamic parameters.

**Enable Operation**

The enable pin CE may be used for turning the regulator on and off. The device is activated when high level is

connected to CE pin. Do not keep CE pin not connected or between VCEH and VCEL voltage levels. Otherwise output voltage would be unstable or indefinite and unexpected would flow internally.

**Thermal**

As a power across the IC increase, it might become necessary to provide some thermal relief. The maximum power dissipation supported by the device is dependent upon board design and layout. Mounting pad configuration on the PCB, the board material, and also the ambient temperature affect the rate of temperature increase for the part. When the device has good thermal conductivity through the PCB the junction temperature will be relatively low in high power dissipation applications.

The IC includes internal thermal shutdown circuit that stops operation of regulator, if junction temperature is higher than 150°C. After that, when junction temperature decreases below 125°C, the operation of voltage regulator would restart. While high power dissipation condition is, the regulator starts and stops repeatedly and protects itself against overheating.

**PCB Layout**

Pins number 2 and 4 of SOT89-5 package and pins number 2, 4 and 5 of SOIC6-TL must be wired to the GND plane while it is mounted on board. Make VIN and GND lines sufficient. If their impedance is high, noise pickup or unstable operation may result. Connect capacitors C1 and C2 as close as possible to the IC, and make wiring as short as possible.

ORDERING INFORMATION

Device	Nominal Output Voltage	Description	Marking	Package	Shipping <sup>†</sup>
NCP4641H030T1G	3.0 V	Enable High	M030	SOT89-5 (Pb-Free)	1000 / Tape & Reel
NCP4641H033T1G	3.3 V	Enable High	M033	SOT-89-5 (Pb-Free)	1000 / Tape & Reel
NCP4641H050T1G	5.0 V	Enable High	M050	SOT89-5 (Pb-Free)	1000 / Tape & Reel
NCP4641H080T1G	8.0 V	Enable High	M080	SOT89-5 (Pb-Free)	1000 / Tape & Reel

<sup>†</sup>For information on tape and reel specifications, including part orientation and tape sizes, please refer to our Tape and Reel Packaging Specifications Brochure, BRD8011/D.

\*To order other package and voltage variants, please contact your ON Semiconductor sales representative.

# NCP4641

## PACKAGE DIMENSIONS

### SOIC6 (HSOP6) CASE 751BR ISSUE A

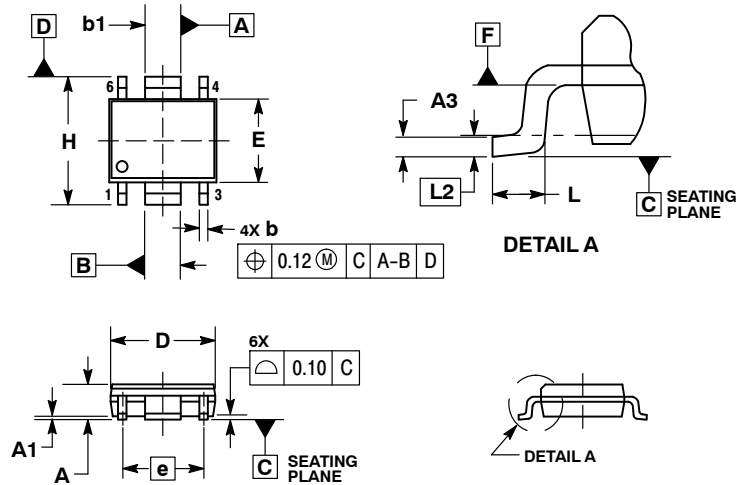

#### NOTES:

1. DIMENSIONING AND TOLERANCING PER ASME Y14.5M, 1994.
2. CONTROLLING DIMENSION: MILLIMETERS
3. DIMENSION b AND b1 DO NOT INCLUDE DAMBAR PROTRUSION. ALLOWABLE PROTRUSION SHALL BE 0.10 mm IN EXCESS OF MAXIMUM MATERIAL CONDITION.
4. DIMENSIONS D AND E DO NOT INCLUDE MOLD FLASH, PROTRUSIONS, OR GATE BURRS. MOLD FLASH, PROTRUSIONS, OR GATE BURRS SHALL NOT EXCEED 0.15 mm PER SIDE. DIMENSIONS D AND E ARE DETERMINED AT DATUM F.
5. DATUMS A AND B ARE DETERMINED AT DATUM F.
6. A1 IS DEFINED AS THE VERTICAL DISTANCE FROM THE SEATING PLANE TO THE LOWEST POINT ON THE PACKAGE BODY.

DIM	MILLIMETERS	
	MIN	MAX
A	1.45	1.85
A1	0.05	0.25
A3	0.15	0.30
b	0.30	0.50
b1	1.57	1.77
D	4.72	5.32
E	3.70	4.10
e	3.81 BSC	
H	5.70	6.30
L	0.40	0.80
L2	0.25 BSC	

#### RECOMMENDED SOLDERING FOOTPRINT\*

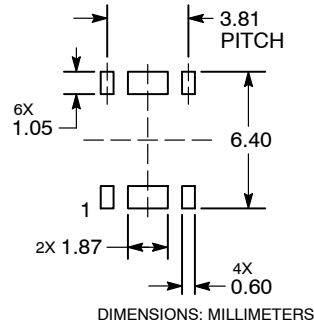

\*For additional information on our Pb-Free strategy and soldering details, please download the ON Semiconductor Soldering and Mounting Techniques Reference Manual, SOLDERRM/D.

# NCP4641

## PACKAGE DIMENSIONS

### SOT-89, 5 LEAD CASE 528AB ISSUE O

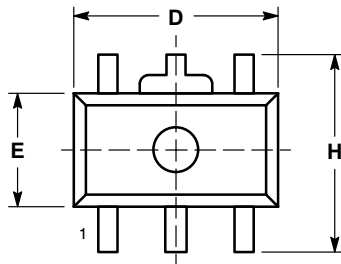

TOP VIEW

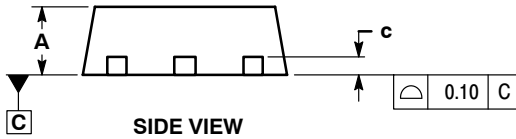

SIDE VIEW

NOTES:

1. DIMENSIONING AND TOLERANCING PER ASME Y14.5M, 1994.
2. CONTROLLING DIMENSION: MILLIMETERS.
3. LEAD THICKNESS INCLUDES LEAD FINISH.
4. DIMENSIONS D AND E DO NOT INCLUDE MOLD FLASH, PROTRUSIONS, OR GATE BURRS.
5. DIMENSIONS L, L2, L3, L4, L5, AND H ARE MEASURED AT DATUM PLANE C.

DIM	MILLIMETERS	
	MIN	MAX
A	1.40	1.60
b	0.32	0.52
b1	0.37	0.57
c	0.30	0.50
D	4.40	4.60
D2	1.40	1.80
E	2.40	2.60
e	1.40	1.60
H	4.25	4.45
L	1.10	1.50
L2	0.80	1.20
L3	0.95	1.35
L4	0.65	1.05
L5	0.20	0.60

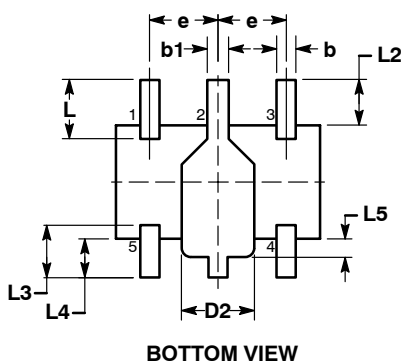

BOTTOM VIEW

### RECOMMENDED MOUNTING FOOTPRINT\*

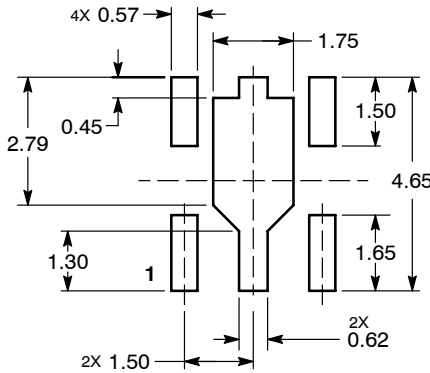

DIMENSIONS: MILLIMETERS

\*For additional information on our Pb-Free strategy and soldering details, please download the ON Semiconductor Soldering and Mounting Techniques Reference Manual, SOLDERRM/D.

ON Semiconductor and the  are registered trademarks of Semiconductor Components Industries, LLC (SCILLC) or its subsidiaries in the United States and/or other countries. SCILLC owns the rights to a number of patents, trademarks, copyrights, trade secrets, and other intellectual property. A listing of SCILLC's product/patent coverage may be accessed at [www.onsemi.com/site/pdf/Patent-Marking.pdf](http://www.onsemi.com/site/pdf/Patent-Marking.pdf). SCILLC reserves the right to make changes without further notice to any products herein. SCILLC makes no warranty, representation or guarantee regarding the suitability of its products for any particular purpose, nor does SCILLC assume any liability arising out of the application or use of any product or circuit, and specifically disclaims any and all liability, including without limitation special, consequential or incidental damages. "Typical" parameters which may be provided in SCILLC data sheets and/or specifications can and do vary in different applications and actual performance may vary over time. All operating parameters, including "Typicals" must be validated for each customer application by customer's technical experts. SCILLC does not convey any license under its patent rights nor the rights of others. SCILLC products are not designed, intended, or authorized for use as components in systems intended for surgical implant into the body, or other applications intended to support or sustain life, or for any other application in which the failure of the SCILLC product could create a situation where personal injury or death may occur. Should Buyer purchase or use SCILLC products for any such unintended or unauthorized application, Buyer shall indemnify and hold SCILLC and its officers, employees, subsidiaries, affiliates, and distributors harmless against all claims, costs, damages, and expenses, and reasonable attorney fees arising out of, directly or indirectly, any claim of personal injury or death associated with such unintended or unauthorized use, even if such claim alleges that SCILLC was negligent regarding the design or manufacture of the part. SCILLC is an Equal Opportunity/Affirmative Action Employer. This literature is subject to all applicable copyright laws and is not for resale in any manner.

### PUBLICATION ORDERING INFORMATION

**LITERATURE FULFILLMENT:**

Literature Distribution Center for ON Semiconductor  
P.O. Box 5163, Denver, Colorado 80217 USA  
Phone: 303-675-2175 or 800-344-3860 Toll Free USA/Canada  
Fax: 303-675-2176 or 800-344-3867 Toll Free USA/Canada  
Email: [orderlit@onsemi.com](mailto:orderlit@onsemi.com)

**N. American Technical Support:** 800-282-9855 Toll Free  
USA/Canada  
**Europe, Middle East and Africa Technical Support:**  
Phone: 421 33 790 2910  
**Japan Customer Focus Center**  
Phone: 81-3-5817-1050

**ON Semiconductor Website:** [www.onsemi.com](http://www.onsemi.com)  
**Order Literature:** <http://www.onsemi.com/orderlit>

For additional information, please contact your local Sales Representative

# Mouser Electronics

Authorized Distributor

Click to View Pricing, Inventory, Delivery & Lifecycle Information:

[ON Semiconductor:](#)

[NCP4641H030T1G](#) [NCP4641H050T1G](#) [NCP4641H080T1G](#) [NCP4641H033T1G](#)