

**TELEDYNE
RELAYS**

A Teledyne Technologies Company

**CENTIGRID®
COMMERCIAL RELAYS
DPDT**

**SERIES
172**

SERIES DESIGNATION	RELAY TYPE
172	DPDT basic relay
172D	DPDT relay with internal diode for coil transient suppression

INTERNAL CONSTRUCTION

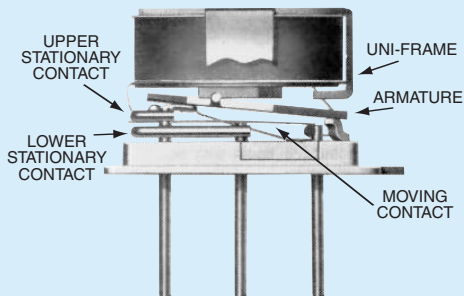

DESCRIPTION

The 172 Centigrad® relay is an ultraminiature, hermetically sealed, armature relay for commercial applications. Its low profile height (.280") and .100" grid spaced terminals, which preclude the need for spreader pads, make it an ideal choice where extreme packaging density and/or close PC board spacing are required.

The basic operating concept and internal structure are similar to Teledyne's DPDT 114 Centigrad® relay. Unique construction features and manufacturing techniques provide overall high reliability and excellent resistance to environmental extremes:

- All welded construction.
- Unique uni-frame design providing high magnetic efficiency and mechanical rigidity.
- High force/mass ratios for resistance to shock and vibration.
- Advanced cleaning techniques provide maximum assurance of internal cleanliness.
- Precious metal alloy contact material with gold plating assures excellent high current and dry circuit switching capabilities.

The Series 172 relay has an internal discrete silicon diode for coil transient suppression.

By virtue of its inherently low intercontact capacitance and contact circuit losses, the 172 relay is an excellent subminiature RF switch for frequencies well into the UHF spectrum (see Figure 1). Applications include telecommunications, test instruments, mobile communications, attenuators, and automatic test equipment.

ENVIRONMENTAL AND PHYSICAL SPECIFICATIONS		
Temperature (Ambient)	Storage	-65°C to +125°C
	Operating	-55°C to +85°C
Vibration (General Note 1)		10 g's to 500 Hz
Shock (General Note 1)		30 g's, 6 msec, half-sine
Enclosure		Hermetically sealed
Weight		0.15 oz. (4.3g) max.

SERIES 172
GENERAL ELECTRICAL SPECIFICATIONS (@25°C) (Notes 2 & 3)

Contact Arrangement	2 Form C (DPDT)
Rated Duty	Continuous
Contact Resistance	0.15 ohm max. before life; 0.3 ohm max. after life at 1A/28Vdc (measured 1/8" from header)
Contact Load Ratings (DC) (See Fig. 1 for other DC resistive voltage/current ratings)	Resistive: 1 Amp/28Vdc Inductive: 200 mA/28Vdc (320 mH) Lamp: 100 mA/28Vdc Low Level: 10 to 50 μA/10 to 50mV
Contact Life Ratings	5,000,000 cycles (typical) at low level 500,000 cycles (typical) at 0.5A/28Vdc resistive 100,000 cycles min. at all other loads specified above
Contact Overload Rating	2A/28Vdc Resistive (100 cycles min.)
Contact Carry Rating	Contact factory
Operate Time	6.0 msec max. at nominal rated coil voltage
Release Time	172: 3.0 msec max. 172D: 6.0 msec max.
Intercontact Capacitance	0.4 pf typical
Insulation Resistance	1,000 megohms min. between mutually isolated terminals
Dielectric Strength	Atmospheric pressure: 300 Vrms/60Hz
Negative Coil Transient 172	2.0 Vdc Max.
Diode P.I.V. 172D	60 Vdc Min.

DETAILED ELECTRICAL SPECIFICATIONS (@25°C) (Note 3)

BASE PART NUMBERS		172-3 172D-3	172-5 172D-5	172-12 172D-12	172-26 172D-26
Coil Voltage (Vdc)	Nom.	3.0	5.0	12.0	26.5
	Max.	3.6	5.8	16.0	32.0
Coil Resistance (Ohms ±20%)		39	64	400	1600
Pick-up Voltage (Vdc, Max.) Pulse Operation		2.25	3.8	9.0	18.0
Coil Operating Power at Nominal Voltage (Milliwatts)		235	405	360	440

OUTLINE DIMENSIONS (Note 4)

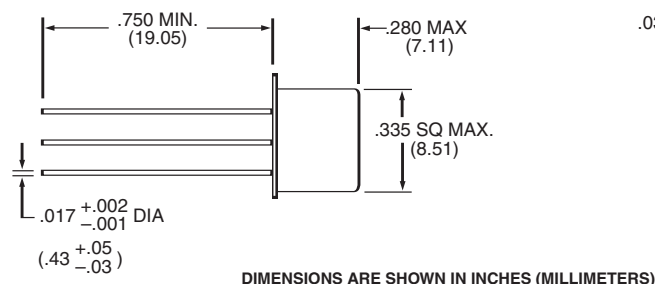

TERMINAL LOCATIONS
(Viewed from Terminals, Numbers for Reference Only)

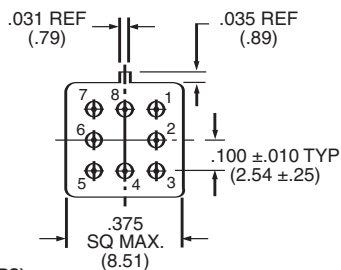

SCHEMATIC DIAGRAM

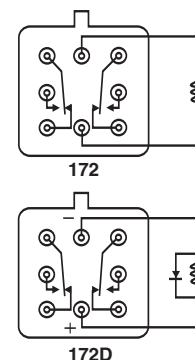

SCHEMATIC IS VIEWED FROM TERMINALS

PERFORMANCE CURVES (Note 2)

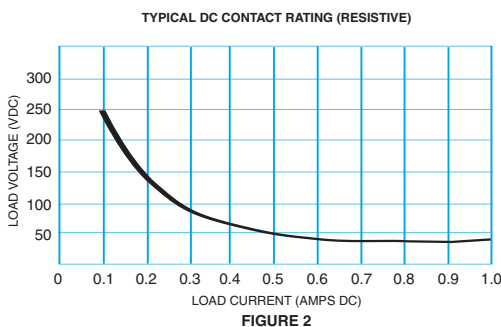
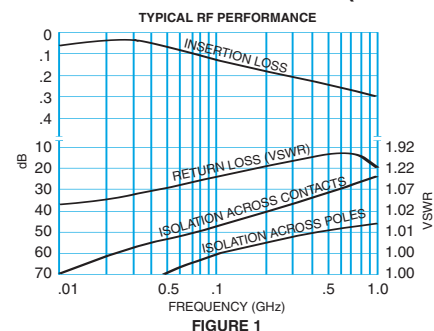

GENERAL NOTES

1. Relay contacts will exhibit no chatter in excess of 10 μsec or transfer in excess of 1 μsec.
2. "Typical" characteristics are based on available data and are best estimates. No on-going verification tests are performed.
3. Unless otherwise specified, parameters are initial values.
4. Relays can be supplied with a spacer pad. See appendix.

Appendix A: Spacer Pads

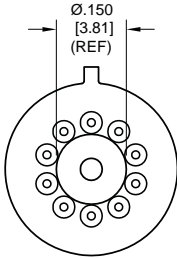
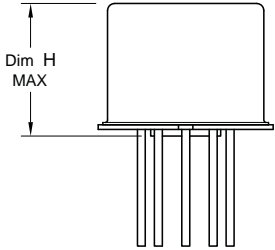
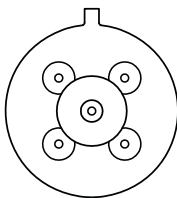
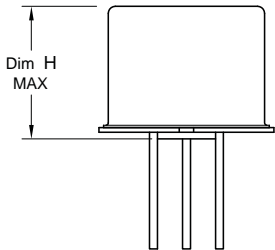
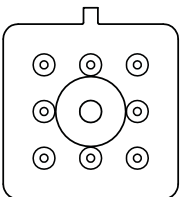
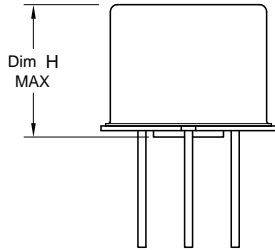
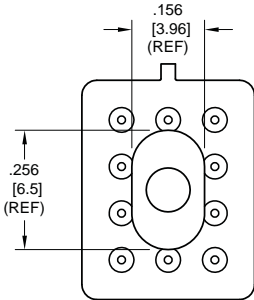
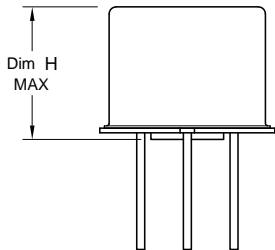
Pad designation and bottom view dimensions	Height	For use with the following:	Dim. H Max.
 <p style="text-align: center;">“M4” Pad for TO-5</p>		ER411T ER412, ER412D, ER412DD	.295 (7.49)
		712, 712D, 712TN, RF300, RF310, RF320	.300 (7.62)
		ER420, ER422D, ER420DD, 421, ER421D, ER421DD, ER422, ER422D, ER422DD, 722, 722D, RF341	.305 (7.75)
		ER431T, ER432T, ER432, ER432D, ER432DD	.400 (10.16)
		732, 732D, 732TN, RF303, RF313, RF323	.410 (10.41)
		RF312	.350 (8.89)
 <p style="text-align: center;">“M4” Pad for TO-5</p>		ER411, ER411D, ER411DD	.295 (7.49)
		ER431, ER431D, ER431DD	.400 (10.16)
		RF311	.300 (7.62)
		RF331	.410 (10.41)
 <p style="text-align: center;">“M4” Pad for Centigrid®</p>		172, 172D	.305 (7.75)
		ER114, ER114D, ER114DD, J114, J114D, J114DD	.300 (7.62)
		ER134, ER134D, ER134DD, J134, J134D, J134DD	.400 (10.16)
		RF100	.315 (8.00)
		RF103	.420 (10.67)
 <p style="text-align: center;">“M9” Pad for Centigrid®</p>		122C, A152	.320 (8.13)
		ER116C, J116C	.300 (7.62)
		ER136C, J136C	.400 (10.16)
		RF180	.325 (8.25)
		A150	.305 (7.75)

Notes:

1. Spacer pad material: Polyester film.
2. To specify an “M4” or “M9” spacer pad, refer to the mounting variants portion of the part numbering example in the applicable datasheet.
3. Dimensions are in inches (mm).
4. Unless otherwise specified, tolerance is $\pm .010$ (.25).
5. Add 10 mΩ to the contact resistance show in the datasheet.
6. Add 0.01 oz. (0.25 g) to the weight of the relay assembly shown in the datasheet.

Appendix A: Spreader Pads

Pad designation and bottom view dimensions	Height	For use with the following:	Dim. H Max.
<p style="text-align: center;">“M” Pad <u>5/ 6/ 9/</u></p>		ER411T, J411T, ER412, ER412D ER412DD, J412, J412D, J412DD ER412T, J412T	.388 (9.86)
		712, 712D, 712TN	.393 (9.99)
		ER431T, J431T, ER432, ER432D ER432DD, J432, J432D, J432DD ER432T, J432T	.493 (12.52)
		732, 732D, 732TN	.503 (12.78)
		ER420, J420, ER420D, J420D ER420DD, J420DD, ER421, J421 ER421D, J421D, ER421DD J422D, ER422DD, J422DD, 722	.398 (10.11)
<p style="text-align: center;">“M4” Pad <u>7/ 8/</u></p>		ER411T ER412, ER412D, ER412DD J412, J412D, J412DD	.441 (11.20)
		712, 712D	.451 (11.46)
		ER421, ER421D, ER421DD 722, 732D	.451 (11.46)
		ER431T ER432, ER432D, ER432DD	.546 (13.87)
		732, 732D	.556 (14.12)
<p style="text-align: center;">“M5” Pad <u>5/ 6/ 9/</u></p>		ER411, ER411D, ER411DD ER411TX ER412X, ER412DX, ER412DDX ER412TX	.388 (9.86)
		712X, 712DX, 712TNX	.393 (9.99)
		ER420X, ER420DX, ER420DDX ER421X, ER421DX, ER421DDX ER422X, ER422DX ER422DDX, 722X, 722DDX	.398 (10.11)
		ER431, ER431D, ER431DD ER431TX ER432X, ER432DX, ER432DDX ER432TX	.493 (12.52)
		732X, 732DX, 732TNX	.503 (12.78)

Notes:

1. Spreader pad material: Diallyl Phthalate.
2. To specify an “M”, “M2” or “M3” spreader pad, refer to the mounting variants portion of the part number example in the applicable datasheet.
3. Dimensions are in inches (mm).
4. Unless otherwise specified, tolerance is $\pm .010$ ” (0.25).
- 5/. Add 25 mΩ to the contact resistance shown in the datasheet.
- 6/. Add .01 oz. (0.25 g) to the weight of the relay assembly shown in the datasheet.
- 7/. Add 50 mΩ to the contact resistance shown in the datasheet.
- 8/. Add 0.025 oz (0.71 g) to the weight of the relay assembly shown in the datasheet.
- 9/. M3 pad to be used only when the relay has a center pin (e.g. ER411M3-12A, 722XM3-26.)

Appendix A: Ground Pin Positions

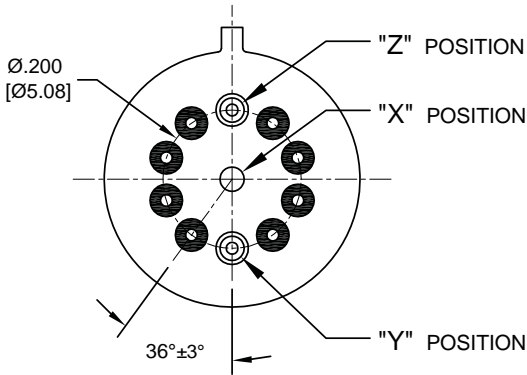

TO-5 Relays:

ER411T, ER412, ER412T, ER420, ER421, ER422,
ER431T, ER432, ER432T, 712, 712TN, 400H, 400K,
400V, RF300, RF303, RF341, RF312, RF310, RF313,
RF320, RF323

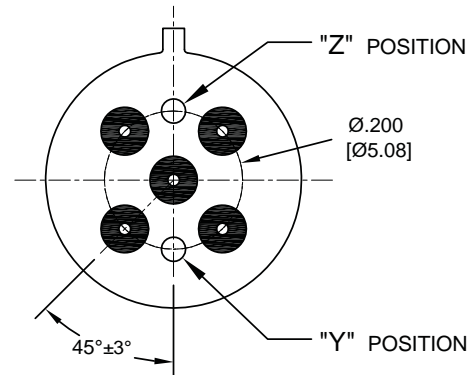

TO-5 Relays:

ER411, ER431, RF311, RF331

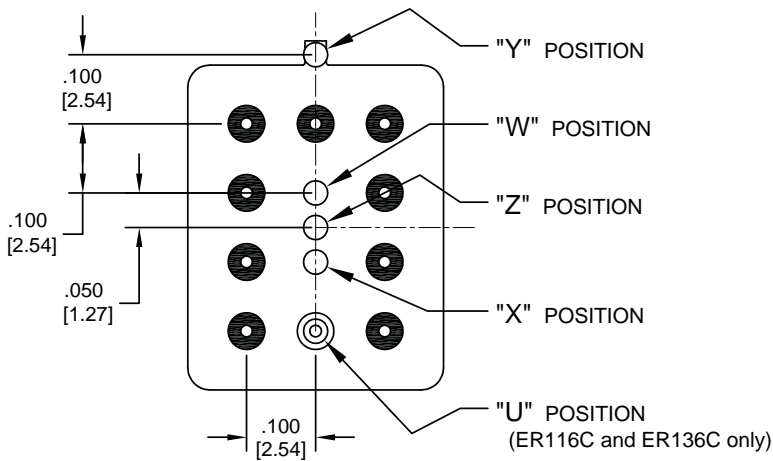

Centigrid® Relays:

RF180, ER116C, 122C, ER136C

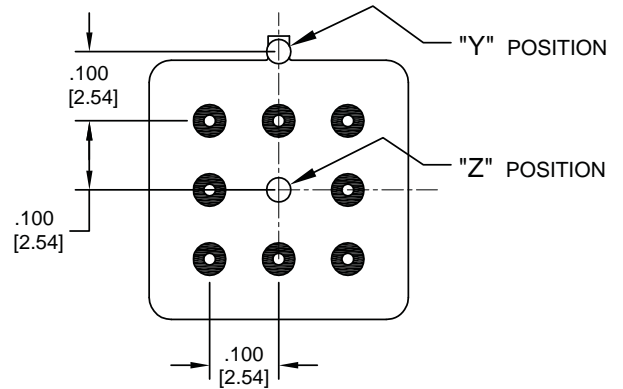

Centigrid® Relays:

RF100, RF103, ER114, ER134, 172

- Indicates ground pin position
- Indicates glass insulated lead position
- ◎ Indicates ground pin or lead position depending on relay type

NOTES

1. Terminal views shown
2. Dimensions are in inches (mm)
3. Tolerances: ± .010 (±.25) unless otherwise specified
4. Ground pin positions are within .015 (0.38) dia. of true position
5. Ground pin head dia., 0.035 (0.89) ref; height 0.010 (0.25) ref.
6. Lead dia. 0.017 (0.43) nom.

Mouser Electronics

Authorized Distributor

Click to View Pricing, Inventory, Delivery & Lifecycle Information:

Teledyne Relays:

[172-12](#) [172-26](#) [172-5](#) [172D-12](#) [172D-26](#) [172D-5](#) [172DM4-12](#) [172DM4-26](#) [172M4-5](#) [400-192-10](#) [400-192-59](#)
[172-12/G](#)