

THIS DRAWING IS UNPUBLISHED. RELEASED FOR PUBLICATION 20
 © COPYRIGHT 20 BY - ALL RIGHTS RESERVED.

REVISIONS					
P	LTR	DESCRIPTION	DATE	DWN	APVD
	G1	REVISED PER ECR-16-011494	22JUN2017	NK	CX

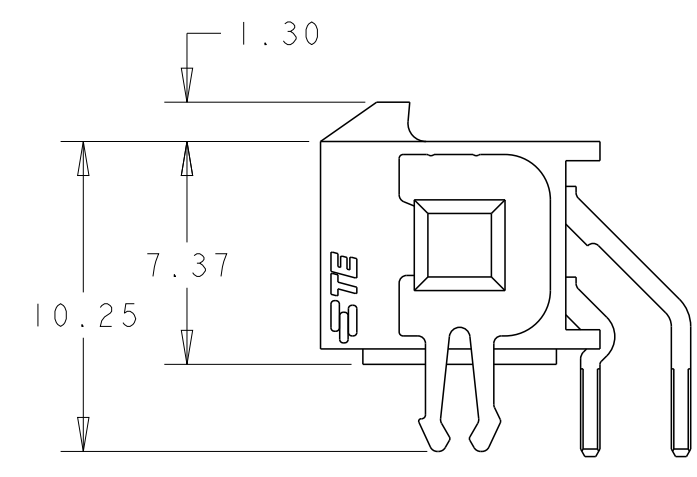

- 1 MATERIAL;
CONTACTS - BRASS.
HOUSING - UL 94V-0 RATED HIGH TEMP NYLON, COLOR; BLACK.
- 2 PLATING;
CONTACTS - 2.54µm MINIMUM TIN-LEAD OVER 1.27µm MINIMUM NICKEL ALL OVER.
- 4 RECOMMENDED PC BOARD THICKNESS OF 1.57.
- 5 PLATING;
CONTACTS - 2.54µm MINIMUM MATTE TIN OVER 1.27µm MINIMUM NICKEL ALL OVER.

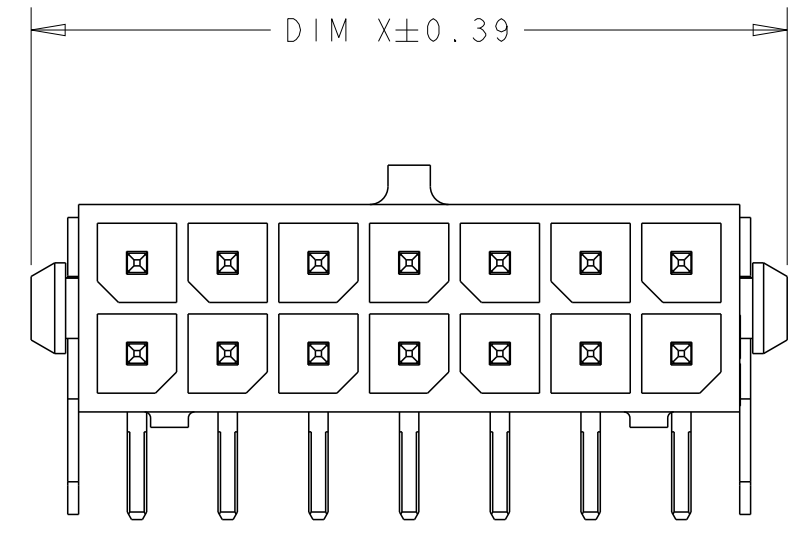
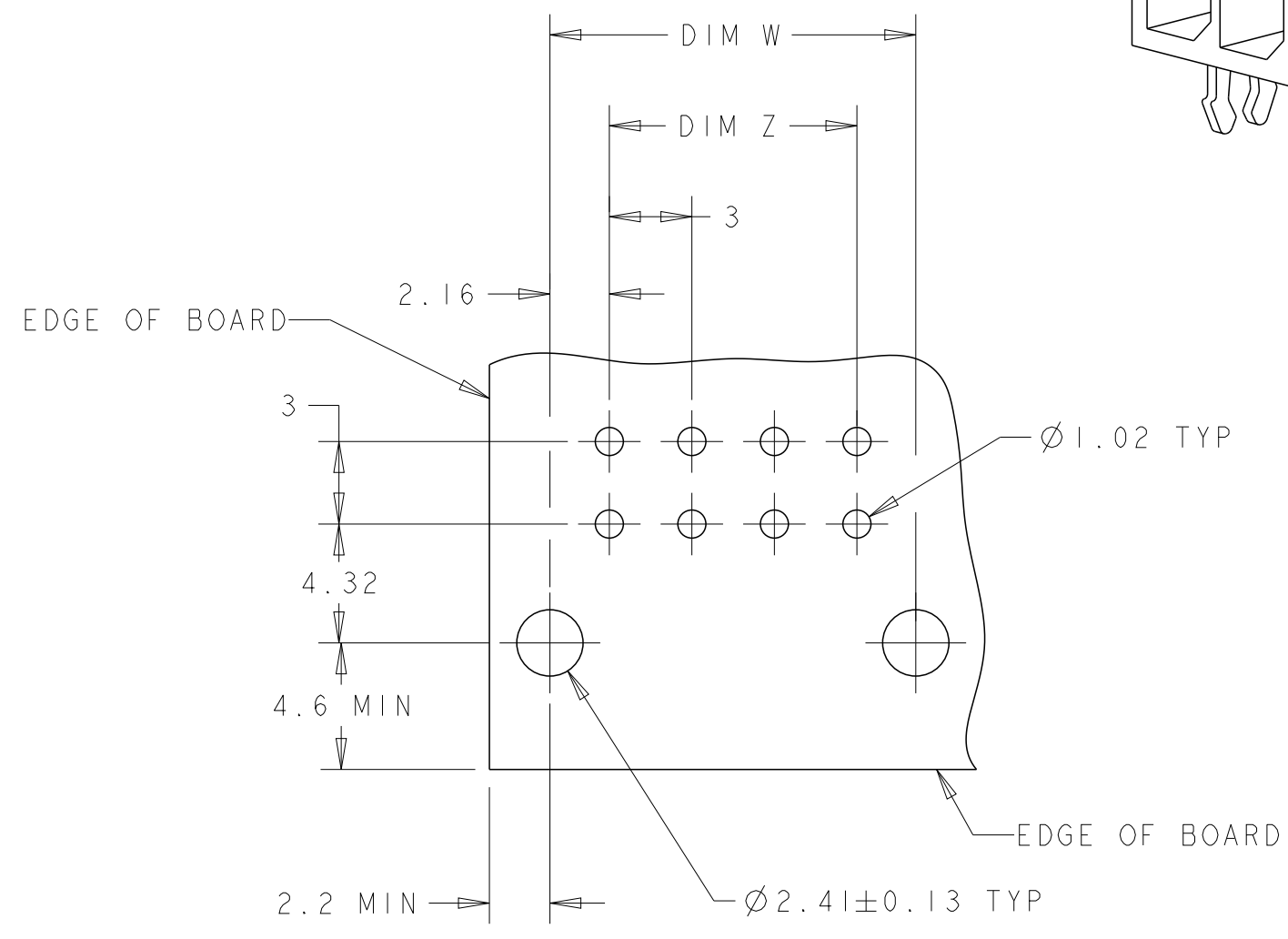
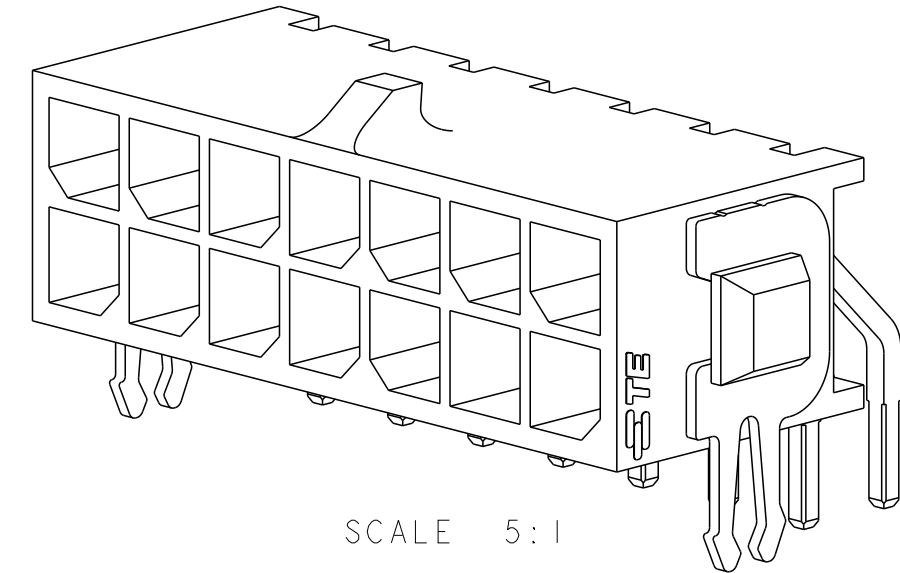
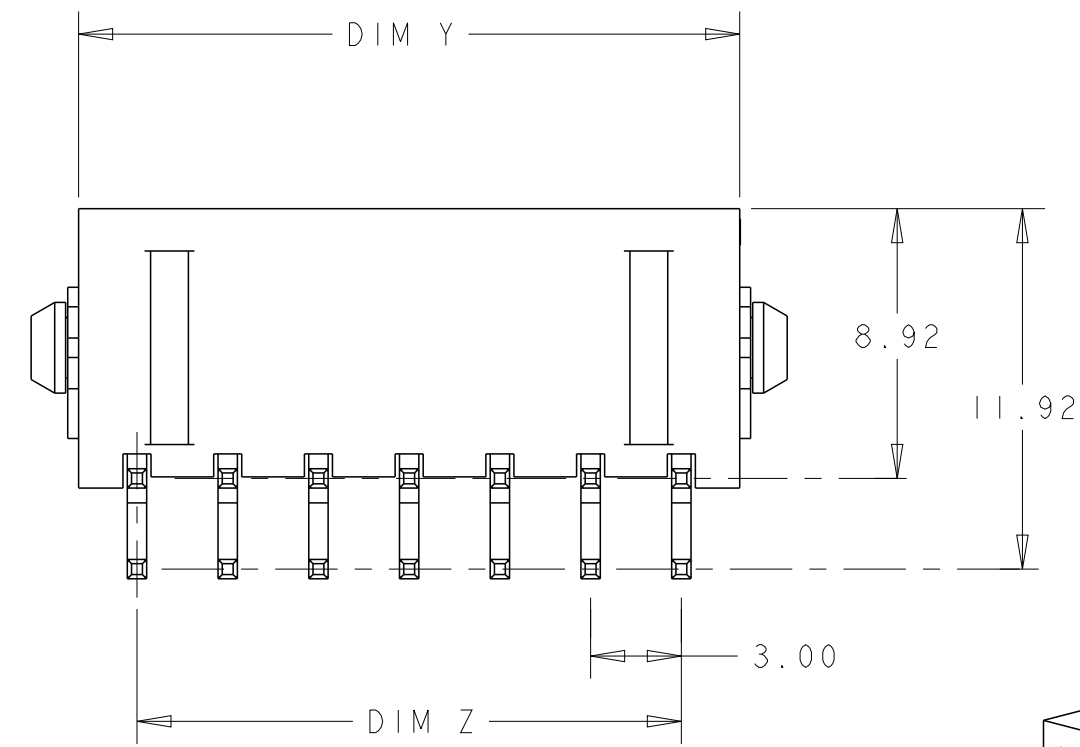

RECOMMENDED PCB LAYOUT (COMPONENT SIDE) 4

FINISH	DIM Y	DIM W	DIM Z	DIM X	NO. OF POSN.	PART NUMBER
5	36.86	37.30	33.00	40.00	24	5-794677-4
5	33.86	34.30	30.00	37.00	22	5-794677-2
5	30.86	31.30	27.00	34.00	20	5-794677-0
5	27.86	28.30	24.00	31.00	18	4-794677-8
5	24.86	25.30	21.00	28.00	16	4-794677-6
5	21.86	22.30	18.00	25.00	14	4-794677-4
5	18.86	19.30	15.00	22.00	12	4-794677-2
5	15.86	16.30	12.00	19.00	10	4-794677-0
5	12.86	13.30	9.00	16.00	8	3-794677-8
5	9.86	10.30	6.00	13.00	6	3-794677-6
5	6.86	7.30	3.00	10.00	4	3-794677-4
5	3.86	4.30	-	7.00	2	3-794677-2
2	36.86	37.30	33.00	40.00	24	2-794677-4
2	33.86	34.30	30.00	37.00	22	2-794677-2
2	30.86	31.30	27.00	34.00	20	2-794677-0
2	27.86	28.30	24.00	31.00	18	1-794677-8
2	24.86	25.30	21.00	28.00	16	1-794677-6
2	21.86	22.30	18.00	25.00	14	1-794677-4
2	18.86	19.30	15.00	22.00	12	1-794677-2
2	15.86	16.30	12.00	19.00	10	1-794677-0
2	12.86	13.30	9.00	16.00	8	794677-8
2	9.86	10.30	6.00	13.00	6	794677-6
2	6.86	7.30	3.00	10.00	4	794677-4
2	3.86	4.30	-	7.00	2	794677-2

THIS DRAWING IS A CONTROLLED DOCUMENT.		DWN B. HAYMAKER 12AUG99	TE Connectivity		
DIMENSIONS: mm		CHK K. COBLE 12AUG99			
TOLERANCES UNLESS OTHERWISE SPECIFIED:		APVD K. COBLE 12AUG99	NAME THRU-HOLE, RIGHT ANGLE, TIN HEADER MECHANICAL BOARDLOCK, DUAL ROW, MICRO MATE-N-LOK™		
0 PLC ± 1 PLC ± 2 PLC ±0.13 3 PLC ± 4 PLC ±		PRODUCT SPEC -	SIZE A2		
MATERIAL SEE TABLE		APPLICATION SPEC -	CAGE CODE 20779	DRAWING NO G-794677	RESTRICTED TO -
ANGLES ±		WEIGHT -	SCALE 4:1 SHEET 1 OF 1 REV G1		
FINISH		CUSTOMER DRAWING			

Mouser Electronics

Authorized Distributor

Click to View Pricing, Inventory, Delivery & Lifecycle Information:

[TE Connectivity:](#)

[4-794677-4](#)