

## Features

- Usable bandwidth 35 MHz
- High attenuation
- No impedance matching required for operation at 50 Ω
- Single-ended operation
- Ceramic Surface Mount Package (SMP)
- Hermetic
- RoHS compliant (2002/95/EC), Pb-free 

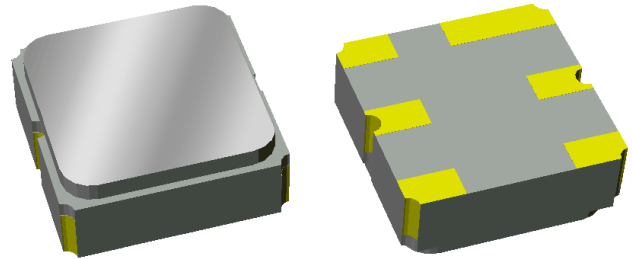

## Package

Surface Mount 3.00 x 3.00 x 1.22 mm

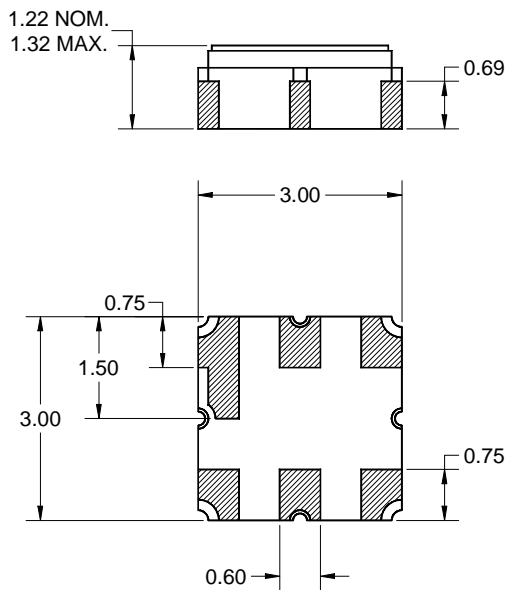

## Pin Configuration

Bottom View

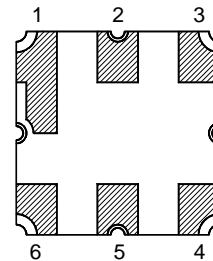

Pin No.	Description
2	Input
5	Output
1,3,4,6	Case ground

Dimensions shown are nominal in millimeters  
 All tolerances are  $\pm 0.15$ mm except overall  
 length and width  $\pm 0.10$ mm

Body:  $Al_2O_3$  ceramic  
 Lid: Kovar, Ni plated  
 Terminations: Au plating 0.5 - 1.0 $\mu$ m,  
 over a 2 - 6 $\mu$ m Ni plating

**Electrical Specifications <sup>(1)</sup>**

Operating Temperature Range: <sup>(2)</sup> -10 to +80 °C

Parameter <sup>(3)</sup>	Minimum	Typical	Maximum	Unit
<b>Center Frequency</b>	-	897.5	-	MHz
<b>Maximum Insertion Loss</b> 880 - 915 MHz	-	1.8	2.5	dB
<b>Amplitude Ripple</b> 880 - 915 MHz	-	1.0	1.6	dB p-p
<b>Absolute Attenuation</b>				
10 - 860 MHz	19	22	-	dB
860 - 865 MHz	20	26	-	dB
930 - 935 MHz	14	55	-	dB
935 - 960 MHz	25	28	-	dB
960 - 1780 MHz	21	24	-	dB
1780 - 1850 MHz	21	30	-	dB
1850 - 2250 MHz	15	20	-	dB
2250 - 3000 MHz	6	13	-	dB
<b>Input/Output VSWR</b> 880 - 915 MHz	-	1.8	2.2	-
<b>Source Impedance <sup>(4)</sup></b>	-	50	-	Ω
<b>Load Impedance <sup>(4)</sup></b>	-	50	-	Ω

**Notes:**

1. All specifications are based on the test circuit shown below
2. In production, devices will be tested at room temperature to a guardbanded specification to ensure electrical compliance over temperature
3. Electrical margin has been built into the design to account for the variations due to temperature drift and manufacturing tolerances
4. This is the optimum impedance in order to achieve the performance shown

**Test Circuit:**

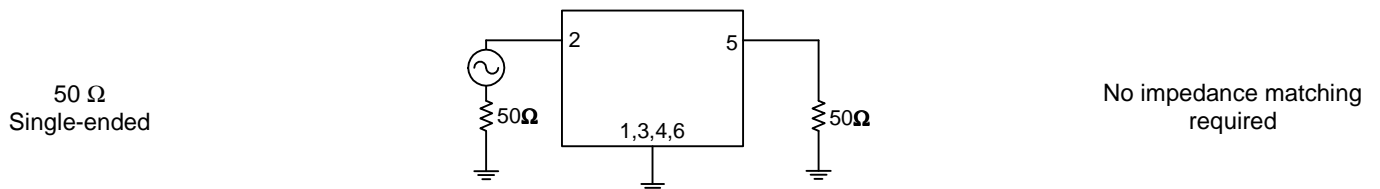

**Electrical Specifications <sup>(1)</sup>**

Operating Temperature Range: <sup>(2)</sup> -30 to +85 °C

Parameter <sup>(3)</sup>	Minimum	Typical	Maximum	Unit
<b>Center Frequency</b>	-	897.5	-	MHz
<b>Maximum Insertion Loss</b> 880 - 915 MHz	-	1.8	2.8	dB
<b>Amplitude Ripple</b> 880 - 915 MHz	-	1.0	1.8	dB p-p
<b>Absolute Attenuation</b>				
10 - 860 MHz	19	22	-	dB
860 - 865 MHz	20	26	-	dB
930 - 935 MHz	14	55	-	dB
935 - 960 MHz	25	28	-	dB
960 - 1780 MHz	21	24	-	dB
1780 - 1850 MHz	21	30	-	dB
1850 - 2250 MHz	15	20	-	dB
2250 - 3000 MHz	6	13	-	dB
<b>Input/Output VSWR</b> 880 - 915 MHz	-	1.8	2.2	-
<b>Source Impedance <sup>(4)</sup></b>	-	50	-	$\Omega$
<b>Load Impedance <sup>(4)</sup></b>	-	50	-	$\Omega$

**Notes:**

1. All specifications are based on the test circuit shown below
2. In production, devices will be tested at room temperature to a guardbanded specification to ensure electrical compliance over temperature
3. Electrical margin has been built into the design to account for the variations due to temperature drift and manufacturing tolerances
4. This is the optimum impedance in order to achieve the performance shown

**Test Circuit:**

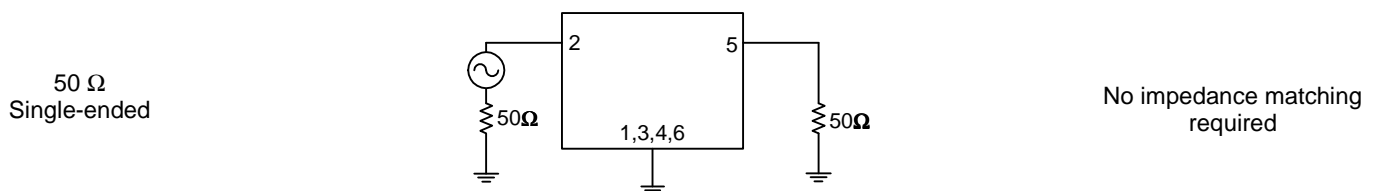

**Typical Performance (at +25°C)**

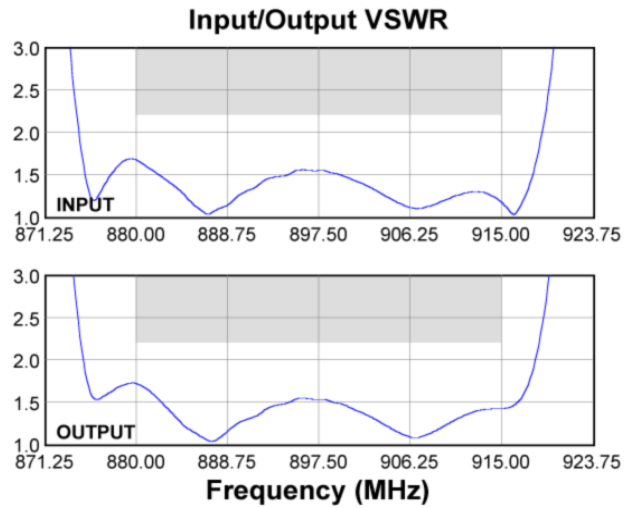
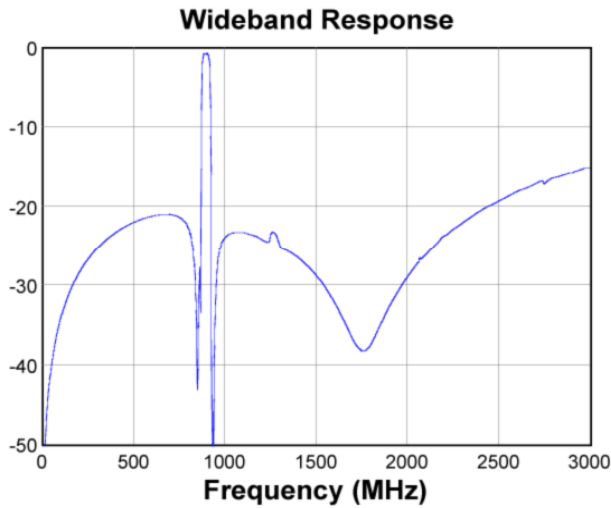
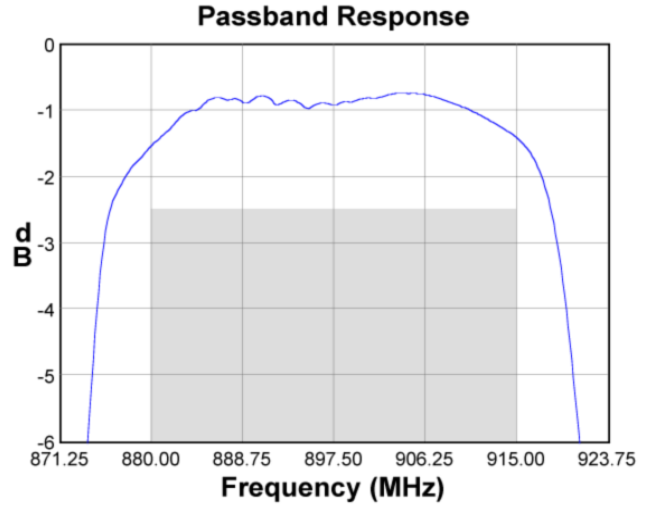
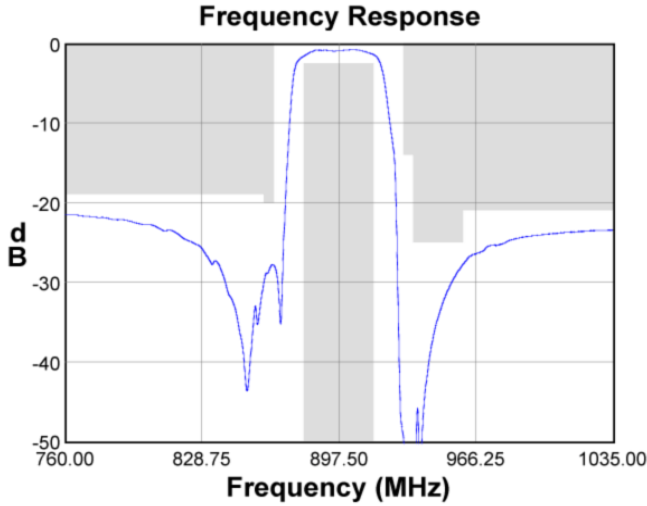

**Input Smith Chart**

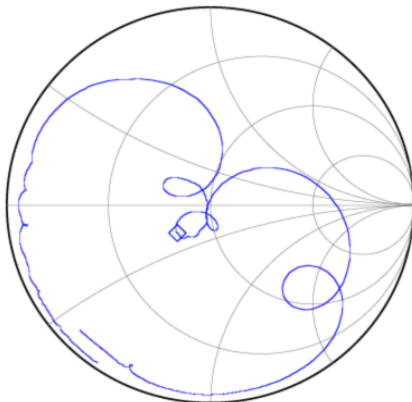

**Output Smith Chart**

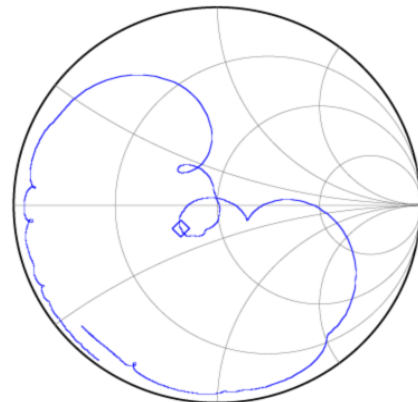

**Matching Schematics**

50  $\Omega$   
Single-ended

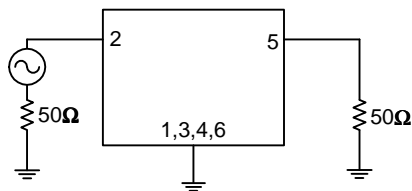

No impedance matching required

**Marking**

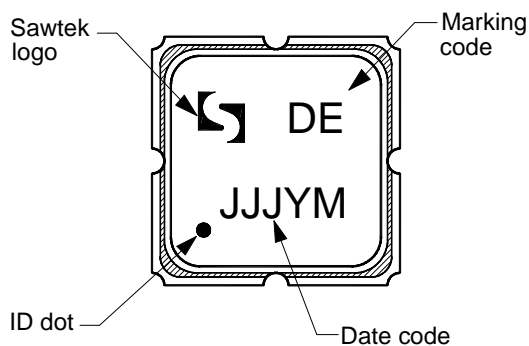

The date code consists of: JJJ = Julian day,  
Y = last digit of year, M = manufacturing site code

**PCB Footprint**

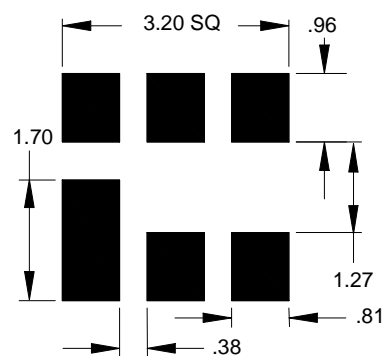

This footprint represents a recommendation only  
Dimensions shown are nominal in millimeters

**Tape and Reel**

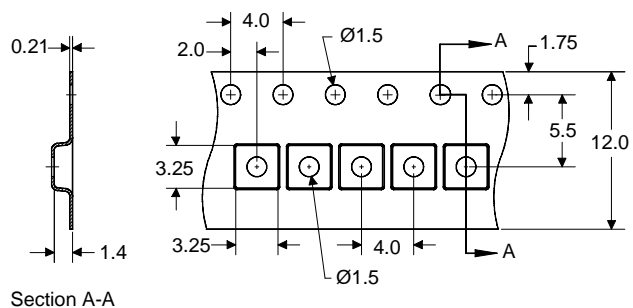
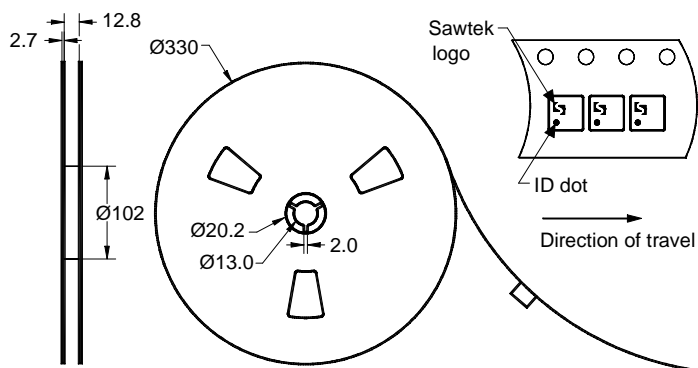

Dimensions shown are nominal in millimeters  
Packaging quantity: 5000 units/reel

### Maximum Ratings

Parameter	Symbol	Minimum	Maximum	Unit
Operating Temperature Range	T	-30	+85	°C
Storage Temperature Range	T <sub>stg</sub>	-40	+85	°C
Input Power <sup>(1)</sup>	P <sub>in</sub>	-	+19	dBm

**Note:**

1. Input Power is targeted for an applied RF signal at 55 °C for 10,000 hours

### Important Notes

**Warnings**

- Electrostatic Sensitive Device (ESD) 
- Avoid ultrasonic exposure

**RoHS Compliance**

- This product complies with EU directive 2002/95/EC (RoHS) 

**Solderability**

- Compatible with JEDEC J-STD-020C **Pb-free** process, **260°C** peak reflow temperature ([see soldering profile](#))

### Links to Additional Technical Information

[PCB Layout Tips](#)

[Qualification Flowchart](#)

[Soldering Profile](#)

[S-Parameters](#)

[RoHS Information](#)

[Other Technical Information](#)

TriQuint's liability is limited only to the Surface Acoustic Wave (SAW) component(s) described in this data sheet. TriQuint does not accept any liability for applications, processes, circuits or assemblies, which are implemented using any TriQuint component described in this data sheet.

### Contact Information

**TriQuint**   
SEMICONDUCTOR

PO Box 609501  
Orlando, FL 32860-9501  
USA

Phone: +1 (407) 886-8860  
Fax: +1 (407) 886-7061  
Email: [info-product@tqs.com](mailto:info-product@tqs.com)  
Web: [www.triquint.com](http://www.triquint.com)

Or contact one of our worldwide  
Network of [sales offices](#),  
[Representatives or distributors](#)

# Mouser Electronics

Authorized Distributor

Click to View Pricing, Inventory, Delivery & Lifecycle Information:

[Qorvo:](#)

[856671](#) [856671-EVB](#)