

Hybrid Energy Storage Capacitors



Image is not to scale

FEATURES

- Polarized energy storage capacitor with high capacity and energy density
- Voltage flexibility: 1.4 V (single cell) to 2.8 V / 4.2 V / 5.6 V / 7.0 V / 8.4 V (multiple cells)
- Available in stacked through-hole (STH, radial), surface-mount flat (SMF) and lay flat configurations (LFC) with wire and connectors
- Useful life: up to 2000 h at 85 °C
- No cell balancing necessary
- Soft and low transient-voltage-controlled charging characteristic
- Non-hazardous electrolyte
- Maintenance-free, no service necessary
- Evaluation kits for engineering are available under ordering code: MAL219699001E3
- Material categorization: for definitions of compliance please see www.vishay.com/doc?99912



RoHS
COMPLIANT

APPLICATIONS

- Power backup for memory controller, flash backup, RAID systems, SRAM, DRAM
- Power failure and write cache protection for enterprise SSD and HDD
- Real time clock power source
- Burst power support for flash lights, wireless transmitters
- Backup power for industrial PC's and industrial controls
- Storage device for energy harvesting
- Emergency light and micro UPS power source

MARKING

The capacitors are marked with the following information:

- Rated capacitance (in F)
- Rated voltage (in V)
- Date code
- Negative / positive terminal identification

PACKAGING

Supplied in ESD trays only



QUICK REFERENCE DATA						
DESCRIPTION	VALUE					
	SINGLE CELL	2 CELLS	3 CELLS	4 CELLS	5 CELLS	6 CELLS
Nominal case size (Ø D x L in mm) Stacked Through-Hole (STH)	7 x 2.5 12 x 2.5 25 x 15 x 2.5 35 x 25 x 5	7 x 5 12 x 5 25 x 15 x 5 35 x 25 x 7.5	7 x 7.5 12 x 7.5 25 x 15 x 7.5 35 x 25 x 10	7 x 10 12 x 10 25 x 15 x 10 35 x 25 x 15	7 x 12.5 12 x 12.5 - 35 x 25 x 17.5	7 x 15 12 x 15 - 35 x 25 x 20
Nominal case size (Ø W x L x H in mm) Surface-Mount Flat (SMF)	7 x 7 x 2.5 12 x 12 x 2.5 -	7 x 14 x 2.5 12 x 24 x 2.5 -	13 x 14 x 2.5 22 x 24 x 2.5 -	14 x 14 x 2.5 24 x 24 x 2.5 -	-	-
Nominal case size (W x L x H in mm) Lay Flat (LFC)	14.5 x 12 x 2.5	14.5 x 24 x 2.5	14.5 x 36 x 2.5	14.5 x 48 x 2.5	14.5 x 60 x 2.5	14.5 x 72 x 2.5
Rated capacitance range, C _R	4.0 F 15.0 F 45.0 F 90.0 F	4.0 F 15.0 F 45.0 F 90.0 F	4.0 F 15.0 F 45.0 F 90.0 F	4.0 F 15.0 F 45.0 F 90.0 F	4.0 F 15.0 F - 90.0 F	4.0 F 15.0 F - 90.0 F
Tolerance on C _R at 20 °C	-20 % to +80 %					
Rated voltage, U _R	1.4 V	2.8 V	4.2 V	5.6 V	7.0 V	8.4 V
Maximum surge voltage, U _S (max. 30 s)	1.6 V	3.2 V	4.8 V	6.4 V	8.0 V	9.6 V
Minimum stored energy	4 Ws 17 Ws 50 Ws 115 Ws	9 Ws 35 Ws 100 Ws 230 Ws	13 Ws 52 Ws 150 Ws 345 Ws	18 Ws 70 Ws 200 Ws 460 Ws	22 Ws 87 Ws - 575 Ws	27 Ws 105 Ws - 690 Ws
Energy density	9 Ws/g to 13 Ws/g					
Category temperature range	4.0 F: -20 °C to +70 °C 15.0 F / 45.0 F / 90.0 F: -20 °C to +85 °C					
Storage temperature range	-40 °C to +85 °C					
Useful life at U _R	4.0 F: at 70 °C: 1000 h at 55 °C: 2800 h at 45 °C: 5600 h		15.0 F: at 85 °C: 1000 h at 70 °C: 2800 h at 60 °C: 5600 h		45.0 F, 90.0 F: at 85 °C: 2000 h at 70 °C: 5600 h at 60 °C: 11 200 h	
Shelf life	1000 h at upper category temperature					
Climatic category IEC 60068	25 / 085 / 21					

SELECTION CHART FOR C _R , U _R , AND FORM AT UPPER CATEGORY TEMPERATURE (UCT)							
C _R (F)	FORM	U _R (V)					
		1.4	2.8	4.2	5.6	7.0	8.4
4	A2	7.0 x 2.5	7.0 x 5.0	7.0 x 7.5	7.0 x 10.0	7.0 x 12.5	7.0 x 15.0
	B2	7.0 x 2.5	7.0 x 5.0	7.0 x 7.5	7.0 x 10.0	7.0 x 12.5	7.0 x 15.0
	B3						
	C	7.0 x 7.0 x 2.5	-	-	-	-	-
	D	7.0 x 7.0 x 2.5	-	-	-	-	-
	E	-	7.0 x 14.0 x 2.5	13.0 x 14.0 x 2.5	14.0 x 14.0 x 2.5	-	-
15	A2	12.0 x 2.5	12.0 x 5.0	12.0 x 7.5	12.0 x 10.0	12.0 x 12.5	12.0 x 15.0
	B2	12.0 x 2.5	12.0 x 5.0	12.0 x 7.5	12.0 x 10.0	12.0 x 12.5	12.0 x 15.0
	B3						
	C	12.0 x 12.0 x 2.5	-	-	-	-	-
	D	12.0 x 12.0 x 2.5	-	-	-	-	-
	E	-	12.0 x 24.0 x 2.5	22.0 x 24.0 x 2.5	24.0 x 24.0 x 2.5	-	-
	F	14.5 x 12.0 x 2.5	14.5 x 24.0 x 2.5	14.5 x 36.0 x 2.5	14.5 x 48.0 x 2.5	14.5 x 60.0 x 2.5	14.5 x 72.0 x 2.5
45	I	25 x 15 x 2.5	25 x 15 x 5	25 x 15 x 7.5	25 x 15 x 10	-	-
	K						
90	G	35 x 25 x 5	35 x 25 x 7.5	35 x 25 x 10	35 x 25 x 15	35 x 25 x 17.5	35 x 25 x 20
	H						

DIMENSIONS in millimeters **AND AVAILABLE FORMS**

STACKED THROUGH HOLE CONFIGURATION (STH): Examples VERTICAL MOUNT

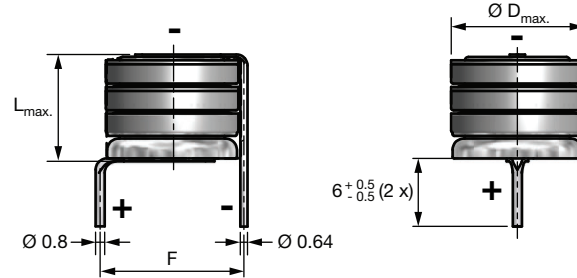

Fig. 1 - Form A2: Stacked Through Hole (example 4 cells, 2 pins) ⁽¹⁾

STACKED THROUGH HOLE CONFIGURATION (STH): Examples HORIZONTAL MOUNT

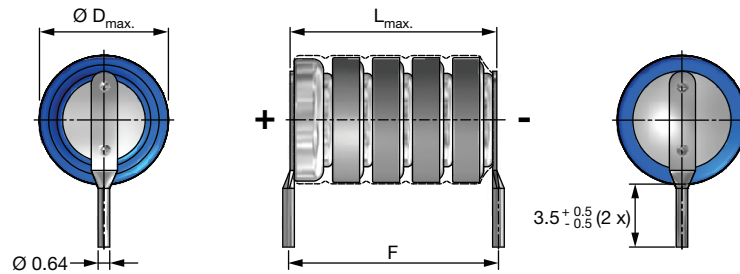

Fig. 2 - Form B2: Stacked Through Hole (example 5 cells, 2 pins) ⁽¹⁾

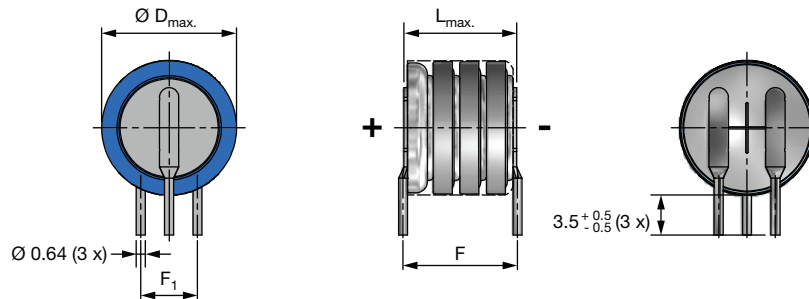

Fig. 3 - Form B3: Stacked Through Hole (example 4 cells, keyed polarity - 3 pins) ⁽¹⁾

Note

⁽¹⁾ Bottom and top are not isolated

SURFACE MOUNT FLAT CONFIGURATION (SMF): Examples

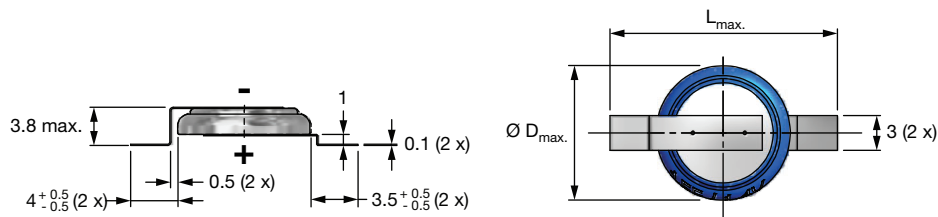

Fig. 4 - Form C: Surface Mount Flat (single cell, keyed polarity)

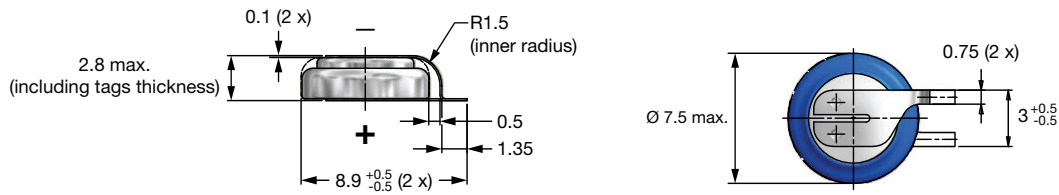

Fig. 5 - Form D1: Surface Mount Flat (single cell, keyed polarity)



Fig. 6 - Form D2: Surface Mount Flat (single cell, keyed polarity)

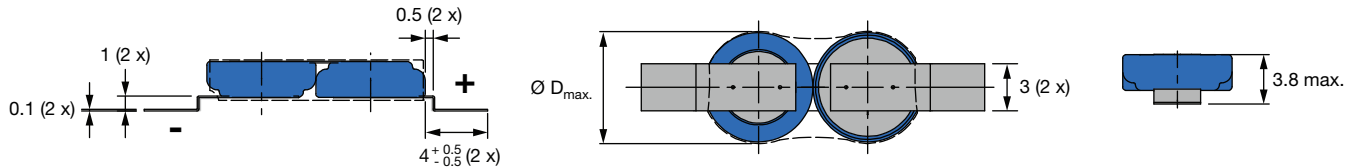

Fig. 7 - Form E2: Surface Mount Flat

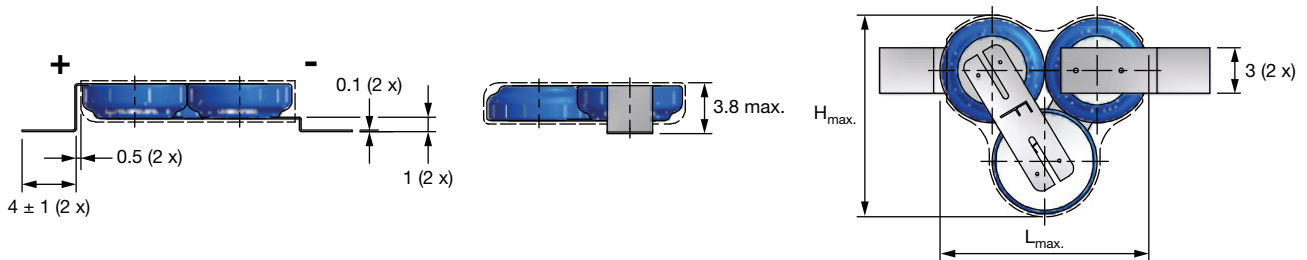

Fig. 8 - Form E3: Surface Mount Flat

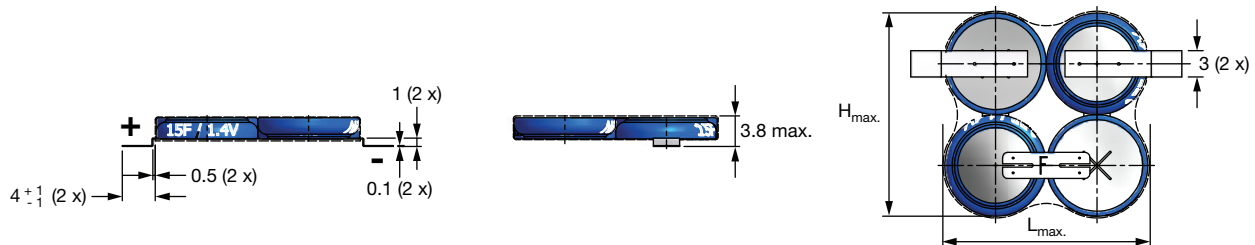

Fig. 9 - Form E4: Surface Mount Flat

LAY FLAT CONFIGURATION (LFC) WITH CONNECTOR: Example 5 cells in series

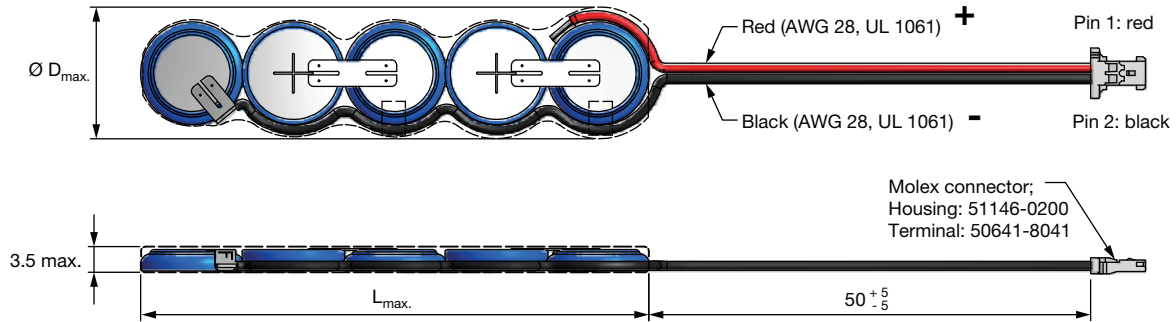

Fig. 10 - Form F: Lay Flat (example for 5 cells)

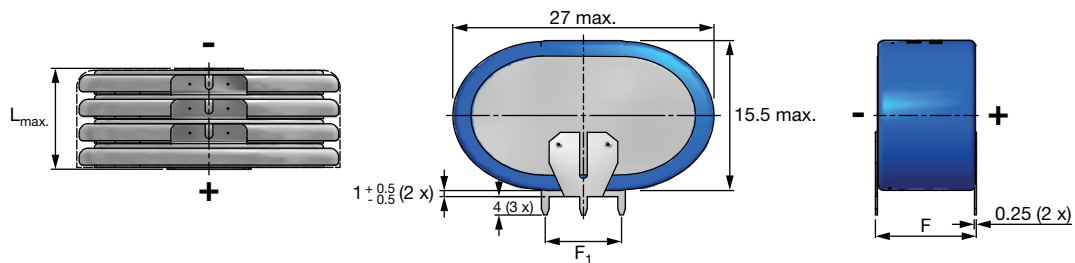

Fig. 11 - Form I: Stacked Through Hole Oval (PCBD)

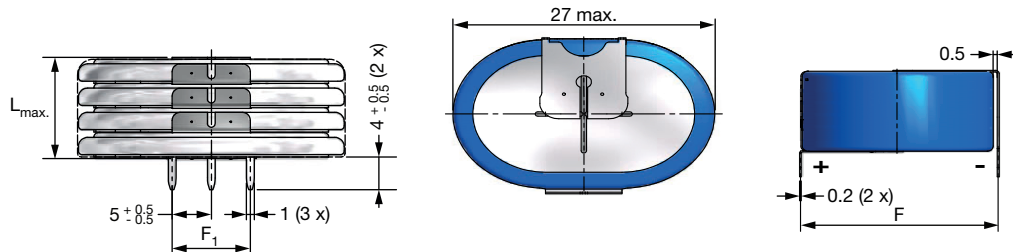

Fig. 12 - Form K: Stacked Through Hole Oval Horizontal

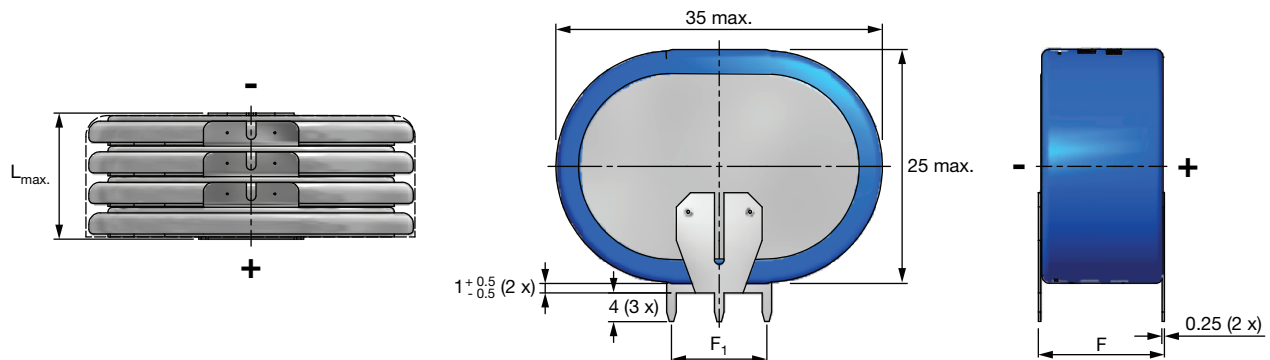

Fig. 13 - Form G: Stacked Through Hole Oval (PCBD)

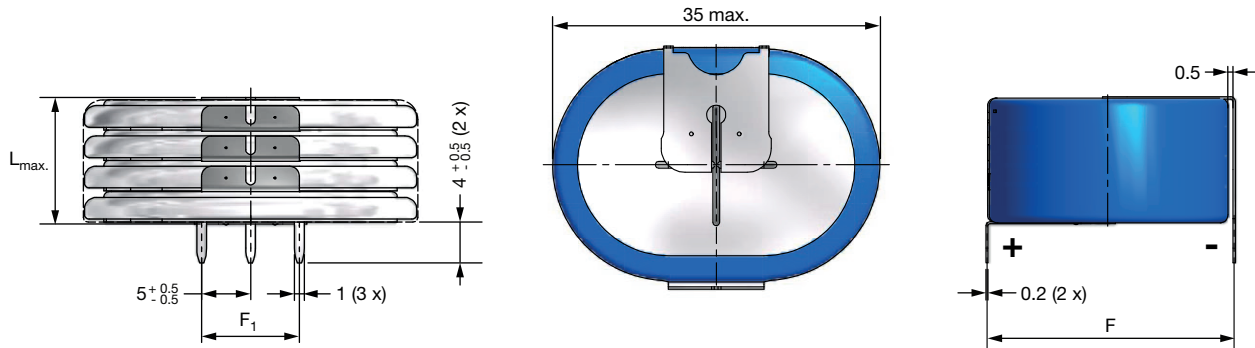

Fig. 14 - Form H: Stacked Through Hole Oval Horizontal

Table 1

DIMENSIONS in millimeters, MASS AND PACKAGING QUANTITIES						
NOMINAL CASE SIZE D x L x H (mm)	FORM	Ø D _{max.}	L _{max.}	L1 _{max.}	H _{max.}	MASS (g)
7.0 x 7.0 x 2.5	A2, B2, B3	7.5	2.3 + 0.3	7.0 + 0.5	-	0.5
7.0 x 7.0 x 2.5	C	7.5	7.0	7.0 + 8.0	-	0.5
7.0 x 7.0 x 2.5	D1	7.5	7.0	7.0 + 4.0	-	0.5
7.0 x 7.0 x 5.0	A2, B2, B3	7.5	4.2	4.2 + 0.5	-	0.8
7.0 x 7.0 x 7.5	A2, B2, B3	7.5	7.5	7.8 + 0.5	-	1.5
7.0 x 7.0 x 10.0	A2, B2, B3	7.5	10.5	10.2 + 0.5	-	1.8
7.0 x 7.0 x 12.5	A2, B2, B3	7.5	12.5	12.4 + 0.5	-	2.5
7.0 x 7.0 x 15.0	A2, B2, B3	7.5	14.8	14.8 + 0.5	-	3.0
12.0 x 12.0 x 2.5	A2, B2, B3	12.5	2.3	2.3 + 0.5	-	1.2
12.0 x 12.0 x 2.5	C	12.5	12.5	12.5 + 8.0	-	1.0
12.0 x 12.0 x 2.5	D2	12.5	12.5	12.5 + 4.0	-	1.0
12.0 x 12.0 x 5.0	A2, B2, B3	12.5	4.2	4.2 + 0.5	-	2.2
12.0 x 12.0 x 7.5	A2, B2, B3	12.5	8.0	7.8 + 0.5	-	3.3
12.0 x 12.0 x 10.0	A2, B2, B3	12.5	10.5	10.5 + 0.5	-	4.0
12.0 x 12.0 x 12.5	A2, B2, B3	12.5	12.5	12.5 + 0.5	-	5.4
12.0 x 12.0 x 15.0	A2, B2, B3	12.5	14.8	14.8 + 0.5	-	6.5
7.0 x 14.0 x 2.5	E2	7.5	14.8	14.8 + 8.0	-	1.0
12.0 x 24.0 x 2.5	E2	12.5	24.0	24.0 + 8.0	-	2.0
13.0 x 14.0 x 2.5	E3	14.0	15.0	14.8 + 8.0	14.0	1.2
22.0 x 24.0 x 2.5	E3	24.0	24.0	24.8 + 8.0	15.0	3.3
14.0 x 14.0 x 2.5	E4	15.0	15.0	14.8 + 8.0	22.5	1.5
24.0 x 24.0 x 2.5	E4	24.0	24.0	24.8 + 8.0	24.0	4.4
14.5 x 12.0 x 2.5	F	14.5	12.0	12.0 + 50.0	-	1.0
14.5 x 24.0 x 2.5	F	14.5	24.0	24.0 + 50.0	-	3.0
14.5 x 36.0 x 2.5	F	14.5	36.0	36.0 + 50.0	-	4.0
14.5 x 48.0 x 2.5	F	14.5	48.0	48.0 + 50.0	-	6.0
14.5 x 60.0 x 2.5	F	14.5	60.0	60.0 + 50.0	-	7.5
14.5 x 72.0 x 2.5	F	14.5	72.0	72.0 + 50.0	-	9.0
25 x 15 x 2.5	I, K	27 x 15.5	3.0	2.5 ± 0.5	-	1.5
25 x 15 x 5.0	I, K	27 x 15.5	5.0	5.0 ± 0.5	-	3.0
25 x 15 x 7.5	I, K	27 x 15.5	7.0	7.0 ± 0.5	-	4.5
25 x 15 x 10.0	I, K	27 x 15.5	9.0	9.0 ± 0.5	-	6.0
35 x 25 x 5.0	G, H	35 x 25	3.7	3.6 ± 0.1	-	7.5
35 x 25 x 7.5	G, H	35 x 25	7.5	7.5 + 0.5	-	15.0
35 x 25 x 10.0	G, H	35 x 25	10.5	10.5 + 0.5	-	22.5
35 x 25 x 15.0	G, H	35 x 25	15.0	14.5 + 0.5	-	30.0
35 x 25 x 17.5	G, H	35 x 25	17.8	16.8 ± 1.0	-	45.0
35 x 25 x 20.0	G, H	35 x 25	21.1	20.1 ± 1.0	-	50.0



ELECTRICAL DATA	
SYMBOL	DESCRIPTION
C _R	Rated capacitance, tolerance -20 % / +80 %, measured by constant current discharge method
UCT	Upper category temperature
I _L	Max. leakage current after 24 h at U _R
R _I	Max. internal resistance at 1 kHz

Note

- Unless otherwise specified, all electrical values in Table 2 apply at T_{amb} = 20 °C, P = 86 kPa to 106 kPa and RH = 45 % to 75 %

ORDERING EXAMPLE

Hybrid Storage Capacitor

15 F / 1.4 V

Nominal case size: Ø 12.0 mm x 2.5 mm; Form B3

Ordering code: MAL219691211E3

Table 2

ELECTRICAL DATA AND ORDERING INFORMATION													
U _R (V)	C _R (F)	NOMINAL CASE SIZE Ø D x L D x L x H (mm)	CASE CODE	FOR M	F (mm)	F1 (mm)	UCT (°C)	I _L 24 h (mA)	ESR AC ⁽¹⁾ 1 kHz (Ω)	ESR DC ⁽²⁾ (Ω)	MIN. STORAGE ENERGY (Ws)	PACKAGING QUANTITIES	ORDERING CODE
STACKED THROUGH HOLE CONFIGURATION (STH) - VERTICAL MOUNT													
1.4	4	7.0 x 2.5	2 pin	A2	7.5	-	70	0.03	2.5	7.5	4.6	80	MAL219691101E3
2.8	4	7.0 x 5.0	2 pin	A2	7.5	-	70	0.03	5.0	15.0	9.2	80	MAL219691102E3
4.2	4	7.0 x 7.5	2 pin	A2	7.5	-	70	0.03	7.5	22.5	13.8	80	MAL219691103E3
5.6	4	7.0 x 10.0	2 pin	A2	7.5	-	70	0.03	10.0	30.0	18.4	80	MAL219691104E3
7.0	4	7.0 x 12.5	2 pin	A2	7.5	-	70	0.03	12.5	37.5	23.0	84	MAL219691105E3
8.4	4	7.0 x 15.0	2 pin	A2	7.5	-	70	0.03	15.0	45.0	27.6	84	MAL219691106E3
1.4	15	12.0 x 2.5	2 pin	A2	12.5	-	85	0.12	0.6	2.5	17.5	80	MAL219691201E3
2.8	15	12.0 x 5.0	2 pin	A2	12.5	-	85	0.12	1.2	5.0	35.0	80	MAL219691202E3
4.2	15	12.0 x 7.5	2 pin	A2	12.5	-	85	0.12	1.8	7.5	52.5	80	MAL219691203E3
5.6	15	12.0 x 10.0	2 pin	A2	12.5	-	85	0.12	2.4	10.0	70.0	80	MAL219691204E3
7.0	15	12.0 x 12.5	2 pin	A2	12.5	-	85	0.12	3.0	12.5	87.5	90	MAL219691205E3
8.4	15	12.0 x 15.0	2 pin	A2	12.5	-	85	0.12	3.6	15.0	105.0	90	MAL219691206E3
STACKED THROUGH HOLE CONFIGURATION (STH) - HORIZONTAL MOUNT													
1.4	4	7.0 x 2.5	2 pin	B2	3.2	-	70	0.03	2.5	7.5	4.6	100	MAL219691121E3
2.8	4	7.0 x 5.0	2 pin	B2	5.4	-	70	0.03	5.0	15.0	9.2	100	MAL219691122E3
4.2	4	7.0 x 7.5	2 pin	B2	7.5	-	70	0.03	7.5	22.5	13.8	96	MAL219691123E3
5.6	4	7.0 x 10.0	2 pin	B2	8.8	-	70	0.03	10.0	30.0	18.4	96	MAL219691124E3
7.0	4	7.0 x 12.5	2 pin	B2	12	-	70	0.03	12.5	37.5	23.0	60	MAL219691125E3
8.4	4	7.0 x 15.0	2 pin	B2	14.5	-	70	0.03	15.0	45.0	27.6	60	MAL219691126E3
1.4	15	12.0 x 2.5	2 pin	B2	3.2	-	85	0.12	0.6	2.5	17.5	100	MAL219691221E3
2.8	15	12.0 x 5.0	2 pin	B2	5.8	-	85	0.12	1.2	5.0	35.0	100	MAL219691222E3
4.2	15	12.0 x 7.5	2 pin	B2	8.3	-	85	0.12	1.8	7.5	52.5	80	MAL219691223E3
5.6	15	12.0 x 10.0	2 pin	B2	11.0	-	85	0.12	2.4	10.0	70.0	90	MAL219691224E3
7.0	15	12.0 x 12.5	2 pin	B2	13.4	-	85	0.12	3.0	12.5	87.5	40	MAL219691225E3
8.4	15	12.0 x 15.0	2 pin	B2	15.7	-	85	0.12	3.6	15.0	105.0	40	MAL219691226E3
1.4	4	7.0 x 2.5	3 pin	B3	2.8	2.5	70	0.03	2.5	7.5	4.6	100	MAL219691111E3
2.8	4	7.0 x 5.0	3 pin	B3	5.1	2.5	70	0.03	5.0	15.0	9.2	100	MAL219691112E3
4.2	4	7.0 x 7.5	3 pin	B3	7.5	2.5	70	0.03	7.5	22.5	13.8	96	MAL219691113E3
5.6	4	7.0 x 10.0	3 pin	B3	10.0	2.5	70	0.03	10.0	30.0	18.4	96	MAL219691114E3
7.0	4	7.0 x 12.5	3 pin	B3	12.0	2.5	70	0.03	12.5	37.5	23.0	60	MAL219691115E3
8.4	4	7.0 x 15.0	3 pin	B3	14.5	2.5	70	0.03	15.0	45.0	27.6	60	MAL219691116E3
1.4	15	12.0 x 2.5	3 pin	B3	3.2	5.0	85	0.12	0.6	2.5	17.5	100	MAL219691211E3
2.8	15	12.0 x 5.0	3 pin	B3	5.8	5.0	85	0.12	1.2	5.0	35.0	100	MAL219691212E3
4.2	15	12.0 x 7.5	3 pin	B3	8.0	5.0	85	0.12	1.8	7.5	52.5	80	MAL219691213E3
5.6	15	12.0 x 10.0	3 pin	B3	11.0	5.0	85	0.12	2.4	10.0	70.0	90	MAL219691214E3
7.0	15	12.0 x 12.5	3 pin	B3	13.0	5.0	85	0.12	3.0	12.5	87.5	40	MAL219691215E3
8.4	15	12.0 x 15.0	3 pin	B3	16.0	5.0	85	0.12	3.6	15.0	105.0	40	MAL219691216E3



ELECTRICAL DATA AND ORDERING INFORMATION													
U _R (V)	C _R (F)	NOMINAL CASE SIZE Ø D x L D x L x H (mm)	CASE CODE	FOR M	F (mm)	F1 (mm)	UCT (°C)	I _L 24 h (mA)	ESR AC ⁽¹⁾ 1 kHz (Ω)	ESR DC ⁽²⁾ (Ω)	MIN. STORAGE ENERGY (Ws)	PACKAGING QUANTITIES	ORDERING CODE
SURFACE MOUNT FLAT CONFIGURATION (SMF)													
1.4	4	7.0 x 7.0 x 2.5	2 pin	C	-	-	70	0.03	2.5	7.5	4.6	50	MAL219691131E3
1.4	15	12.0 x 12.0 x 2.5	2 pin	C	-	-	85	0.12	0.6	2.5	17.5	100	MAL219691231E3
1.4	4	7.0 x 7.0 x 2.5	2 pin	D1	-	-	70	0.03	2.5	7.5	4.6	50	MAL219691141E3
1.4	15	12.0 x 12.0 x 2.5	2 pin	D2	-	-	85	0.12	0.6	2.5	17.5	100	MAL219691241E3
2.8	4	7.0 x 14.0 x 2.5	2 pin	E2	-	-	70	0.03	5.0	15.0	9.2	50	MAL219691152E3
2.8	15	12.0 x 24.0 x 2.5	2 pin	E2	-	-	85	0.12	1.2	5.0	35.0	50	MAL219691252E3
4.2	4	13.0 x 14.0 x 2.5	3 pin	E3	-	-	70	0.03	7.5	22.5	13.8	70	MAL219691153E3
4.2	15	22.0 x 24.0 x 2.5	3 pin	E3	-	-	85	0.12	1.8	7.5	52.5	35	MAL219691253E3
5.6	4	14.0 x 14.0 x 2.5	4 pin	E4	-	-	70	0.03	10.0	30.0	18.4	70	MAL219691154E3
5.6	15	24.0 x 24.0 x 2.5	4 pin	E4	-	-	85	0.12	2.4	10.0	70.0	35	MAL219691254E3
LAY FLAT CONFIGURATION (LFC)													
1.4	15	14.5 x 12.0 x 2.5	2 pin	F	-	-	85	0.12	0.6	2.5	17.5	40	MAL219691261E3
2.8	15	14.5 x 24.0 x 2.5	2 pin	F	-	-	85	0.12	1.2	5.0	35.0	40	MAL219691262E3
4.2	15	14.5 x 36.0 x 2.5	2 pin	F	-	-	85	0.12	1.8	7.5	52.5	40	MAL219691263E3
5.6	15	14.5 x 48.0 x 2.5	2 pin	F	-	-	85	0.12	2.4	10.0	70.0	20	MAL219691264E3
7.0	15	14.5 x 60.0 x 2.5	2 pin	F	-	-	85	0.12	3.0	12.5	87.5	20	MAL219691265E3
8.4	15	14.5 x 72.0 x 2.5	2 pin	F	-	-	85	0.12	3.6	15.0	105.0	20	MAL219691266E3
STACKED THROUGH HOLE OVAL													
1.4	45	25 x 15 x 2.5	3 pin	I	3.5	10	85	0.15	0.25	0.5	50.0	30	MAL219690206E3
2.8	45	25 x 15 x 5.0	3 pin	I	5	10	85	0.15	0.5	1.0	100.0	30	MAL219690203E3
4.2	45	25 x 15 x 7.5	3 pin	I	7.5	10	85	0.15	0.75	1.5	150.0	30	MAL219690201E3
5.6	45	25 x 15 x 10.0	3 pin	I	10	10	85	0.15	1.0	2.0	200.0	30	MAL219690202E3
1.4	90	35 x 25 x 5.0	3 pin	G	5	10	85	0.5	0.015	0.045	115.0	25	MAL219690106E3
2.8	90	35 x 25 x 7.5	3 pin	G	7.5	10	85	0.5	0.03	0.090	230.0	25	MAL219690103E3
4.2	90	35 x 25 x 10.0	3 pin	G	10	10	85	0.5	0.04	0.135	345.0	25	MAL219690101E3
5.6	90	35 x 25 x 15.0	3 pin	G	12.5	10	85	0.5	0.06	0.180	460.0	25	MAL219690102E3
7.0	90	35 x 25 x 17.5	3 pin	G	17.5	10	85	0.5	0.075	0.225	575.0	25	MAL219690107E3
8.4	90	35 x 25 x 20.0	3 pin	G	20.0	10	85	0.5	0.09	0.270	690.0	25	MAL219690108E3
STACKED THROUGH HOLE OVAL HORIZONTAL													
1.4	45	25 x 15 x 2.5	3 pin	K	15	10	85	0.15	0.25	0.5	50.0	30	MAL219690216E3
2.8	45	25 x 15 x 5.0	3 pin	K	15	10	85	0.15	0.5	1.0	100.0	30	MAL219690213E3
4.2	45	25 x 15 x 7.5	3 pin	K	15	10	85	0.15	0.75	1.5	150.0	30	MAL219690211E3
5.6	45	25 x 15 x 10.0	3 pin	K	15	10	85	0.15	1.0	2.0	200.0	30	MAL219690212E3
1.4	90	35 x 25 x 5.0	3 pin	H	25	10	85	0.5	0.015	0.045	115.0	25	MAL219690116E3
2.8	90	35 x 25 x 7.5	3 pin	H	25	10	85	0.5	0.03	0.090	230.0	25	MAL219690113E3
4.2	90	35 x 25 x 10.0	3 pin	H	25	10	85	0.5	0.04	0.135	345.0	25	MAL219690111E3
5.6	90	35 x 25 x 15.0	3 pin	H	25	10	85	0.5	0.06	0.180	460.0	25	MAL219690112E3
7.0	90	35 x 25 x 17.5	3 pin	H	25	10	85	0.5	0.075	0.225	575.0	25	MAL219690117E3
8.4	90	35 x 25 x 20.0	3 pin	H	25	10	85	0.5	0.09	0.270	690.0	25	MAL219690118E3

Notes

- (1) ESR AC 1 kHz are typical values
- (2) ESR DC are typical values

Table 3

LOAD CURRENTS AND VOLTAGES				
C _R (F)	RECOMMENDED CHARGE CURRENT	MAX. CHARGE CURRENT	MAX. DISCHARGE CURRENT	LOWEST DISCHARGE VOLTAGE ⁽¹⁾
4	2 mA to 8 mA	14 mA	25 mA	n x 0.8 V
15	5 mA to 20 mA	50 mA	70 mA	n x 0.8 V
45	30 mA to 300 mA	0.5 A	0.5 A	n x 0.8 V
90	0.3 A to 1 A	1.5 A	3 A	n x 0.8 V

Note

- (1) n... number of cells, permanent operation below lowest discharge voltage is not permitted

MEASURING OF CHARACTERISTICS
CAPACITANCE (C)

Capacitance shall be measured by constant current discharge method.

DISCHARGE CURRENT AS A FUNCTION OF RATED CAPACITANCE					
PARAMETER	VALUE				UNIT
Rated capacitance, C_R	4	15	45	90	F
Discharge current, I_D	4	15	45	90	mA

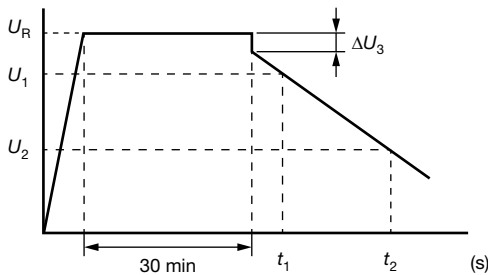

Fig. 15 - Voltage Diagram for Capacitance Measurement

Capacitance value C_R is given by discharge current I_D , time t and rated voltage U_R , according to the following equation:

- C_R Rated capacitance, in F
- U_R Rated voltage, in V
- U_1 Starting voltage, in V
- U_2 Ending voltage, in V
- ΔU_3 Voltage drop at internal resistance, in V
- t_1 Time from start of discharge until voltage U_1 is reached, in s
- t_2 Time from start of discharge until voltage U_2 is reached, in s
- I_D Discharge current, in A

$$C_R(\text{F}) = \frac{I_D(\text{A}) \times (t_2(\text{s}) - t_1(\text{s}))}{U_1(\text{V}) - U_2(\text{V})}$$

For I_D , U_1 , and U_2 the following definitions have to be used:

Table 4

CAPACITANCE						
C (F)	I_D (A)	U_R (V)	U_1 (V)	U_2 (V)	t_1 (s)	t_2 (s)
4	0.004	1.4	1.3	0.7	5	> 600
4	0.004	2.8	2.7	1.9	5	> 600
4	0.004	4.2	4.0	3.1	5	> 600
4	0.004	5.6	5.4	4.4	5	> 600
4	0.004	7.0	6.7	5.6	5	> 600
4	0.004	8.4	8.1	6.9	5	> 600
15	0.015	1.4	1.3	0.7	5	> 600
15	0.015	2.8	2.7	1.9	5	> 600
15	0.015	4.2	4.0	3.1	5	> 600
15	0.015	5.6	5.4	4.4	5	> 600
15	0.015	7.0	6.7	5.6	5	> 600
15	0.015	8.4	8.1	6.9	5	> 600

CAPACITANCE

C (F)	I_D (A)	U_R (V)	U_1 (V)	U_2 (V)	t_1 (s)	t_2 (s)
45	0.045	1.4	1.3	0.7	5	> 600
45	0.045	2.8	2.7	1.9	5	> 600
45	0.045	4.2	4.0	3.1	5	> 600
45	0.045	5.6	5.4	4.4	5	> 600
90	0.090	1.4	1.3	0.7	5	> 600
90	0.090	2.8	2.7	1.9	5	> 600
90	0.090	4.2	4.0	3.1	5	> 600
90	0.090	5.6	5.4	4.4	5	> 600
90	0.090	7.0	6.7	5.6	5	> 600
90	0.090	8.4	8.1	6.9	5	> 600

Note

- For U_2 see also Table 5

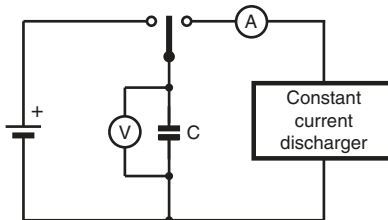
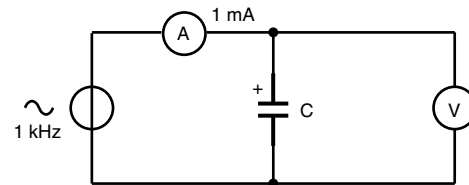

Fig. 16 - Test Circuit for Capacitance Measurement

INTERNAL RESISTANCE (R_I) AT 1 kHz

$$R_I(\Omega) = \frac{U_C(\text{V})}{10^{-3}}$$

 Fig. 17 - Test Circuit for R_I Measurement

LEAKAGE CURRENT (I_L)

Leakage current shall be measured after 30 min application of rated voltage U_R :

$$I_L(\mu\text{A}) = \frac{U_S(\text{V})}{10^{-4}}$$

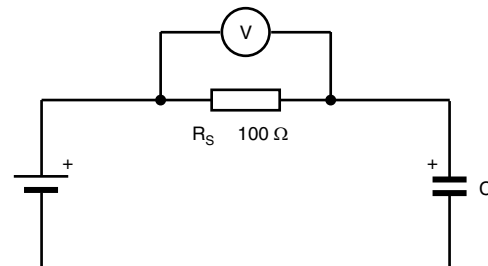

Fig. 18 - Test Circuit for Leakage Current

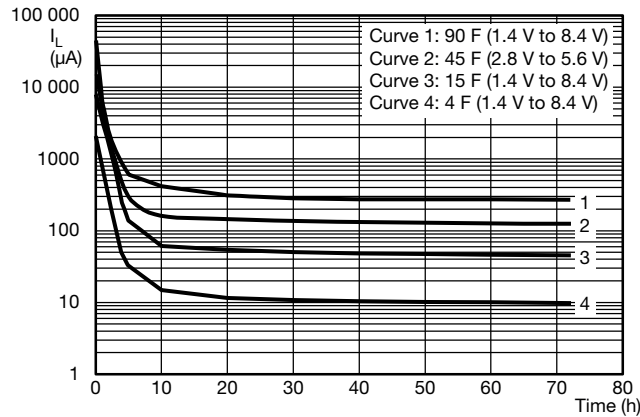

Fig. 19 - Typical Leakage Current at 20 °C as a Function of Time

Table 5

VOLTAGE TO BE USED FOR SERIES CONNECTION			
N CELLS IN SERIES	U_R (V)	U_1 (V)	U_2 (V)
1	1.4	1.3	0.7
2	2.8	2.7	1.9
3	4.2	4.0	3.1
4	5.6	5.4	4.4
5	7.0	6.7	5.6
6	8.4	8.1	6.9

DISCHARGE CHARACTERISTICS

Backup time of 196 HVC series capacitors depends on minimum memory holding voltage and discharge current (corresponding with the current consumption of the load).

For minimum backup times of standard and vertical miniaturized series see Fig. 20 to Fig. 23 (charging time ≥ 24 h and CC-CV charging according to table 3).

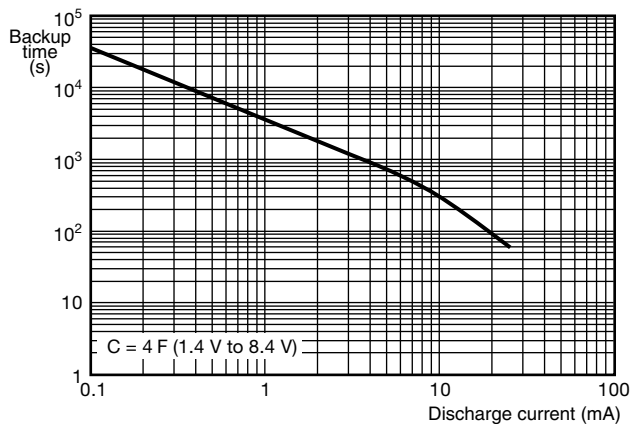

Fig. 20 - Typical Backup Time as a Function of Discharge Current

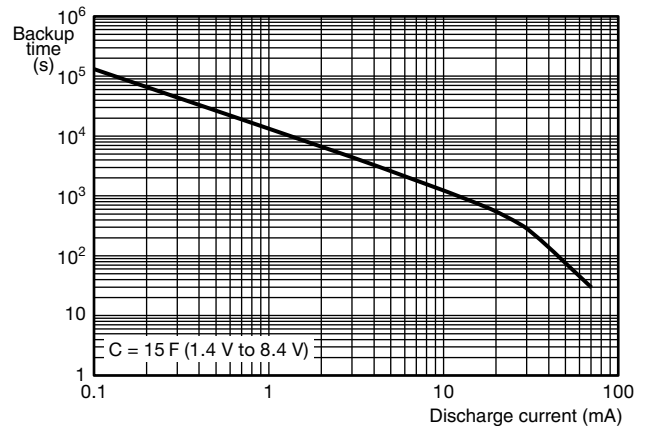

Fig. 21 - Typical Backup Time as a Function of Discharge Current

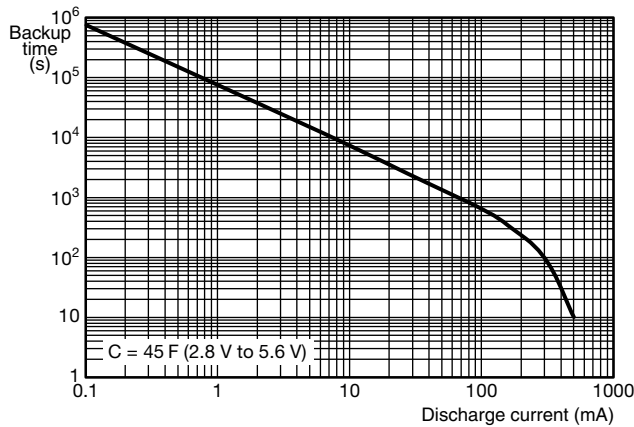

Fig. 22 - Typical Backup Time as a Function of Discharge Current

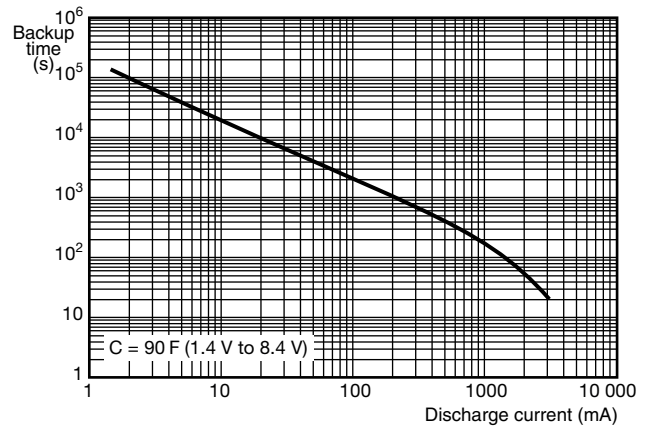

Fig. 23 - Typical Backup Time as a Function of Discharge Current

CHARGE CHARACTERISTICS

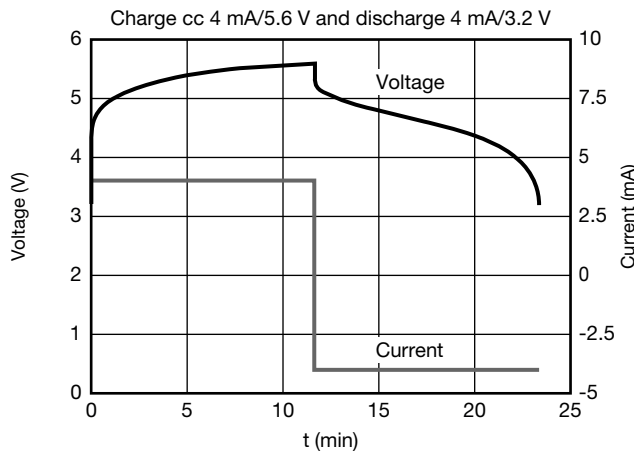

Fig. 24 - Constant Current (CC) with V-Limit Charging Method at RT
Typical Charge / Discharge Characteristics at RT: 4 F / 5.6 V

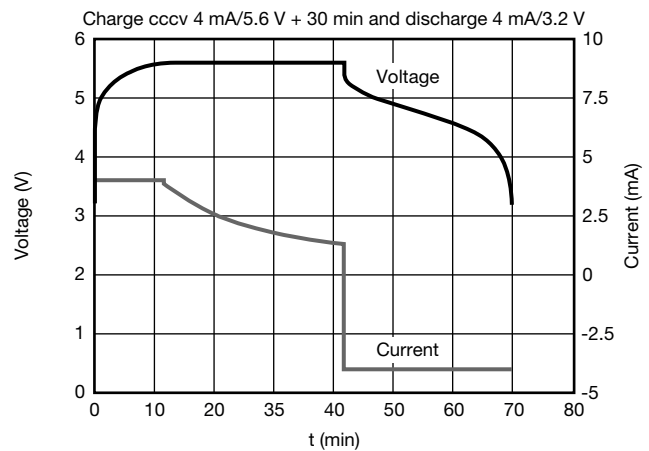

Fig. 25 - Constant Current (CC)-Constant Voltage (CV)
Charging Method at RT
Typical Charge / Discharge Characteristics at RT: 4 F / 5.6 V

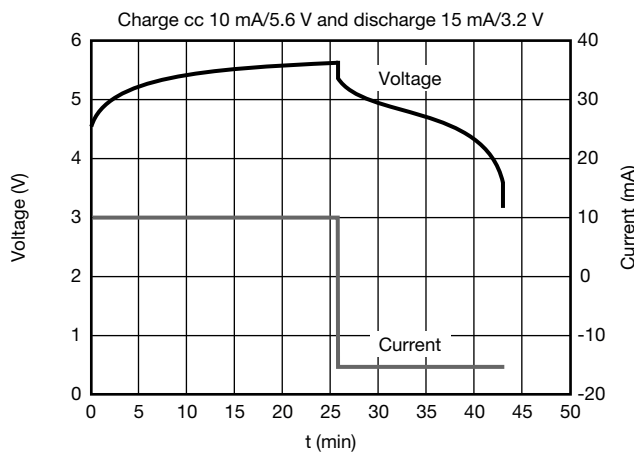

Fig. 26 - Constant Current (CC) with V-Limit Charging Method at RT
Typical Charge / Discharge Characteristics at RT: 15 F / 5.6 V

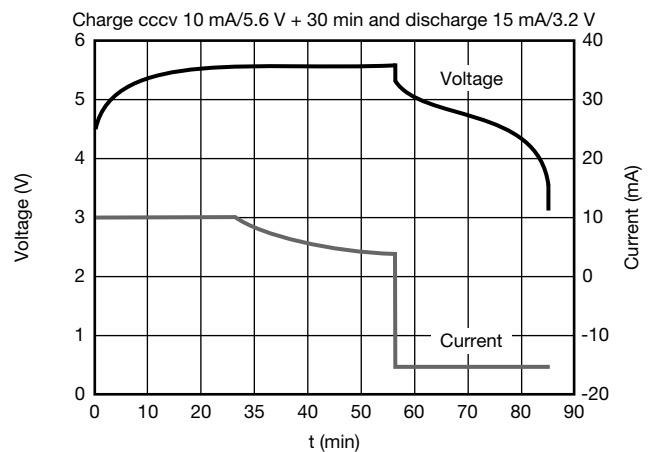

Fig. 27 - Constant Current (CC)-Constant Voltage (CV)
Charging Method at RT
Typical Charge / Discharge Characteristics at RT: 15 F / 5.6 V

Note

- Charge and discharge cycles at room temperature (RT) - maximal 50 000 cycles at room temperature allowed!

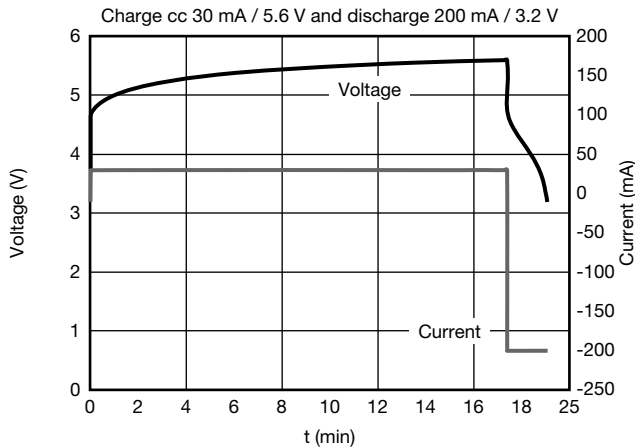

Fig. 28 - Constant Current (CC) with V-Limit Charging Method at RT
Typical Charge / Discharge Characteristics at RT: 45 F / 5.6 V

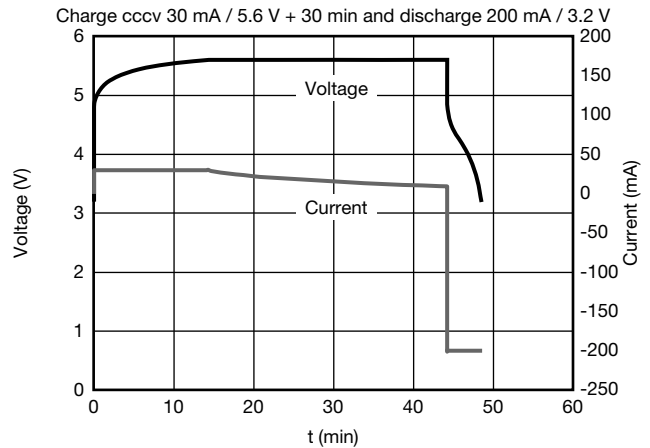

Fig. 29 - Constant Current (CC)-Constant Voltage (CV)
Charging Method at RT
Typical Charge / Discharge Characteristics at RT: 45 F / 5.6 V

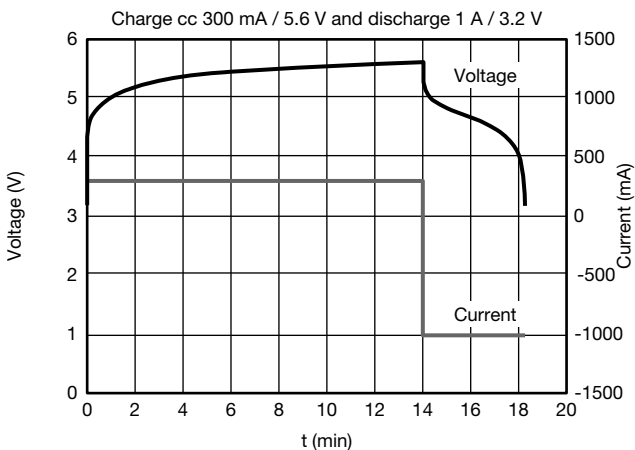

Fig. 30 - Constant Current (CC) with V-Limit Charging Method at RT
Typical Charge / Discharge Characteristics at RT: 90 F / 5.6 V

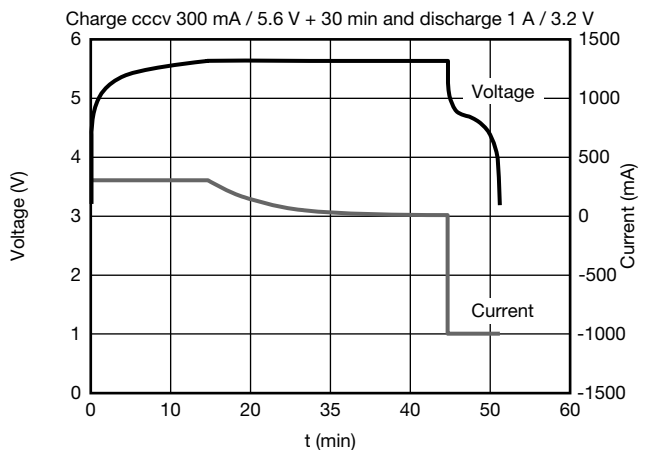

Fig. 31 - Constant Current (CC)-Constant Voltage (CV)
Charging Method at RT
Typical Charge / Discharge Characteristics at RT: 90 F / 5.6 V

Note

- Charge and discharge cycles at room temperature (RT) - maximal 50 000 cycles at room temperature allowed!

CHARGING VOLTAGE AT DIFFERENT TEMPERATURES			
OPERATING TEMPERATURE RANGE	0 °C UP TO +45 °C		+45 °C UP TO +60 °C
Charge voltage	1 cell	$U_R + 0.03 \text{ V}$	U_R
	2 cells	$U_R + 0.06 \text{ V}$	
	3 cells	$U_R + 0.09 \text{ V}$	
	> 4 cells	$U_R + 0.10 \text{ V}$	
			+60 °C UP TO +70 °C / +85 °C
			$U_R - n^{(1)} \times 0.0015 \times (T[°C] - 45)$

Notes

- Capacitor is polarized, product will be damaged if reverse charged
 - Voltages higher than specified need to be avoided; otherwise reduction of life time, internal gas generation or damage of HVC hybrid capacitor will occur
 - For other operating temperatures, a temperature derating factor has to be considered for correct charging voltage
 - Surge voltage is only allowed a few seconds per day, but not as a charging process
- (1) n... number of cells

DERATING

Working voltage at temperatures above 60 °C should be below rated voltage U_R . A derating-factor of -1.5 mV/°C per cell is recommended.

**PRODUCT AND MOUNTING CHARACTERISTICS**

Attention: parts are pre-charged at delivery - handle appropriate.

At delivery products are pre-charged and voltage over terminals is near nominal voltage. Short circuiting of product terminals is permitted. Do not short circuit permanently. Short circuiting of charged cells may heat up the cells.

For printed circuit board mounting it has to be taken into account, that for certain form factors top and bottom of products may not be insulated.

Capacitor disposal methods should be in accordance with local and state regulations.

Table 6.1

TEST PROCEDURES AND REQUIREMENTS			
NAME OF TEST	ENYCAP TESTS SUBCLAUSE	PROCEDURE (quick reference)	REQUIREMENTS (2)
Damp heat, steady state	4.12	500 h at 55 °C; RH 90 % to 95 %; no voltage applied	$\Delta C/C: \pm 30 \%$ $R_I \leq 4 \times \text{spec. limit}$ $I_L \leq 2 \times \text{spec. limit}$
Endurance	4.13.1	$T_{\text{amb}} = 70 \text{ °C} / 85 \text{ °C}$; rated voltage U_R applied; 4.0 F, 15 F: 1000 h 45 F, 90 F: 2000 h	$\Delta C/C: \pm 30 \%$ $R_I \leq 4 \times \text{spec. limit}$ $I_L \leq 2 \times \text{spec. limit}$
Useful life	4.13.2	$T_{\text{amb}} = 70 \text{ °C} / 85 \text{ °C}$; rated voltage U_R applied; 4.0 F, 15 F: 1000 h 45 F, 90 F: 2000 h	$\Delta C/C: \pm 30 \%$ $R_I \leq 4 \times \text{spec. limit}$ $I_L \leq 2 \times \text{spec. limit}$
Storage at upper category temperature	4.17	$T_{\text{amb}} = 70 \text{ °C} / 85 \text{ °C}$; no voltage applied; 1000 h	$\Delta C/C: \pm 30 \%$ $R_I \leq 4 \times \text{spec. limit}$ $I_L \leq 2 \times \text{spec. limit}$
Self discharge	4.1.5	24 h storage at room temperature after application of U_R for 1 h	Remaining voltage: $\geq (U_R \times 0.9)$
Characteristics at high and low temperature	4.19	Step 1: reference measurement at 20 °C of C , R_I , and I_L Step 2: measurement at -20 °C Step 3: measurement at +20 °C Step 4: measurement at +70 °C Step 5: measurement at +20 °C	$\Delta C/C: \pm 30 \%$ of +20 °C value $R_I \leq 5 \times \text{the } +20 \text{ °C value}$ $I_L \leq 4 \times \text{the } +20 \text{ °C value}$
Surge voltage	4.15	Max. 30 s at room temperature $U_S = n^{(1)} \times 1.6 \text{ V}$	No change of parameter! After surge voltage, discharge product below rated voltage

Notes

(1) n... number of cells

(2) R_I equals ESR_{AC} or ESR_{DC}

Table 6.2: Stacked Through Hole configuration (STH), Surface Mount Flat configuration (SMF), and Lay Flat configuration with Connector

TEST PROCEDURES AND REQUIREMENTS			
NAME OF TEST	ENYCAP TESTS SUBCLAUSE	PROCEDURE (quick reference)	REQUIREMENTS (1)
Robustness of terminations	4.4	Tensile strength; application of load force in pin / tab direction for 10 s: 10 N: for product size $\varnothing \geq 8 \text{ mm}$ 5 N: for product size $\varnothing < 8 \text{ mm}$	No breaks
Resistance to soldering heat	4.5	260 °C; 5 s	$\Delta C/C: \pm 10 \%$ R_I and $I_L \leq \text{spec. limit}$
Solderability	4.6	Solder bath; 236 °C; 2 s; one pin immersed	$\geq 75 \%$ tinning
Vibration	4.8	10 Hz to 55 Hz; 1.5 mm; 3 directions; 2 h per direction	$\Delta C/C: \pm 10 \%$ R_I and $I_L \leq \text{spec. limit}$

Notes

- Robustness - bending limited to $\pm 15^\circ$, force in direction of tab / pin, no twisting allowed
- Solder bath test: max. allowed case temperature during test is e.g. 85 °C or immersion of one (1) pad only
- Wave soldering allowed

(1) R_I equals ESR_{AC} or ESR_{DC}



SOLDERING

As a general principle, temperature and duration shall be the minimum necessary required to ensure good soldering connections. However, the maximum specified soldering time and case temperature should never be exceeded.

EVALUATION KIT

Evaluation kits are available under ordering code: MAL219699001E3. The engineering kit includes a charge and discharge demo board with different 196 HVC capacitor samples.

For further details, please contact hybridstorage@vishay.com.

Statements about product lifetime are based on calculations and internal testing. They should only be interpreted as estimations. Also due to external factors, the lifetime in the field application may deviate from the calculated lifetime. In general, nothing stated herein shall be construed as a guarantee of durability.



Disclaimer

ALL PRODUCT, PRODUCT SPECIFICATIONS AND DATA ARE SUBJECT TO CHANGE WITHOUT NOTICE TO IMPROVE RELIABILITY, FUNCTION OR DESIGN OR OTHERWISE.

Vishay Intertechnology, Inc., its affiliates, agents, and employees, and all persons acting on its or their behalf (collectively, "Vishay"), disclaim any and all liability for any errors, inaccuracies or incompleteness contained in any datasheet or in any other disclosure relating to any product.

Vishay makes no warranty, representation or guarantee regarding the suitability of the products for any particular purpose or the continuing production of any product. To the maximum extent permitted by applicable law, Vishay disclaims (i) any and all liability arising out of the application or use of any product, (ii) any and all liability, including without limitation special, consequential or incidental damages, and (iii) any and all implied warranties, including warranties of fitness for particular purpose, non-infringement and merchantability.

Statements regarding the suitability of products for certain types of applications are based on Vishay's knowledge of typical requirements that are often placed on Vishay products in generic applications. Such statements are not binding statements about the suitability of products for a particular application. It is the customer's responsibility to validate that a particular product with the properties described in the product specification is suitable for use in a particular application. Parameters provided in datasheets and / or specifications may vary in different applications and performance may vary over time. All operating parameters, including typical parameters, must be validated for each customer application by the customer's technical experts. Product specifications do not expand or otherwise modify Vishay's terms and conditions of purchase, including but not limited to the warranty expressed therein.

Except as expressly indicated in writing, Vishay products are not designed for use in medical, life-saving, or life-sustaining applications or for any other application in which the failure of the Vishay product could result in personal injury or death. Customers using or selling Vishay products not expressly indicated for use in such applications do so at their own risk. Please contact authorized Vishay personnel to obtain written terms and conditions regarding products designed for such applications.

No license, express or implied, by estoppel or otherwise, to any intellectual property rights is granted by this document or by any conduct of Vishay. Product names and markings noted herein may be trademarks of their respective owners.

Mouser Electronics

Authorized Distributor

Click to View Pricing, Inventory, Delivery & Lifecycle Information:

Vishay:

[MAL219691214E3](#) [MAL219691124E3](#) [MAL219691226E3](#) [MAL219691105E3](#) [MAL219691213E3](#) [MAL219691223E3](#)
[MAL219691215E3](#) [MAL219690103E3](#) [MAL219691263E3](#) [MAL219691201E3](#) [MAL219691115E3](#) [MAL219691202E3](#)
[MAL219691152E3](#) [MAL219691102E3](#) [MAL219691216E3](#) [MAL219691116E3](#) [MAL219691266E3](#) [MAL219691104E3](#)
[MAL219691204E3](#) [MAL219691154E3](#) [MAL219691206E3](#) [MAL219691212E3](#) [MAL219691112E3](#) [MAL219691222E3](#)
[MAL219691114E3](#) [MAL219691123E3](#) [MAL219691103E3](#) [MAL219691265E3](#) [MAL219691254E3](#) [MAL219691153E3](#)
[MAL219691225E3](#) [MAL219690102E3](#) [MAL219691252E3](#) [MAL219691211E3](#) [MAL219691205E3](#) [MAL219691203E3](#)
[MAL219691113E3](#) [MAL219691101E3](#) [MAL219691122E3](#) [MAL219691126E3](#) [MAL219691141E3](#) [MAL219691224E3](#)
[MAL219691121E3](#) [MAL219691106E3](#) [MAL219691125E3](#) [MAL219691253E3](#) [MAL219690101E3](#) [MAL219691261E3](#)
[MAL219691241E3](#) [MAL219691264E3](#) [MAL219691231E3](#) [MAL219691131E3](#) [MAL219691262E3](#) [MAL219691111E3](#)
[MAL219691221E3](#) [MAL219690201E3](#) [MAL219690202E3](#) [MAL219690112E3](#) [MAL219690111E3](#) [MAL219690113E3](#)
[MAL219690211E3](#) [MAL219690106E3](#) [MAL219695451E3](#) [MAL219695602E3](#) [MAL219695301E3](#) [MAL219695302E3](#)
[MAL219695305E3](#) [MAL219695605E3](#) [MAL219695455E3](#) [MAL219695452E3](#) [MAL219695601E3](#) [MAL219690213E3](#)
[MAL219690116E3](#) [MAL219690107E3](#) [MAL219690118E3](#) [MAL219690212E3](#) [MAL219690117E3](#) [MAL219690108E3](#)
[MAL219690203E3](#) [MAL219690998E3](#)