

## LM7121 235-MHz Tiny Low Power Voltage Feedback Amplifier

### 1 Features

- (Typical Unless Otherwise Noted).  $V_S = \pm 15\text{ V}$
- Easy to use Voltage Feedback Topology
- Stable with Unlimited Capacitive Loads
- Tiny SOT23-5 Package — Typical Circuit Layout Takes Half the Space Of SO-8 Designs
- Unity Gain Frequency: 175 MHz
- Bandwidth ( $-3\text{ dB}$ ,  $A_V = +1$ ,  $R_L = 100\Omega$ ): 235 MHz
- Slew Rate: 1300V/ $\mu\text{s}$
- Supply Voltages:
  - SO-8: 5 V to  $\pm 15\text{ V}$
  - SOT23-5: 5 V to  $\pm 5\text{ V}$
- Characterized for: +5 V,  $\pm 5\text{ V}$ ,  $\pm 15\text{ V}$
- Low Supply Current: 5.3 mA

### 2 Applications

- Scanners, Color Fax, Digital Copiers
- PC Video Cards
- Cable Drivers
- Digital Cameras
- ADC/DAC Buffers
- Set-top Boxes

### 3 Description

The LM7121 is a high performance operational amplifier which addresses the increasing AC performance needs of video and imaging applications, and the size and power constraints of portable applications.

The LM7121 can operate over a wide dynamic range of supply voltages, from 5 V (single supply) up to  $\pm 15\text{ V}$  (see [Application and Implementation](#) for more details). It offers an excellent speed-power product delivering 1300 V/ $\mu\text{s}$  and 235 MHz Bandwidth ( $-3\text{ dB}$ ,  $A_V = +1$ ). Another key feature of this operational amplifier is stability while driving unlimited capacitive loads.

Due to its tiny SOT23-5 package, the LM7121 is ideal for designs where space and weight are the critical parameters. The benefits of the tiny package are evident in small portable electronic devices, such as cameras, and PC video cards. Tiny amplifiers are so small that they can be placed anywhere on a board close to the signal source or near the input to an A/D converter.

#### Device Information<sup>(1)</sup>

PART NUMBER	PACKAGE	BODY SIZE (NOM)
LM7121	SOT-23 (5)	2.921 mm x 1.651 mm
	SOIC (8)	4.902 mm x 3.912 mm

(1) For all available packages, see the orderable addendum at the end of the datasheet.

Typical Circuit for  $A_V = +1$  Operation  
( $V_S = 6\text{ V}$ )

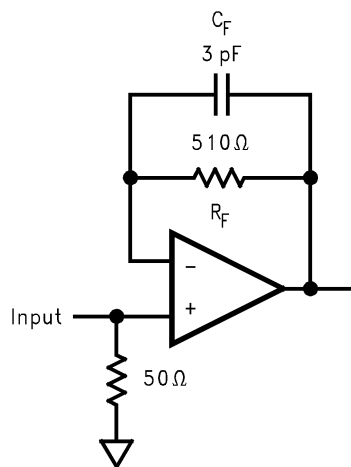

Unity Gain Frequency vs. Supply Voltage

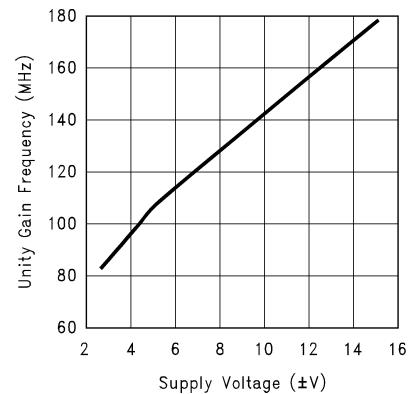

## Table of Contents

<b>1 Features</b> .....	<b>1</b>	6.8 ±5V AC Electrical Characteristics .....	<b>7</b>
<b>2 Applications</b> .....	<b>1</b>	6.9 +5V DC Electrical Characteristics .....	<b>8</b>
<b>3 Description</b> .....	<b>1</b>	6.10 +5V AC Electrical Characteristics .....	<b>8</b>
<b>4 Revision History</b> .....	<b>2</b>	6.11 Typical Characteristics .....	<b>9</b>
<b>5 Pin Configuration and Functions</b> .....	<b>3</b>	<b>7 Application and Implementation</b> .....	<b>21</b>
<b>6 Specifications</b> .....	<b>4</b>	7.1 Application Information .....	<b>21</b>
6.1 Absolute Maximum Ratings .....	<b>4</b>	7.2 Typical Applications .....	<b>22</b>
6.2 Handling Ratings .....	<b>4</b>	<b>8 Device and Documentation Support</b> .....	<b>26</b>
6.3 Recommended Operating Conditions .....	<b>4</b>	8.1 Trademarks .....	<b>26</b>
6.4 Thermal Information .....	<b>4</b>	8.2 Electrostatic Discharge Caution .....	<b>26</b>
6.5 ±15V DC Electrical Characteristics .....	<b>5</b>	8.3 Glossary .....	<b>26</b>
6.6 ±15V AC Electrical Characteristics .....	<b>6</b>	<b>9 Mechanical, Packaging, and Orderable Information</b> .....	<b>26</b>
6.7 ±5V DC Electrical Characteristics .....	<b>6</b>		

## 4 Revision History

NOTE: Page numbers for previous revisions may differ from page numbers in the current version.

<b>Changes from Original (August 1999) to Revision A</b>	<b>Page</b>
• Added, updated, or renamed the following sections: Device Information Table, <i>Pin Configuration and Functions</i> , <i>Application and Implementation</i> ; <i>Power Supply Recommendations</i> ; <i>Layout</i> ; <i>Device and Documentation Support</i> ; <i>Mechanical, Packaging, and Ordering Information</i> .....	<b>1</b>
• Deleted $T_J = 25^\circ\text{C}$ from Electrical Characteristics tables .....	<b>5</b>

## 5 Pin Configuration and Functions

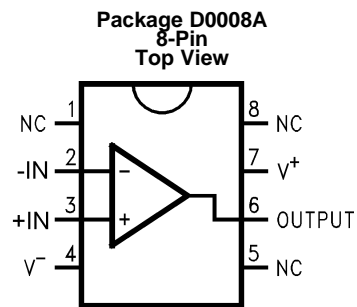
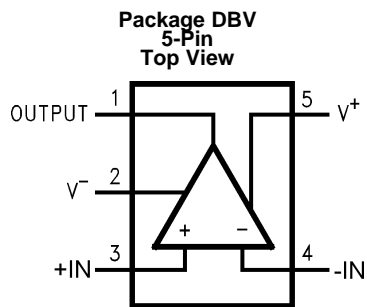

### Pin Functions

NAME	PIN		I/O	DESCRIPTION
	NUMBER			
	DBV	D0008A		
-IN	4	2	I	Inverting input
+IN	3	3	I	Non-inverting input
N/C	—	5, 8	—	No connection
OUTPUT	1	6	O	Output
V <sup>-</sup>	2	4	I	Negative supply
V <sup>+</sup>	5	7	I	Positive supply

## 6 Specifications

### 6.1 Absolute Maximum Ratings<sup>(1)</sup>

over operating free-air temperature range (unless otherwise noted)<sup>(1)</sup>

	MIN	MAX	UNIT
Differential Input Voltage <sup>(2)</sup>		±2	V
Voltage at Input/Output Pins		(V+)-1.4, (V-)+1.4	V
Supply Voltage (V+-V-)		36	V
Output Short Circuit to Ground <sup>(3)</sup>		Continuous	
Lead Temperature (soldering, 10 sec)		260	°C
Junction Temperature <sup>(4)</sup>		150	°C

- (1) Stresses beyond those listed under *Absolute Maximum Ratings* may cause permanent damage to the device. These are stress ratings only, which do not imply functional operation of the device at these or any other conditions beyond those indicated under *Recommended Operating Conditions*. Exposure to absolute-maximum-rated conditions for extended periods may affect device reliability.
- (2) Applies to both single-supply and split-supply operation. Continuous short circuit operation at elevated ambient temperature can result in exceeding the maximum allowed junction temperature of 150°C.
- (3) The maximum power dissipation is a function of  $T_{J(max)}$ ,  $R_{\theta JA}$ , and  $T_A$ . The maximum allowable power dissipation at any ambient temperature is  $P_D = (T_{J(max)} - T_A) / R_{\theta JA}$ . All numbers apply for packages soldered directly into a PC board.
- (4) Typical Values represent the most likely parametric norm.

### 6.2 Handling Ratings

			MIN	MAX	UNIT
$T_{stg}$	Storage temperature range		-65	+150	°C
$V_{(ESD)}$	Electrostatic discharge	Human body model (HBM), per ANSI/ESDA/JEDEC JS-001, all pins <sup>(1)</sup>		2000	V

- (1) JEDEC document JEP155 states that 2000-V HBM allows safe manufacturing with a standard ESD control process. Human body model, 1.5 k in series with 100 pF.

### 6.3 Recommended Operating Conditions

over operating free-air temperature range (unless otherwise noted)

	MIN	NOM	MAX	UNIT
Operating Temperature Range	-40		85	°C

### 6.4 Thermal Information

THERMAL METRIC <sup>(1)</sup>		D0008A (8)	DBV (5)	UNIT
$R_{\theta JA}$	Junction-to-ambient thermal resistance	165	325	°C/W

- (1) For more information about traditional and new thermal metrics, see the *IC Package Thermal Metrics* application report, [SPRA953](#).

## 6.5 ±15V DC Electrical Characteristics

Unless otherwise specified, all limits ensured for  $V^+ = +15V$ ,  $V^- = -15V$ ,  $V_{CM} = V_O = 0V$  and  $R_L > 1M\Omega$ . **Boldface** limits apply at the temperature extremes.

PARAMETER		TEST CONDITIONS	TYP <sup>(1)</sup>	LM7121 LIMIT <sup>(2)</sup>	UNIT
$V_{OS}$	Input Offset Voltage		0.9	8 <b>15</b>	mV max
$I_B$	Input Bias Current		5.2	9.5 <b>12</b>	$\mu A$ max
$I_{OS}$	Input Offset Current		0.04	4.3 <b>7</b>	$\mu A$ max
$R_{IN}$	Input Resistance	Common Mode	10		$M\Omega$
		Differential Mode	3.4		$M\Omega$
$C_{IN}$	Input Capacitance	Common Mode	2.3		pF
CMRR	Common Mode Rejection Ratio	$-10V \leq V_{CM} \leq 10V$	93	73 <b>70</b>	dB min
+PSRR	Positive Power Supply Rejection Ratio	$10V \leq V^+ \leq 15V$	86	70 <b>68</b>	dB min
-PSRR	Negative Power Supply Rejection Ratio	$-15V \leq V^- \leq -10V$	81	68 <b>65</b>	dB min
$V_{CM}$	Input Common-Mode Voltage Range	CMRR $\geq 70$ dB	13	11	V min
			-13	-11	V max
$A_V$	Large Signal Voltage Gain	$R_L = 2k\Omega$ , $V_O = 20V_{PP}$	72	65 <b>57</b>	dB min
$V_O$	Output Swing	$R_L = 2k\Omega$	13.4	11.1 <b>10.8</b>	V min
			-13.4	-11.2 <b>-11.0</b>	V max
		$R_L = 150\Omega$	10.2	7.75 <b>7.0</b>	V min
			-7.0	-5.0 <b>-4.8</b>	V max
$I_{SC}$	Output Short Circuit Current	Sourcing	71	54 <b>44</b>	mA min
		Sinking	52	39 <b>34</b>	mA min
$I_S$	Supply Current		5.3	6.6 <b>7.5</b>	mA max

(1) Typical Values represent the most likely parametric norm.

(2) All limits are ensured by testing or statistical analysis.

## 6.6 ±15V AC Electrical Characteristics

Unless otherwise specified, all limits ensured for  $V_+ = 15V$ ,  $V_- = -15V$ ,  $V_{CM} = V_O = 0V$  and  $R_L > 1M\Omega$ . **Boldface** limits apply at the temperature extremes.

PARAMETER		TEST CONDITIONS	TYP <sup>(1)</sup>	LM7121 LIMIT <sup>(2)</sup>	UNIT
SR	Slew Rate <sup>(3)</sup>	$A_V = +2$ , $R_L = 1k\Omega$ , $V_O = 20V_{PP}$	1300		V/ $\mu$ s
GBW	Unity Gain-Bandwidth	$R_L = 1k\Omega$	175		MHz
$\phi_m$	Phase Margin		63		Deg
f (-3 dB)	Bandwidth <sup>(4)(5)</sup>	$R_L = 100\Omega$ , $A_V = +1$	235		MHz
		$R_L = 100\Omega$ , $A_V = +2$	50		
$t_s$	Settling Time	10 $V_{PP}$ Step, to 0.1%, $R_L = 500\Omega$	74		ns
$t_r$ , $t_f$	Rise and Fall Time <sup>(5)</sup>	$A_V = +2$ , $R_L = 100\Omega$ , $V_O = 0.4V_{PP}$	5.3		ns
$A_D$	Differential Gain	$A_V = +2$ , $R_L = 150\Omega$	0.3%		
$\phi_D$	Differential Phase	$A_V = +2$ , $R_L = 150\Omega$	0.65		Deg
$e_n$	Input-Referred Voltage Noise	f = 10 kHz	17		nV / $\sqrt{Hz}$
$i_n$	Input-Referred Current Noise	f = 10 kHz	1.9		pA / $\sqrt{Hz}$
T.H.D.	Total Harmonic Distortion	2 $V_{PP}$ Output, $R_L = 150\Omega$ , $A_V = +2$ , f = 1 MHz	0.065%		
		2 $V_{PP}$ Output, $R_L = 150\Omega$ , $A_V = +2$ , f = 5 MHz	0.52%		

- (1) Typical Values represent the most likely parametric norm.
- (2) All limits are ensured by testing or statistical analysis.
- (3) Slew rate is the average of the rising and falling slew rates.
- (4) Unity gain operation for  $\pm 5V$  and  $\pm 15V$  supplies is with a feedback network of 510  $\Omega$  and 3 pF in parallel (see [Application and Implementation](#)). For +5V single supply operation, feedback is a direct short from the output to the inverting input.
- (5)  $A_V = +2$  operation with 2 k $\Omega$  resistors and 2 pF capacitor from summing node to ground.

## 6.7 ±5V DC Electrical Characteristics

Unless otherwise specified, all limits ensured for  $V_+ = 5V$ ,  $V_- = -5V$ ,  $V_{CM} = V_O = 0V$  and  $R_L > 1M\Omega$ . **Boldface** limits apply at the temperature extremes.

PARAMETER		TEST CONDITIONS	TYP <sup>(1)</sup>	LM7121 LIMIT <sup>(2)</sup>	UNIT
$V_{OS}$	Input Offset Voltage		1.6	8 <b>15</b>	mV max
$I_B$	Input Bias Current		5.5	9.5 <b>12</b>	$\mu$ A max
$I_{OS}$	Input Offset Current		0.07	4.3 <b>7.0</b>	$\mu$ A max
$R_{IN}$	Input Resistance	Common Mode	6.8		M $\Omega$
		Differential Mode	3.4		M $\Omega$
$C_{IN}$	Input Capacitance	Common Mode	2.3		pF
CMRR	Common Mode Rejection Ratio	$-2V \leq V_{CM} \leq 2V$	75	65 <b>60</b>	dB min
+PSRR	Positive Power Supply Rejection Ratio	$3V \leq V^+ \leq 5V$	89	65 <b>60</b>	dB min
-PSRR	Negative Power Supply Rejection Ratio	$-5V \leq V^- \leq -3V$	78	65 <b>60</b>	dB min

- (1) Typical Values represent the most likely parametric norm.
- (2) All limits are ensured by testing or statistical analysis.

### ±5V DC Electrical Characteristics (continued)

Unless otherwise specified, all limits ensured for  $V^+ = 5V$ ,  $V^- = -5V$ ,  $V_{CM} = V_O = 0V$  and  $R_L > 1M\Omega$ . **Boldface** limits apply at the temperature extremes.

PARAMETER		TEST CONDITIONS	TYP <sup>(1)</sup>	LM7121 LIMIT <sup>(2)</sup>	UNIT
$V_{CM}$	Input Common Mode Voltage Range	CMRR $\geq 60$ dB	3	2.5	V min
			-3	-2.5	V max
$A_V$	Large Signal Voltage Gain	$R_L = 2k\Omega$ , $V_O = 3V_{PP}$	66	60 <b>58</b>	dB min
$V_O$	Output Swing	$R_L = 2k\Omega$	3.62	3.0 <b>2.75</b>	V min
			-3.62	-3.0 <b>-2.70</b>	V max
		$R_L = 150\Omega$	3.1	2.5 <b>2.3</b>	V min
			-2.8	-2.15 <b>-2.00</b>	V max
$I_{SC}$	Output Short Circuit Current	Sourcing	53	38 <b>33</b>	mA min
		Sinking	29	21 <b>19</b>	mA min
$I_S$	Supply Current		5.1	6.4 <b>7.2</b>	mA max

### 6.8 ±5V AC Electrical Characteristics

Unless otherwise specified, all limits ensured for  $V^+ = 5V$ ,  $V^- = -5V$ ,  $V_{CM} = V_O = 0V$  and  $R_L > 1M\Omega$ . **Boldface** limits apply at the temperature extremes.

PARAMETER		TEST CONDITIONS	TYP <sup>(1)</sup>	LM7121 LIMIT <sup>(2)</sup>	UNIT
SR	Slew Rate <sup>(3)</sup>	$A_V = +2$ , $R_L = 1k\Omega$ , $V_O = 6V_{PP}$	520		V/ $\mu$ s
GBW	Unity Gain-Bandwidth	$R_L = 1k\Omega$	105		MHz
$\phi_m$	Phase Margin	$R_L = 1k\Omega$	74		Deg
f (-3 dB)	Bandwidth <sup>(4)(5)</sup>	$R_L = 100\Omega$ , $A_V = +1$	160		MHz
		$R_L = 100\Omega$ , $A_V = +2$	50		MHz
$t_s$	Settling Time	5 $V_{PP}$ Step, to 0.1%, $R_L = 500\Omega$	65		ns
$t_r$ , $t_f$	Rise and Fall Time <sup>(5)</sup>	$A_V = +2$ , $R_L = 100\Omega$ , $V_O = 0.4V_{PP}$	5.8		ns
$A_D$	Differential Gain	$A_V = +2$ , $R_L = 150\Omega$	0.3%		
$\phi_D$	Differential Phase	$A_V = +2$ , $R_L = 150\Omega$	0.65		Deg
$e_n$	Input-Referred Voltage Noise	f = 10 kHz	17		nV / $\sqrt{Hz}$
$i_n$	Input-Referred Current Noise	f = 10 kHz	2		pA / $\sqrt{Hz}$
T.H.D.	Total Harmonic Distortion	2 $V_{PP}$ Output, $R_L = 150\Omega$ , $A_V = +2$ , f = 1 MHz	0.1%		
		2 $V_{PP}$ Output, $R_L = 150\Omega$ , $A_V = +2$ , f = 5 MHz	0.6		

(1) Typical Values represent the most likely parametric norm.

(2) All limits are ensured by testing or statistical analysis.

(3) Slew rate is the average of the rising and falling slew rates.

(4) Unity gain operation for  $\pm 5V$  and  $\pm 15V$  supplies is with a feedback network of 510  $\Omega$  and 3 pF in parallel (see [Application and Implementation](#)). For +5V single supply operation, feedback is a direct short from the output to the inverting input.

(5)  $A_V = +2$  operation with 2 k $\Omega$  resistors and 2 pF capacitor from summing node to ground.

## 6.9 +5V DC Electrical Characteristics

Unless otherwise specified, all limits ensured for  $V^+ = +5V$ ,  $V^- = 0V$ ,  $V_{CM} = V_O = V^+/2$  and  $R_L > 1M\Omega$ . **Boldface** limits apply at the temperature extremes.

PARAMETER	TEST CONDITIONS	TYP <sup>(1)</sup>	LM7121 LIMIT <sup>(2)</sup>	UNIT
$V_{OS}$	Input Offset Voltage	2.4		mV
$I_B$	Input Bias Current	4		$\mu A$
$I_{OS}$	Input Offset Current	0.04		$\mu A$
$R_{IN}$	Input Resistance	Common Mode	2.6	M
		Differential Mode	3.4	M
$C_{IN}$	Input Capacitance	Common Mode	2.3	pF
CMRR	Common Mode Rejection Ratio	$2V \leq V_{CM} \leq 3V$	65	dB
+PSRR	Positive Power Supply Rejection Ratio	$4.6V \leq V^+ \leq 5V$	85	dB
-PSRR	Negative Power Supply Rejection Ratio	$0V \leq V^- \leq 0.4V$	61	dB
$V_{CM}$	Input Common-Mode Voltage Range	CMRR 45 dB	3.5	V min
			1.5	V max
$A_V$	Large Signal Voltage Gain	$R_L = 2k\Omega$ to $V^+/2$	64	dB
$V_O$	Output Swing	$R_L = 2k\Omega$ to $V^+/2$ , High	3.7	V
		$R_L = 2k\Omega$ to $V^+/2$ , Low	1.3	
		$R_L = 150\Omega$ to $V^+/2$ , High	3.48	
		$R_L = 150\Omega$ to $V^+/2$ , Low	1.59	
$I_{SC}$	Output Short Circuit Current	Sourcing	33	mA
		Sinking	20	mA
$I_S$	Supply Current		4.8	mA

(1) Typical Values represent the most likely parametric norm.

(2) All limits are ensured by testing or statistical analysis.

## 6.10 +5V AC Electrical Characteristics

Unless otherwise specified, all limits ensured for  $V^+ = +5V$ ,  $V^- = 0V$ ,  $V_{CM} = V_O = V^+/2$  and  $R_L > 1M\Omega$ . **Boldface** limits apply at the temperature extremes.

PARAMETER	TEST CONDITIONS	TYP <sup>(1)</sup>	LM7121 LIMIT <sup>(2)</sup>	UNIT
SR	Slew Rate <sup>(3)</sup>	$A_V = +2$ , $R_L = 1k\Omega$ to $V^+/2$ , $V_O = 1.8V_{PP}$	145	V/ $\mu s$
GBW	Unity Gain-Bandwidth	$R_L = 1k$ to $V^+/2$	80	MHz
$\phi_m$	Phase Margin	$R_L = 1k$ to $V^+/2$	70	Deg
f (-3 dB)	Bandwidth <sup>(4)(5)</sup>	$R_L = 100\Omega$ to $V^+/2$ , $A_V = +1$	200	MHz
		$R_L = 100\Omega$ to $V^+/2$ , $A_V = +2$	45	
$t_r$ , $t_f$	Rise and Fall Time <sup>(5)</sup>	$A_V = +2$ , $R_L = 100\Omega$ , $V_O = 0.2V_{PP}$	8	ns
T.H.D.	Total Harmonic Distortion	0.6 $V_{PP}$ Output, $R_L = 150\Omega$ , $A_V = +2$ , $f = 1$ MHz	0.067%	
		0.6 $V_{PP}$ Output, $R_L = 150\Omega$ , $A_V = +2$ , $f = 5$ MHz	0.33%	

(1) Typical Values represent the most likely parametric norm.

(2) All limits are ensured by testing or statistical analysis.

(3) Slew rate is the average of the rising and falling slew rates.

(4) Unity gain operation for  $\pm 5V$  and  $\pm 15V$  supplies is with a feedback network of  $510\Omega$  and  $3pF$  in parallel (see [Application and Implementation](#)). For +5V single supply operation, feedback is a direct short from the output to the inverting input.

(5)  $A_V = +2$  operation with  $2k\Omega$  resistors and  $2pF$  capacitor from summing node to ground.



### 6.11 Typical Characteristics

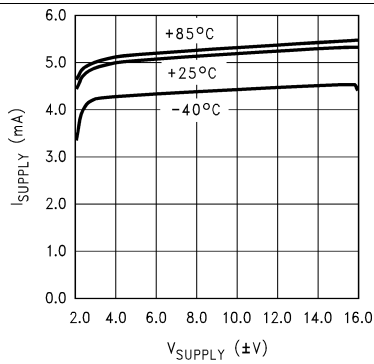

Figure 1. Supply Current vs. Supply Voltage

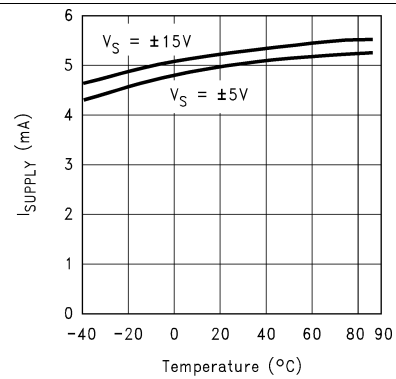

Figure 2. Supply Current vs. Temperature

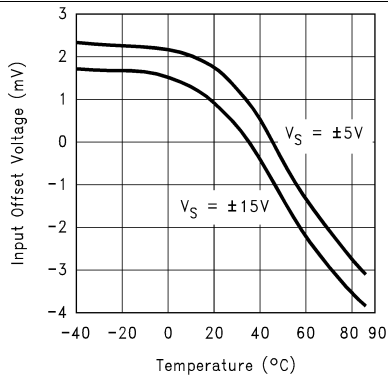

Figure 3. Input Offset Voltage vs. Temperature

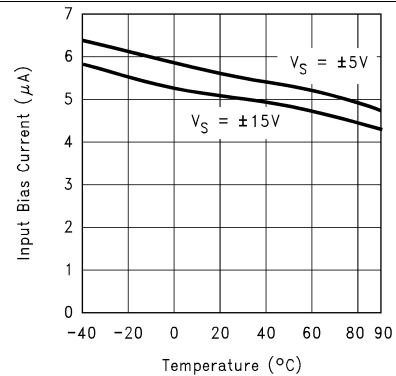

Figure 4. Input Bias Current vs. Temperature

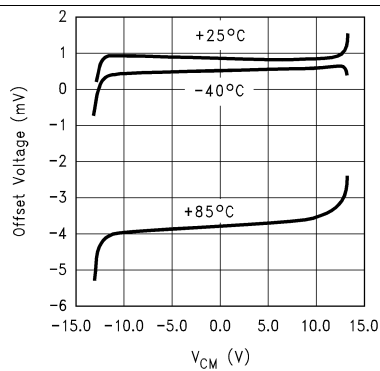

Figure 5. Input Offset Voltage vs. Common Mode Voltage at  $V_S = \pm 15\text{ V}$

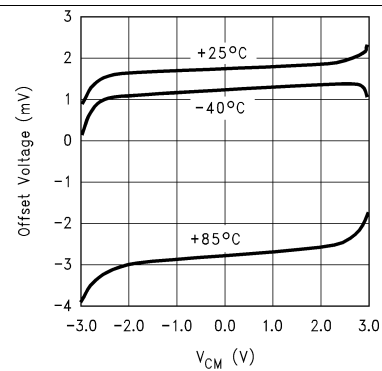

Figure 6. Input Offset Voltage vs. Common Mode Voltage at  $V_S = \pm 5\text{ V}$

Typical Characteristics (continued)

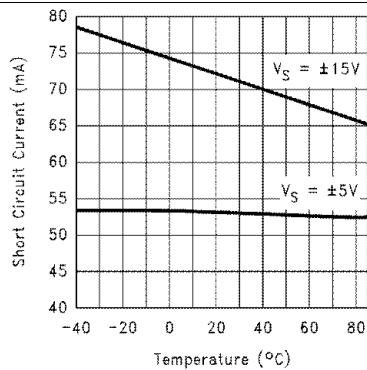

Figure 7. Short Circuit Current vs. Temperature (Sourcing)

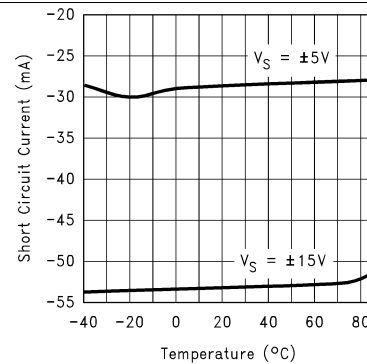

Figure 8. Short Circuit Current vs. Temperature (Sinking)

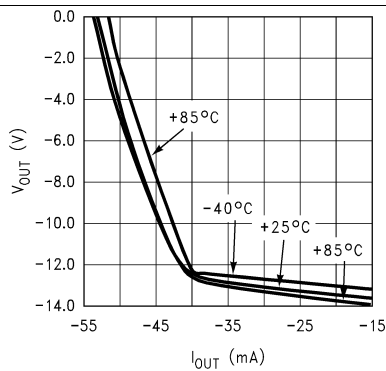

Figure 9. Output Voltage vs. Output Current (ISINK, VS = ±15 V)

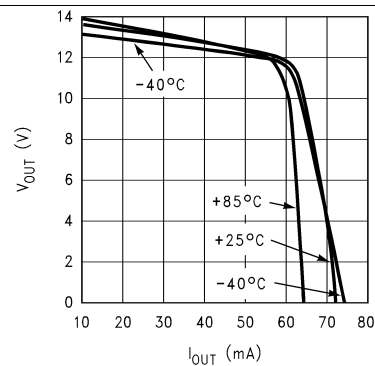

Figure 10. Output Voltage vs. Output Current (ISOURCE, VS = ±15 V)

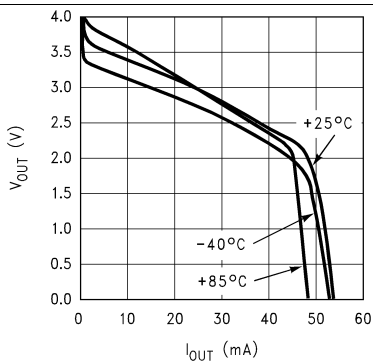

Figure 11. Output Voltage vs. Output Current (ISOURCE, VS = ±5 V)

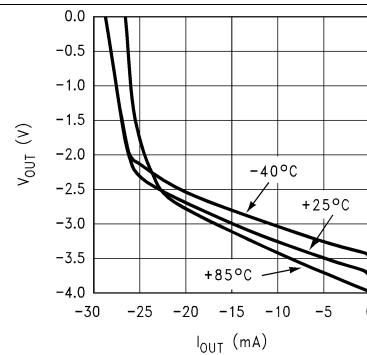

Figure 12. Output Voltage vs. Output Current (ISINK, VS = ±5 V)

Typical Characteristics (continued)

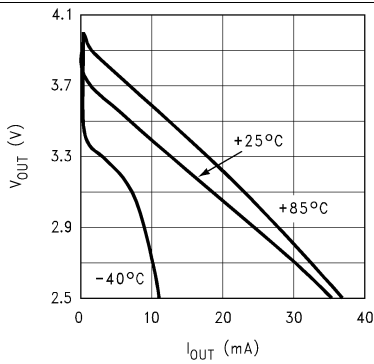

Figure 13. Output Voltage vs. Output Current (I<sub>SOURCE</sub>, V<sub>S</sub> = +5 V)

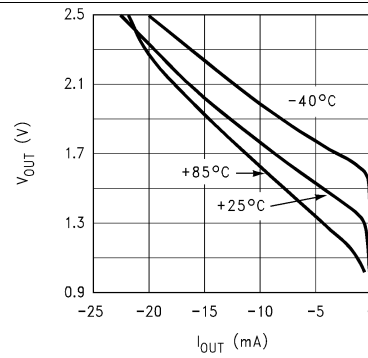

Figure 14. Output Voltage vs. Output Current (I<sub>SINK</sub>, V<sub>S</sub> = +5 V)

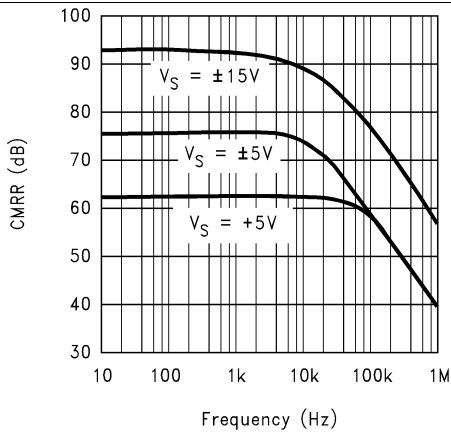

Figure 15. CMRR vs. Frequency

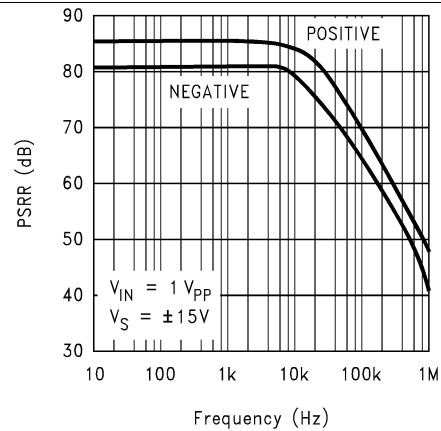

Figure 16. PSRR vs. Frequency

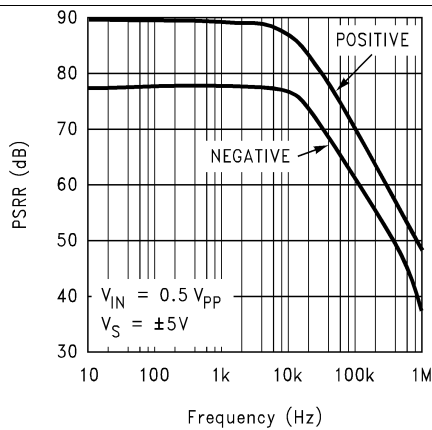

Figure 17. PSRR vs. Frequency

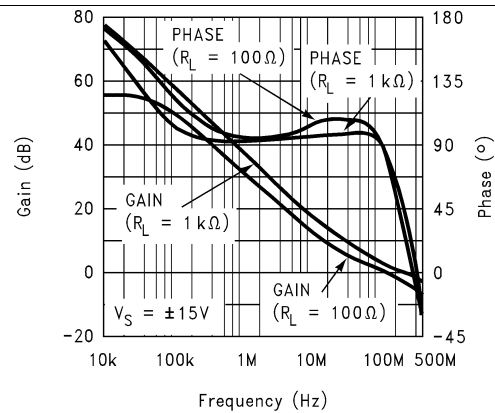

Figure 18. Open Loop Frequency Response

Typical Characteristics (continued)

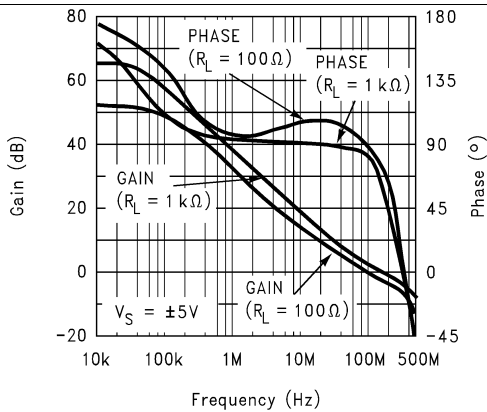

Figure 19. Open Loop Frequency Response

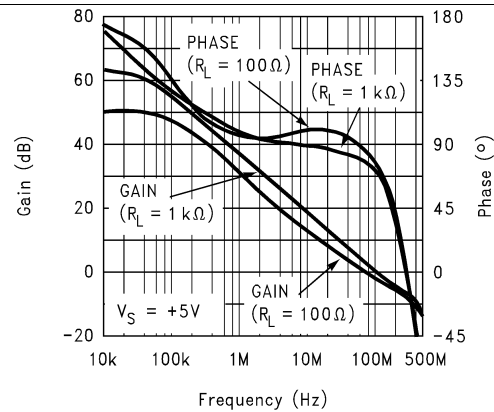

Figure 20. Open Loop Frequency Response

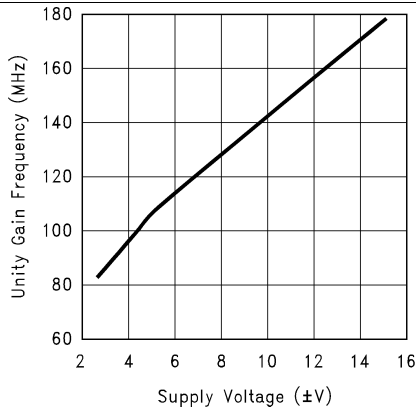

Figure 21. Unity Gain Frequency vs. Supply Voltage

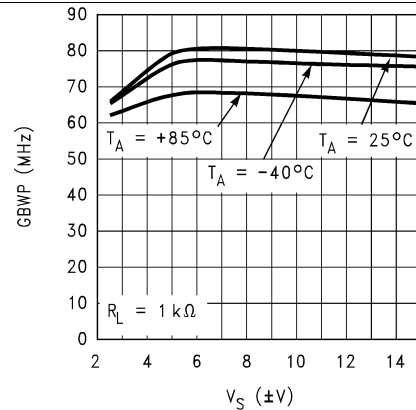

Figure 22. GBWP at 10 MHz vs. Supply Voltage

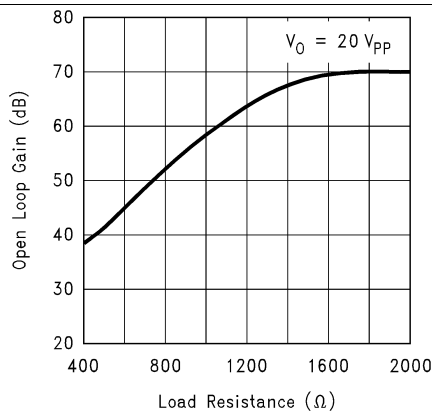

Figure 23. Large Signal Voltage Gain vs. Load,  $V_S = \pm 15 V$

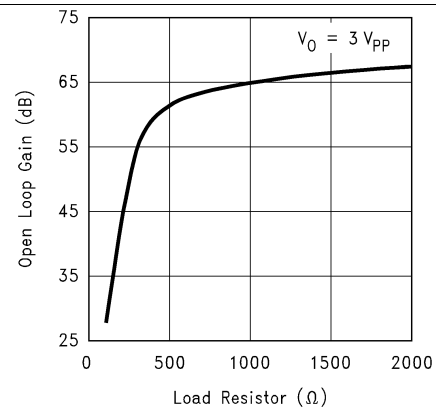

Figure 24. Large Signal Voltage Gain vs. Load,  $V_S = \pm 5 V$

Typical Characteristics (continued)

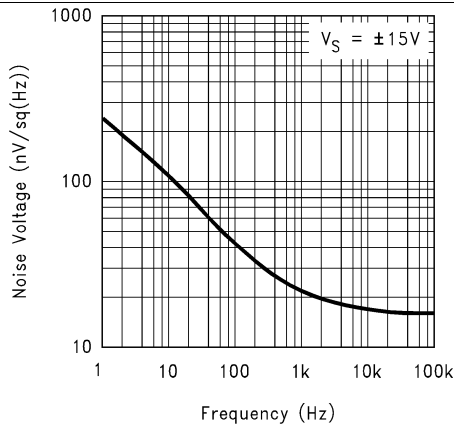

Figure 25. Input Voltage Noise vs. Frequency

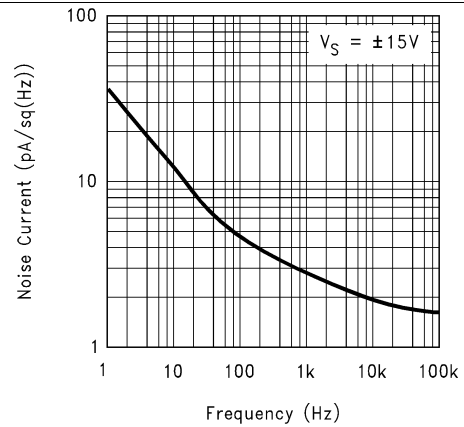

Figure 26. Input Current Noise vs. Frequency

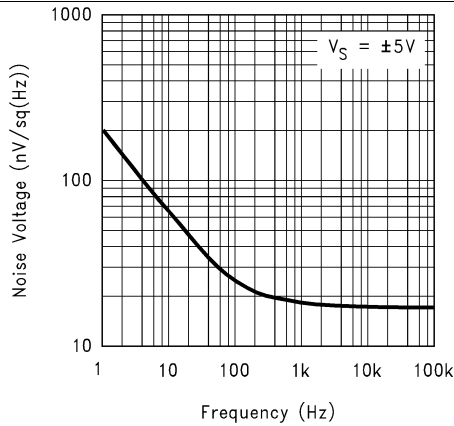

Figure 27. Input Voltage Noise vs. Frequency

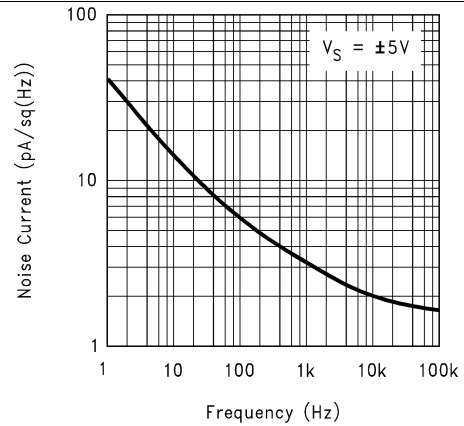

Figure 28. Input Current Noise vs. Frequency

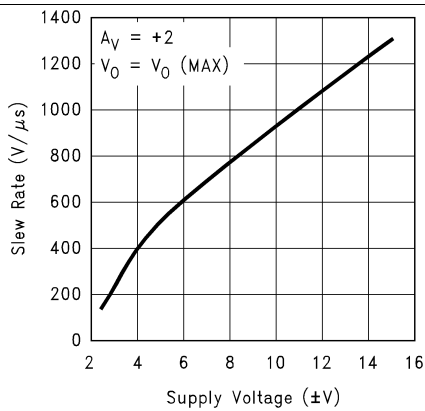

Figure 29. Slew Rate vs. Supply Voltage

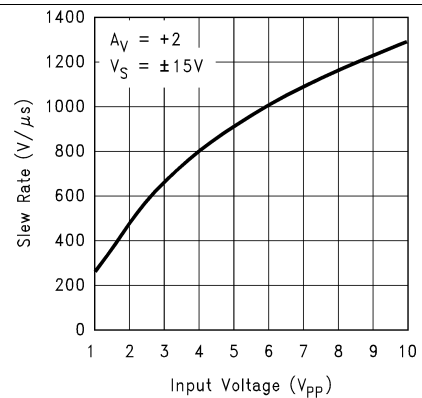

Figure 30. Slew Rate vs. Input Voltage

Typical Characteristics (continued)

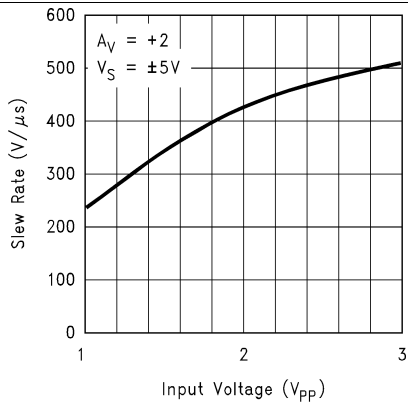

Figure 31. Slew Rate vs. Input Voltage

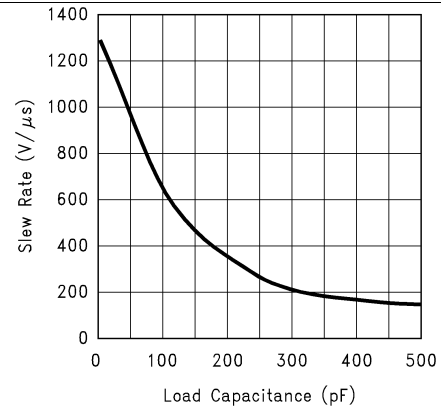

Figure 32. Slew Rate vs. Load Capacitance

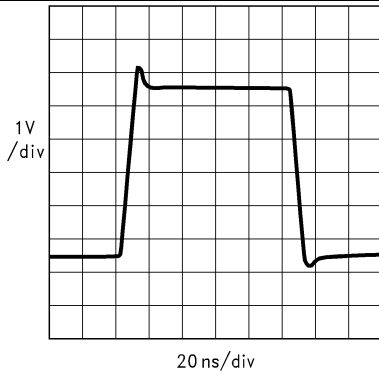

Figure 33. Large Signal Pulse Response,  
 $A_V = -1$ ,  $V_S = \pm 15$  V

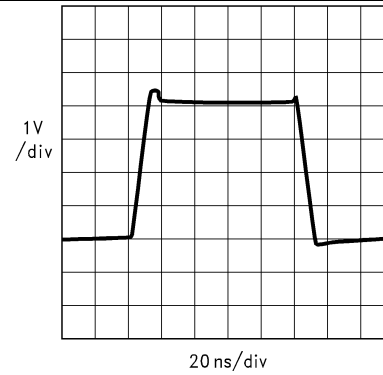

Figure 34. Large Signal Pulse Response,  
 $A_V = -1$ ,  $V_S = \pm 5$  V

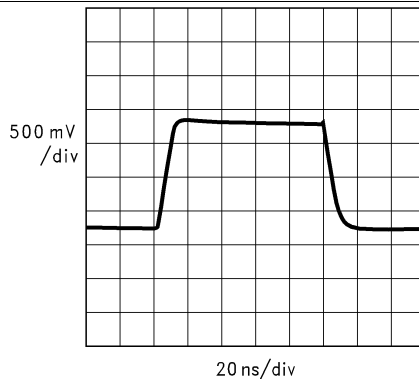

Figure 35. Large Signal Pulse Response,  
 $A_V = -1$ ,  $V_S = +5$  V

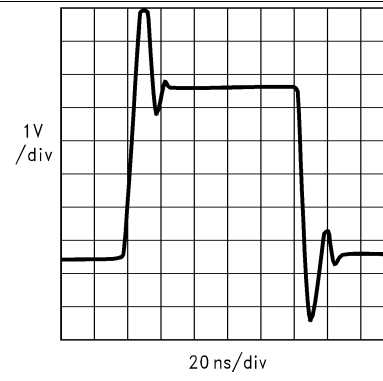

Figure 36. Large Signal Pulse Response,  
 $A_V = +1$ ,  $V_S = \pm 15$  V

Typical Characteristics (continued)

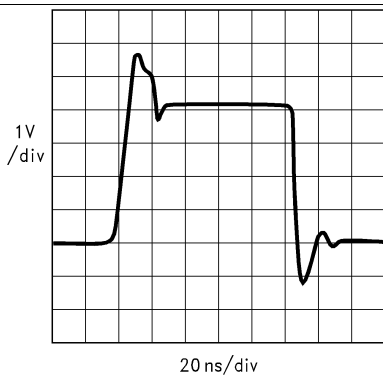

Figure 37. Large Signal Pulse Response,  
 $A_V = +1, V_S = \pm 5\text{ V}$

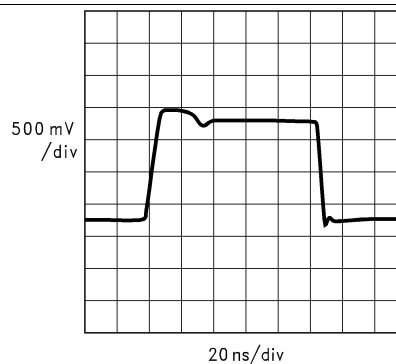

Figure 38. Large Signal Pulse Response,  
 $A_V = +1, V_S = +5\text{ V}$

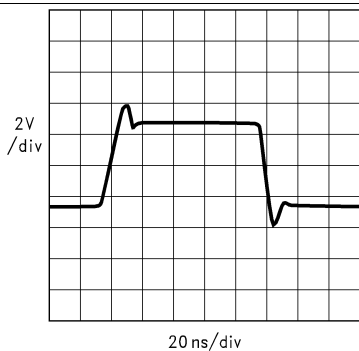

Figure 39. Large Signal Pulse Response,  
 $A_V = +2, V_S = \pm 15\text{ V}$

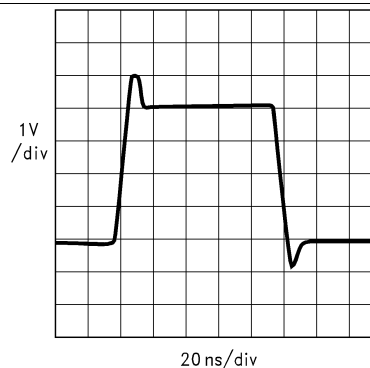

Figure 40. Large Signal Pulse Response,  
 $A_V = +2, V_S = \pm 5\text{ V}$

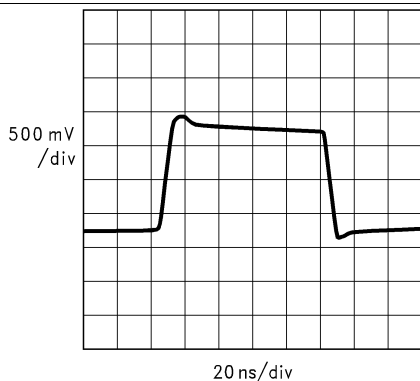

Figure 41. Large Signal Pulse Response,  
 $A_V = +2, V_S = +5\text{ V}$

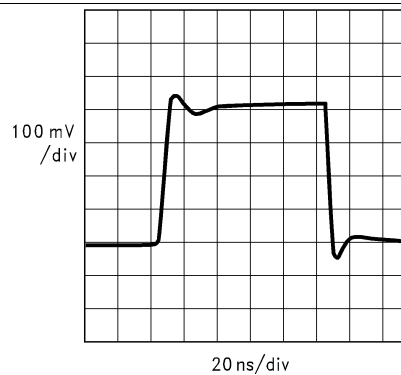

Figure 42. Small Signal Pulse Response,  
 $A_V = -1, V_S = \pm 15\text{ V}, R_L = 100\ \Omega$

Typical Characteristics (continued)

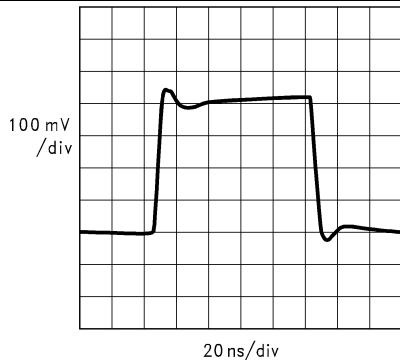

Figure 43. Small Signal Pulse Response,  
 $A_V = -1$ ,  $V_S = \pm 5\text{ V}$ ,  $R_L = 100\ \Omega$

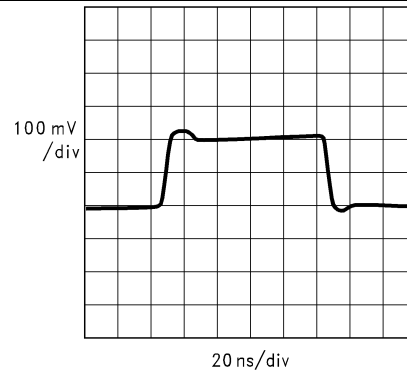

Figure 44. Small Signal Pulse Response,  
 $A_V = -1$ ,  $V_S = +5\text{ V}$ ,  $R_L = 100\ \Omega$

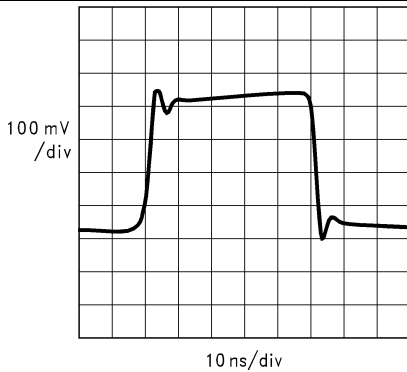

Figure 45. Small Signal Pulse Response,  
 $A_V = +1$ ,  $V_S = \pm 15\text{ V}$ ,  $R_L = 100\ \Omega$

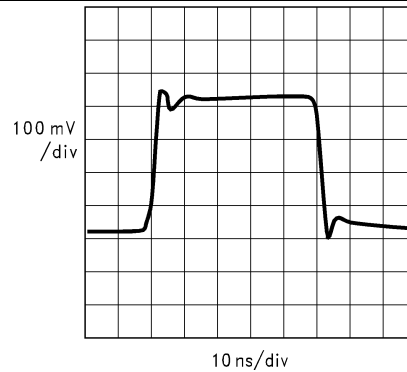

Figure 46. Small Signal Pulse Response,  
 $A_V = +1$ ,  $V_S = \pm 5\text{ V}$ ,  $R_L = 100\ \Omega$

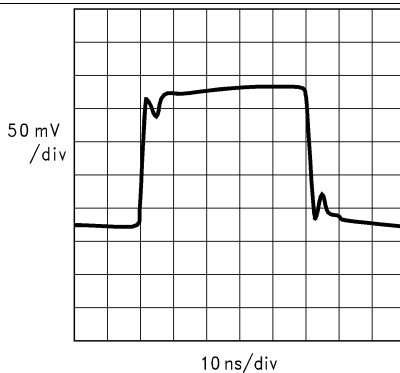

Figure 47. Small Signal Pulse Response,  
 $A_V = +1$ ,  $V_S = +5\text{ V}$ ,  $R_L = 100\ \Omega$

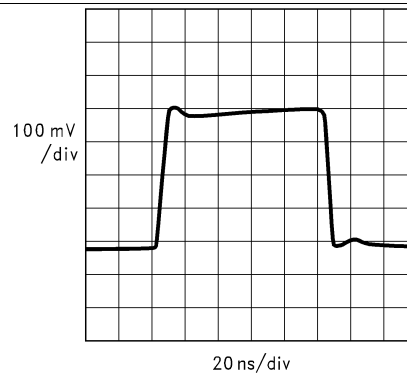

Figure 48. Small Signal Pulse Response,  
 $A_V = +2$ ,  $V_S = \pm 15\text{ V}$ ,  $R_L = 100\ \Omega$



Typical Characteristics (continued)

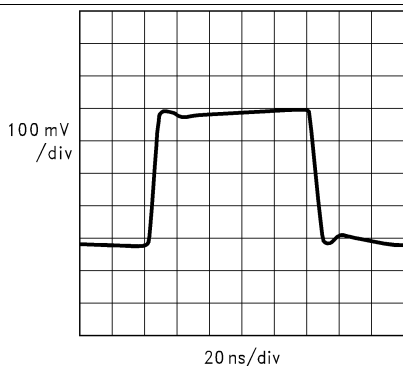

Figure 49. Small Signal Pulse Response,  $A_V = +2$ ,  $V_S = \pm 5\text{ V}$ ,  $R_L = 100\ \Omega$

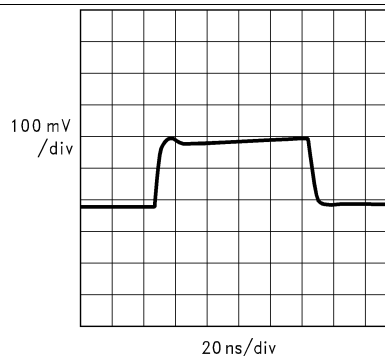

Figure 50. Small Signal Pulse Response,  $A_V = +2$ ,  $V_S = +5\text{ V}$ ,  $R_L = 100\ \Omega$

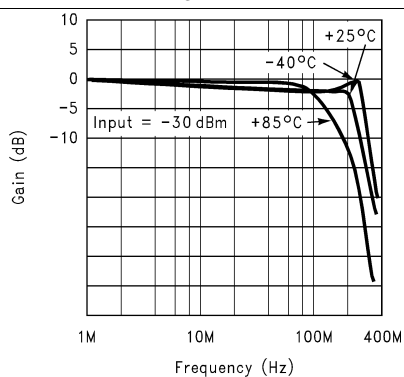

Figure 51. Closed Loop Frequency Response vs. Temperature,  $V_S = \pm 15\text{ V}$ ,  $A_V = +1$ ,  $R_L = 100\ \Omega$

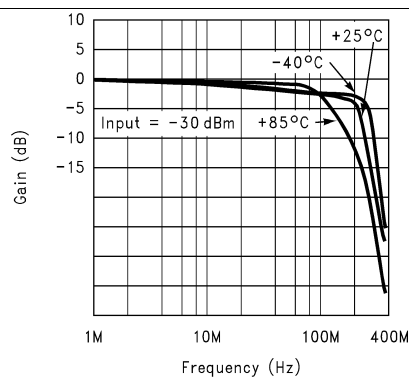

Figure 52. Closed Loop Frequency Response vs. Temperature,  $V_S = \pm 5\text{ V}$ ,  $A_V = +1$ ,  $R_L = 100\ \Omega$

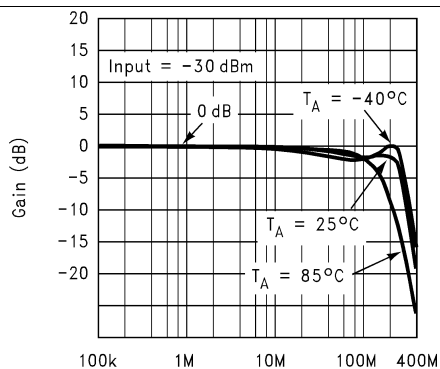

Figure 53. Closed Loop Frequency Response vs. Temperature,  $V_S = +5\text{ V}$ ,  $A_V = +1$ ,  $R_L = 100\ \Omega$

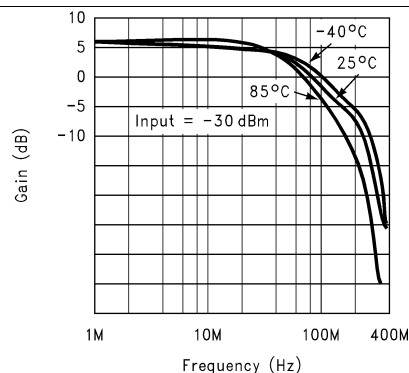
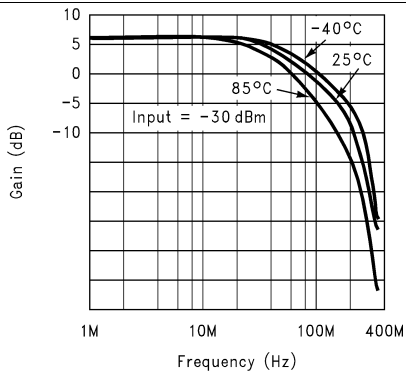
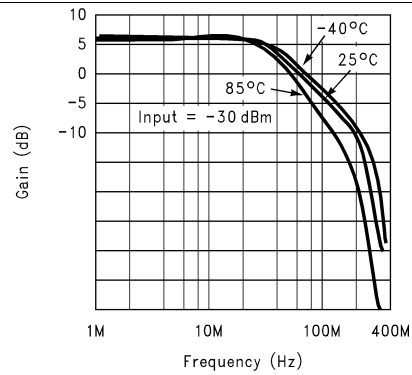

Figure 54. Closed Loop Frequency Response vs. Temperature,  $V_S = \pm 15\text{ V}$ ,  $A_V = +2$ ,  $R_L = 100\ \Omega$

Typical Characteristics (continued)



**Figure 55. Closed Loop Frequency Response vs. Temperature,**  
 $V_S = \pm 5\text{ V}$ ,  $A_V = +2$ ,  $R_L = 100\ \Omega$



**Figure 56. Closed Loop Frequency Response vs. Temperature,**  
 $V_S = +5\text{ V}$ ,  $A_V = +2$ ,  $R_L = 100\ \Omega$

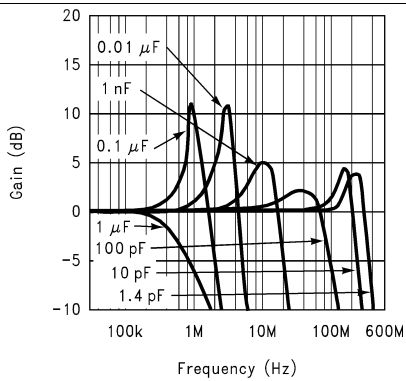

**Figure 57. Closed Loop Frequency Response vs. Capacitance Load**  
 $(A_V = +1, V_S = \pm 15\text{ V})$

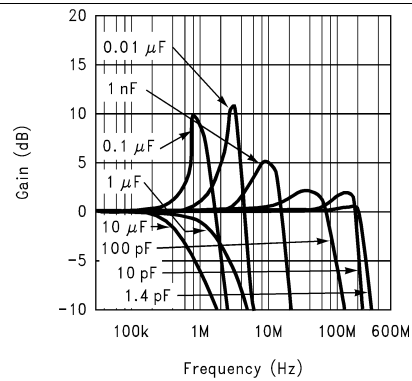

**Figure 58. Closed Loop Frequency Response vs. Capacitive Load**  
 $(A_V = +1, V_S = \pm 5\text{ V})$

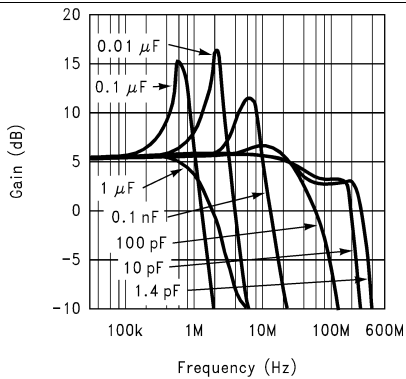

**Figure 59. Closed Loop Frequency Response vs. Capacitive Load**  
 $(A_V = +2, V_S = \pm 15\text{ V})$

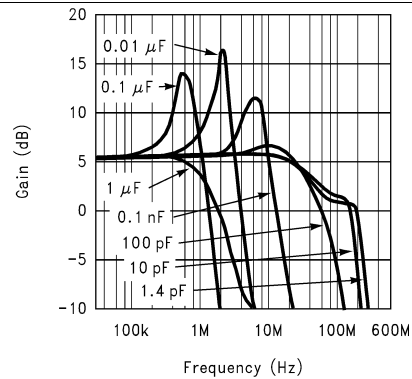

**Figure 60. Closed Loop Frequency Response vs. Capacitive Load**  
 $(A_V = +2, V_S = \pm 5\text{ V})$

Typical Characteristics (continued)

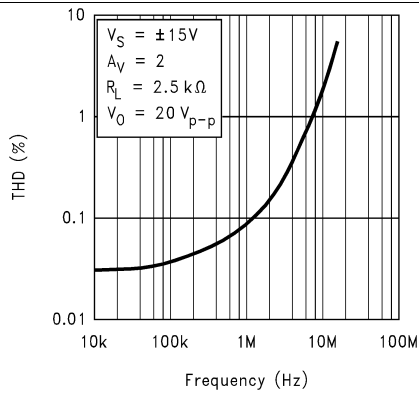

Figure 61. Total Harmonic Distortion vs. Frequency

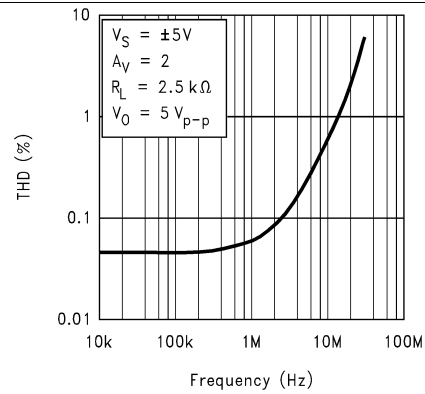

Figure 62. Total Harmonic Distortion vs. Frequency

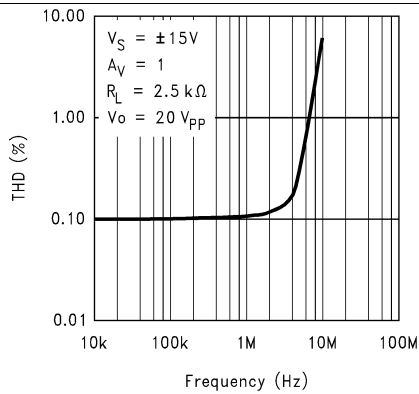

Figure 63. Total Harmonic Distortion vs. Frequency

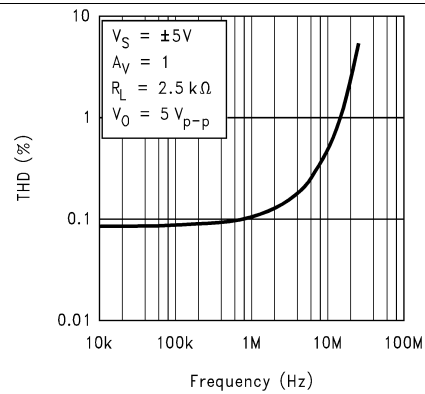

Figure 64. Total Harmonic Distortion vs. Frequency

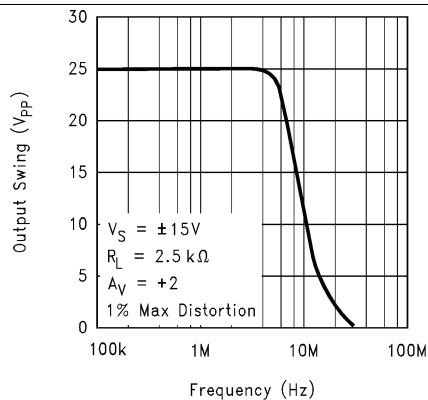

Figure 65. Undistorted Output Swing vs. Frequency

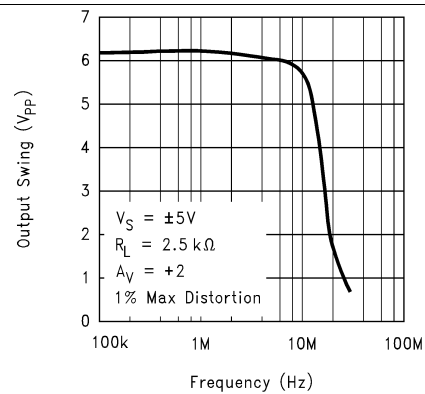
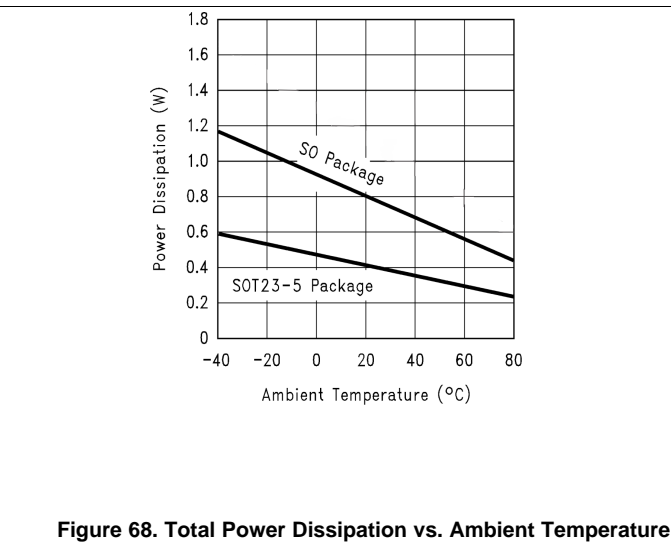
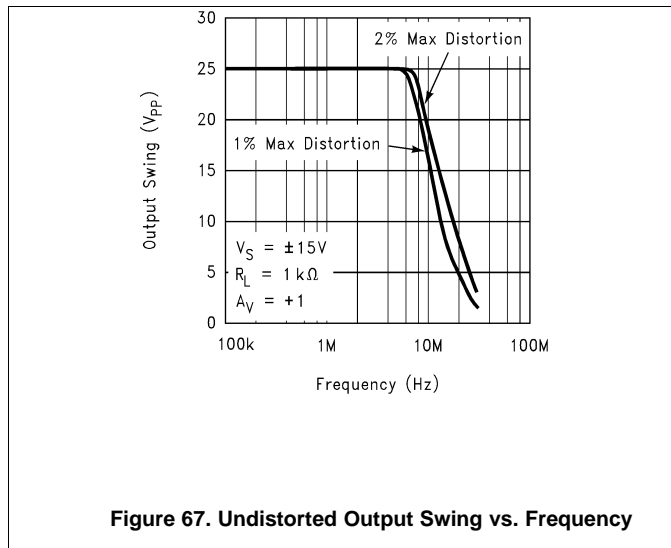

Figure 66. Undistorted Output Swing vs. Frequency

**Typical Characteristics (continued)**



## 7 Application and Implementation

### NOTE

Information in the following applications sections is not part of the TI component specification, and TI does not warrant its accuracy or completeness. TI's customers are responsible for determining suitability of components for their purposes. Customers should validate and test their design implementation to confirm system functionality.

### 7.1 Application Information

Table 1 depicts the maximum operating supply voltage for each package type

**Table 1. Maximum Supply Voltage Values**

	SOT-23	SO-8
Single Supply	10 V	30 V
Dual Supplies	±5 V	±15 V

Stable unity gain operation is possible with supply voltage of 5 V for all capacitive loads. This allows the possibility of using the device in portable applications with low supply voltages with minimum components around it.

Above a supply voltage of 6 V (±3 V Dual supplies), an additional resistor and capacitor (shown in [Figure 69](#)) should be placed in the feedback path to achieve stability at unity gain over the full temperature range.

The package power dissipation should be taken into account when operating at high ambient temperatures and/or high power dissipative conditions. Refer to the power derating curves in the data sheet for each type of package.

In determining maximum operable temperature of the device, make sure the total power dissipation of the device is considered; this includes the power dissipated in the device with a load connected to the output as well as the nominal dissipation of the op amp.

The device is capable of tolerating momentary short circuits from its output to ground but prolonged operation in this mode will damage the device, if the maximum allowed junction temperature is exceeded.

## 7.2 Typical Applications

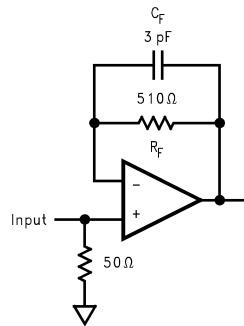

Figure 69. Typical Circuit for  $A_V = +1$  Operation ( $V_S = 6\text{ V}$ )

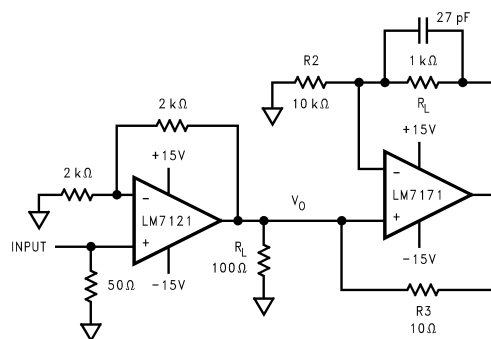

Figure 70. Simple Circuit to Improve Linearity and Output Drive Current

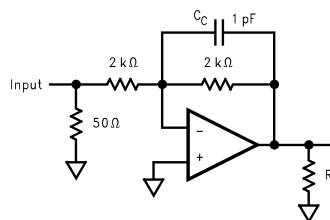
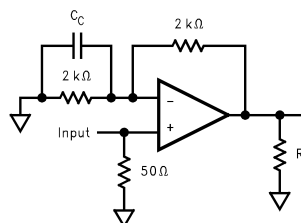

Figure 71.  $A_V = -1$



$C_C = 2\text{ pF}$  for  $R_L = 100\ \Omega$   
 $C_C = \text{Open}$  for  $R_L = \text{Open}$

Figure 72.  $A_V = +2$

## Typical Applications (continued)

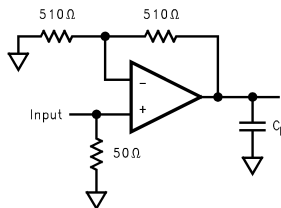
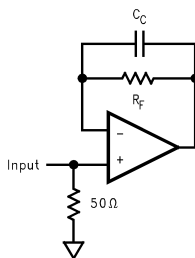
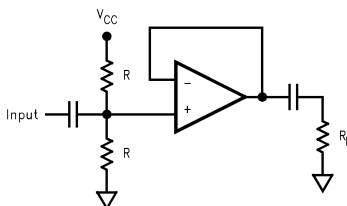

Figure 73.  $A_V = +2$ , Capacitive Load



$R_F = 0 \Omega$ ,  $C_C = \text{Open}$  for  $V_S < 6 \text{ V}$   
 $R_F = 510 \Omega$ ,  $C_C = 3 \text{ pF}$  for  $V_S \geq 6 \text{ V}$

Figure 74.  $A_V = +1$



$R_F = 0 \Omega$ ,  $C_C = \text{Open}$  for  $V_S < 6 \text{ V}$   
 $R_F = 510 \Omega$ ,  $C_C = 3 \text{ pF}$  for  $V_S \geq 6 \text{ V}$

Figure 75.  $A_V = +1$ ,  $V_S = +5 \text{ V}$ , Single Supply Operation

### 7.2.1 Design Requirements

#### 7.2.1.1 Current Boost Circuit

The circuit in [Figure 70](#) can be used to achieve good linearity along with high output current capability.

By proper choice of  $R_3$ , the LM7121 output can be set to supply a minimal amount of current, thereby improving its output linearity.

$R_3$  can be adjusted to allow for different loads:

$$R_3 = 0.1 R_L \quad (1)$$

[Figure 70](#) has been set for a load of  $100 \Omega$ . Reasonable speeds ( $< 30 \text{ ns}$  rise and fall times) can be expected up to  $120 \text{ mA}$  of load current (see [Figure 77](#) for step response across the load).

## Typical Applications (continued)

### 7.2.2 Detailed Design Procedure

It is very important to keep the lead lengths to a minimum and to provide a low impedance current path by using a ground-plane on the board.

#### CAUTION

If  $R_L$  is removed, the current balance at the output of LM7121 would be disturbed and it would have to supply the full amount of load current. This might damage the part if power dissipation limit is exceeded.

#### 7.2.2.1 Color Video on Twisted Pairs Using Single Supply

The circuit shown in Figure 76 can be used to drive in excess of 25 meters length of twisted pair cable with no loss of resolution or picture definition when driving a NTSC monitor at the load end.

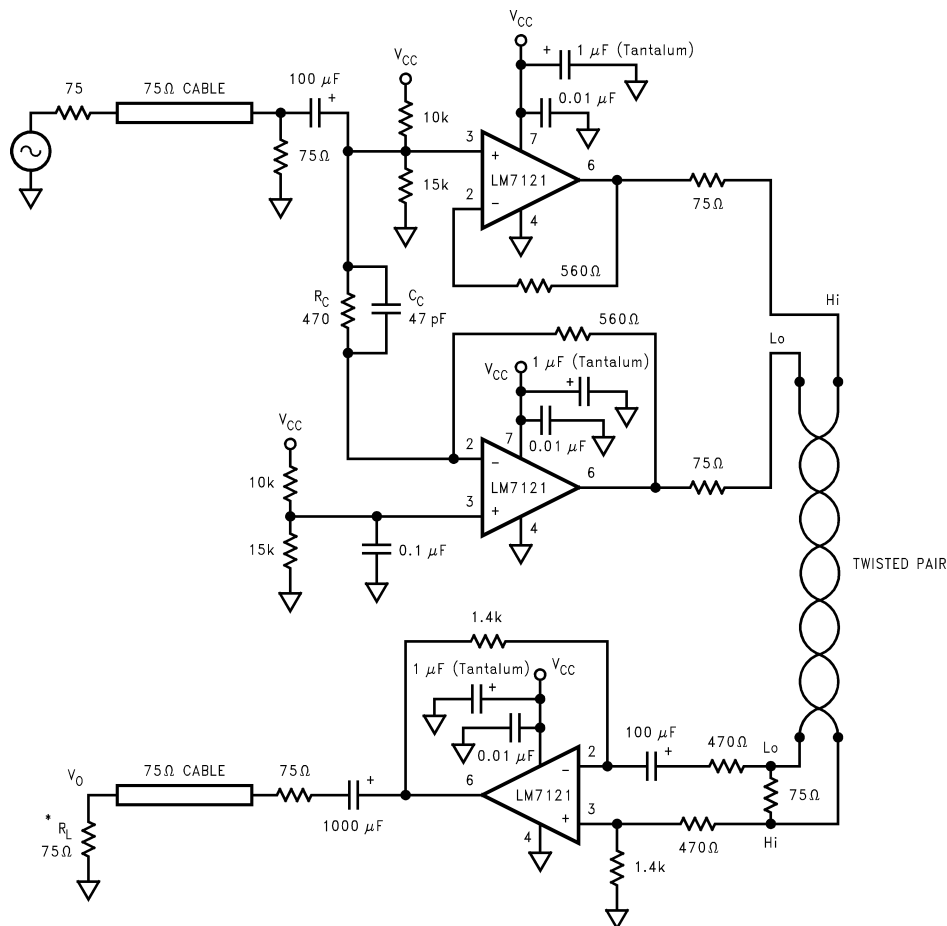

Pin numbers shown are for SO-8 package.

\* Input termination of NTSC monitor.

**Figure 76. Single Supply Differential Twisted Pair Cable Transmitter/Receiver,  $8.5\text{ V} \leq V_{CC} \leq 30\text{ V}$**



### Typical Applications (continued)

Differential Gain and Differential Phase errors measured at the load are less than 1% and 1° respectively

$R_G$  and  $C_C$  can be adjusted for various cable lengths to compensate for the line losses and for proper response at the output. Values shown correspond to a twisted pair cable length of 25 meters with about 3 turns/inch (see [Figure 78](#) for step response).

The supply voltage can vary from 8.5 V up to 30 V with the output rise and fall times under 12 ns. With the component values shown, the overall gain from the input to the output is about 1.

Even though the transmission line is not terminated in its nominal characteristic impedance of about 600  $\Omega$ , the resulting reflection at the load is only about 5% of the total signal and in most cases can be neglected. Using 75 termination instead, has the advantage of operating at a low impedance and results in a higher realizable bandwidth and signal fidelity.

### 7.2.3 Application Performance Plots

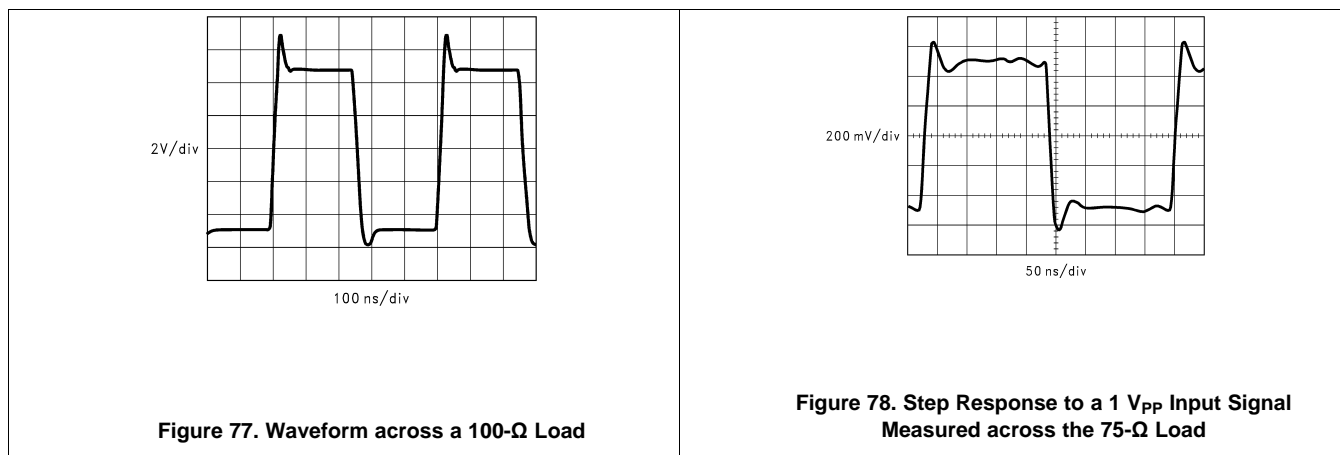

## 8 Device and Documentation Support

### 8.1 Trademarks

All trademarks are the property of their respective owners.

### 8.2 Electrostatic Discharge Caution



These devices have limited built-in ESD protection. The leads should be shorted together or the device placed in conductive foam during storage or handling to prevent electrostatic damage to the MOS gates.

### 8.3 Glossary

[SLYZ022](#) — *TI Glossary*.

This glossary lists and explains terms, acronyms, and definitions.

## 9 Mechanical, Packaging, and Orderable Information

The following pages include mechanical, packaging, and orderable information. This information is the most current data available for the designated devices. This data is subject to change without notice and revision of this document. For browser-based versions of this data sheet, refer to the left-hand navigation.

**PACKAGING INFORMATION**

Orderable Device	Status (1)	Package Type	Package Drawing	Pins	Package Qty	Eco Plan (2)	Lead/Ball Finish (6)	MSL Peak Temp (3)	Op Temp (°C)	Device Marking (4/5)	Samples
LM7121IM	NRND	SOIC	D	8	95	TBD	Call TI	Call TI	-40 to 85	LM71 21IM	
LM7121IM/NOPB	ACTIVE	SOIC	D	8	95	Green (RoHS & no Sb/Br)	SN	Level-1-260C-UNLIM	-40 to 85	LM71 21IM	<a href="#">Samples</a>
LM7121IM5	NRND	SOT-23	DBV	5	1000	TBD	Call TI	Call TI	-40 to 85	A03A	
LM7121IM5/NOPB	ACTIVE	SOT-23	DBV	5	1000	Green (RoHS & no Sb/Br)	SN	Level-1-260C-UNLIM	-40 to 85	A03A	<a href="#">Samples</a>
LM7121IM5X/NOPB	ACTIVE	SOT-23	DBV	5	3000	Green (RoHS & no Sb/Br)	SN	Level-1-260C-UNLIM	-40 to 85	A03A	<a href="#">Samples</a>
LM7121IMX/NOPB	ACTIVE	SOIC	D	8	2500	Green (RoHS & no Sb/Br)	SN	Level-1-260C-UNLIM	-40 to 85	LM71 21IM	<a href="#">Samples</a>

(1) The marketing status values are defined as follows:

**ACTIVE:** Product device recommended for new designs.

**LIFEBUY:** TI has announced that the device will be discontinued, and a lifetime-buy period is in effect.

**NRND:** Not recommended for new designs. Device is in production to support existing customers, but TI does not recommend using this part in a new design.

**PREVIEW:** Device has been announced but is not in production. Samples may or may not be available.

**OBSELETE:** TI has discontinued the production of the device.

(2) **RoHS:** TI defines "RoHS" to mean semiconductor products that are compliant with the current EU RoHS requirements for all 10 RoHS substances, including the requirement that RoHS substance do not exceed 0.1% by weight in homogeneous materials. Where designed to be soldered at high temperatures, "RoHS" products are suitable for use in specified lead-free processes. TI may reference these types of products as "Pb-Free".

**RoHS Exempt:** TI defines "RoHS Exempt" to mean products that contain lead but are compliant with EU RoHS pursuant to a specific EU RoHS exemption.

**Green:** TI defines "Green" to mean the content of Chlorine (Cl) and Bromine (Br) based flame retardants meet JS709B low halogen requirements of <=1000ppm threshold. Antimony trioxide based flame retardants must also meet the <=1000ppm threshold requirement.

(3) MSL, Peak Temp. - The Moisture Sensitivity Level rating according to the JEDEC industry standard classifications, and peak solder temperature.

(4) There may be additional marking, which relates to the logo, the lot trace code information, or the environmental category on the device.

(5) Multiple Device Markings will be inside parentheses. Only one Device Marking contained in parentheses and separated by a "~" will appear on a device. If a line is indented then it is a continuation of the previous line and the two combined represent the entire Device Marking for that device.

(6) Lead/Ball Finish - Orderable Devices may have multiple material finish options. Finish options are separated by a vertical ruled line. Lead/Ball Finish values may wrap to two lines if the finish value exceeds the maximum column width.

**Important Information and Disclaimer:** The information provided on this page represents TI's knowledge and belief as of the date that it is provided. TI bases its knowledge and belief on information provided by third parties, and makes no representation or warranty as to the accuracy of such information. Efforts are underway to better integrate information from third parties. TI has taken and continues to take reasonable steps to provide representative and accurate information but may not have conducted destructive testing or chemical analysis on incoming materials and chemicals. TI and TI suppliers consider certain information to be proprietary, and thus CAS numbers and other limited information may not be available for release.

In no event shall TI's liability arising out of such information exceed the total purchase price of the TI part(s) at issue in this document sold by TI to Customer on an annual basis.

## IMPORTANT NOTICE AND DISCLAIMER

TI PROVIDES TECHNICAL AND RELIABILITY DATA (INCLUDING DATASHEETS), DESIGN RESOURCES (INCLUDING REFERENCE DESIGNS), APPLICATION OR OTHER DESIGN ADVICE, WEB TOOLS, SAFETY INFORMATION, AND OTHER RESOURCES "AS IS" AND WITH ALL FAULTS, AND DISCLAIMS ALL WARRANTIES, EXPRESS AND IMPLIED, INCLUDING WITHOUT LIMITATION ANY IMPLIED WARRANTIES OF MERCHANTABILITY, FITNESS FOR A PARTICULAR PURPOSE OR NON-INFRINGEMENT OF THIRD PARTY INTELLECTUAL PROPERTY RIGHTS.

These resources are intended for skilled developers designing with TI products. You are solely responsible for (1) selecting the appropriate TI products for your application, (2) designing, validating and testing your application, and (3) ensuring your application meets applicable standards, and any other safety, security, or other requirements. These resources are subject to change without notice. TI grants you permission to use these resources only for development of an application that uses the TI products described in the resource. Other reproduction and display of these resources is prohibited. No license is granted to any other TI intellectual property right or to any third party intellectual property right. TI disclaims responsibility for, and you will fully indemnify TI and its representatives against, any claims, damages, costs, losses, and liabilities arising out of your use of these resources.

TI's products are provided subject to TI's Terms of Sale ([www.ti.com/legal/termsofsale.html](http://www.ti.com/legal/termsofsale.html)) or other applicable terms available either on [ti.com](http://ti.com) or provided in conjunction with such TI products. TI's provision of these resources does not expand or otherwise alter TI's applicable warranties or warranty disclaimers for TI products.

Mailing Address: Texas Instruments, Post Office Box 655303, Dallas, Texas 75265  
Copyright © 2020, Texas Instruments Incorporated