

FEATURES

- **Controlled Baseline**
 - One Assembly Site
 - One Test Site
 - One Fabrication Site
- **Extended Temperature Performance of –55°C to 125°C**
- **Enhanced Diminishing Manufacturing Sources (DMS) Support**
- **Enhanced Product-Change Notification**
- **Qualification Pedigree ⁽¹⁾**
- **Designed to Operate at up to 20 Million Data Transfers per Second (Fast-20 SCSI)**
- **Nine Differential Channels for the Data and Control Paths of the Small Computer Systems Interface (SCSI) and Intelligent Peripheral Interface (IPI)**
- **SN75976A Packaged in Thin Shrink Small-Outline Package with 20-Mil Terminal Pitch (DGG)**
- **Two Skew Limits Available**
- **ESD Protection on Bus Terminals Exceeds 12 kV**
- **Low Disabled Supply Current 8 mA Typical**
- **Thermal Shutdown Protection**
- **Positive and Negative Current Limiting**
- **Power-Up/Down Glitch Protection**

(1) Component qualification in accordance with JEDEC and industry standards to ensure reliable operation over an extended temperature range. This includes, but is not limited to, Highly Accelerated Stress Test (HAST) or biased 85/85, temperature cycle, autoclave or unbiased HAST, electromigration, bond intermetallic life, and mold compound life. Such qualification testing should not be viewed as justifying use of this component beyond specified performance and environmental limits.

DGG PACKAGE
(TOP VIEW)

GND	1	56	CDE2
BSR	2	55	CDE1
CRE	3	54	CDE0
1A	4	53	9B+
1DE/RE	5	52	9B–
2A	6	51	8B+
2DE/RE	7	50	8B–
3A	8	49	7B+
3DE/RE	9	48	7B–
4A	10	47	6B+
4DE/RE	11	46	6B–
V _{CC}	12	45	V _{CC}
GND	13	44	GND
GND	14	43	GND
GND	15	42	GND
GND	16	41	GND
GND	17	40	GND
V _{CC}	18	39	V _{CC}
5A	19	38	5B+
5DE/RE	20	37	5B–
6A	21	36	4B+
6DE/RE	22	35	4B–
7A	23	34	3B+
7DE/RE	24	33	3B–
8A	25	32	2B+
8DE/RE	26	31	2B–
9A	27	30	1B+
9DE/RE	28	29	1B–

Terminals 13 through 17 and 40 through 44 are connected together to the package lead frame and signal ground.

DESCRIPTION/ORDERING INFORMATION

The SN75976A is an improved replacement for the industry's first 9-channel 485 transceiver – the SN75LBC976. The A version offers improved switching performance, a smaller package, and higher ESD protection. The SN75976A is offered in two versions. The '976A2 skew limits of 4 ns for the differential drivers and 5 ns for the differential receivers complies with the recommended skew budget of the Fast-20 SCSI standard for data transfer rates up to 20 million transfers per second. The '976A1 supports the Fast SCSI skew budget for 10 million transfers per second. The skew limit ensures that the propagation delay times, not only from channel-to-channel but from device-to-device, are closely matched for the tight skew budgets associated with high-speed parallel data buses.



Please be aware that an important notice concerning availability, standard warranty, and use in critical applications of Texas Instruments semiconductor products and disclaimers thereto appears at the end of this data sheet.

SN75976A-EP 9-CHANNEL DIFFERENTIAL TRANSCEIVER

SLLS878A–JANUARY 2008–REVISED FEBRUARY 2008

DESCRIPTION/ORDERING INFORMATION (CONTINUED)

The patented thermal enhancements made to the 56-pin shrink small-outline package (SSOP) of the SN75976 have been applied to the new, thin shrink, small-outline package (TSSOP). The TSSOP package offers even less board area requirements than the SSOP while reducing the package height to 1 mm. This provides more board area and allows component mounting to both sides of the printed circuit boards for low-profile, space-restricted applications such as small form-factor hard disk drives.

In addition to speed improvements, the '976A can withstand electrostatic discharges exceeding 12 kV using the human-body model, and 600 V using the machine model of MIL-PRF-38535, Method 3015.7 on the RS-485 I/O terminals. This is six times the industry standard and provides protection from the noise that can be coupled into external cables. The other terminals of the device can withstand discharges exceeding 4 kV and 400 V respectively.

Each of the nine channels of the '976A typically meet or exceed the requirements of 485 (1983) and ISO 8482-1987/ TIA TR30.2 referenced by American National Standard of Information (ANSI) Systems, X3.131-1994 (SCSI-2) standard, X2.277-1996 (Fast-20 Parallel Interface), and the Intelligent Peripheral Interface Physical Layer-ANSI X3.129-1986 standard.

The SN75976A is characterized for operation over an ambient air temperature range of -55°C to 125°C .

AVAILABLE OPTIONS⁽¹⁾

T_A	SKEW LIMIT (ns)		PACKAGE ⁽²⁾⁽³⁾
	DRIVER	RECEIVER	TSSOP (DGG)
-55°C to 125°C	8	9	SN75976A1MDGGREP

- (1) For the most current package and ordering information, see the Package Option Addendum at the end of this document, or see the TI website at www.ti.com.
- (2) Package drawings, thermal data, and symbolization are available at www.ti.com/packaging.
- (3) The R suffix indicates taped and reeled packages.

TERMINAL FUNCTIONS

TERMINAL		LOGIC LEVEL	I/O	TERMINATION	DESCRIPTION
NAME	NO.				
1A to 9A	4, 6, 8, 10, 19, 21, 23, 25, 27	TTL	I/O	Pullup	1A to 9A carry data to and from the communication controller.
1B [–] to 9B [–]	29, 31, 33, 35, 37, 46, 48, 50, 52	RS-485	I/O	Pulldown	1B [–] to 9B [–] are the inverted data signals of the balanced pair to/from the bus.
1B ⁺ to 9B ⁺	30, 32, 34, 36, 38, 47, 49, 51, 53	RS-485	I/O	Pullup	1B ⁺ to 9B ⁺ are the noninverted data signals of the balanced pair to/from the bus.
BSR	2	TTL	Input	Pullup	BSR is the bit significant response. BSR disables receivers 1 through 8 and enables wired-OR drivers when BSR and DE/RE and CDE1 or CDE2 are high. Channel 9 is placed in a high-impedance state with BSR high.
CDE0	54	TTL	Input	Pulldown	CDE0 is the common driver enable 0. Its input signal enables all drivers when CDE0 and 1DE/RE – 9DE/RE are high.
CDE1	55	TTL	Input	Pulldown	CDE1 is the common driver enable 1. Its input signal enables drivers 1 to 4 when CDE1 is high and BSR is low.
CDE2	56	TTL	Input	Pulldown	CDE2 is the common driver enable 2. When CDE2 is high and BSR is low, drivers 5 to 8 are enabled.
CRE	3	TTL	Input	Pullup	CRE is the common receiver enable. When high, CRE disables receiver channels 5 to 9.
1DE/RE to 9DE/RE	5, 7, 9, 11, 20, 22, 24, 26, 28	TTL	Input	Pullup	1DE/RE–9DE/RE are direction controls that transmit data to the bus when it and CDE0 are high. Data is received from the bus when 1DE/RE–9DE/RE and CRE and BSR are low and CDE1 and CDE2 are low.
GND	1, 13, 14, 15, 16, 17, 40, 41, 42, 43, 44	NA	Power	NA	GND is the circuit ground. All GND terminals except terminal 1 are physically tied to the die pad for improved thermal conductivity. ⁽¹⁾
V _{CC}	12, 18, 39, 45	NA	Power	NA	Supply voltage

(1) Terminal 1 must be connected to signal ground for proper operation.

SN75976A-EP 9-CHANNEL DIFFERENTIAL TRANSCIEVER

SLLS878A—JANUARY 2008—REVISED FEBRUARY 2008

LOGIC DIAGRAM (POSITIVE LOGIC)

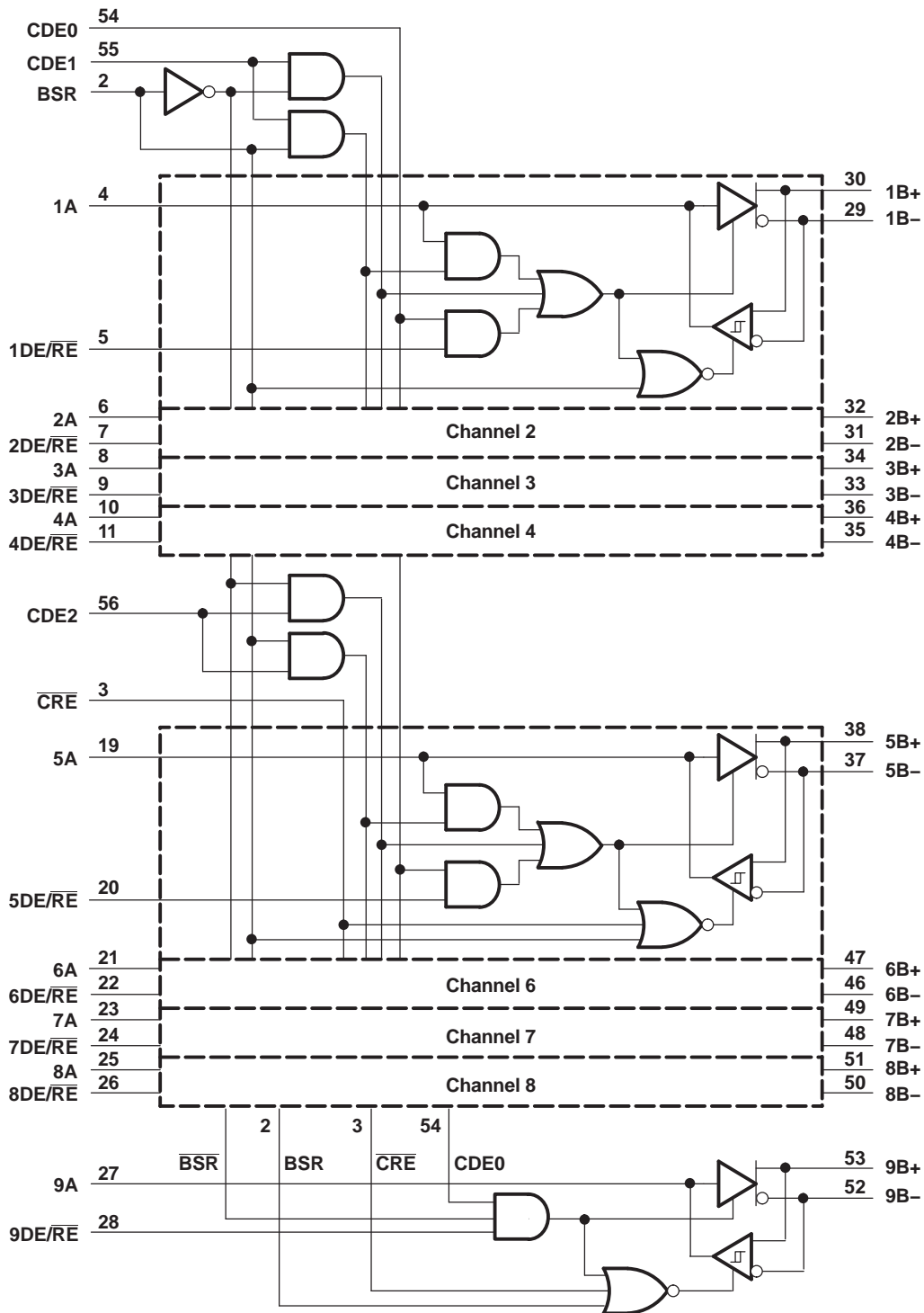

SCHEMATICS OF INPUTS AND OUTPUTS

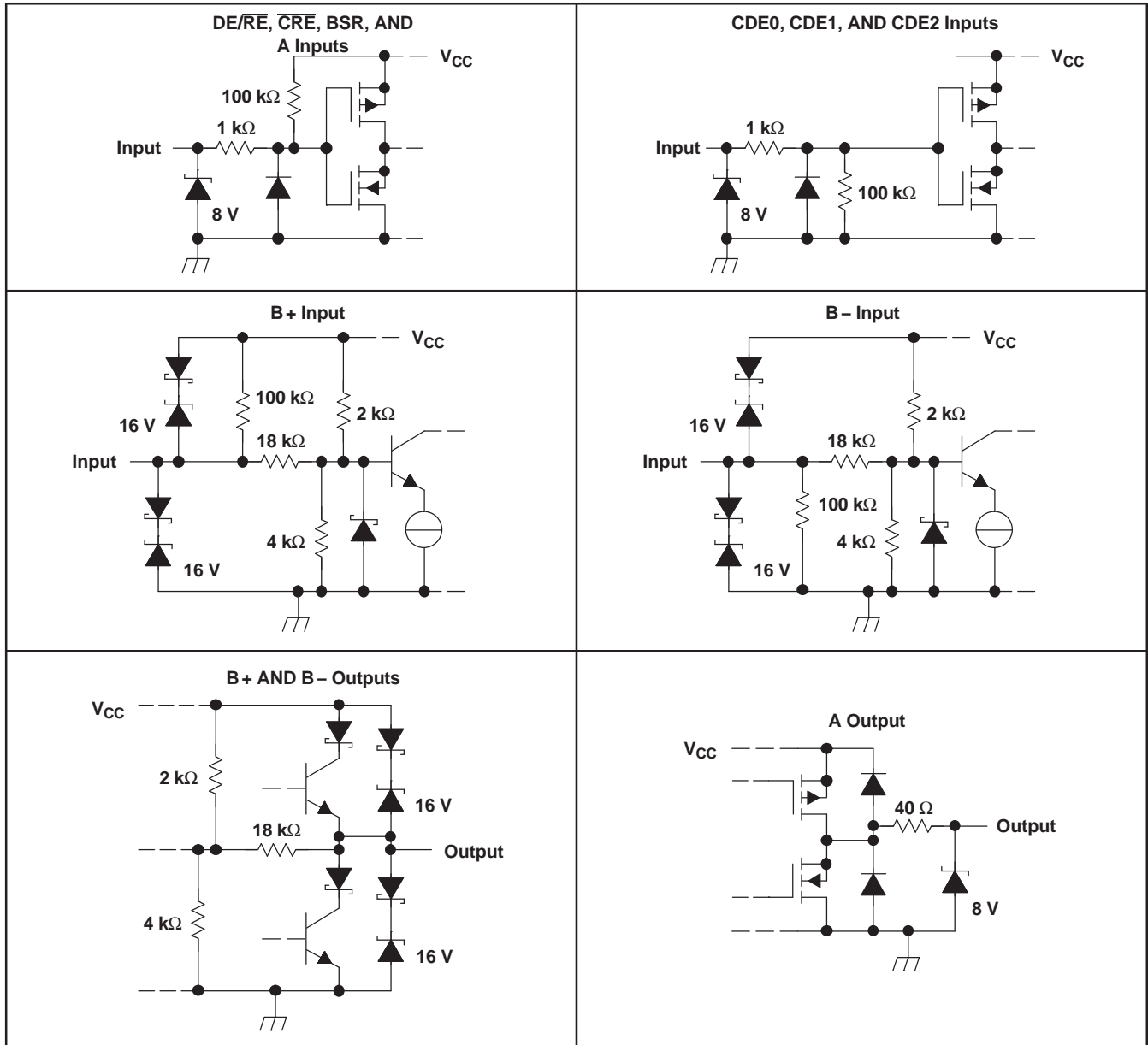

SN75976A-EP 9-CHANNEL DIFFERENTIAL TRANSCIVER

SLLS878A—JANUARY 2008—REVISED FEBRUARY 2008

Absolute Maximum Ratings⁽¹⁾

over operating free-air temperature range (unless otherwise noted)

		MIN	MAX	UNIT
V _{CC}	Supply voltage range ⁽²⁾	-0.3	6	V
	Bus voltage range	-10	15	V
	Data I/O and control (A side) voltage range	-0.3	V _{CC} + 0.5	V
I _O	Receiver output current		±40	mA
Electrostatic discharge	B side and GND, Class 3, A: ⁽³⁾		12	kV
	B side and GND, Class 3, B: ⁽³⁾		400	V
	All terminals, Class 3, A:		4	kV
	All terminals, Class 3, B:		400	V
T _{stg}	Storage temperature	-65	150	°C
Continuous total power dissipation ⁽⁴⁾		Internally Limited		

- (1) Stresses beyond those listed under "absolute maximum ratings" may cause permanent damage to the device. These are stress ratings only, and functional operation of the device at these or any other conditions beyond those indicated under "recommended operating conditions" is not implied. Exposure to absolute-maximum-rated conditions for extended periods may affect device reliability.
- (2) All voltage values are with respect to the GND terminals.
- (3) This absolute maximum rating is tested in accordance with MIL-STD-883, Method 3015.7.
- (4) The maximum operating junction temperature is internally limited. Use the Dissipation Rating Table to operate below this temperature.

Dissipation Ratings

PACKAGE	T _A ≤ 25°C	OPERATING FACTOR ⁽¹⁾ ABOVE T _A = 25°C	T _A = 70°C POWER RATING	T _A = 125°C POWER RATING
DGG	2500 mW	20 mW/°C	1600 mW	—

- (1) This is the inverse of the junction-to-ambient thermal resistance when board-mounted and with no air flow.

Package Thermal Characteristics

PARAMETER		TEST CONDITIONS	MIN	TYP	MAX	UNIT
R _{qθJA}	Junction-to-ambient thermal resistance	DGG, board-mounted, no air flow		50		°C/W
R _{θJC}	Junction-to-case thermal resistance	DGG		27		°C/W
T _{JS}	Thermal-shutdown junction temperature			165		°C

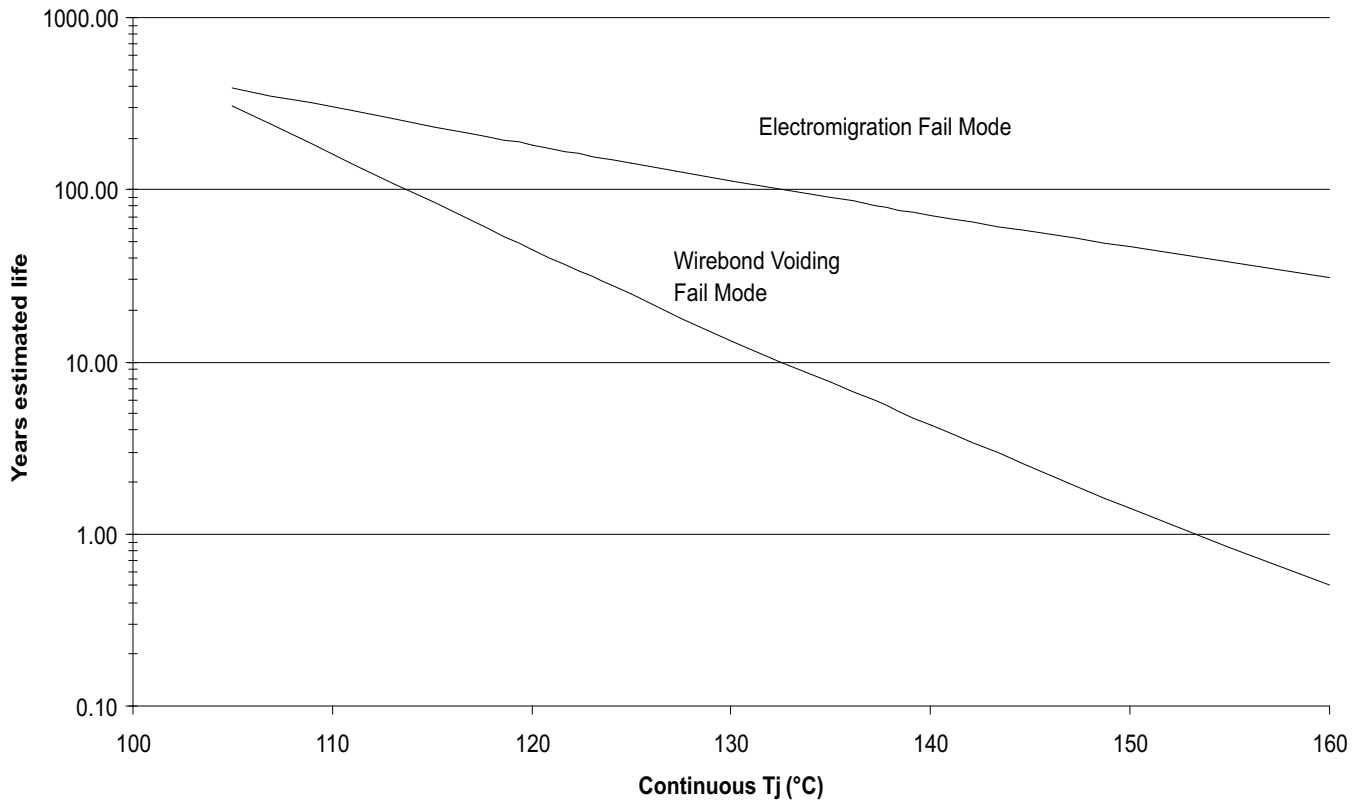

- A. See Datasheet for Absolute Maximum and Minimum Recommended Operating Conditions.
- B. Silicon Operating life Design Goal is 10 years @105°C Junction Temperature (does not include package interconnect life).
- C. Enhanced Plastic Product Disclaimer Applies.
- D. Long-term high-temperature storage and/or extended use at maximum recommended operating conditions may result in a reduction of overall device life. See Chart for additional information on thermal derating. Electromigration failure mode applies to powered part, Kirkendall voiding failure mode is a function of temperature only.

Figure 1. SN75976A-EP Operating Life Derating Chart

Recommended Operating Conditions

		MIN	NOM	MAX	UNIT	
V _{CC}	Supply voltage	4.75	5	5.25	V	
V _{IH}	High-level input voltage	Except nB+, nB ⁻⁽¹⁾		2	V	
V _{IL}	Low-level input voltage	Except nB+, nB ⁻⁽¹⁾		0.8	V	
V _O , V _I , or V _{IC}	Voltage at any bus terminal (separately or common-mode)	nB+ or nB-		12 -7	V	
I _{OH}	High-level output current	Driver		-60	mA	
		Receiver		-8		
I _{OL}	Low-level output current	Driver		60	mA	
		Receiver		8		
T _A	Operating free-air temperature	SN75976A		-55	125	°C

(1) n = 1 – 9

Electrical Characteristics

over recommended operating free-air temperature range (unless otherwise noted)

PARAMETER		TEST CONDITIONS			MIN	TYP ⁽¹⁾	MAX	UNIT
V _{ODH}	Driver differential high-level output voltage	S1 to A,	V _T = 5 V,	See Figure 2	0.7			V
		S1 to B, See Figure 1		V _T = 5 V,	0.7			
V _{ODL}	Driver differential low-level output voltage	S1 to A, T _C ≥ 25°C		V _T = 5 V, See Figure 2	0.7	-1.4		V
		S1 to B,	V _T = 5 V,	See Figure 2	0.7	-1.8		
		S1 to A, See Figure 1		V _T = 5 V,	-0.8	-1.4		
V _{OH}	High-level output voltage	A side, I _{OH} = -8 mA		V _{ID} = 200 mV, See Figure 4	4	4.5		V
		B side,	V _T = 5 V,	See Figure 2		3		
V _{OL}	Low-level output voltage	A side, I _{OH} = 8 mA		V _{ID} = -200 mV, See Figure 4		0.6	0.8	V
		A side,	V _T = 5 V,	See Figure 2		1		
V _{IT+}	Receiver positive-going differential input threshold voltage	I _{OH} = -8 mA,		See Figure 4			0.2	V
V _{IT-}	Receiver negative-going differential input threshold voltage	I _{OL} = 8 mA,		See Figure 4			-0.2	V
V _{hys}	Receiver input hysteresis (V _{IT+} - V _{IT-})	V _{CC} = 5 V,		T _A = 25°C	24	45		mV
I _I	Bus input current	V _{IH} = 12 V,	V _{CC} = 5 V,	Other input at 0 V		0.4	1	mA
		V _{IH} = 12 V,	V _{CC} = 0,	Other input at 0 V		0.5	1	
		V _{IH} = -7 V,	V _{CC} = 5 V,	Other input at 0 V		-0.4	-0.8	
		V _{IH} = -7 V,	V _{CC} = 0,	Other input at 0 V		-0.3	-0.8	
I _{IH}	High-level input current	A, BSR, DE/ \overline{RE} , and \overline{CRE} ,		V _{IH} = 2 V			-100	μA
		CDE0, CDE1, and CDE2,		V _{IH} = 2V			100	
I _{IL}	Low-level input current	A, BSR, DE/ \overline{RE} , and \overline{CRE} ,		V _{IL} = 0.8 V			-100	μA
		CDE1, CDE1, and CDE2,		V _{IL} = 0.8 V			100	
I _{OS}	Short circuit output current	nB+ or nB-					±260	mA
I _{OZ}	High-impedance-state output current	A			See I _{IH} and I _{IL}			
		nB+ or nB-			See I _I			
I _{CC}	Supply current	Disabled					10	mA
		All drivers enabled, no load					60	
		All receivers enabled, no load					45	
C _O	Output capacitance	nB+ or nB- to GND				18		pF
C _{pd}	Power dissipation capacitance ⁽²⁾	Receiver				40		pF
		Driver				100		

(1) All typical values are at V_{CC} = 5 V, T_A = 25°C.

(2) C_{pd} determines the no-load dynamic supply current consumption, I_S = C_{PD} × V_{CC} × f + I_{CC}.

Driver Switching Characteristics

over recommended operating conditions (unless otherwise noted)

PARAMETER		TEST CONDITIONS			MIN	TYP ⁽¹⁾	MAX	UNIT
t _{pd}	Propagation delay time, t _{PHL} or t _{PLH} (see Figures 2 and 3)	'976A1	V _{CC} = 5 V,	T _A = 25°C			15	ns
t _{sk(lim)}	Skew limit, maximum t _{pd} - minimum t _{pd} ⁽²⁾	'976A1					8	ns
t _{sk(p)}	Pulse skew, t _{PHL} - t _{PLH}						4	ns

(1) All typical values are at V_{CC} = 5 V, T_A = 25°C.

(2) This parameter is applicable at one V_{CC} and operating temperature within the recommended operating conditions and to any two devices.

Driver Switching Characteristics (continued)

over recommended operating conditions (unless otherwise noted)

PARAMETER		TEST CONDITIONS	MIN	TYP ⁽¹⁾	MAX	UNIT
t_f	Fall time	S1 to B, See Figure 3		4		ns
t_r	Rise time	See Figure 3		8		ns
t_{en}	Enable time, control inputs to active output				60	ns
t_{dis}	Disable time, control inputs to high-impedance output				140	ns
t_{PHZ}	Propagation delay time, high-level to high-impedance output	See Figures 6 and 7			120	ns
t_{PLZ}	Propagation delay time, low-level to high-impedance output				120	ns
t_{PZH}	Propagation delay time, high-impedance to high-level output				60	ns
t_{PZL}	Propagation delay time, high-impedance to low-level output				60	ns

Receiver Switching Characteristics

over recommended operating conditions (unless otherwise noted)

PARAMETER		TEST CONDITIONS	MIN	TYP ⁽¹⁾	MAX	UNIT
t_{pd}	Propagation delay time, t_{PHL} or t_{PLH} (see Figures 4 and 5)	'976A1 $V_{CC} = 5\text{ V}$, $T_A = 25^\circ\text{C}$			19	ns
$t_{sk(lim)}$	Skew limit, maximum t_{pd} – minimum t_{pd} ⁽²⁾	'976A1			9	ns
$t_{sk(p)}$	Pulse skew, $ t_{PHL} - t_{PLH} $			0.6	4	ns
t_t	Transition time (t_r or t_f)	See Figure 5		2		ns
t_{en}	Enable time, control inputs to active output				70	ns
t_{dis}	Disable time, control inputs to high-impedance output				80	ns
t_{PHZ}	Propagation delay time, high-level to high-impedance output	See Figures 8 and 9			80	ns
t_{PLZ}	Propagation delay time, low-level to high-impedance output				70	ns
t_{PZH}	Propagation delay time, high-impedance to high-level output				70	ns
t_{PZL}	Propagation delay time, high-impedance to low-level output				70	ns

 (1) All typical values are at $V_{CC} = 5\text{ V}$, $T_A = 25^\circ\text{C}$.

 (2) This parameter is applicable at one V_{CC} and operating temperature within the recommended operating conditions and to any two devices.

PARAMETER MEASUREMENT INFORMATION

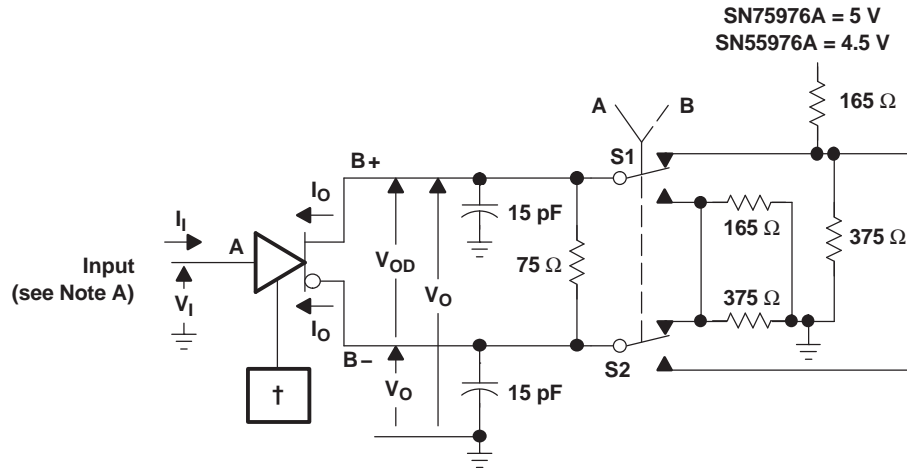

† CDE0 and DE/RE are at 2 V, BSR is at 0.8 V and, for the SN75976A only, all others are open.
‡ For the SN75976A only, all nine drivers are enabled, similarly loaded, and switching.

- A. All input pulses are supplied by a generator having the following characteristics: $t_r \leq 6$ ns, $t_f \leq 6$ ns, PRR ≤ 1 MHz, duty cycle = 50%, $Z_O = 50 \Omega$.
- B. All resistances are in Ω and $\pm 5\%$, unless otherwise indicated.
- C. All capacitances are in pF and $\pm 10\%$, unless otherwise indicated.
- D. All indicated voltages are ± 10 mV.

Figure 2. Driver Test Circuit, Currents, and Voltages

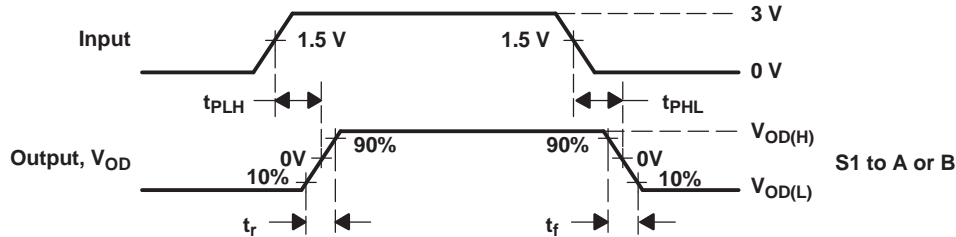

- A. All input pulses are supplied by a generator having the following characteristics: $t_r \leq 6$ ns, $t_f \leq 6$ ns, PRR ≤ 1 MHz, duty cycle = 50%, $Z_O = 50 \Omega$.
- B. All resistances are in Ω and $\pm 5\%$, unless otherwise indicated.
- C. All capacitances are in pF and $\pm 10\%$, unless otherwise indicated.
- D. All indicated voltages are ± 10 mV.

Figure 3. Driver Delay and Transition Time Test Waveforms

PARAMETER MEASUREMENT INFORMATION (continued)

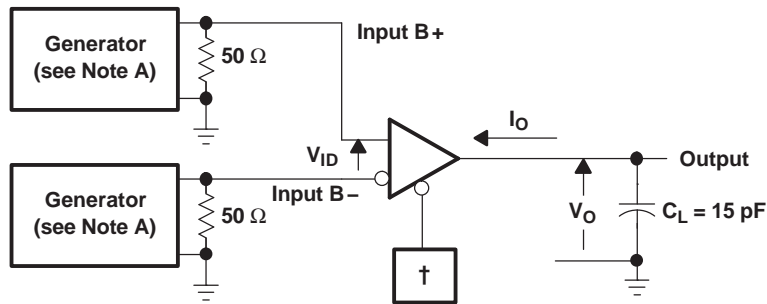

† CDE0, CDE1, CDE2, BSR, CRE, and DE/ \overline{RE} at 0.8 V
‡ For the SN75976A only, all nine receivers are enabled and switching.

- A. All input pulses are supplied by a generator having the following characteristics: $t_r \leq 6$ ns, $t_f \leq 6$ ns, PRR ≤ 1 MHz, duty cycle = 50%, $Z_O = 50 \Omega$.
- B. All resistances are in Ω and $\pm 5\%$, unless otherwise indicated.
- C. All capacitances are in pF and $\pm 10\%$, unless otherwise indicated.
- D. All indicated voltages are ± 10 mV.

Figure 4. Receiver Propagation Delay and Transition Time Test Circuit

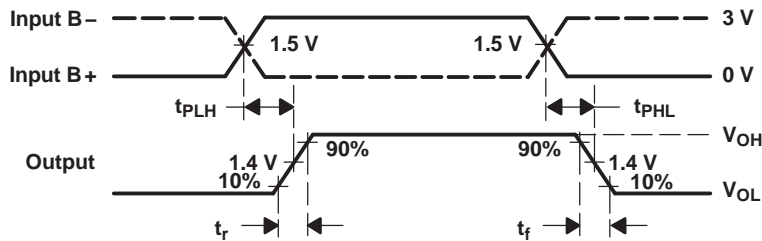

- A. All input pulses are supplied by a generator having the following characteristics: $t_r \leq 6$ ns, $t_f \leq 6$ ns, PRR ≤ 1 MHz, duty cycle = 50%, $Z_O = 50 \Omega$.
- B. All resistances are in Ω and $\pm 5\%$, unless otherwise indicated.
- C. All capacitances are in pF and $\pm 10\%$, unless otherwise indicated.
- D. All indicated voltages are ± 10 mV.

Figure 5. Receiver Delay and Transition Time Waveforms

PARAMETER MEASUREMENT INFORMATION (continued)

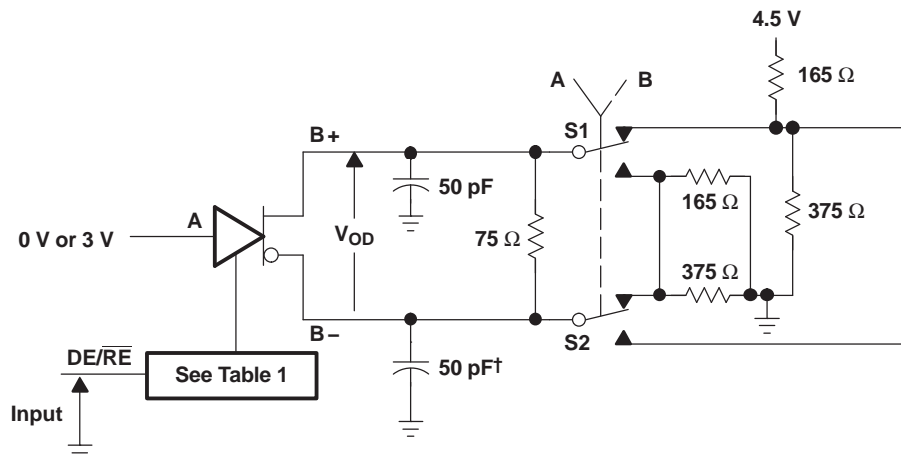

† Includes probe and jig capacitance in two places.

- A. All input pulses are supplied by a generator having the following characteristics: $t_r \leq 6$ ns, $t_f \leq 6$ ns, PRR ≤ 1 MHz, duty cycle = 50%, $Z_O = 50 \Omega$.
- B. All resistances are in Ω and $\pm 5\%$, unless otherwise indicated.
- C. All capacitances are in pF and $\pm 10\%$, unless otherwise indicated.
- D. All indicated voltages are ± 10 mV.

Figure 6. Driver Enable and Disable Time Test Circuit

Table 1. Enabling For Driver Enable and Disable Time

DRIVER	BSR	CDE0	CDE1	CDE2	CRE
1 – 8	H	H	L	L	X
9	L	H	H	H	H

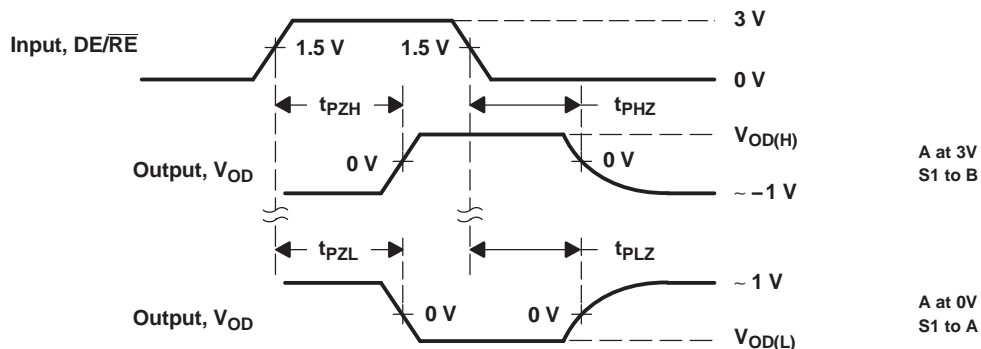

- A. All input pulses are supplied by a generator having the following characteristics: $t_r \leq 6$ ns, $t_f \leq 6$ ns, PRR ≤ 1 MHz, duty cycle = 50%, $Z_O = 50 \Omega$.
- B. All resistances are in Ω and $\pm 5\%$, unless otherwise indicated.
- C. All capacitances are in pF and $\pm 10\%$, unless otherwise indicated.
- D. All indicated voltages are ± 10 mV.

Figure 7. Driver Enable Time Waveforms

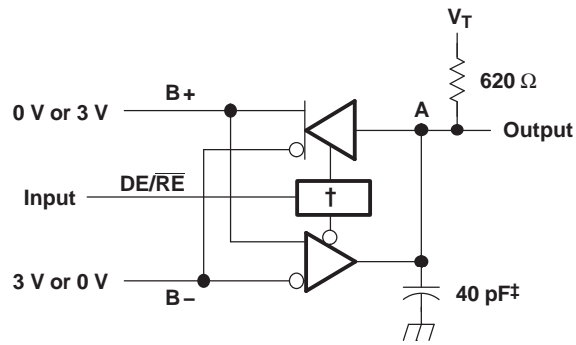

† CDE0 is high, CDE1, CDE2, BSR, and $\overline{\text{CRE}}$ are low and, for the SN75976A only, all others are open.

‡ Includes probe and jig capacitance.

- A. All input pulses are supplied by a generator having the following characteristics: $t_r \leq 6$ ns, $t_f \leq 6$ ns, PRR ≤ 1 MHz, duty cycle = 50%, $Z_O = 50 \Omega$.
- B. All resistances are in Ω and $\pm 5\%$, unless otherwise indicated.
- C. All capacitances are in pF and $\pm 10\%$, unless otherwise indicated.
- D. All indicated voltages are ± 10 mV.

Figure 8. Receiver Enable and Disable Time Test Circuit

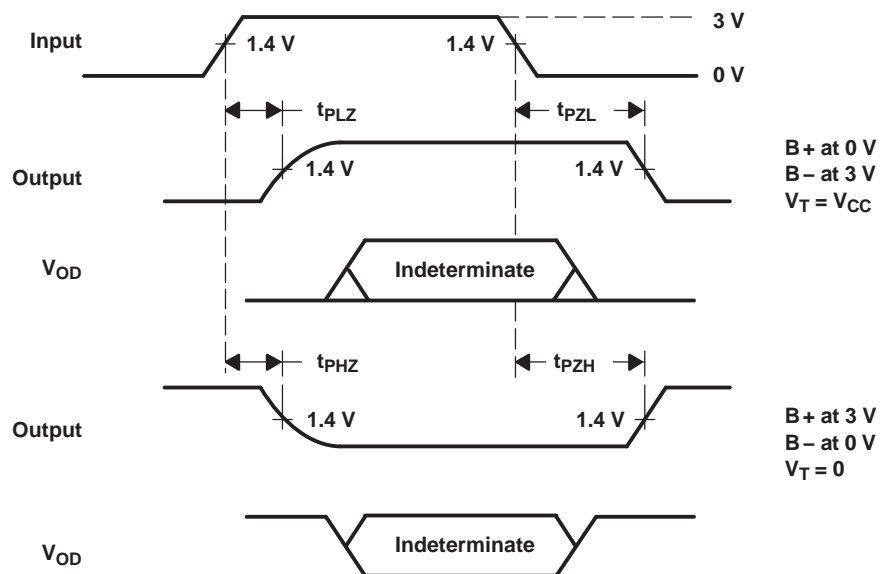

- A. All input pulses are supplied by a generator having the following characteristics: $t_r \leq 6$ ns, $t_f \leq 6$ ns, PRR ≤ 1 MHz, duty cycle = 50%, $Z_O = 50 \Omega$.
- B. All resistances are in Ω and $\pm 5\%$, unless otherwise indicated.
- C. All capacitances are in pF and $\pm 10\%$, unless otherwise indicated.
- D. All indicated voltages are ± 10 mV.

Figure 9. Receiver Enable and Disable Time Waveforms

TYPICAL CHARACTERISTICS

**AVERAGE SUPPLY CURRENT
 VS
 FREQUENCY**

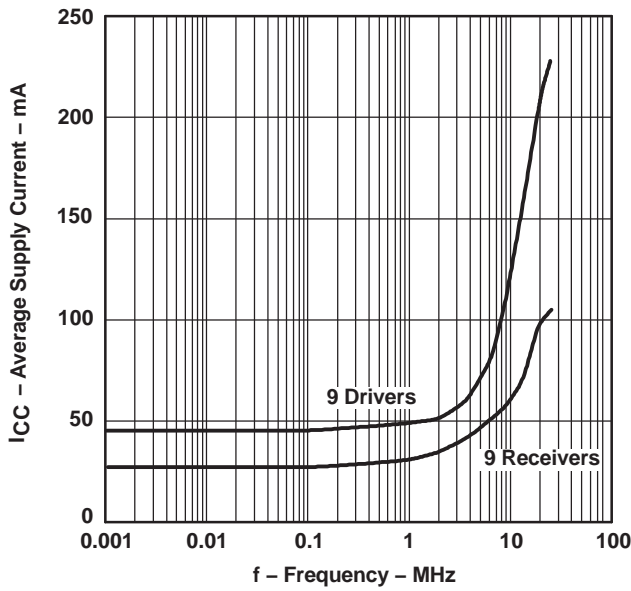

Figure 10.

**LOGIC INPUT CURRENT
 VS
 INPUT VOLTAGE**

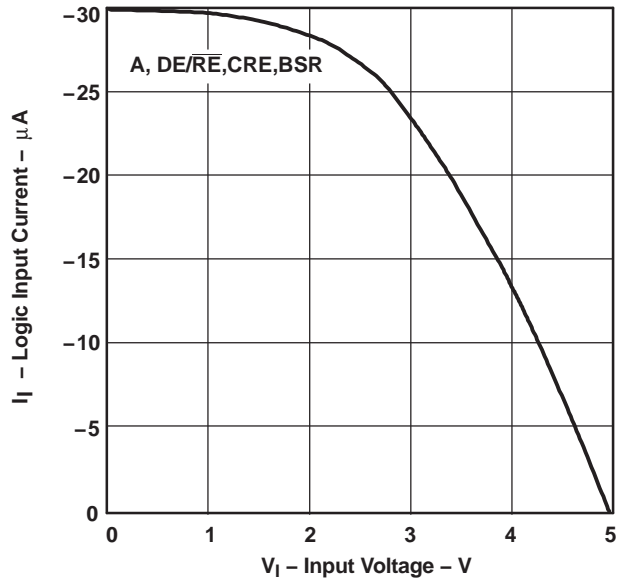

Figure 11.

**BUS
 INPUT CURRENT
 VS
 INPUT VOLTAGE**

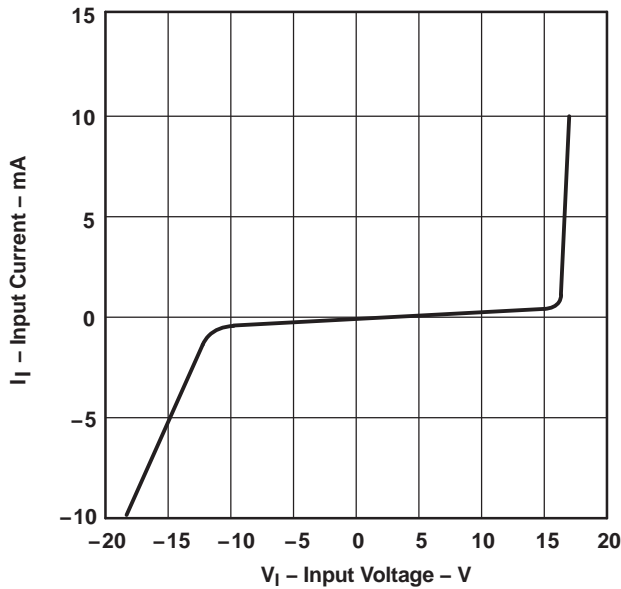

Figure 12.

**DRIVER
 LOW-LEVEL OUTPUT VOLTAGE
 VS
 LOW-LEVEL OUTPUT CURRENT**

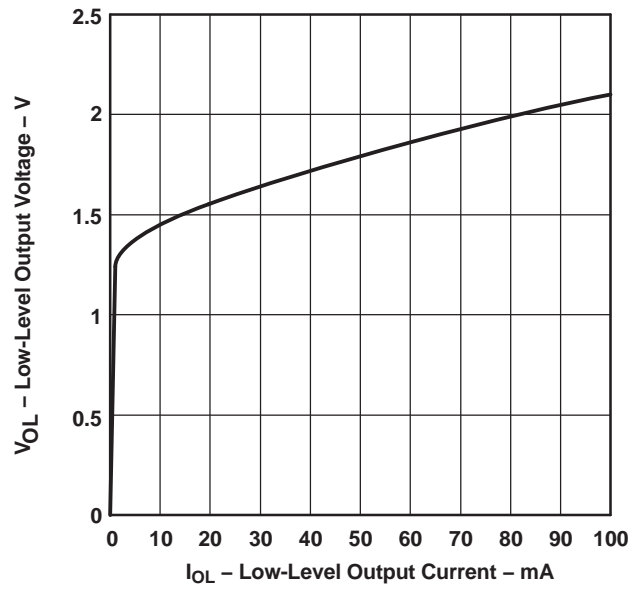
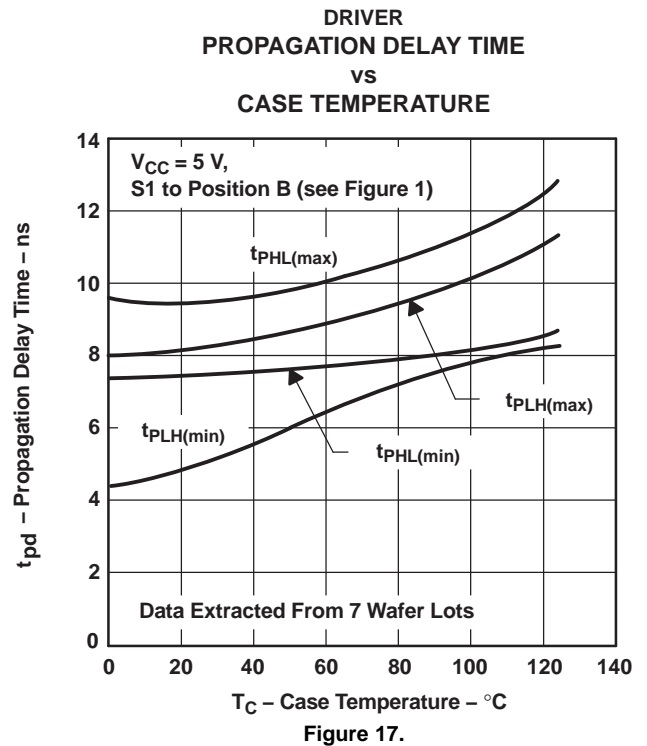
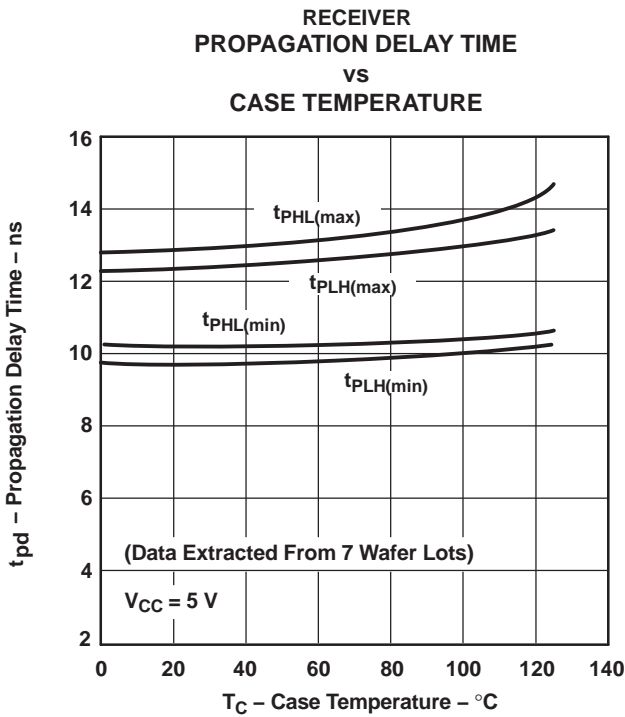
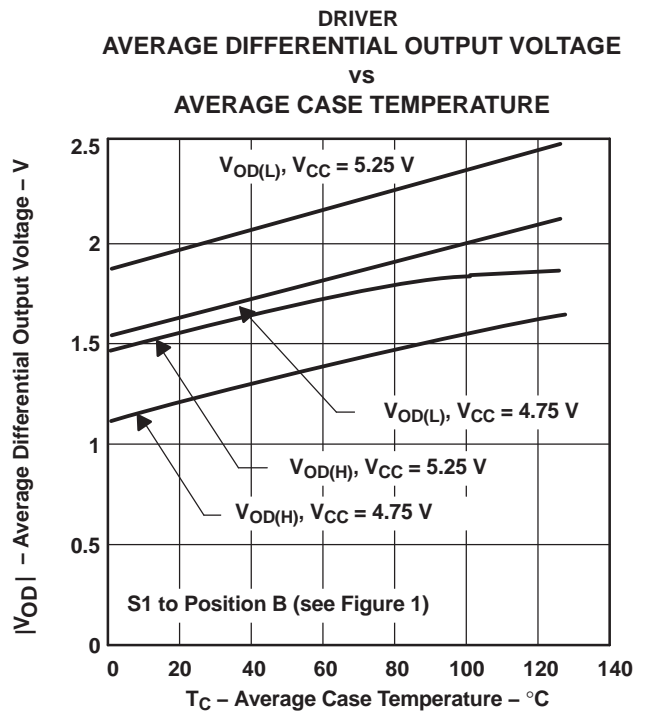
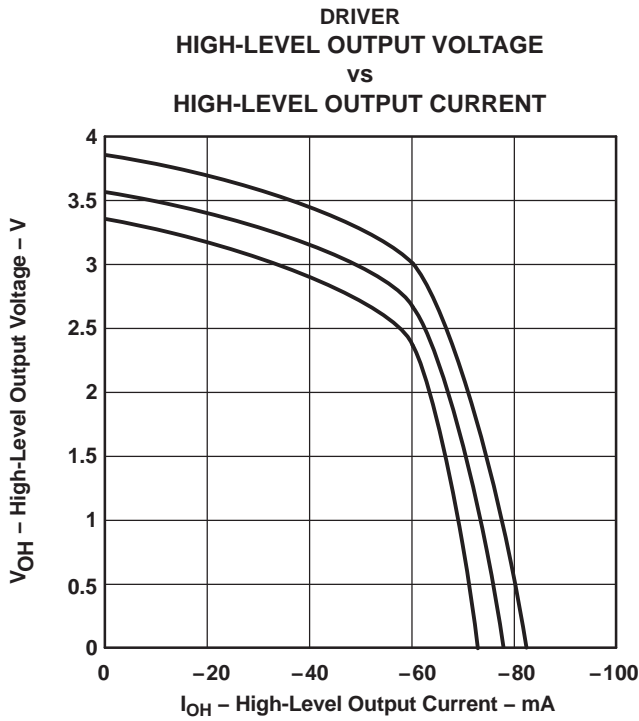

Figure 13.

TYPICAL CHARACTERISTICS (continued)



TYPICAL CHARACTERISTICS (continued)

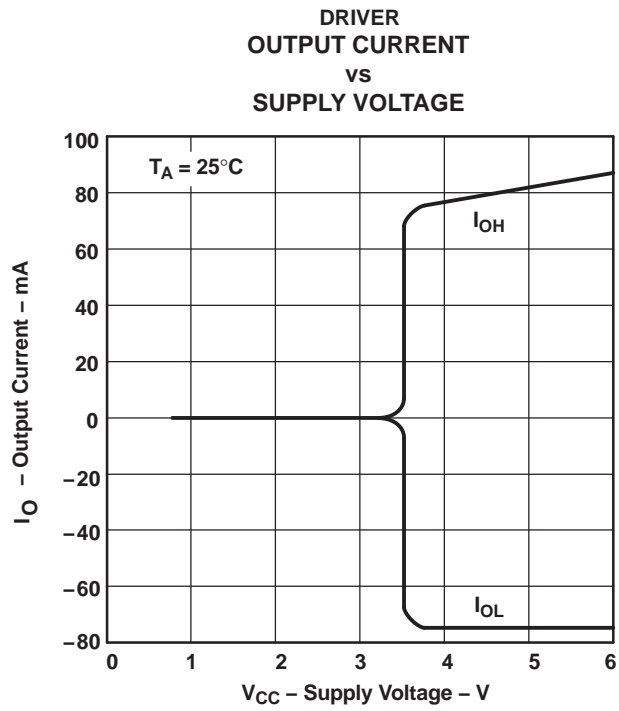

Figure 18.

APPLICATION INFORMATION
Table 2. Typical Signal and Terminal Assignments⁽¹⁾⁽²⁾

SIGNAL	TERMINAL	SCSI DATA	SCSI CONTROL	IPI DATA	IPI CONTROL
CDE0	54	DIFFSENSE	DIFFSENSE	V _{CC}	V _{CC}
CDE1	55	GND	GND	XMTA, XMTB	GND
CDE2	56	GND	GND	XMTA, XMTB	SLAVE/MASTER
BSR	2	GND	GND	GND, BSR	GND
$\overline{\text{CRE}}$	3	GND	GND	GND	V _{CC}
1A	4	DB0, DB8	ATN	AD7, BD7	NOT USED
1DE/ $\overline{\text{RE}}$	5	DBE0, DBE8	INIT EN	GND	GND
2A	6	DB1, DB9	BSY	AD6, BD6	NOT USED
2DE/ $\overline{\text{RE}}$	7	DBE1, DBE9	BSY EN	GND	GND
3A	8	DB2, DB10	ACK	AD5, BD5	SYNC IN
3DE/ $\overline{\text{RE}}$	9	DBE2, DBE10	INIT EN	GND	GND
4A	10	DB3, DB11	RST	AD4, BD4	SLAVE IN
4DE/ $\overline{\text{RE}}$	11	DBE3, DBE11	GND	GND	GND
5A	19	DB4, DB12	MSG	AD3, BD3	NOT USED
5DE/ $\overline{\text{RE}}$	20	DBE4, DBE12	TARG EN	GND	GND
6A	21	DB5, DB13	SEL	AD2, BD2	SYNC OUT
6DE/ $\overline{\text{RE}}$	22	DBE5, DBE13	SEL EN	GND	GND
7A	23	DB6, DB14	C/D	AD1, BD1	MASTER OUT
7DE/ $\overline{\text{RE}}$	24	DBE6, DBE14	TARG EN	GND	GND
8A	25	DB7, DB15	REQ	AD0, BD0	SELECT OUT
8DE/ $\overline{\text{RE}}$	26	DBE7, DBE15	TARG EN	GND	GND
9A	27	DBP0, DBP1	I/O	AP, BP	ATTENTION IN
9DE/ $\overline{\text{RE}}$	28	DBPE0, DBPE1	TARG EN	XMTA, XMTB	V _{CC}

(1) ABBREVIATIONS:

 DB_n = data bit n, where n = (0, 1, . . . , 15)

 DBE_n = data bit n enable, where n = (0, 1, . . . , 15)

DBP0 = parity bit for data bits 0 through 7 or IPI bus A

DBPE0 = parity bit enable for P0

DBP1 = parity bit for data bits 8 through 15 or IPI bus B

DBPE1 = parity bit enable for P1

 AD_n or BD_n = IPI Bus A – Bit n (AD_n) or Bus B – Bit n (BD_n), where n = (0, 1, . . . , 7)

AP or BP = IPI parity bit for bus A or bus B

XMTA or XMTB = transmit enable for IPI bus A or B

BSR = bit significant response

INIT EN = common enable for SCSI initiator mode

TARG EN = common enable for SCSI target mode

(2) Signal inputs are shown as active high. When only active-low inputs are available, logic inversion is accomplished by reversing the B+ and B– connector terminal assignments.

Function Tables

RECEIVER

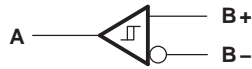

INPUTS		OUTPUT A
B+(B)	B-(B)	
L	H	L
H	L	H

DRIVER



INPUT A	OUTPUTS	
	B+	B-
L	L	H
H	H	L

TRANSCIEVER

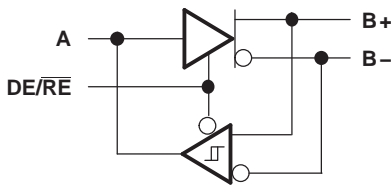

INPUTS				OUTPUTS		
DE/RE	A	B+(B)	B-(B)	A	B+	B-
L	-	L	H	L	-	-
L	-	H	L	H	-	-
H	L	-	-	-	L	H
H	H	-	-	-	H	L

DRIVER WITH ENABLE

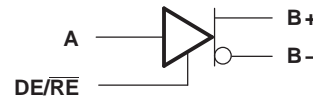

INPUTS		OUTPUTS	
DE/RE	A	B+	B-
L	L	Z	Z
L	H	Z	Z
H	L	L	H
H	H	H	L

WIRED-OR DRIVER

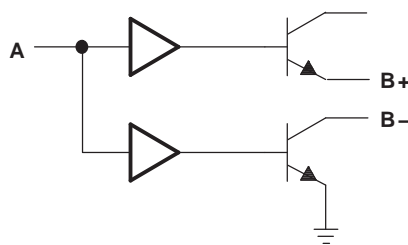

INPUT A	OUTPUTS	
	B+	B-
L	Z	Z
H	H	L

TWO-ENABLE INPUT DRIVER

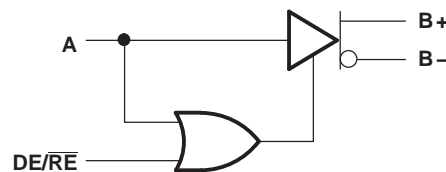

INPUTS		OUTPUTS	
DE/RE	A	B+	B-
L	L	Z	Z
L	H	H	L
H	L	L	H
H	H	H	L

- A. H = high level, L = low level, X = irrelevant, Z = high impedance (off)
 B. An H in this column represents a voltage of 200 mV or higher than the other bus input. An L represents a voltage of 200 mV or lower than the other bus input. Any voltage less than 200 mV results in an indeterminate receiver output.

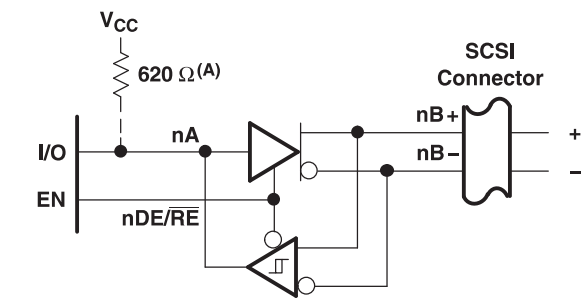

(a) ACTIVE-HIGH BIDIRECTIONAL I/O WITH SEPARATE ENABLE

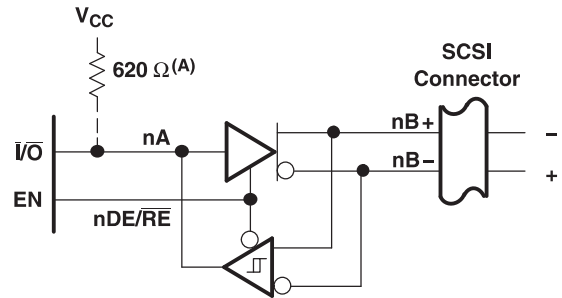

(b) ACTIVE-LOW BIDIRECTIONAL I/O WITH SEPARATE ENABLE

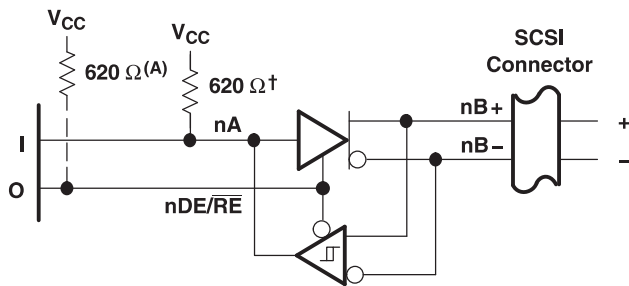

(c) WIRED-OR DRIVER AND ACTIVE-HIGH INPUT

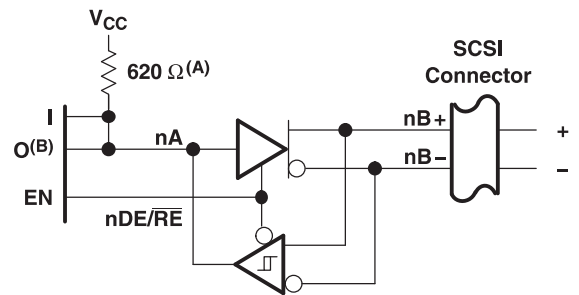

(d) SEPARATE ACTIVE-HIGH INPUT, OUTPUT, AND ENABLE

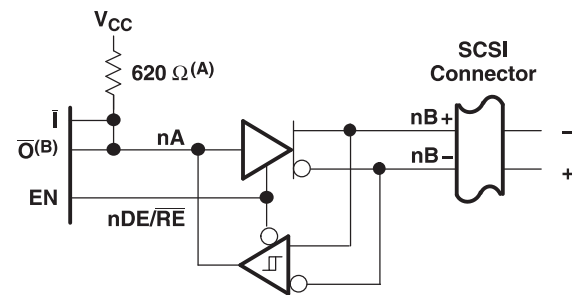

(e) SEPARATE ACTIVE-LOW INPUT AND OUTPUT AND ACTIVE-HIGH ENABLE

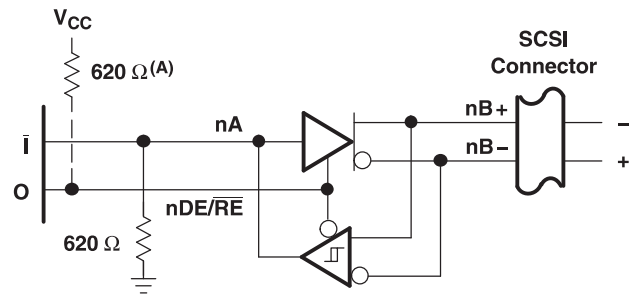

(f) WIRED-OR DRIVER AND ACTIVE-LOW INPUT

- A. When 0 is open drain
- B. Must be open-drain or 3-state output
- C. The BSR, $\overline{\text{CRE}}$, A, and $\text{DE}/\overline{\text{RE}}$ inputs have internal pullup resistors. CDE0, CDE1, and CDE2 have internal pulldown resistors.

Figure 19. Typical SCSI Transceiver Connections

Channel Logic Configurations With Control Input Logic

The following logic diagrams show the positive-logic representation for all combinations of control inputs. The control inputs are from MSB to LSB; the BSR, CDE0, CDE1, CDE2, and C_{RE} bit values are shown below the diagrams. Channel 1 is at the top of the logic diagrams; channel 9 is at the bottom of the logic diagrams.

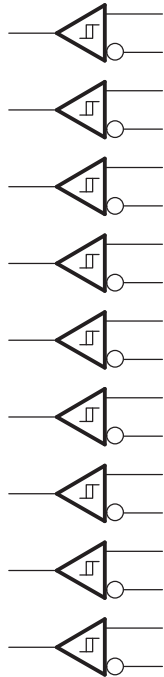

Figure 20. 00000

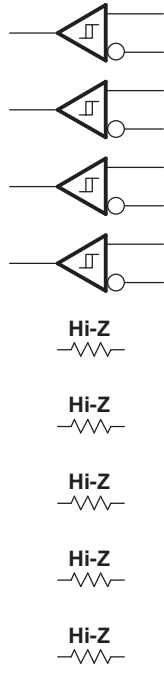

Figure 21. 00001

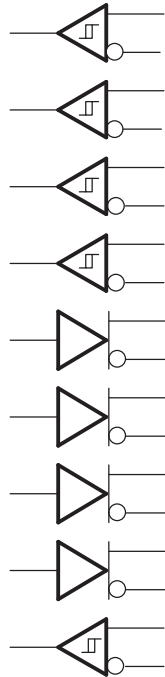

Figure 22. 00010

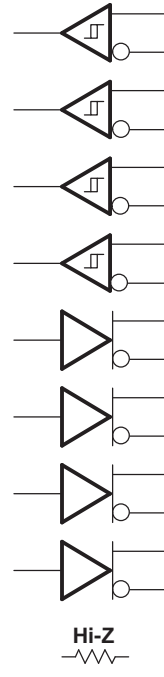

Figure 23. 00011

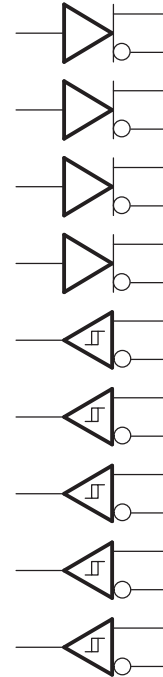

Figure 24. 00100

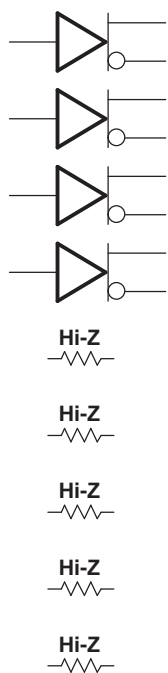

Figure 25. 00101

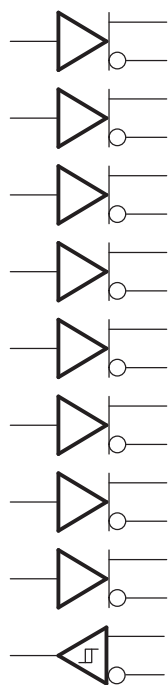

Figure 26. 00110

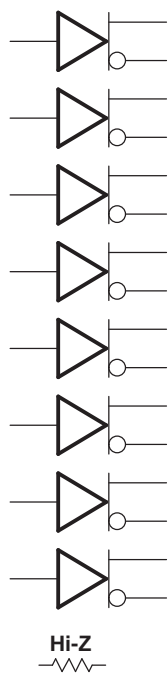

Figure 27. 00111

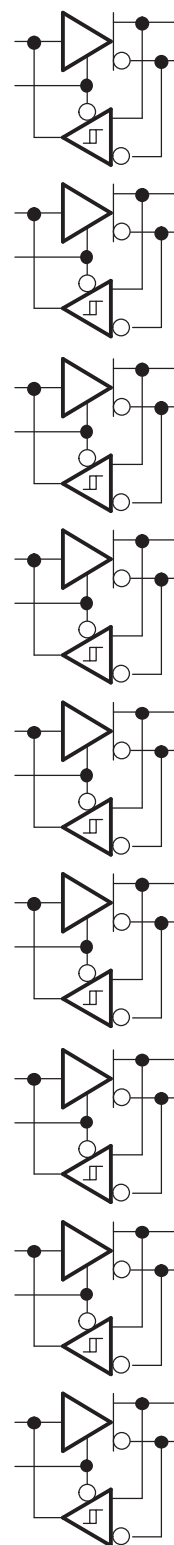

Figure 28. 01000

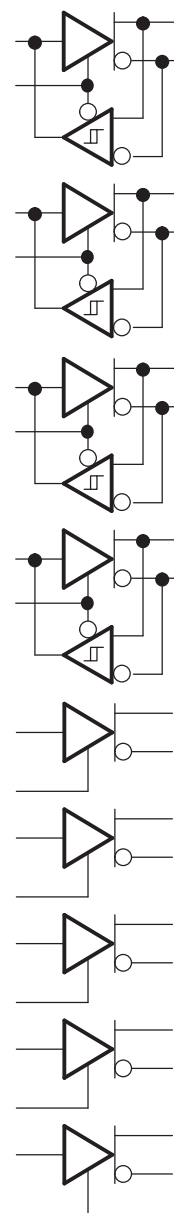

Figure 29. 01001

SN75976A-EP
9-CHANNEL DIFFERENTIAL TRANSCIEVER

SLLS878A—JANUARY 2008—REVISED FEBRUARY 2008

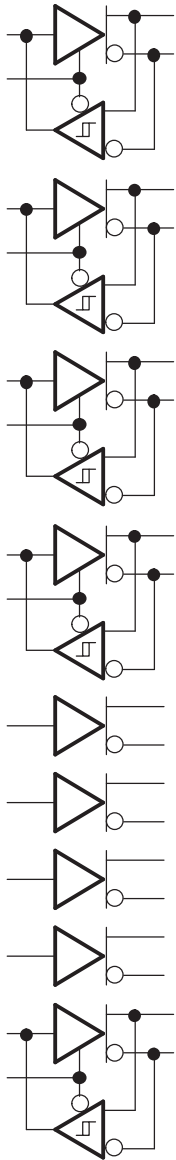

Figure 30. 01010

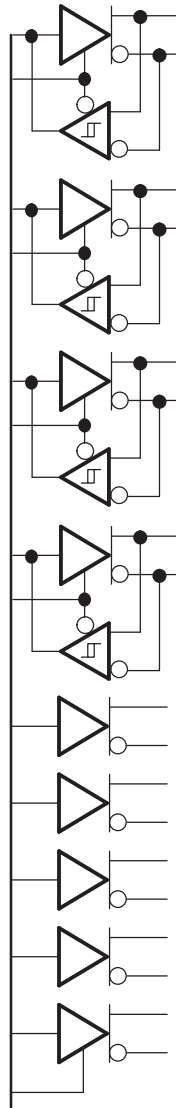

Figure 31. 01011

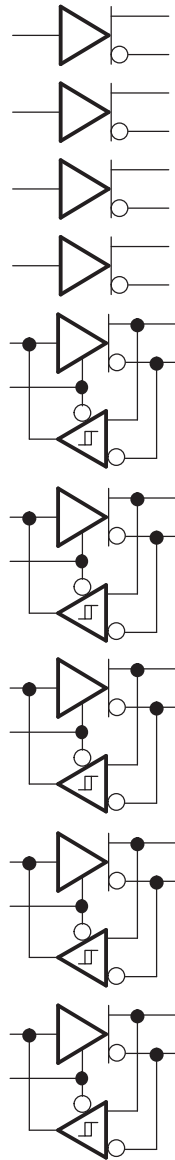

Figure 32. 01100

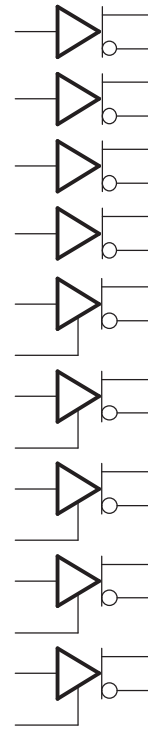

Figure 33. 01101

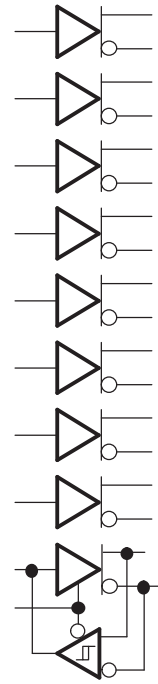

Figure 34. 01110

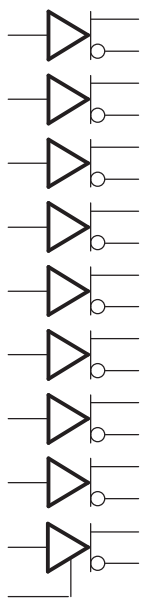

Figure 35. 01111



Figure 36. 10000 and 10001

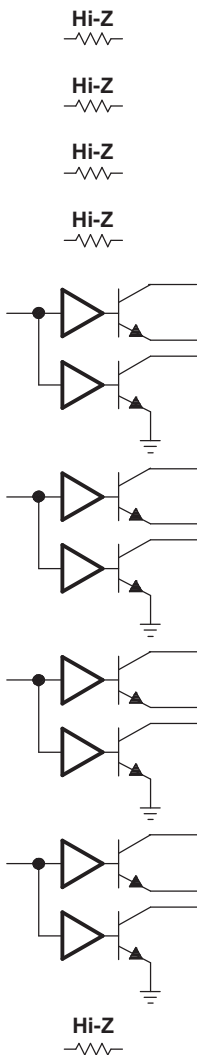

Figure 37. 10010 and 10011

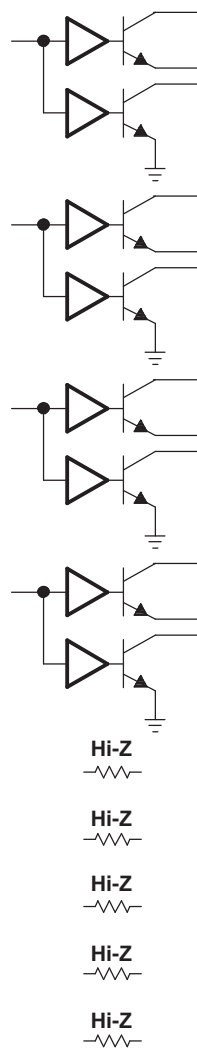

Figure 38. 10100 and 10101

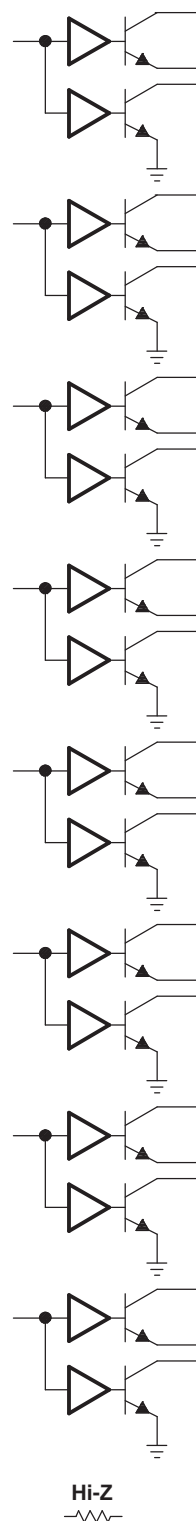

Figure 39. 10110 and 10111

SN75976A-EP
9-CHANNEL DIFFERENTIAL TRANSCIEVER

SLLS878A—JANUARY 2008—REVISED FEBRUARY 2008

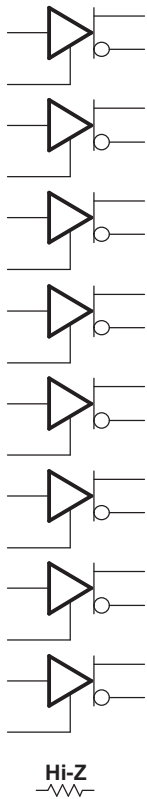

Figure 40. 11000 and 11001

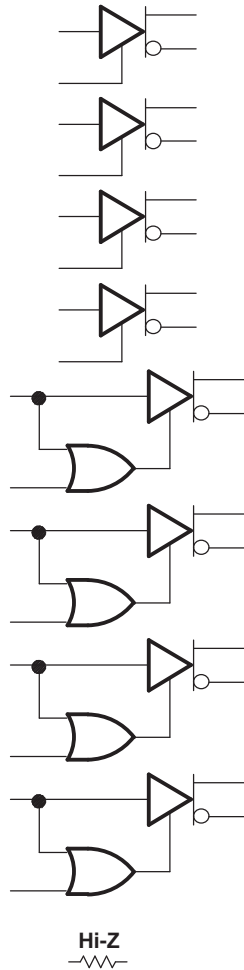

Figure 41. 11010 and 11011

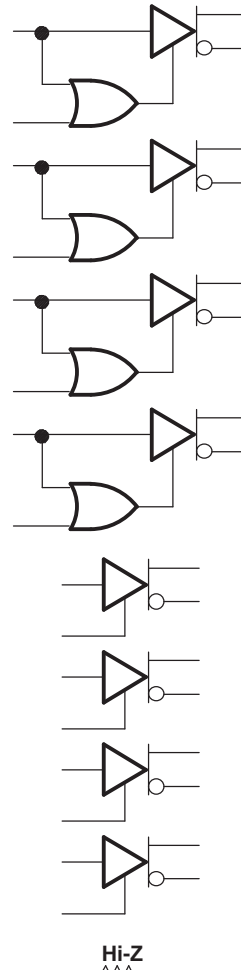

Figure 42. 11100 and 11101

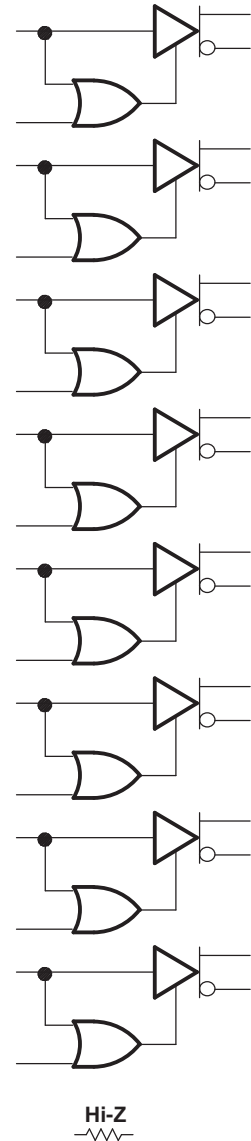

Figure 43. 11110 and 11111

PACKAGING INFORMATION

Orderable Device	Status ⁽¹⁾	Package Type	Package Drawing	Pins	Package Qty	Eco Plan ⁽²⁾	Lead/Ball Finish	MSL Peak Temp ⁽³⁾
SN75976A1MDGGREP	ACTIVE	TSSOP	DGG	56	2000	Green (RoHS & no Sb/Br)	CU NIPDAU	Level-2-260C-1 YEAR
V62/08614-01XE	ACTIVE	TSSOP	DGG	56	2000	Green (RoHS & no Sb/Br)	CU NIPDAU	Level-2-260C-1 YEAR

⁽¹⁾ The marketing status values are defined as follows:

ACTIVE: Product device recommended for new designs.

LIFEBUY: TI has announced that the device will be discontinued, and a lifetime-buy period is in effect.

NRND: Not recommended for new designs. Device is in production to support existing customers, but TI does not recommend using this part in a new design.

PREVIEW: Device has been announced but is not in production. Samples may or may not be available.

OBsolete: TI has discontinued the production of the device.

⁽²⁾ Eco Plan - The planned eco-friendly classification: Pb-Free (RoHS), Pb-Free (RoHS Exempt), or Green (RoHS & no Sb/Br) - please check <http://www.ti.com/productcontent> for the latest availability information and additional product content details.

TBD: The Pb-Free/Green conversion plan has not been defined.

Pb-Free (RoHS): TI's terms "Lead-Free" or "Pb-Free" mean semiconductor products that are compatible with the current RoHS requirements for all 6 substances, including the requirement that lead not exceed 0.1% by weight in homogeneous materials. Where designed to be soldered at high temperatures, TI Pb-Free products are suitable for use in specified lead-free processes.

Pb-Free (RoHS Exempt): This component has a RoHS exemption for either 1) lead-based flip-chip solder bumps used between the die and package, or 2) lead-based die adhesive used between the die and leadframe. The component is otherwise considered Pb-Free (RoHS compatible) as defined above.

Green (RoHS & no Sb/Br): TI defines "Green" to mean Pb-Free (RoHS compatible), and free of Bromine (Br) and Antimony (Sb) based flame retardants (Br or Sb do not exceed 0.1% by weight in homogeneous material)

⁽³⁾ MSL, Peak Temp. -- The Moisture Sensitivity Level rating according to the JEDEC industry standard classifications, and peak solder temperature.

Important Information and Disclaimer:The information provided on this page represents TI's knowledge and belief as of the date that it is provided. TI bases its knowledge and belief on information provided by third parties, and makes no representation or warranty as to the accuracy of such information. Efforts are underway to better integrate information from third parties. TI has taken and continues to take reasonable steps to provide representative and accurate information but may not have conducted destructive testing or chemical analysis on incoming materials and chemicals. TI and TI suppliers consider certain information to be proprietary, and thus CAS numbers and other limited information may not be available for release.

In no event shall TI's liability arising out of such information exceed the total purchase price of the TI part(s) at issue in this document sold by TI to Customer on an annual basis.

OTHER QUALIFIED VERSIONS OF SN75976A-EP :

- Catalog: [SN75976A](#)
- Military: [SN55976A](#)

NOTE: Qualified Version Definitions:

- Catalog - TI's standard catalog product
- Military - QML certified for Military and Defense Applications

TAPE AND REEL INFORMATION



QUADRANT ASSIGNMENTS FOR PIN 1 ORIENTATION IN TAPE

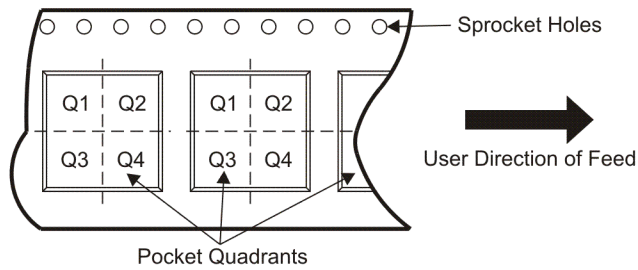

*All dimensions are nominal

Device	Package Type	Package Drawing	Pins	SPQ	Reel Diameter (mm)	Reel Width W1 (mm)	A0 (mm)	B0 (mm)	K0 (mm)	P1 (mm)	W (mm)	Pin1 Quadrant
SN75976A1MDGGREP	TSSOP	DGG	56	2000	330.0	24.4	8.6	15.6	1.8	12.0	24.0	Q1

TAPE AND REEL BOX DIMENSIONS



*All dimensions are nominal

Device	Package Type	Package Drawing	Pins	SPQ	Length (mm)	Width (mm)	Height (mm)
SN75976A1MDGGREP	TSSOP	DGG	56	2000	346.0	346.0	41.0

DGG (R-PDSO-G**)

PLASTIC SMALL-OUTLINE PACKAGE

48 PINS SHOWN

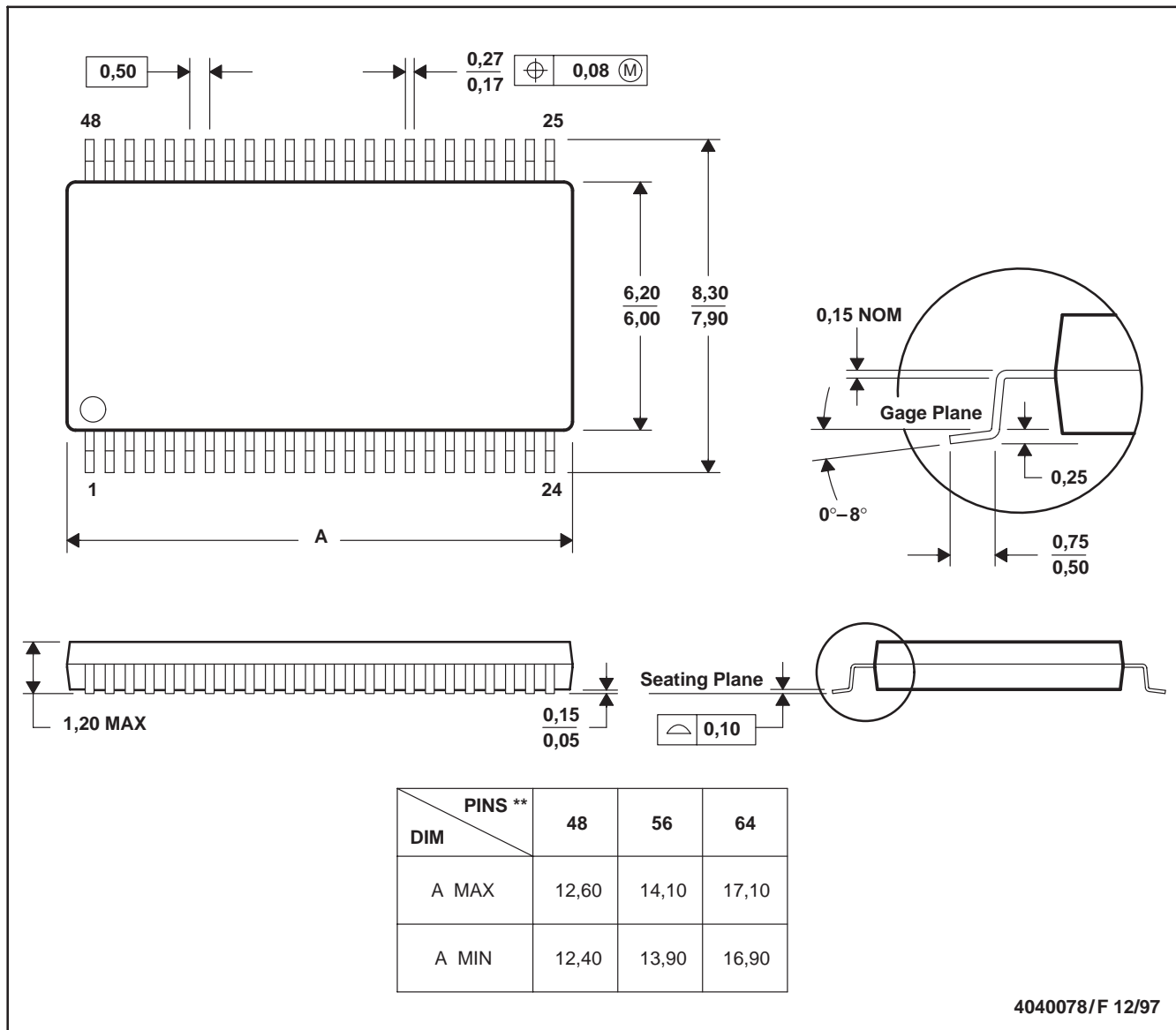

- NOTES: A. All linear dimensions are in millimeters.
 B. This drawing is subject to change without notice.
 C. Body dimensions do not include mold protrusion not to exceed 0,15.
 D. Falls within JEDEC MO-153

IMPORTANT NOTICE

Texas Instruments Incorporated and its subsidiaries (TI) reserve the right to make corrections, modifications, enhancements, improvements, and other changes to its products and services at any time and to discontinue any product or service without notice. Customers should obtain the latest relevant information before placing orders and should verify that such information is current and complete. All products are sold subject to TI's terms and conditions of sale supplied at the time of order acknowledgment.

TI warrants performance of its hardware products to the specifications applicable at the time of sale in accordance with TI's standard warranty. Testing and other quality control techniques are used to the extent TI deems necessary to support this warranty. Except where mandated by government requirements, testing of all parameters of each product is not necessarily performed.

TI assumes no liability for applications assistance or customer product design. Customers are responsible for their products and applications using TI components. To minimize the risks associated with customer products and applications, customers should provide adequate design and operating safeguards.

TI does not warrant or represent that any license, either express or implied, is granted under any TI patent right, copyright, mask work right, or other TI intellectual property right relating to any combination, machine, or process in which TI products or services are used. Information published by TI regarding third-party products or services does not constitute a license from TI to use such products or services or a warranty or endorsement thereof. Use of such information may require a license from a third party under the patents or other intellectual property of the third party, or a license from TI under the patents or other intellectual property of TI.

Reproduction of TI information in TI data books or data sheets is permissible only if reproduction is without alteration and is accompanied by all associated warranties, conditions, limitations, and notices. Reproduction of this information with alteration is an unfair and deceptive business practice. TI is not responsible or liable for such altered documentation. Information of third parties may be subject to additional restrictions.

Resale of TI products or services with statements different from or beyond the parameters stated by TI for that product or service voids all express and any implied warranties for the associated TI product or service and is an unfair and deceptive business practice. TI is not responsible or liable for any such statements.

TI products are not authorized for use in safety-critical applications (such as life support) where a failure of the TI product would reasonably be expected to cause severe personal injury or death, unless officers of the parties have executed an agreement specifically governing such use. Buyers represent that they have all necessary expertise in the safety and regulatory ramifications of their applications, and acknowledge and agree that they are solely responsible for all legal, regulatory and safety-related requirements concerning their products and any use of TI products in such safety-critical applications, notwithstanding any applications-related information or support that may be provided by TI. Further, Buyers must fully indemnify TI and its representatives against any damages arising out of the use of TI products in such safety-critical applications.

TI products are neither designed nor intended for use in military/aerospace applications or environments unless the TI products are specifically designated by TI as military-grade or "enhanced plastic." Only products designated by TI as military-grade meet military specifications. Buyers acknowledge and agree that any such use of TI products which TI has not designated as military-grade is solely at the Buyer's risk, and that they are solely responsible for compliance with all legal and regulatory requirements in connection with such use.

TI products are neither designed nor intended for use in automotive applications or environments unless the specific TI products are designated by TI as compliant with ISO/TS 16949 requirements. Buyers acknowledge and agree that, if they use any non-designated products in automotive applications, TI will not be responsible for any failure to meet such requirements.

Following are URLs where you can obtain information on other Texas Instruments products and application solutions:

Products

Amplifiers	amplifier.ti.com
Data Converters	dataconverter.ti.com
DSP	dsp.ti.com
Clocks and Timers	www.ti.com/clocks
Interface	interface.ti.com
Logic	logic.ti.com
Power Mgmt	power.ti.com
Microcontrollers	microcontroller.ti.com
RFID	www.ti-rfid.com
RF/IF and ZigBee® Solutions	www.ti.com/lprf

Applications

Audio	www.ti.com/audio
Automotive	www.ti.com/automotive
Broadband	www.ti.com/broadband
Digital Control	www.ti.com/digitalcontrol
Medical	www.ti.com/medical
Military	www.ti.com/military
Optical Networking	www.ti.com/opticalnetwork
Security	www.ti.com/security
Telephony	www.ti.com/telephony
Video & Imaging	www.ti.com/video
Wireless	www.ti.com/wireless

Mailing Address: Texas Instruments, Post Office Box 655303, Dallas, Texas 75265
Copyright © 2008, Texas Instruments Incorporated