

Wide bandwidth, dual bipolar operational amplifier

Datasheet - production data

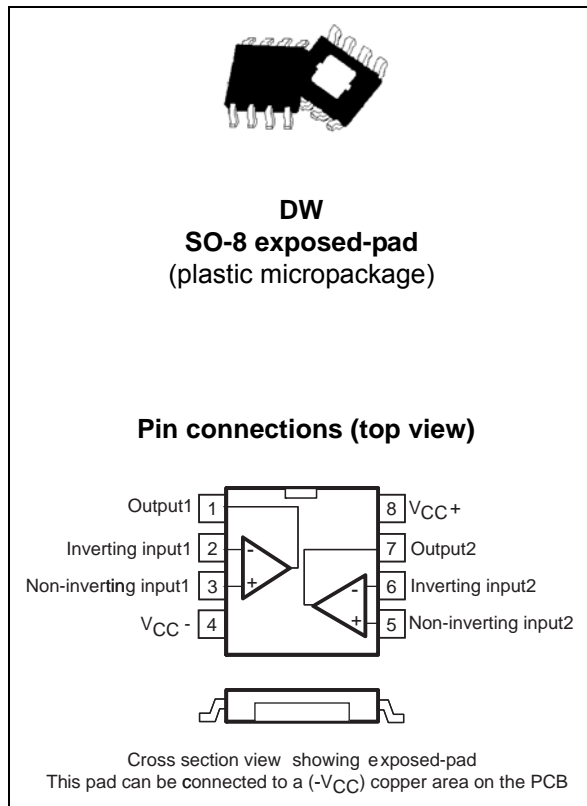

Description

The TS982 device is a dual operational amplifier able to drive 200 mA down to voltages as low as 2.7 V.

The SO-8 exposed-pad package allows high current output at high ambient temperatures making it a reliable solution for automotive and industrial applications.

The TS982 device is stable with a unity gain.

Features

- Operating from V_{CC} = 2.5 V to 5.5 V
- 200 mA output current on each amplifier
- High dissipation package
- Rail-to-rail input and output
- Unity gain stable

Applications

- Hall sensor compensation coils
- Servo amplifiers
- Motor drivers
- Industrial
- Automotive

Contents

- 1 Absolute maximum ratings and operating conditions 3**
- 2 Electrical characteristics 4**
- 3 Application information 14**
 - 3.1 Exposed-pad package description 14
 - 3.2 Exposed-pad electrical connection 14
 - 3.3 Thermal management benefits 15
 - 3.4 Thermal management guidelines 15
 - 3.5 Parallel operation 16
- 4 Package information 17**
 - 4.1 SO-8 exposed pad package information 17
- 5 Ordering information 19**
- 6 Revision history 20**

1 Absolute maximum ratings and operating conditions

Table 1. Absolute maximum ratings (AMR)

Symbol	Parameter	Value	Unit
V_{CC}	Supply voltage ⁽¹⁾	6	V
V_{in}	Input voltage	-0.3 V to $V_{CC} + 0.3$ V	V
T_{oper}	Operating free-air temperature range	-40 to + 125	°C
T_{stg}	Storage temperature	-65 to +150	°C
T_j	Maximum junction temperature	150	°C
R_{thja}	Thermal resistance junction to ambient ⁽²⁾	45	°C/W
R_{thjc}	Thermal resistance junction to case	10	°C/W
ESD	Human body model (HBM) ⁽³⁾	2	kV
	Charged device model (CDM) ⁽⁴⁾	1.5	kV
	Machine model (MM) ⁽⁵⁾	200	V
Latch-up	Latch-up immunity (all pins)	200	mA
	Lead temperature (soldering, 10 s)	250	°C
	Output short-circuit duration	See note ⁽⁶⁾	

- All voltage values are measured with respect to the ground pin.
- With two sides, two-plane PCB following the EIA/JEDEC JESD51-7 standard.
- Human body model: A 100 pF capacitor is charged to the specified voltage, then discharged through a 1.5 kΩ resistor between two pins of the device. This is done for all couples of connected pin combinations while the other pins are left floating.
- Charged device model: all pins and the package are charged together to the specified voltage and then discharged directly to the ground through only one pin. This is done for all pins.
- Machine model: A 200 pF capacitor is charged to the specified voltage, then discharged directly between two pins of the device with no external series resistor (internal resistor < 5 Ω). This is done for all couples of connected pin combinations while the other pins are left floating.
- Short-circuits can cause excessive heating. Destructive dissipation can result from a short-circuit on one or two amplifiers simultaneously.

Table 2. Operating conditions

Symbol	Parameter	Value	Unit
V_{CC}	Supply voltage	2.5 to 5.5	V
V_{icm}	Common mode input voltage range	GND to V_{CC}	V
C_L	Load capacitor		
	$R_L < 100 \Omega$ $R_L > 100 \Omega$	400 100	pF

2 Electrical characteristics

Table 3. Electrical characteristics for $V_{CC+} = +5\text{ V}$, $V_{CC-} = 0\text{ V}$, and $T_{\text{amb}} = 25\text{ °C}$ (unless otherwise specified)

Symbol	Parameter	Min.	Typ.	Max.	Unit
I_{CC}	Supply current - No input signal, no load $T_{\text{min}} < T_{\text{op}} < T_{\text{max}}$		5.5	7.2 7.2	mA
V_{IO}	Input offset voltage ($V_{\text{icm}} = V_{CC}/2$) $T_{\text{min}} < T_{\text{op}} < T_{\text{max}}$		1	5 7	mV
ΔV_{IO}	Input offset voltage drift		2		$\mu\text{V}/\text{°C}$
I_{IB}	Input bias current - $V_{\text{icm}} = V_{CC}/2$ $T_{\text{min}} < T_{\text{op}} < T_{\text{max}}$		200	500 500	nA
I_{IO}	Input offset current $V_{\text{icm}} = V_{CC}/2$		10		nA
V_{OH}	High level output voltage $R_L = 16\ \Omega$ $R_L = 16\ \Omega$, $T_{\text{min}} < T_{\text{op}} < T_{\text{max}}$ $I_{\text{out}} = 200\text{ mA}$	4.2 4	4.4 4		V
	$V_{CC} = 4.75\text{ V}$, $T = 125\text{ °C}$, $I_{\text{out}} = 25\text{ mA}$	4.3			V
V_{OL}	Low level output voltage $R_L = 16\ \Omega$ $R_L = 16\ \Omega$, $T_{\text{min}} < T_{\text{op}} < T_{\text{max}}$ $I_{\text{out}} = 200\text{ mA}$		0.55 1	0.65 0.95	V
	$V_{CC} = 4.75\text{ V}$, $T = 125\text{ °C}$, $I_{\text{out}} = 25\text{ mA}$			0.45	V
A_{VD}	Large signal voltage gain $R_L = 16\ \Omega$		95		dB
GBP	Gain bandwidth product $R_L = 32\ \Omega$	1.35	2.2		MHz
CMR	Common mode rejection ratio		80		dB
SVR	Supply voltage rejection ratio		95		dB
SR	Slew rate, unity gain inverting $R_L = 16\ \Omega$	0.45	0.7		V/ μs
Φ_m	Phase margin at unit gain $R_L = 16\ \Omega$, $C_L = 400\text{ pF}$		56		Degrees
G_m	Gain margin $R_L = 16\ \Omega$, $C_L = 400\text{ pF}$		18		dB
e_n	Equivalent input noise voltage $F = 1\text{ kHz}$		17		$\frac{\text{nV}}{\sqrt{\text{Hz}}}$
Crosstalk	Channel separation $R_L = 16\ \Omega$, $F = 1\text{ kHz}$		100		dB

**Table 4. Electrical characteristics for $V_{CC+} = +3.3\text{ V}$, $V_{CC-} = 0\text{ V}$, and $T_{\text{amb}} = 25\text{ }^{\circ}\text{C}$
(unless otherwise specified)⁽¹⁾**

Symbol	Parameter	Min.	Typ.	Max.	Unit
I_{CC}	Supply current - No input signal, no load $T_{\text{min}} < T_{\text{op}} < T_{\text{max}}$		5.3	7.2 7.2	mA
V_{IO}	Input offset voltage ($V_{\text{icm}} = V_{CC}/2$) $T_{\text{min}} < T_{\text{op}} < T_{\text{max}}$		1	5 7	mV
ΔV_{IO}	Input offset voltage drift		2		$\mu\text{V}/^{\circ}\text{C}$
I_{IB}	Input bias current - $V_{\text{icm}} = V_{CC}/2$ $T_{\text{min}} < T_{\text{op}} < T_{\text{max}}$		200	500 500	nA
I_{IO}	Input offset current $V_{\text{icm}} = V_{CC}/2$		10		nA
V_{OH}	High level output voltage $R_L = 16\ \Omega$ $R_L = 16\ \Omega, T_{\text{min}} < T_{\text{op}} < T_{\text{max}}$ $I_{\text{out}} = 200\text{ mA}$	2.68 2.64	2.85 2.3		V
V_{OL}	Low level output voltage $R_L = 16\ \Omega$ $R_L = 16\ \Omega, T_{\text{min}} < T_{\text{op}} < T_{\text{max}}$ $I_{\text{out}} = 200\text{ mA}$		0.45 1	0.52 0.65	V
A_{VD}	Large signal voltage gain $R_L = 16\ \Omega$		92		dB
GBP	Gain bandwidth product $R_L = 32\ \Omega$	1.2	2		MHz
CMR	Common mode rejection ratio		75		dB
SVR	Supply voltage rejection ratio		95		dB
SR	Slew rate, unity gain inverting $R_L = 16\ \Omega$	0.45	0.7		V/ μs
Φ_m	Phase margin at unit gain $R_L = 16\ \Omega, C_L = 400\text{ pF}$		57		Degrees
G_m	Gain margin $R_L = 16\ \Omega, C_L = 400\text{ pF}$		16		dB
e_n	Equivalent input noise voltage $F = 1\text{ kHz}$		17		$\frac{\text{nV}}{\sqrt{\text{Hz}}}$
Crosstalk	Channel separation $R_L = 16\ \Omega, F = 1\text{ kHz}$		100		dB

1. All electrical values are guaranteed by correlation with measurements at 2.7 V and 5 V.

Table 5. Electrical characteristics for $V_{CC} = +2.7\text{ V}$, $V_{CC-} = 0\text{ V}$, and $T_{amb} = 25\text{ °C}$ (unless otherwise specified)

Symbol	Parameter	Min.	Typ.	Max.	Unit
I_{CC}	Supply current - No input signal, no load $T_{min} < T_{op} < T_{ma}$		5.3	6.4 6.4	mA
V_{IO}	Input offset voltage ($V_{icm} = V_{CC}/2$) $T_{min} < T_{op} < T_{max}$		1	5 7	mV
ΔV_{IO}	Input offset voltage drift		2		$\mu\text{V}/\text{°C}$
I_{IB}	Input bias current - $V_{icm} = V_{CC}/2$ $T_{min} < T_{op} < T_{max}$		200	500 500	nA
I_{IO}	Input offset current $V_{icm} = V_{CC}/2$		10		nA
V_{OH}	High level output voltage $R_L = 16\ \Omega$ $R_L = 16\ \Omega, T_{min} < T_{op} < T_{max}$ $I_{out} = 20\text{ mA}$	2.3 2.25	2.85 2.3		V
V_{OL}	Low level output voltage $R_L = 16\ \Omega$ $R_L = 16\ \Omega, T_{min} < T_{op} < T_{max}$ $I_{out} = 200\text{ mA}$		0.45 1	0.37 0.42	V
A_{VD}	Large signal voltage gain $R_L = 16\ \Omega$		92		dB
GBP	Gain bandwidth product $R_L = 32\ \Omega$	1.2	2		MHz
CMR	Common mode rejection ratio		75		dB
SVR	Supply voltage rejection ratio		95		dB
SR	Slew rate, unity gain inverting $R_L = 16\ \Omega$	0.45	0.7		V/ μs
Φ_m	Phase margin at unit gain $R_L = 16\ \Omega, C_L = 400\text{ pF}$		57		Degrees
G_m	Gain margin $R_L = 16\ \Omega, C_L = 400\text{ pF}$		16		dB
e_n	Equivalent input noise voltage $F = 1\text{ kHz}$		17		$\frac{\text{nV}}{\sqrt{\text{Hz}}}$
Crosstalk	Channel separation $R_L = 16\ \Omega, F = 1\text{ kHz}$		100		dB

Figure 1. Current consumption vs. supply voltage

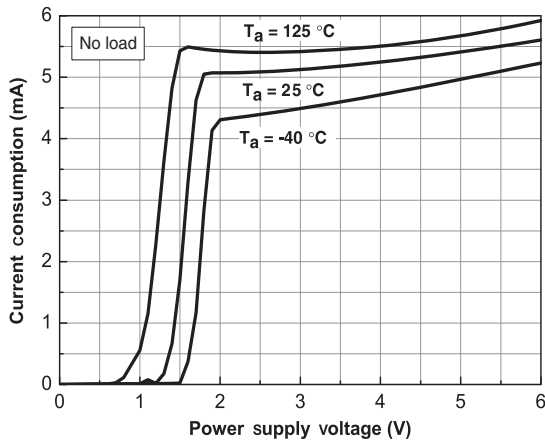

Figure 2. Voltage drop vs. output sourcing current

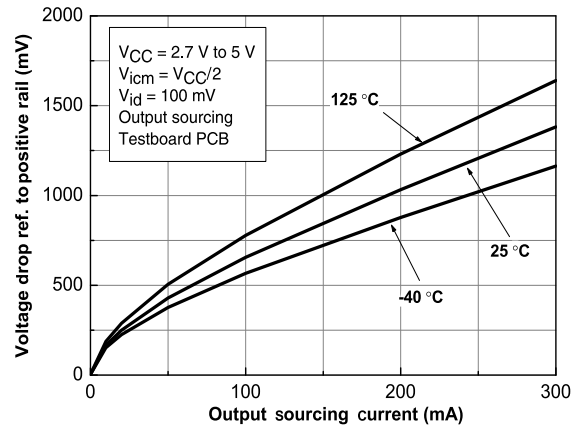

Figure 3. Voltage drop vs. output sinking current

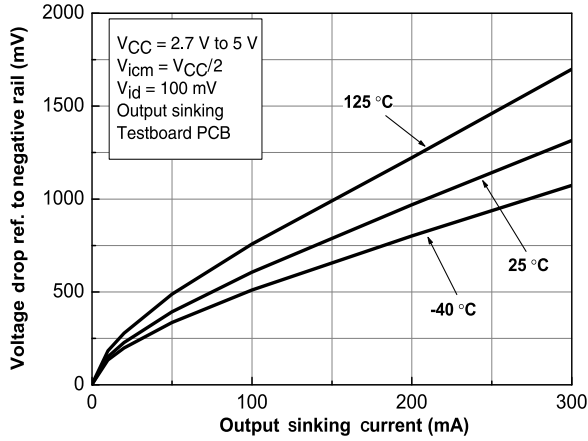

Figure 4. Voltage drop vs. supply voltage (sourcing)

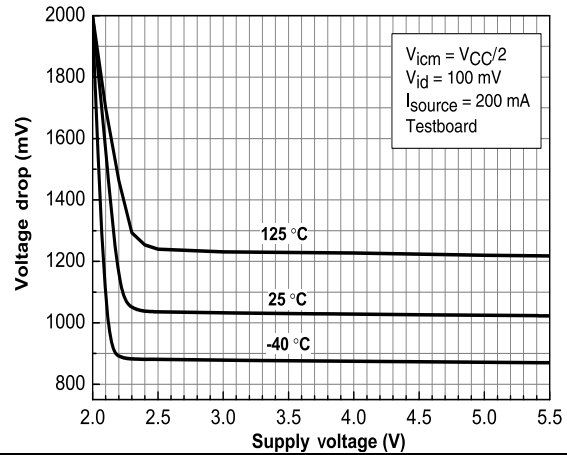

Figure 5. Voltage drop vs. supply voltage (sinking)

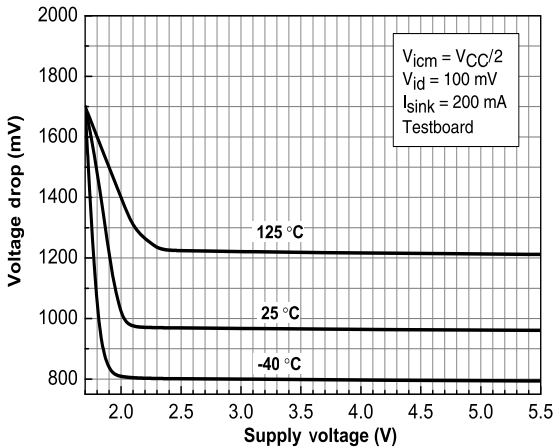
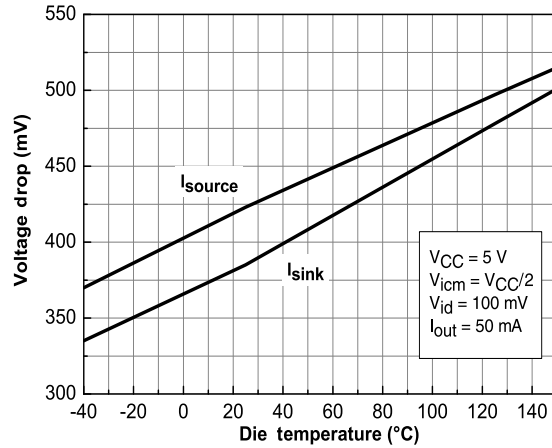

Figure 6. Voltage drop vs. temperature ($I_{out} = 50\text{ mA}$)



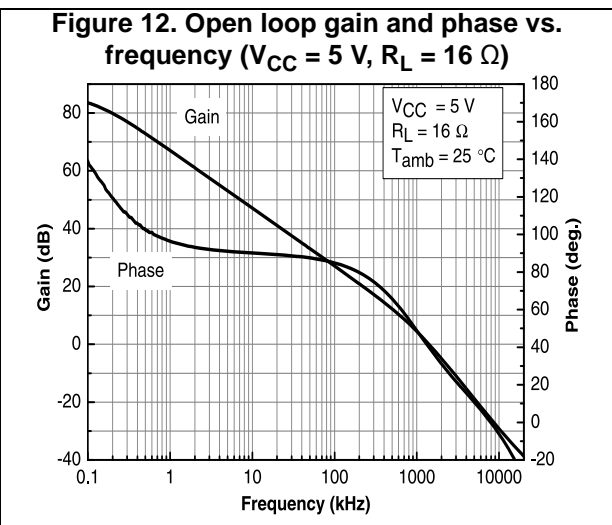
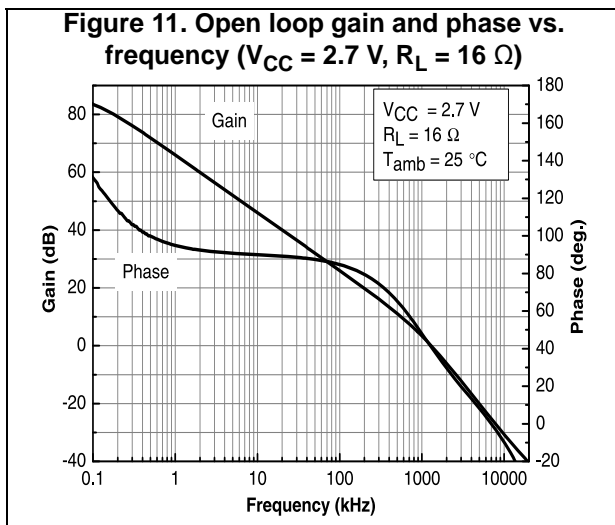
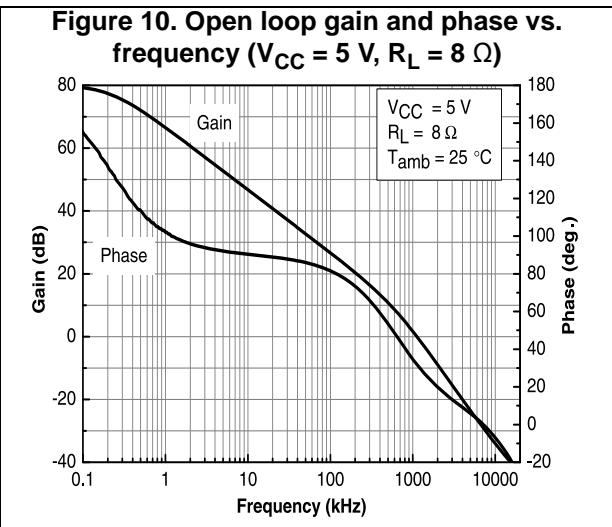
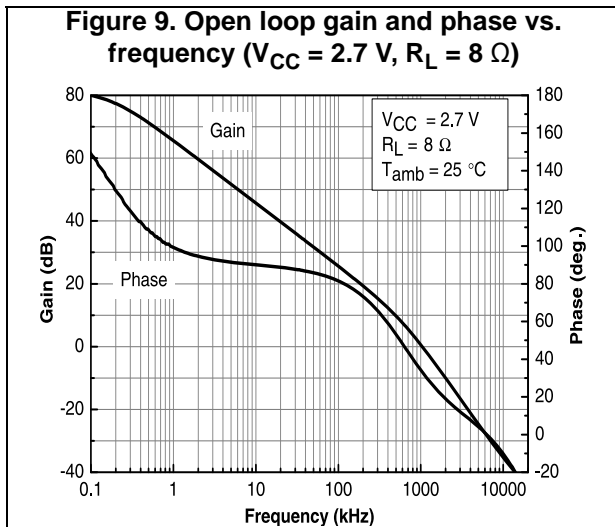
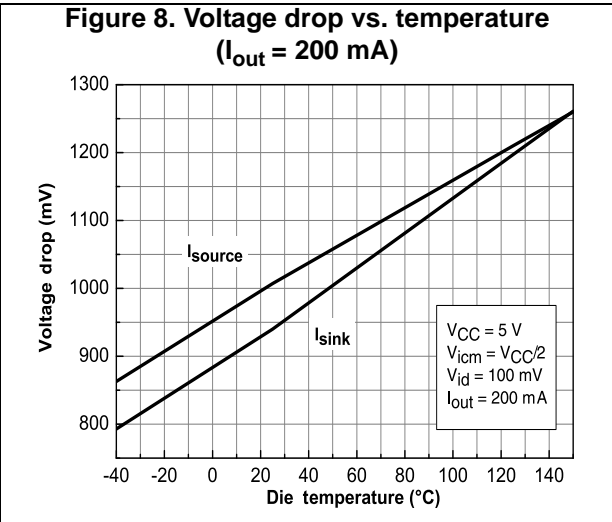
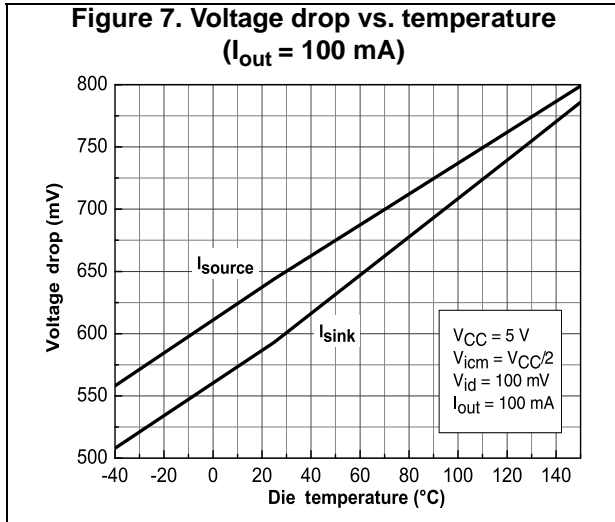

Figure 13. Open loop gain and phase vs. frequency ($V_{CC} = 2.7\text{ V}$, $R_L = 32\ \Omega$)

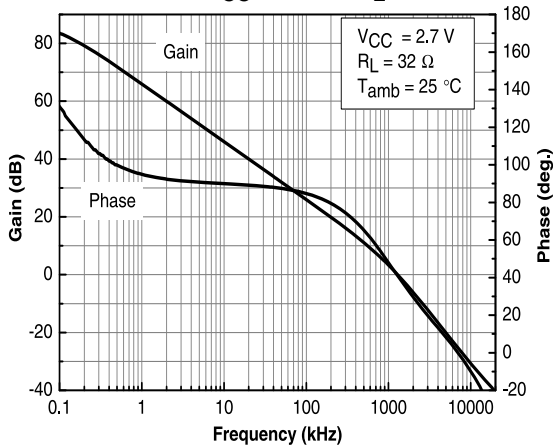

Figure 14. Open loop gain and phase vs. frequency ($V_{CC} = 5\text{ V}$, $R_L = 32\ \Omega$)

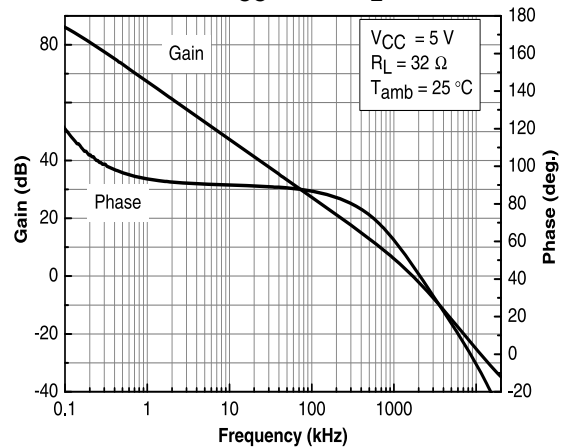

Figure 15. Open loop gain and phase vs. frequency ($V_{CC} = 2.7\text{ V}$, $R_L = 600\ \Omega$)

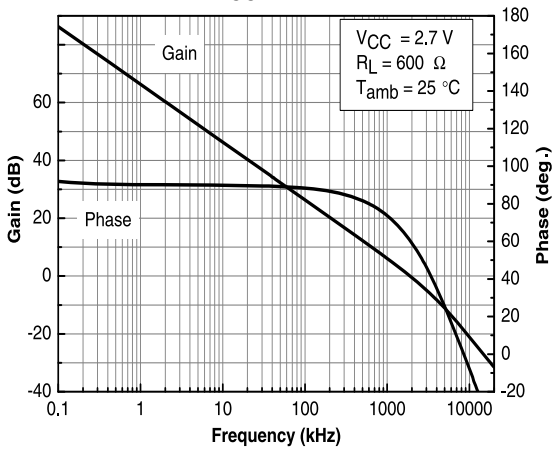

Figure 16. Open loop gain and phase vs. frequency ($V_{CC} = 5\text{ V}$, $R_L = 600\ \Omega$)

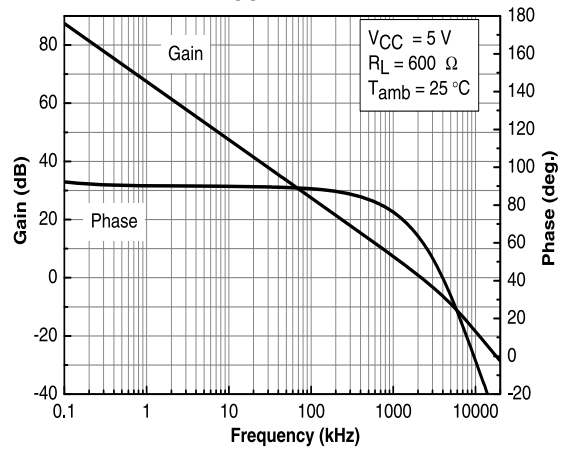

Figure 17. Open loop gain and phase vs. frequency ($V_{CC} = 2.7\text{ V}$, $R_L = 5\text{ k}\Omega$)

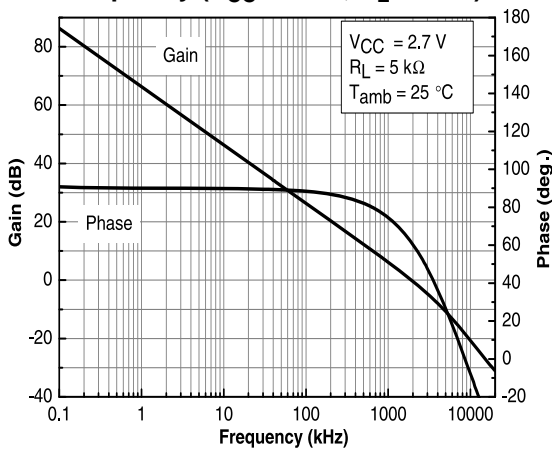
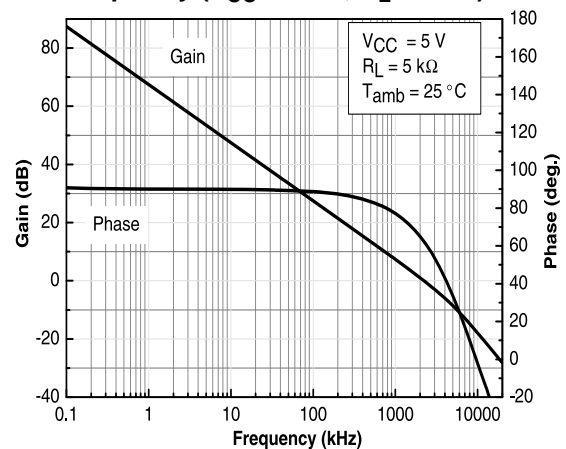
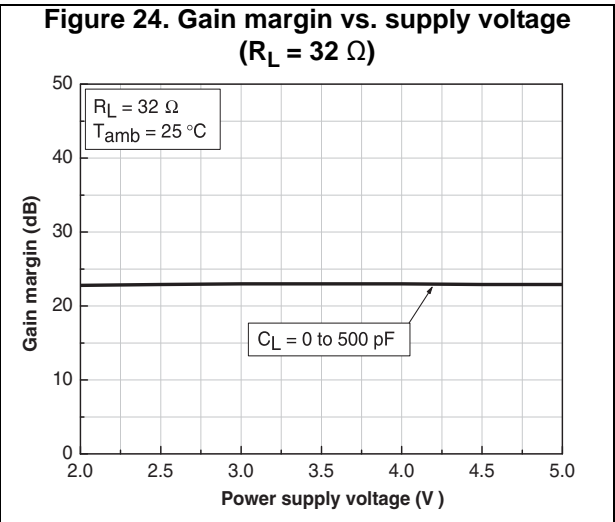
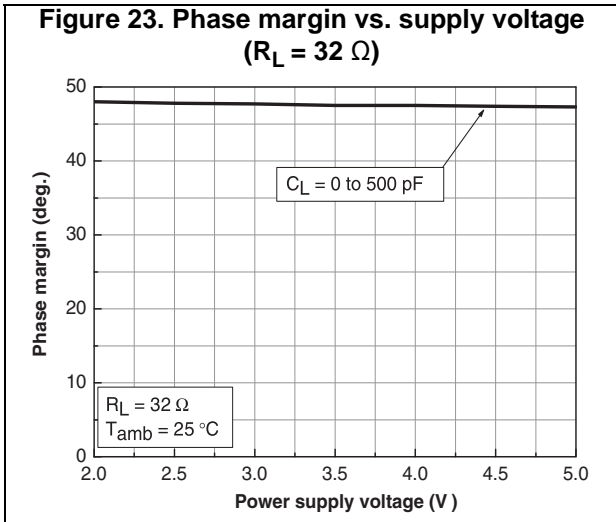
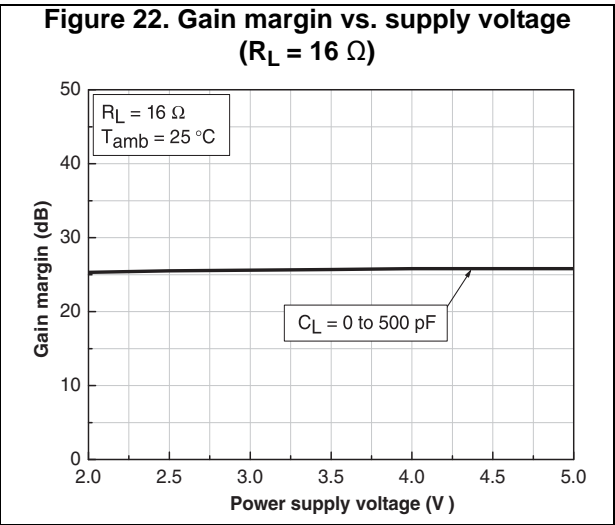
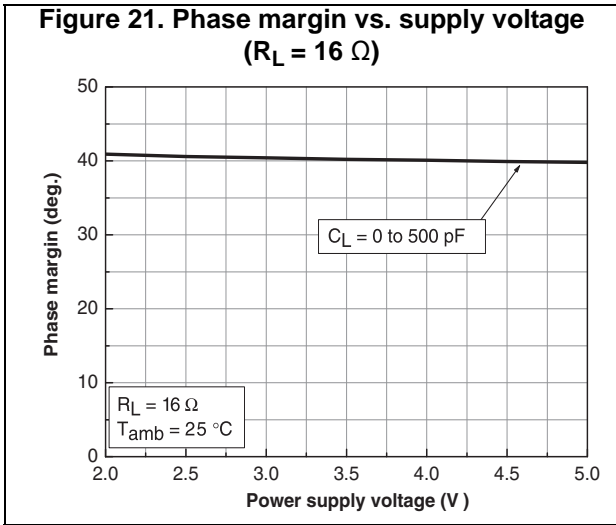
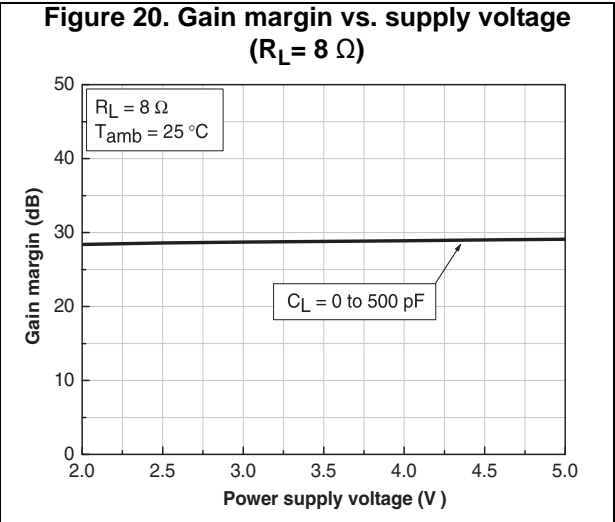
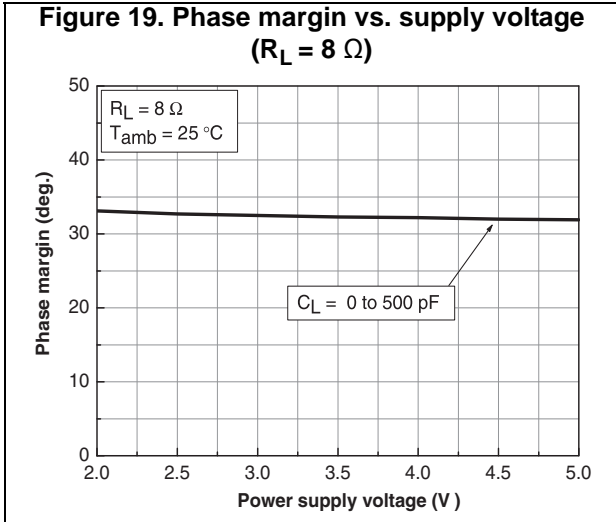
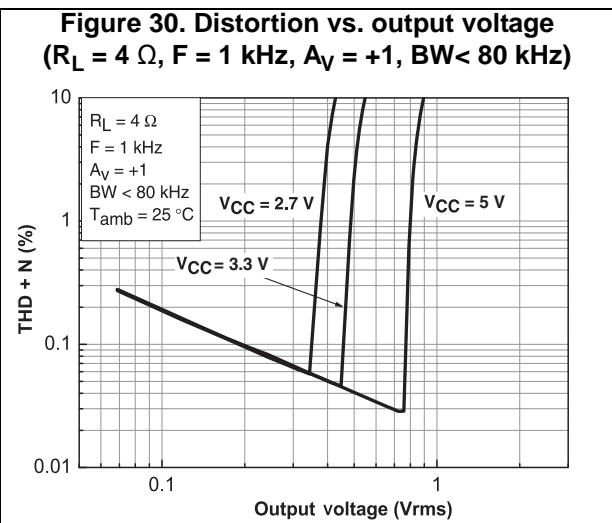
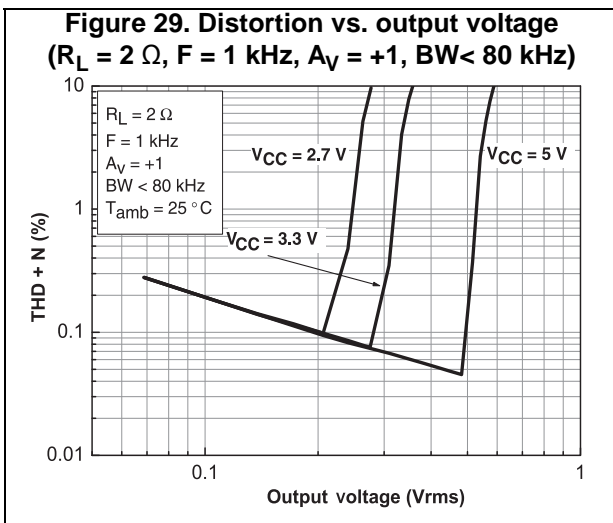
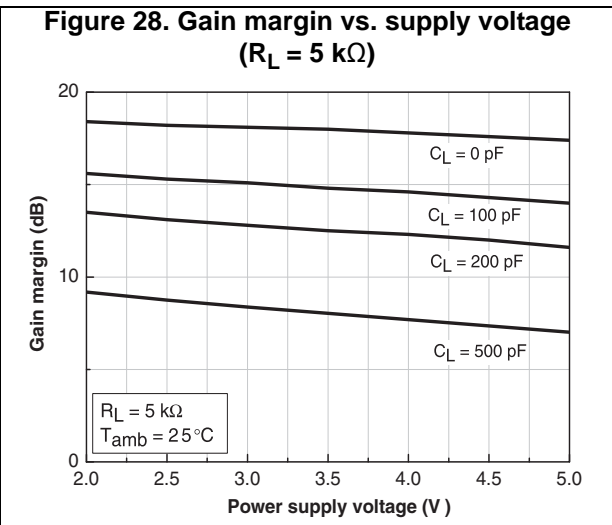
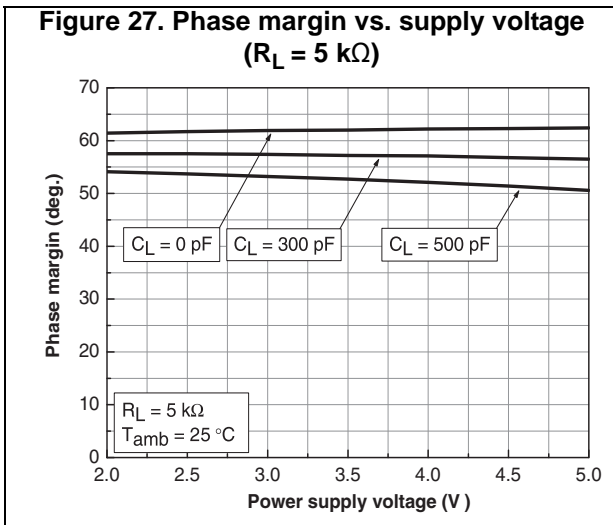
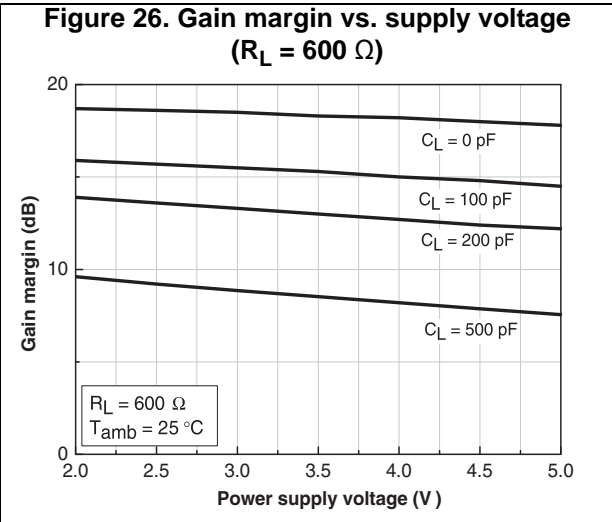
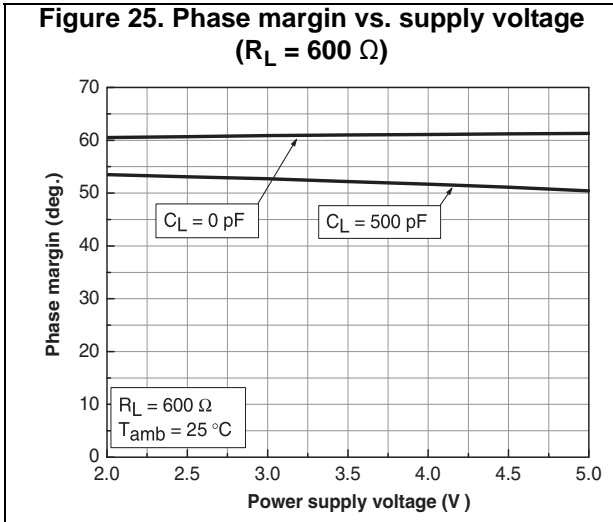
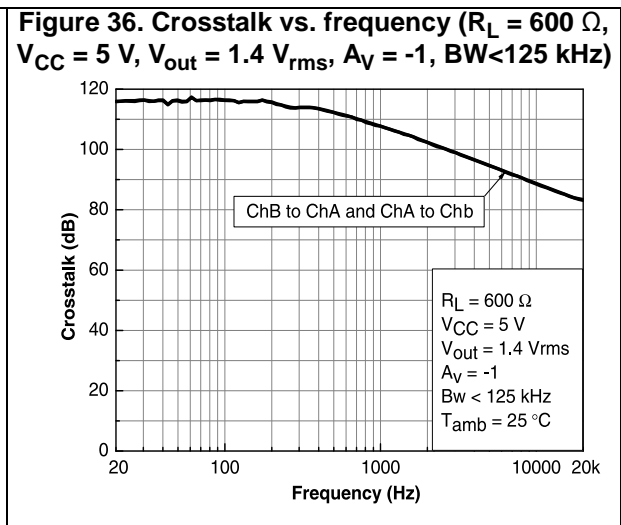
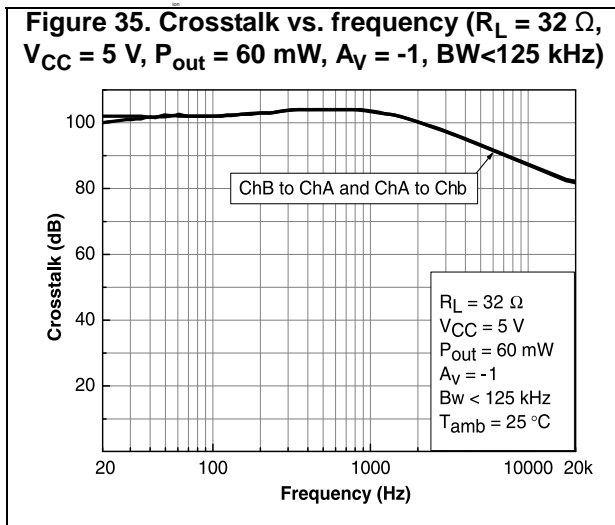
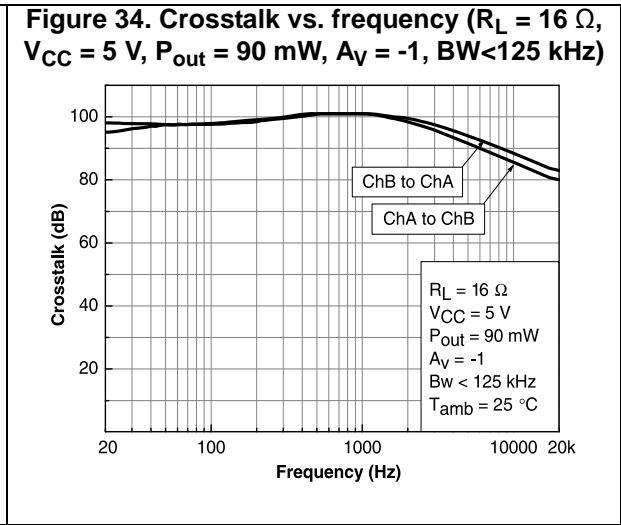
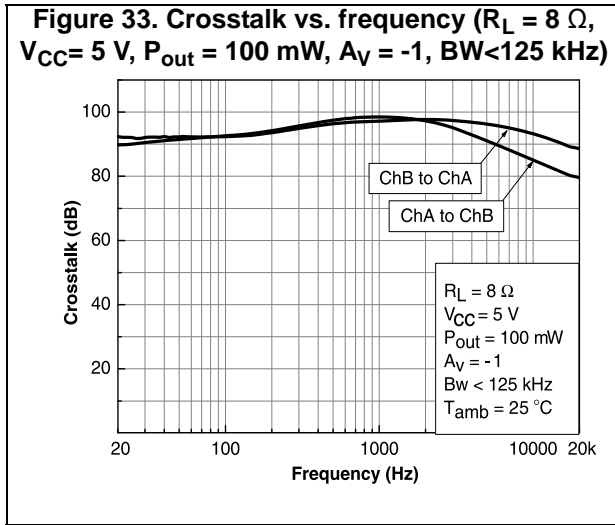
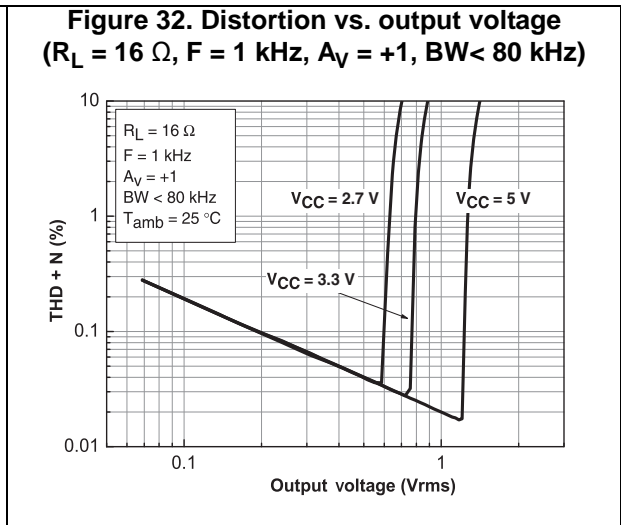
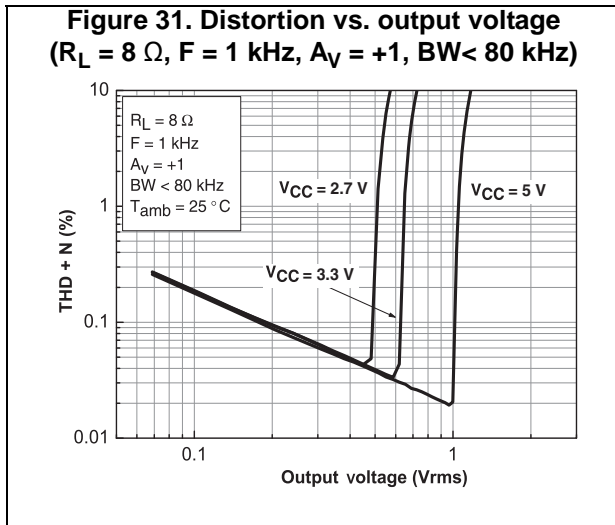

Figure 18. Open loop gain and phase vs. frequency ($V_{CC} = 5\text{ V}$, $R_L = 5\text{ k}\Omega$)









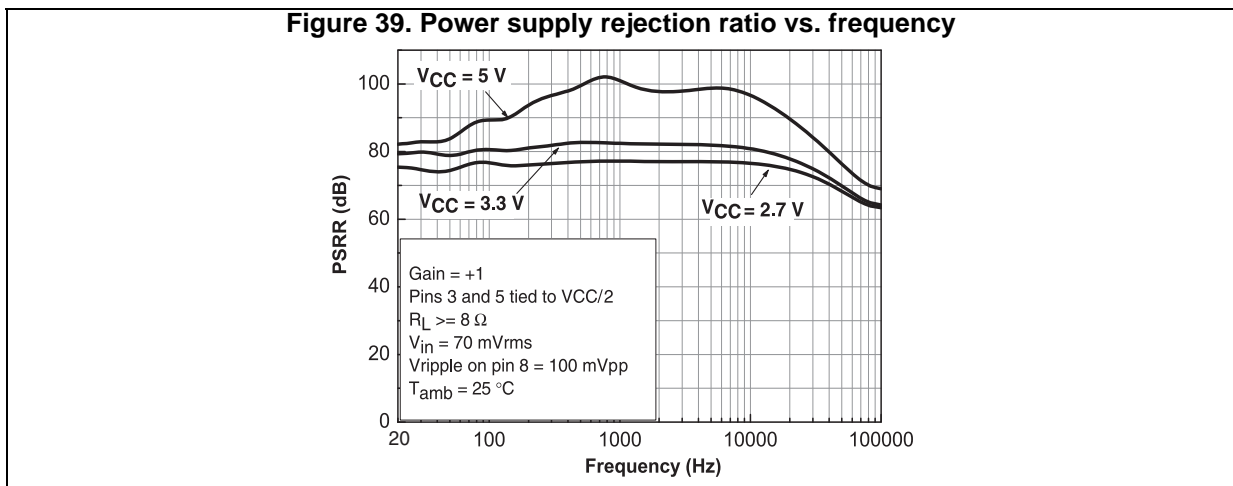
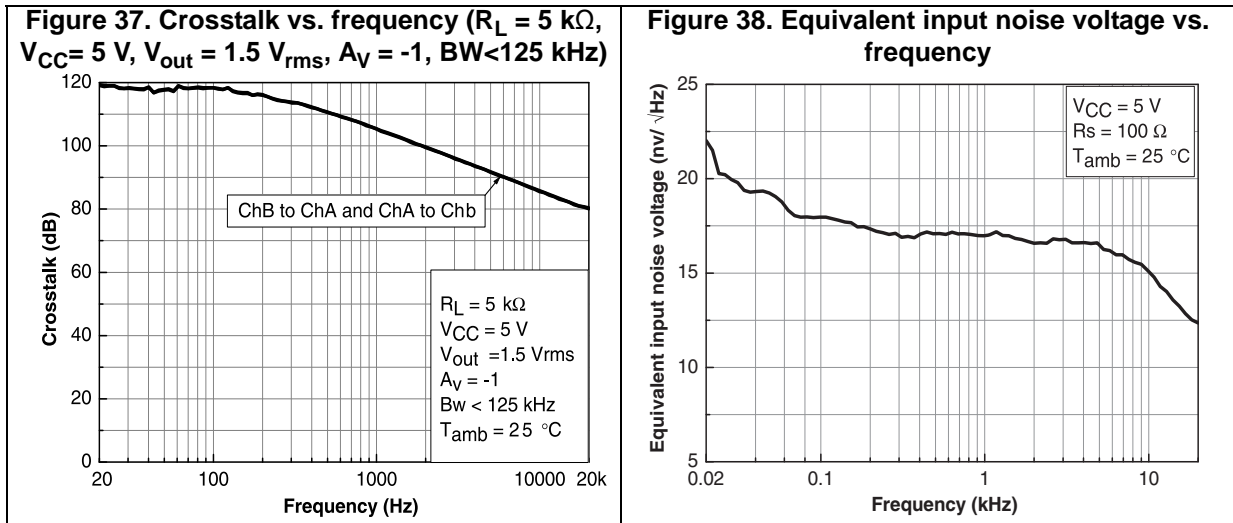

3 Application information

3.1 Exposed-pad package description

The dual operational amplifier TS982 is housed in an SO-8 exposed-pad plastic package. As shown in [Figure 40](#), the die is mounted and glued on a lead frame. This lead frame is exposed as a thermal pad on the underside of the package. The thermal contact is direct with the die and therefore, offers an excellent thermal performance in comparison with the common SO packages. The thermal contact between the die and the exposed-pad is characterized using the parameter R_{thjc} .

Figure 40. Exposed-pad plastic package

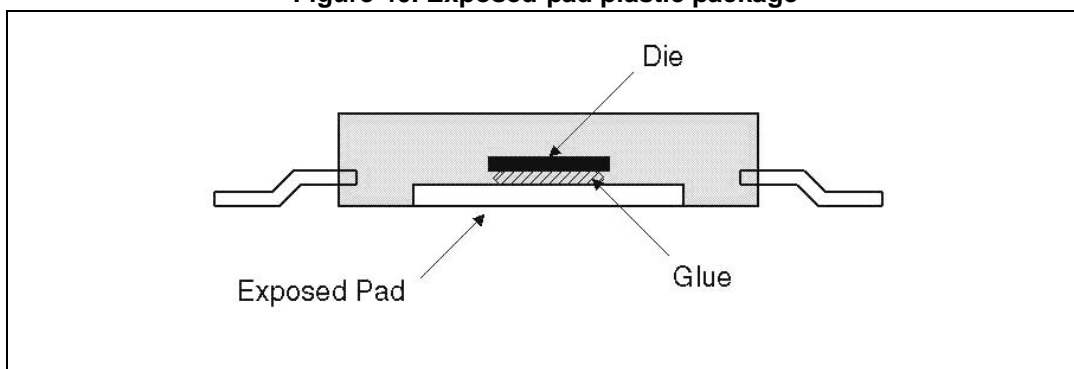

As 90% of the heat is removed through the pad, the thermal dissipation of the circuit is directly linked to the copper area soldered to the pad. In other words, the R_{thja} depends on the copper area and the number of layers of the printed circuit board under the pad.

Figure 41. TS982 test board layout - 6 cm² of copper topside

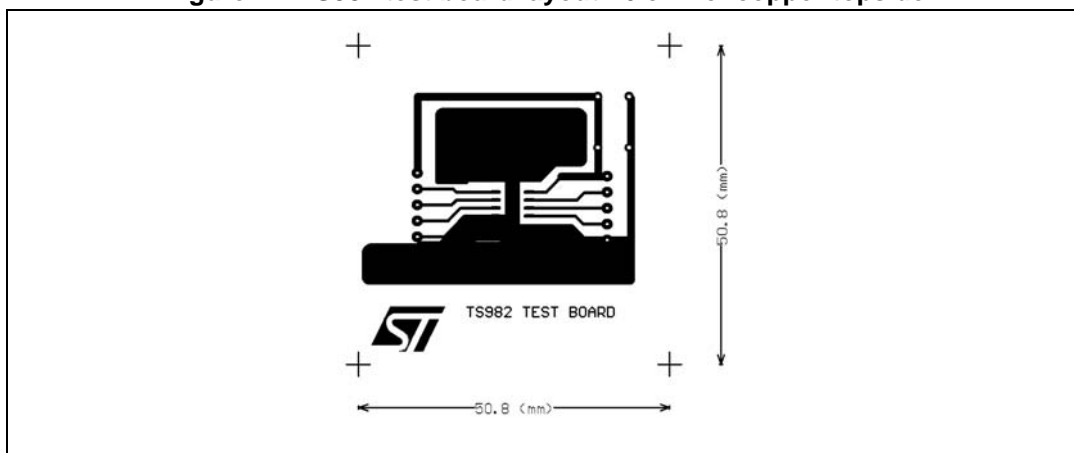

3.2 Exposed-pad electrical connection

In the SO-8 exposed-pad package, the silicon die is mounted on the thermal pad (see [Figure 40](#)). The silicon substrate is not directly connected to the pad because of the glue. Therefore, the copper area of the exposed-pad must be connected to the substrate voltage (V_{CC^-}) pin 4.

3.3 Thermal management benefits

A good thermal design is important to maintain the temperature of the silicon junction below $T_j = 150\text{ °C}$ as given in the absolute maximum ratings and also to maintain the operating power level.

Another effect of temperature is that the life expectancy of an integrated circuit decreases exponentially when operating at high temperature over an extended period of time. It is estimated that, the chip failure rate doubles for every 10 to 20 °C. This demonstrates that reducing the junction temperature is also important to improve the reliability of the amplifier.

Because of the high dissipation capability of the SO-8 exposed-pad package, the dual op amp TS982 has a lower junction temperature for high current applications in high ambient temperatures.

3.4 Thermal management guidelines

The following guidelines are a simple procedure to determine the PCB you should use in order to get the best from the SO-8 exposed-pad package:

1. Determine the total power P_{total} to be dissipated by the IC.

$$P_{\text{total}} = I_{\text{CC}} \times V_{\text{CC}} + V_{\text{drop1}} \times I_{\text{out1}} + V_{\text{drop2}} \times I_{\text{out2}}$$

$I_{\text{CC}} \times V_{\text{CC}}$ is the DC power needed by the TS982 to operate with no load. Refer to [Figure 1: Current consumption vs. supply voltage on page 7](#) to determine I_{CC} versus V_{CC} and versus temperature.

The other terms are the power dissipated by the two operators to source the load. If the output signal can be assimilated to a DC signal, you can calculate the dissipated power using the voltage drop curves versus output current, supply voltage, and temperature ([Figure 2 on page 7](#) to [Figure 8 on page 8](#)).

2. Specify the maximum operating temperature, (T_a) of the TS982.
3. Specify the maximum junction temperature (T_j) at the maximum output power. As discussed above, T_j must be below 150 °C and as low as possible for reliability considerations.

Therefore, the maximum thermal resistance between junction and ambient R_{thja} is:

$$R_{\text{thja}} = (T_j - T_a) / P_{\text{total}}$$

Different PCBs can give the right R_{thja} for a given application. [Figure 42](#) gives the R_{thja} of the SO-8 exposed pad versus the copper area of a top side PCB.

Figure 42. R_{thja} of the TS982 vs. top side copper area

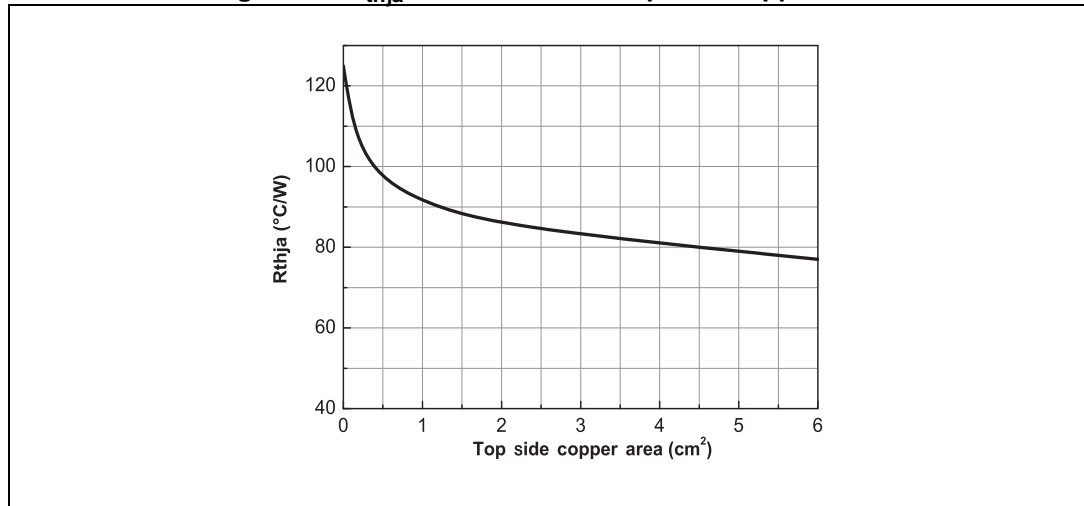

The ultimate R_{thja} of the package on a 4-layer PCB under natural convection conditions, is 45 °C/W by using two power planes and metallized holes.

3.5 Parallel operation

Using the two amplifiers of the TS982 device in parallel mode provides a higher output current: 400 mA.

Figure 43. Parallel operation - 400 mA output current

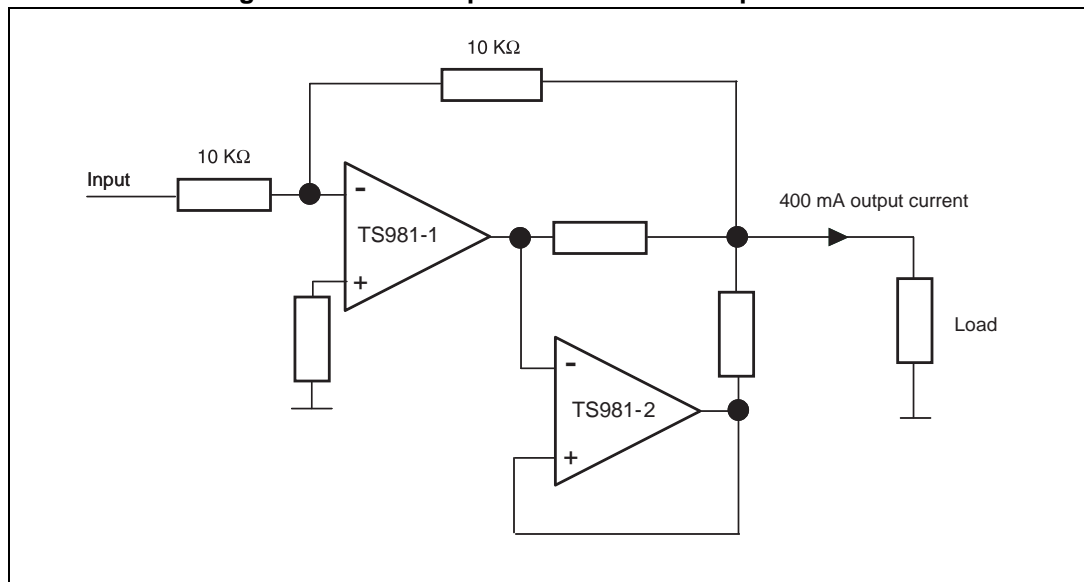

4 Package information

In order to meet environmental requirements, ST offers these devices in different grades of ECOPACK® packages, depending on their level of environmental compliance. ECOPACK specifications, grade definitions and product status are available at: www.st.com. ECOPACK is an ST trademark.

4.1 SO-8 exposed pad package information

Figure 44. SO-8 exposed pad package outline

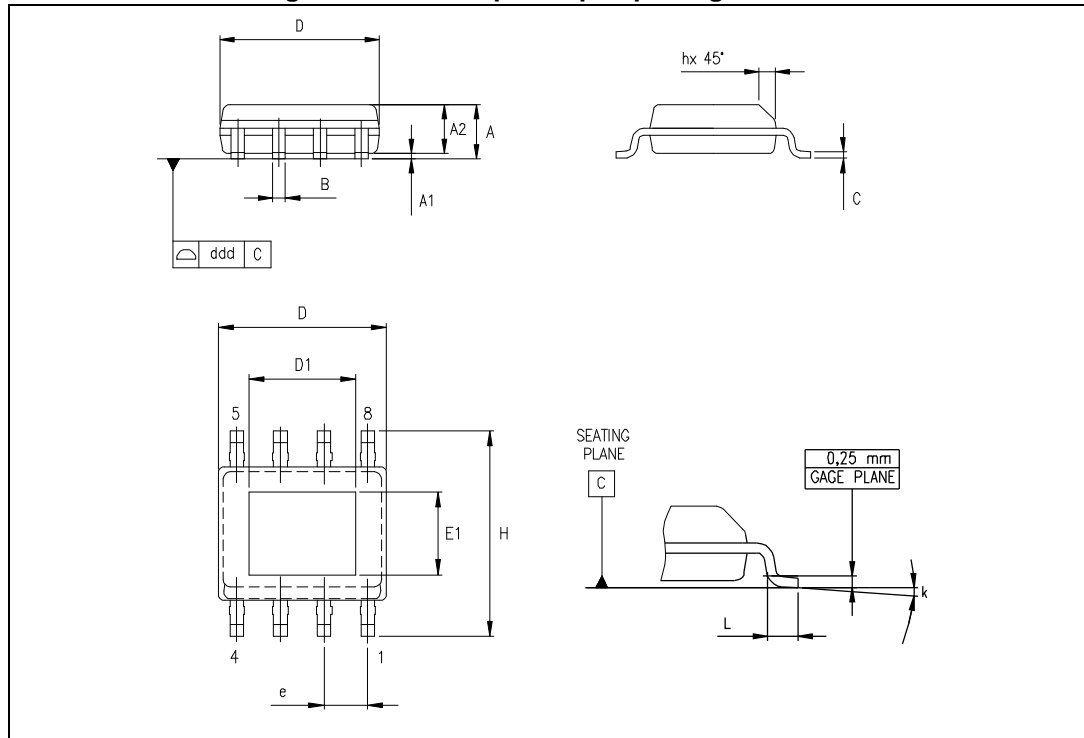

Table 6. SO-8 exposed pad package mechanical data

Symbol	Dimensions					
	Millimeters			Inches		
	Min.	Typ.	Max.	Min.	Typ.	Max.
A	1.35		1.75	0.053		0.069
A1	0.10		0.15	0.04		0.059
A2	1.10		1.65	0.043		0.065
B	0.33		0.51	0.013		0.020
C	0.19		0.25	0.007		0.010
D	4.80		5.00	0.189		0.197
D1	3.1			0.122		
E	3.80		4.00	0.150		0.157
E1	2.41			0.095		
e		1.27			0.050	
H	5.80		6.20	0.228		0.244
h	0.25		0.50	0.010		0.020
L	0.40		1.27	0.016		0.050
k	8° (max.)					
ddd			0.1			0.04

5 Ordering information

Table 7. Order code

Order code	Temperature range	Package	Packing	Marking
TS982IDWT	-40 °C to +125 °C	SO-8 exposed-pad	Tape and reel	TS982I
TS982IYDWT ⁽¹⁾		SO-8 exposed-pad (automotive-grade)	Tape and reel	TS982IY

1. Qualified and characterized according to AEC Q100 and Q003 or equivalent, advanced screening according to AEC Q001 and Q002 or equivalent.

6 Revision history

Table 8. Document revision history

Date	Revision	Changes
02-Jan-2004	1	First release.
01-Feb-2004	2	Order codes modified on cover page.
01-Dec-2005	3	PPAP references inserted in the datasheet see <i>Table 4: Ordering information on page 19</i> .
02-Apr-2006	4	V_{OH} and V_{OL} limits (at $V_{CC} = 4.75\text{ V}$, $T_{amb} = 125^\circ\text{ C}$) added in <i>Table 3. on page 4</i> .
24-Oct-2006	5	Corrections to <i>Section 2.3: Thermal management benefits</i> and <i>Section 2.4: Thermal management guidelines on page 15</i> . Pad size added to package mechanical data table under SO-8 exposed pad package outline on page 18, and stand-off value corrected. Corrected value of V_{OH} for $V_{CC} = 2.7\text{ V}$.
5-Jun-2008	6	Moved ordering information from cover page to end of document. Added footnotes for ESD parameters in <i>Table 1: Absolute maximum ratings (AMR)</i> . Added footnote for automotive grade parts in <i>Table 7: Order codes</i> .
28-Aug-2012	7	Corrected numbering of tables, added conditions to titles of <i>Figure 9</i> to <i>Figure 37</i> , updated ECOPACK text, removed TS982IDW and TS982IYDW device from <i>Table 7</i> , minor corrections throughout document.
10-Mar-2014	8	Updated R_{thjc} in <i>Table 1: Absolute maximum ratings (AMR)</i> .
15-Mar-2018	9	Updated R_{thjc} in <i>Table 1: Absolute maximum ratings (AMR)</i>

IMPORTANT NOTICE – PLEASE READ CAREFULLY

STMicroelectronics NV and its subsidiaries ("ST") reserve the right to make changes, corrections, enhancements, modifications, and improvements to ST products and/or to this document at any time without notice. Purchasers should obtain the latest relevant information on ST products before placing orders. ST products are sold pursuant to ST's terms and conditions of sale in place at the time of order acknowledgement.

Purchasers are solely responsible for the choice, selection, and use of ST products and ST assumes no liability for application assistance or the design of Purchasers' products.

No license, express or implied, to any intellectual property right is granted by ST herein.

Resale of ST products with provisions different from the information set forth herein shall void any warranty granted by ST for such product.

ST and the ST logo are trademarks of ST. All other product or service names are the property of their respective owners.

Information in this document supersedes and replaces information previously supplied in any prior versions of this document.

© 2018 STMicroelectronics – All rights reserved

Mouser Electronics

Authorized Distributor

Click to View Pricing, Inventory, Delivery & Lifecycle Information:

[STMicroelectronics:](#)

[TS982IDW](#) [TS982IDWT](#) [TS982IYDWT](#)