

FEATURES

- Automatically restarts microprocessor after power failure
- Maintains reset for 350 ms after V_{CC} returns to an in-tolerance condition
- Reduces need for discrete components
- Precision temperature-compensated voltage reference and voltage sensor
- Low-cost TO-92 package or surface mount 8-pin SOIC packages available
- Internal 5 k Ω pullup resistor
- Compatible with Motorola 68XXX series and HC16 Microprocessors
- Pin function compatible with the Motorola MC33064, MC34064, MC33164, and MC34164
- Operating temperature of -40°C to +85°C

PIN ASSIGNMENT

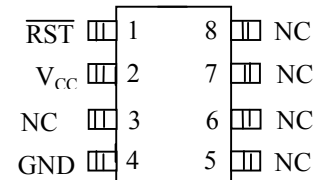
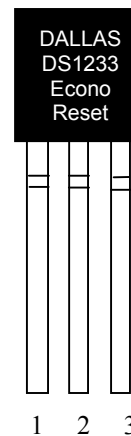

DS1233M 8-Pin SOIC
(150mil)
See Mech. Drawings
Section on Website

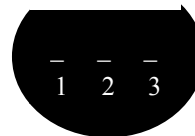

BOTTOM VIEW
TO-92 PACKAGE
See Mech.
Drawings Section
On Website

PIN DESCRIPTIONS

TO-92

- | | |
|--------------------|---------------------------|
| 1 \overline{RST} | - Active Low Reset Output |
| 2 V_{CC} | - Power Supply |
| 3 GND | - Ground |

8-Pin SOIC

- | | |
|------------------|---------------------------|
| \overline{RST} | - Active Low Reset Output |
| V_{CC} | - Power Supply |
| NC | - No Connect |
| GND | - Ground |

DESCRIPTION

The DS1233M EconoReset uses a precision temperature-compensated reference and comparator circuit to monitor the status of the power supply (V_{CC}). When an out-of-tolerance condition is detected, an internal power-fail signal is generated which forces reset to the active (low) state. When V_{CC} returns to an in-tolerance condition, the reset signal is kept in the active state for approximately 350 ms to allow the power supply and processor to stabilize.

OPERATION - POWER MONITOR

The DS1233M provides the functions of detecting out-of-tolerance power supply conditions and warning a processor-based system of impending power failure. When V_{CC} is detected as out-of-tolerance, as defined by the tolerance of the part selected, the \overline{RST} signal is asserted. On power-up, \overline{RST} is kept active for approximately 350 ms after the power supply has reached the selected tolerance. This allows the power supply and microprocessor to stabilize before \overline{RST} is released.

BLOCK DIAGRAM Figure 1

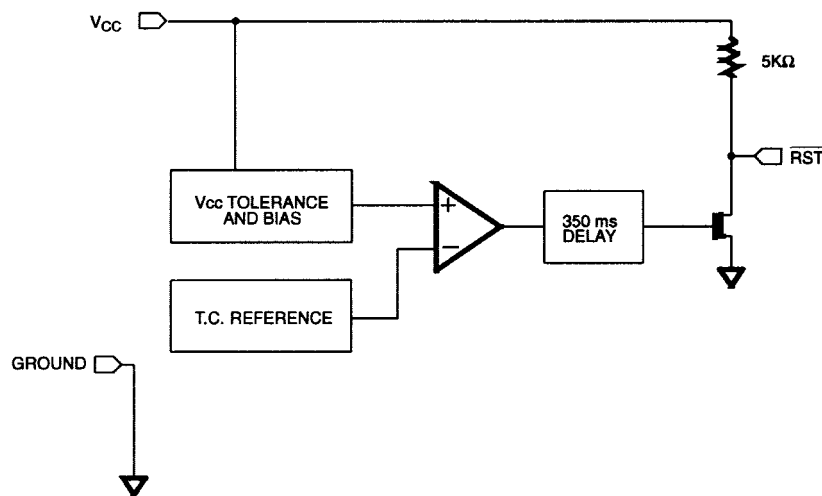

APPLICATION EXAMPLE Figure 2

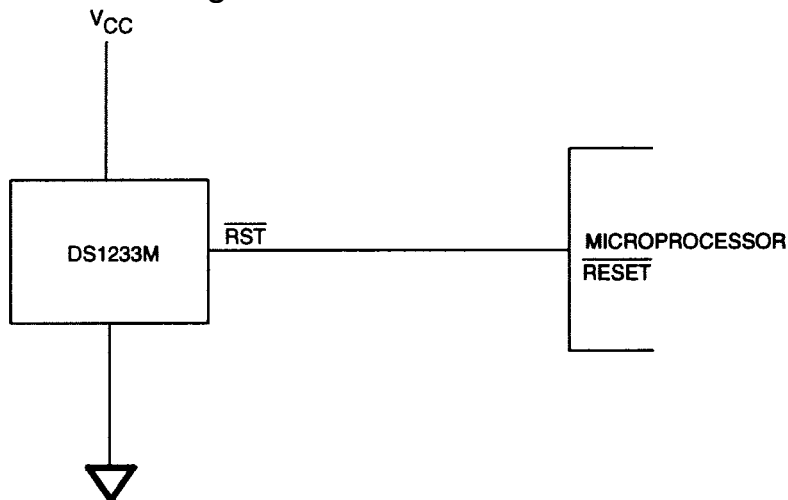

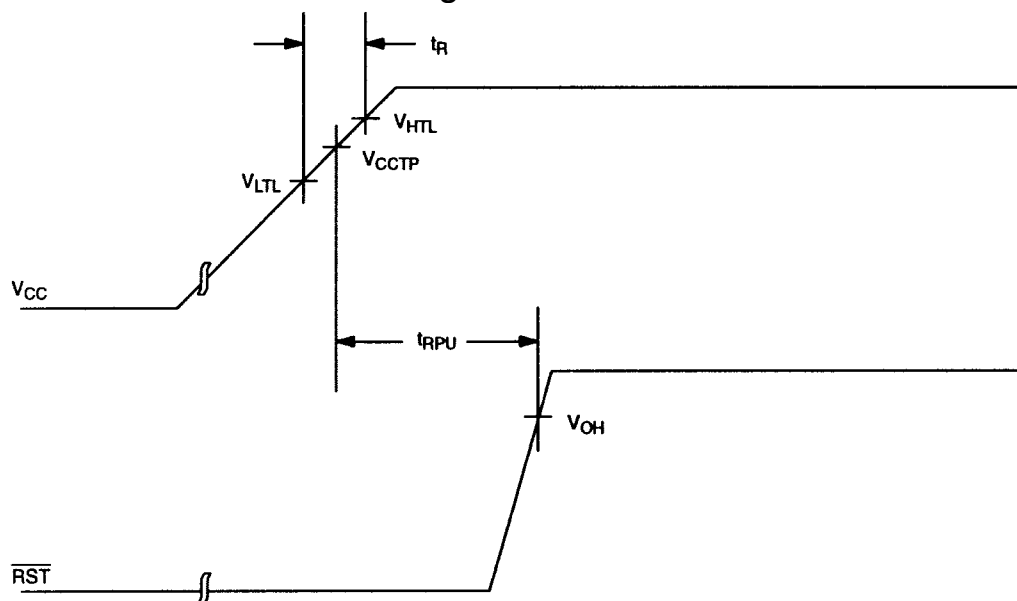
TIMING DIAGRAM: POWER-UP Figure 3**VOLTAGE TRIP LEVELS**

PARAMETER	SYMBOL	MIN	TYP	MAX	UNITS	NOTES
Voltage High Trip Level	V_{HTL}			4.75	V	DS1233M-5, DS1233M-55
Voltage Low Trip Level	V_{LTL}			4.00	V	DS1233M-5, DS1233M-55
Voltage High Trip Level	V_{HTL}			3.14	V	DS1233M-3
Voltage Low Trip Level	V_{LTL}			2.48	V	DS1233M-3

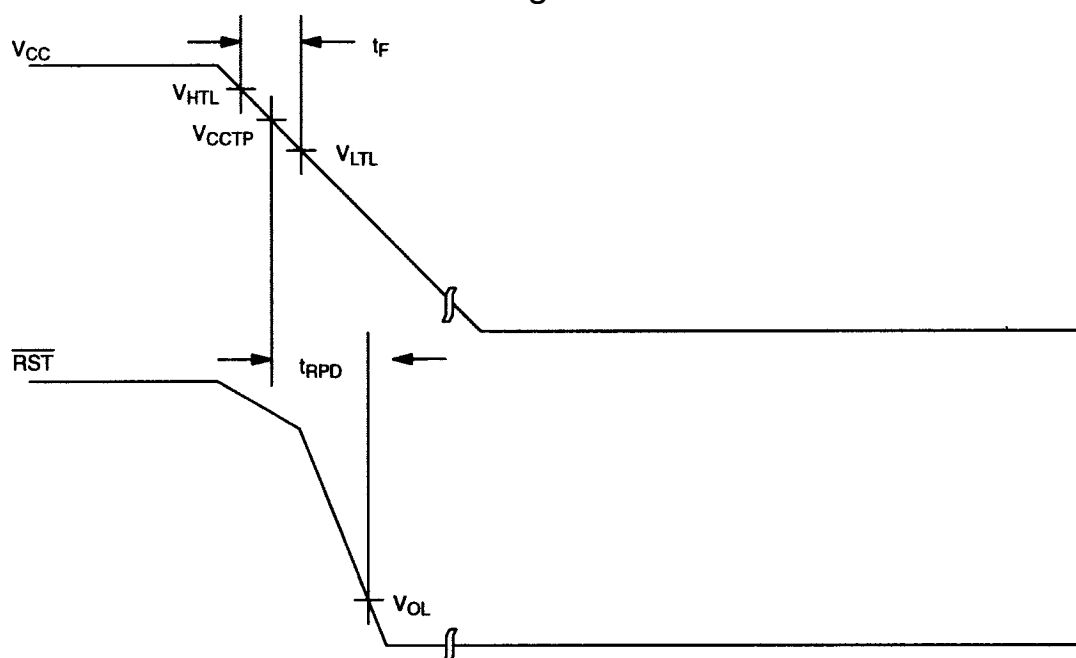
TIMING DIAGRAM: POWER-DOWN Figure 4

ABSOLUTE MAXIMUM RATINGS*

Voltage on V_{CC} Pin Relative to Ground	-0.5V to +7.0V
Voltage on I/O Relative to Ground	-0.5V to $V_{CC} + 0.5V$
Operating Temperature	-40°C to +85°C
Storage Temperature	-55°C to +125°C
Soldering Temperature	260°C for 10 seconds

* This is a stress rating only and functional operation of the device at these or any other conditions above those indicated in the operation sections of this specification is not implied. Exposure to absolute maximum rating conditions for extended periods of time may affect reliability.

RECOMMENDED DC OPERATING CONDITIONS (-40°C to +85°C)

PARAMETER	SYMBOL	MIN	TYP	MAX	UNITS	NOTES
Supply Voltage	V_{CC}	1.2		5.5	V	1

DC ELECTRICAL CHARACTERISTICS (-40°C to +85°C; $V_{CC} = 1.2V$ to 5.5V)

PARAMETER	SYMBOL	MIN	TYP	MAX	UNITS	NOTES
Output Voltage @ -500 μA	V_{OH}	$V_{CC}-0.5V$	$V_{CC}-0.1V$		V	1
Output Current @ 0.4V	I_{OL}	+8			mA	2,3
Operating Current	I_{CC}			50	μA	4
V_{CC} Trip Point (DS1233M-5)	V_{CCTP}	4.25	4.375	4.49	V	1
V_{CC} Trip Point (DS1233M-55)	V_{CCTP}	4.5	4.625	4.75	V	1
V_{CC} Trip Point (DS1233M-3)	V_{CCTP}	2.64	2.72	2.8	V	1
Output Capacitance	C_{OUT}			10	pF	
Internal Pullup Resistor	R_P	3.75	5	6.50	k Ω	

AC ELECTRICAL CHARACTERISTICS (-40°C to +85°C; $V_{CC} = 1.2V$ to 5.5V)

PARAMETER	SYMBOL	MIN	TYP	MAX	UNITS	NOTES
Reset Active Time	t_{RST}	200	350	500	ms	
V_{CC} Detect to \overline{RST}	t_{RPD}		2	10	μs	
V_{CC} Slew Rate ($V_{HTL} - V_{LTL}$)	t_F	300			μs	
V_{CC} Slew Rate ($V_{LTL} - V_{HTL}$)	t_R	0			ns	
V_{CC} Detect to RST	t_{RPU}	200	350	500	ms	5

NOTES:

- All voltages are referenced to ground.
- Measured with $V_{CC} \geq 2.7V$.
- A 1 k Ω external resistor may be required in some applications for proper operation of the microprocessor reset control circuit.
- Measured with outputs open.
- $t_R = 5 \mu s$.

Mouser Electronics

Authorized Distributor

Click to View Pricing, Inventory, Delivery & Lifecycle Information:

Maxim Integrated:

[DS1233M-5+](#) [DS1233M-55+](#) [DS1233MS-3+](#) [DS1233MS-5+](#) [DS1233MS-55+](#) [DS1233M-3](#) [DS1233M-3+](#)
[DS1233M-3+T&R](#) [DS1233M-5](#) [DS1233M-5+T&R](#) [DS1233M-5/T&R](#) [DS1233M-55](#) [DS1233M-55+T&R](#) [DS1233M-](#)
[55/T&R](#) [DS1233MS-3](#) [DS1233MS-3+T&R](#) [DS1233MS-3/T&R](#) [DS1233MS-5+T&R](#) [DS1233MS-55](#) [DS1233MS-](#)
[55+T&R](#) [DS1233MS-55/T&R](#)