

Transil™ TVS for IEC 61000-4-5 compliance

Datasheet - production data

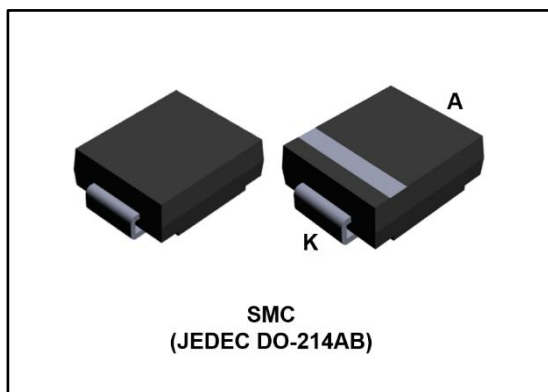

- MIL STD 883G, method 3015-7 Class 3B
 - 25 kV HBM (human body model)
- Resin meets UL 94, V0
- MIL-STD-750, method 2026 solderability
- EIA-481 and IEC 60286-3 packing
- IPC 7531 footprint

Description

The STIEC45 Transil series has been designed to protect DC power supply lines according to IEC 61000-4-5. This device protects circuits against electrical fast transients (EFT) according to IEC 61000-4-4 and ETS EN 300 386.

Protection against electrostatic discharges is provided according to IEC 61000-4-2 and MIL STD 883 Method 3015.

Planar technology makes these devices suitable for high-end equipment and SMPS where low leakage current and high junction temperature are required to provide reliability and stability over time.

The STIEC45 device is packaged in SMC (SMC footprint in accordance with IPC 7351 standard).

Transil is a trademark of STMicroelectronics

Features

- Peak pulse current: 500 A (1.2/50 μ s, 8/20 μ s)
- Stand-off voltage range: from 24 V to 33 V
- Unidirectional types: STIEC45-xxAS
 - Reverse: Clamping starts at V_{BR}
 - Forward: Clamping starts around 0.6 V
- Bidirectional types: STIEC45-xxACS
 - Clamping starts at V_{BR} on both directions
- Low leakage current
 - 0.2 μ A at 25 °C
 - 1 μ A at 85 °C
- Operating T_j max: 150 °C
- High peak current capability at T_j max: 410 A, 8/20 μ s
- JEDEC registered package outline
- RoHS2 compliant

Complies with the following standards

- IEC 61000-4-2 level 4
 - 15 kV (air discharge)
 - 8 kV (contact discharge)
- IEC 61000-4-5
 - Level 4: 4 kV with $R = 12 \Omega$ (334 A) common mode
 - Level 2: 1 kV with $R = 2 \Omega$ (500 A) differential mode

Table 1: Device summary

Order codes unidirectional	V_{RM} (V)	Order codes bidirectional
STIEC45-24AS	24	STIEC45-24ACS
STIEC45-26AS	26	STIEC45-26ACS
STIEC45-28AS	28	STIEC45-28ACS
STIEC45-30AS	30	STIEC45-30ACS
STIEC45-33AS	33	STIEC45-33ACS

1 Characteristics

Table 2: Absolute maximum ratings (limiting values at T_{amb} = 25 °C unless otherwise specified)

Symbol	Parameter	Value	Unit
I _{pp}	Peak pulse current (8/20 μs)	T _j initial = T _{amb} 500	A
T _{stg}	Storage temperature range	-65 to +150	°C
T _j	Operating junction temperature range	-55 to +150	°C
T _L	Maximum lead temperature for soldering during 10 s.	260	°C

Table 3: Thermal resistances

Symbol	Parameter	Value	Unit
R _{th(j-l)}	Junction to leads	15	°C/W
R _{th(j-a)}	Junction to ambient on printed circuit on recommended pad layout	90	°C/W

Figure 1: Electrical characteristics (definitions)

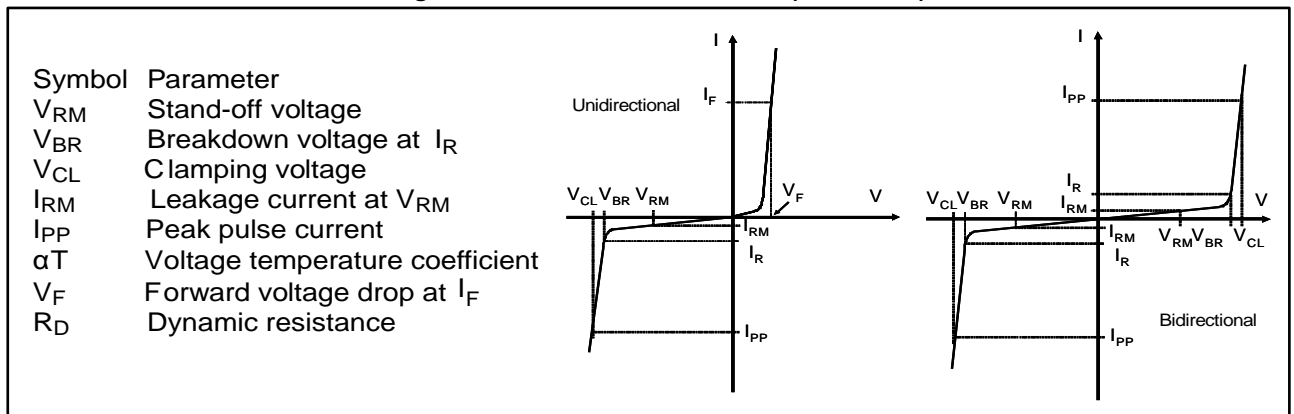

Table 4: Electrical characteristics (T_{amb} = 25 °C)

Order code	I _{RM} at V _{RM}		V _{BR} at I _R ⁽¹⁾				V _{CL} at I _{PP} ⁽²⁾ 1.2/50 μs - 8/20 μs		R _D ⁽³⁾ 8/20 μs	αT ⁽⁴⁾	
	25 °C	85 °C	Min.	Typ.	Max.		Max.		Typ.	Max.	
	μA		V		V		mA	V	A	Ω	10-4/ °C
STIEC45-24AS/ACS	0.2	1	24	26.7	28.2	29.5	1	42	500	0.025	9.6
STIEC45-26AS/ACS	0.2	1	26	28.9	30.3	31.9	1	45	500	0.026	9.7
STIEC45-28AS/ACS	0.2	1	28	31.1	32.6	34.3	1	49	500	0.029	9.8
STIEC45-30AS/ACS	0.2	1	30	33.3	35	36.8	1	55	500	0.036	9.9
STIEC45-33AS/ACS	0.2	1	33	36.7	38.6	40.6	1	59	500	0.036	10

Notes:

- (1)Pulse test : t_p < 50 ms.
- (2)Surge capability given for both directions (unidirectional and bidirectional types).
- (3)To calculate maximum clamping voltage at other surge levels: V_{CLmax} = R_D x I_{PP} + V_{BRmax}
- (4)To calculate V_{BR} versus junction temperature: V_{BR} at T_j = V_{BR} at 25 °C x (1 + αT x (T_j - 25))

1.1 Characteristics (curves)

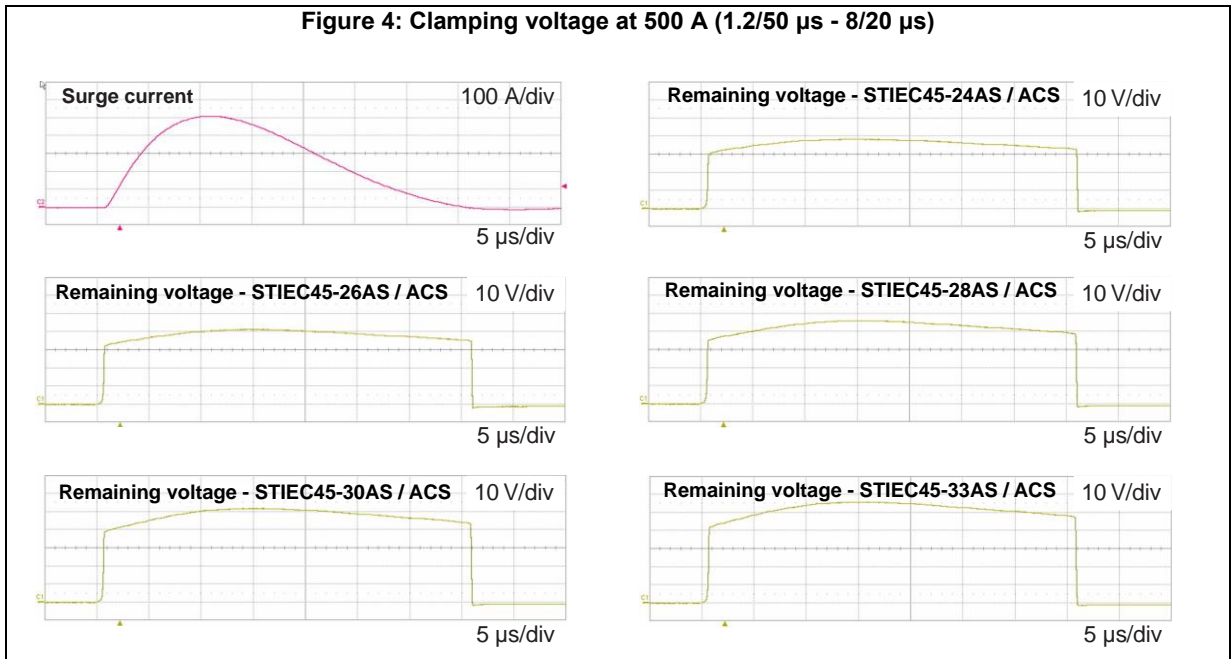
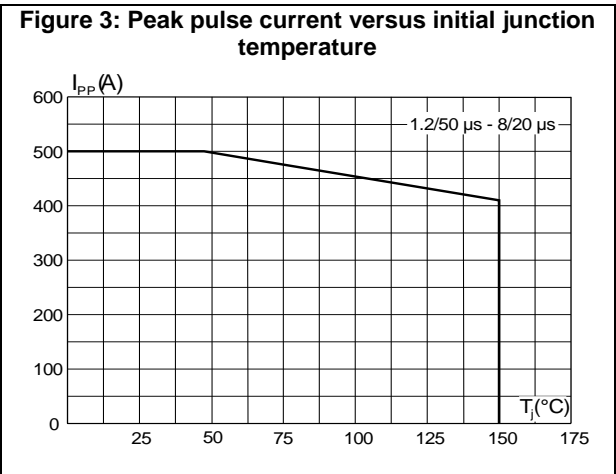
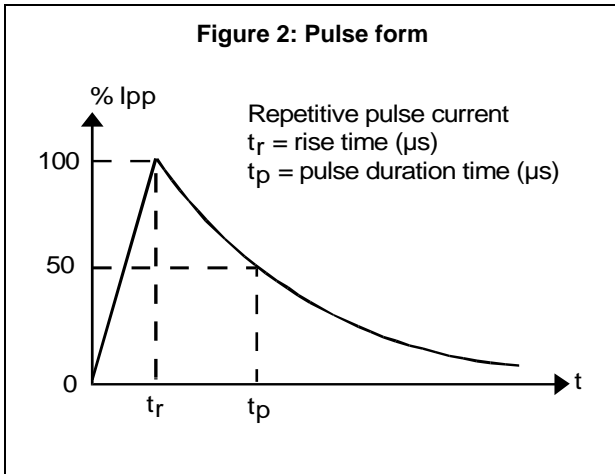

Characteristics

STIEC45-xxAS, STIEC45-xxACS

Figure 5: Junction capacitance versus reverse applied voltage (unidirectional devices)

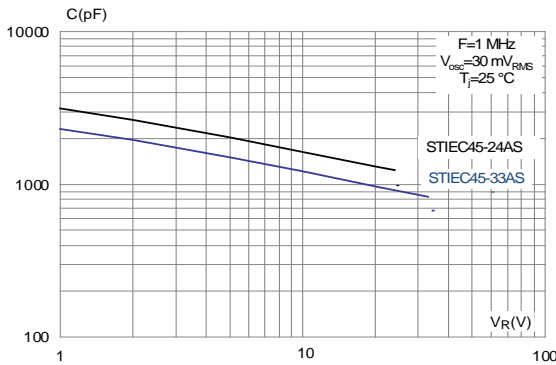

Figure 6: Junction capacitance versus reverse applied voltage (bidirectional devices)

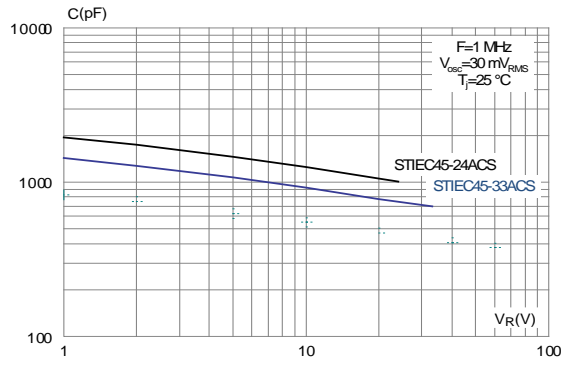

Figure 7: Peak forward voltage drop versus peak forward current (unidirectional devices)

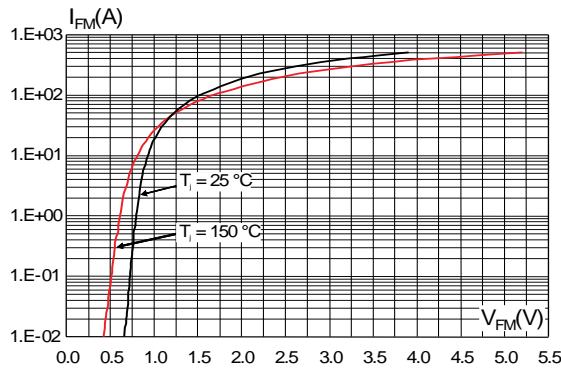

Figure 8: Leakage current versus junction temperature

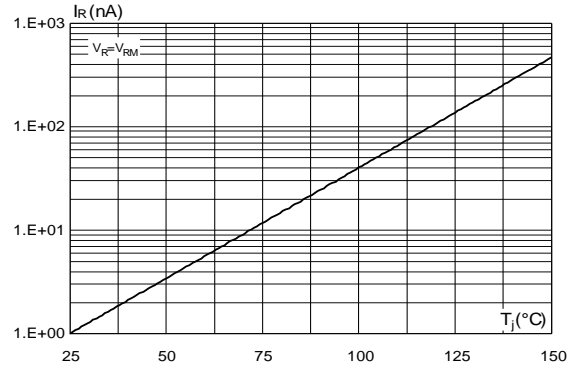

Figure 9: Relative variation of thermal impedance, junction to ambient, versus pulse duration

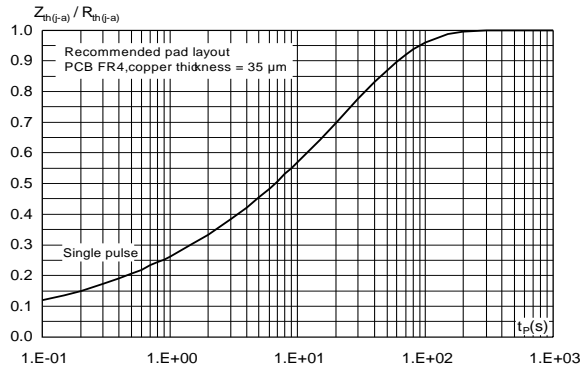
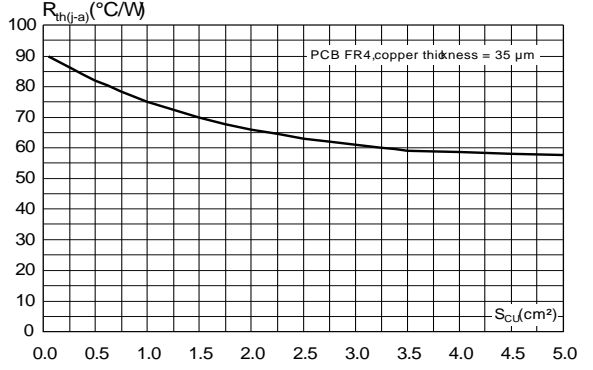

Figure 10: Thermal resistance junction to ambient versus copper surface under each lead



2 Package information

In order to meet environmental requirements, ST offers these devices in different grades of ECOPACK® packages, depending on their level of environmental compliance. ECOPACK® specifications, grade definitions and product status are available at: www.st.com. ECOPACK® is an ST trademark.

2.1 SMC package information

Figure 11: SMC package outline

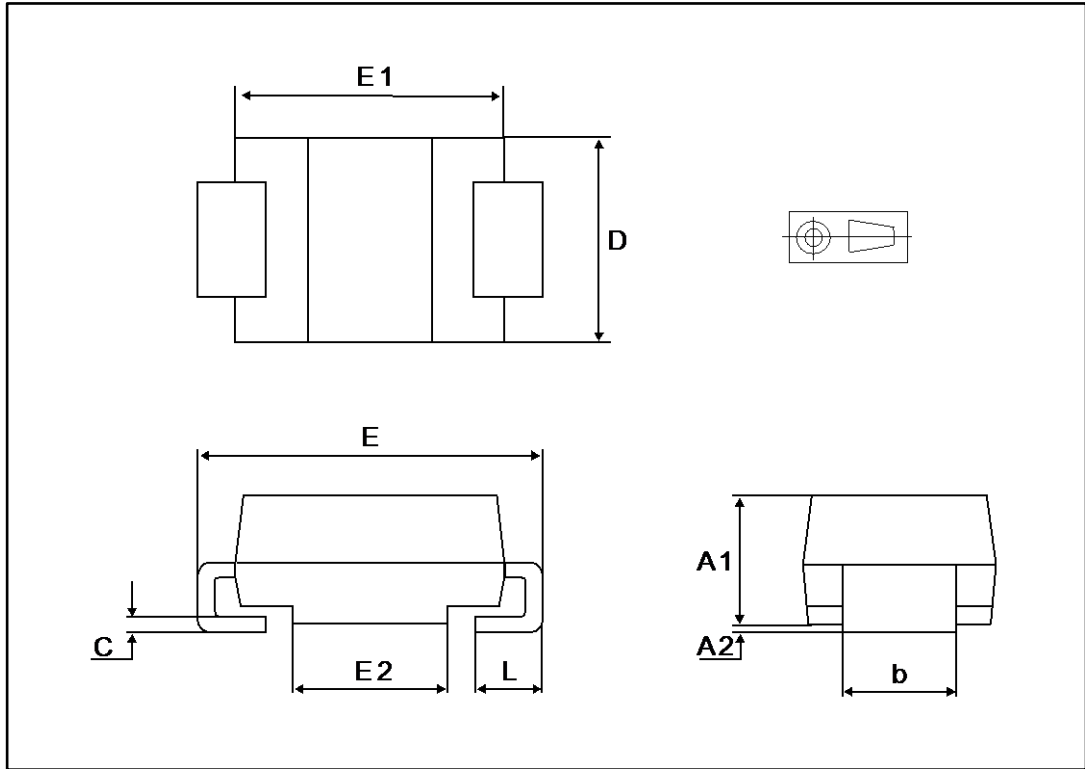
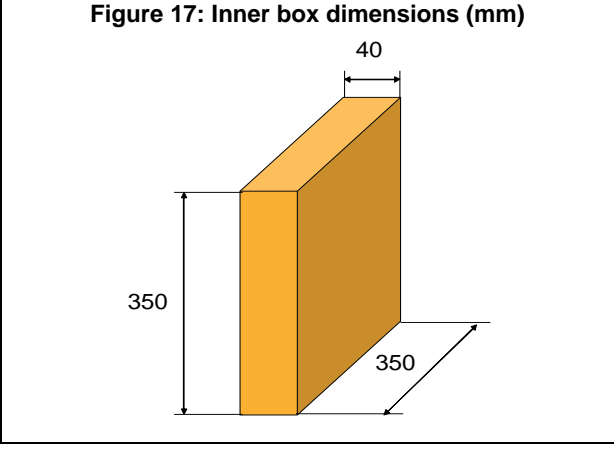
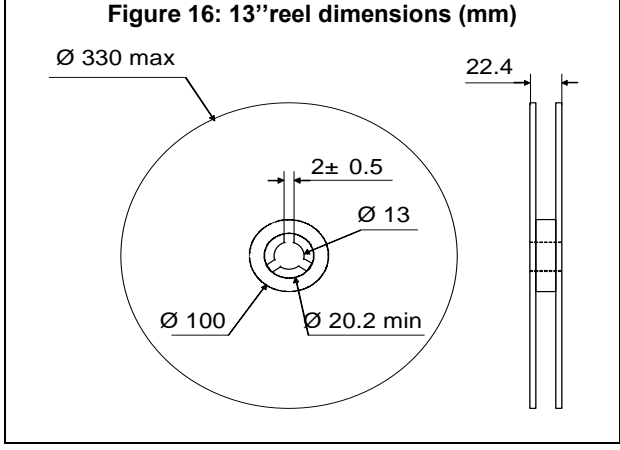
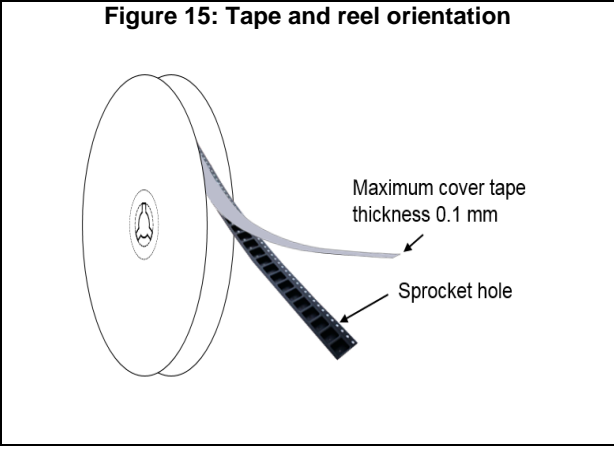
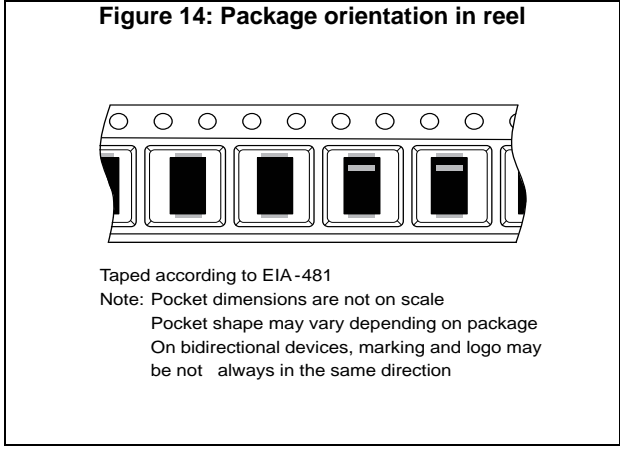
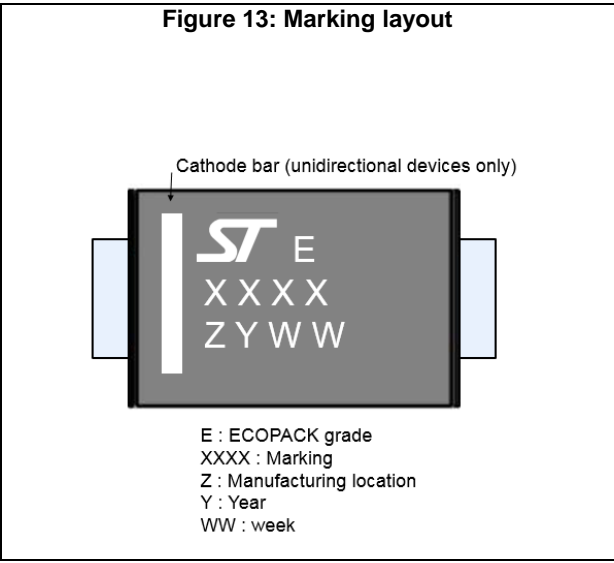
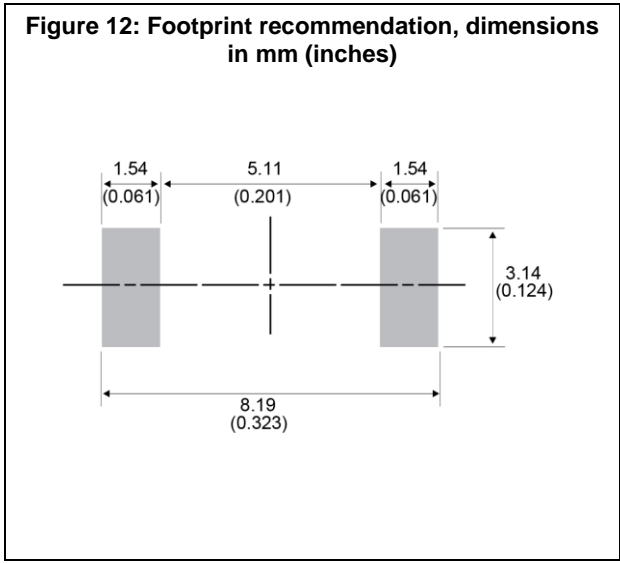

Table 5: SMC package mechanical data

Ref.	Dimensions			
	Millimeters		Inches	
	Min.	Max.	Min.	Max.
A1	1.90	2.45	0.075	0.096
A2	0.05	0.20	0.002	0.008
b	2.90	3.20	0.114	0.126
c	0.15	0.40	0.006	0.016
D	5.55	6.25	0.218	0.246
E	7.75	8.15	0.305	0.321
E1	6.60	7.15	0.260	0.281
E2	4.40	4.70	0.173	0.185
L	0.75	1.50	0.030	0.060



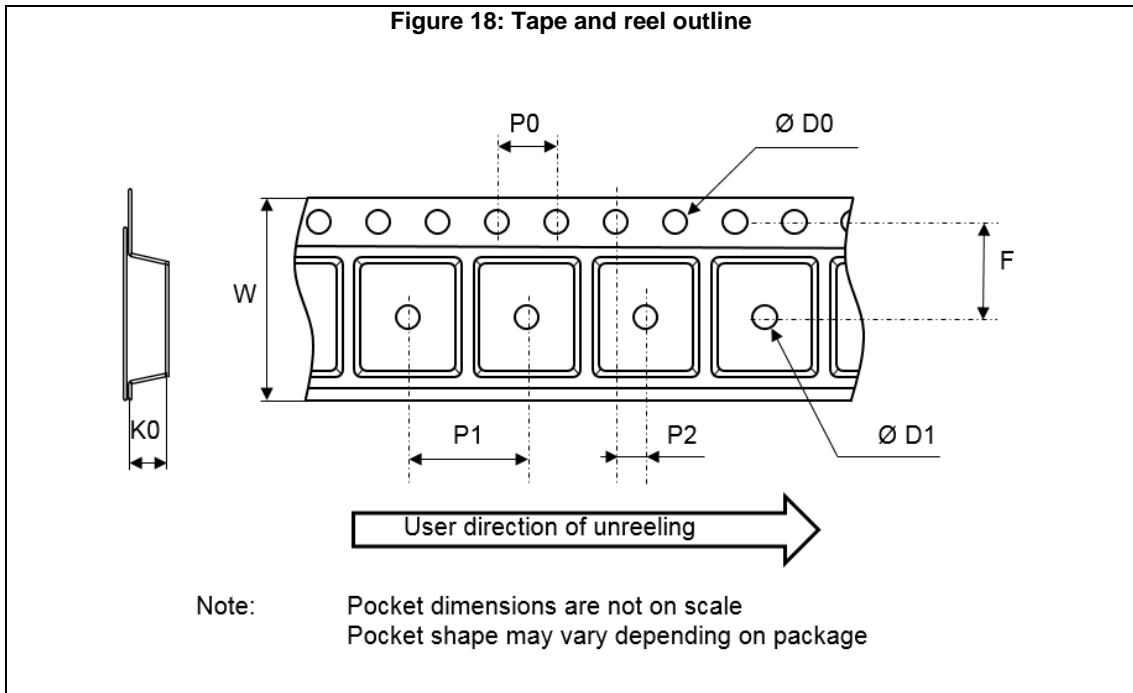
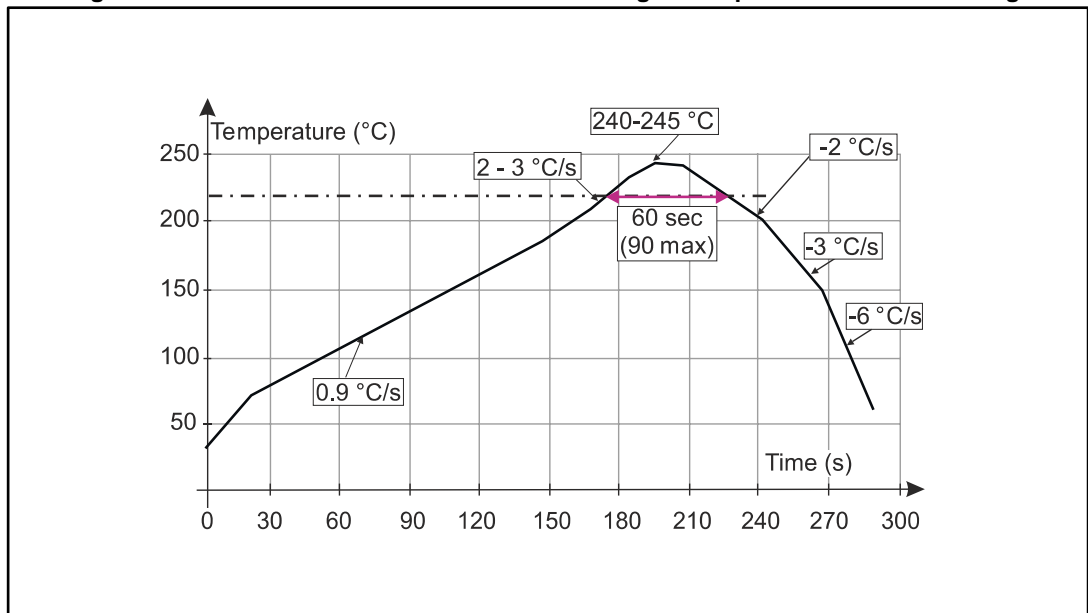

Table 6: Tape and reel mechanical data

Ref.	Dimensions		
	Millimeters		
	Min.	Typ.	Max.
Ø D0	1.4	1.5	1.6
Ø D1	1.5	-	-
F	7.4	7.5	7.6
K0	2.39	2.49	2.59
P0	3.9	4.0	4.1
P1	7.9	8	8.1
P2	1.9	2	2.1
W	15.7	16	16.3

Figure 19: ST ECOPACK® recommended soldering reflow profile for PCB mounting



Minimize air convection currents in the reflow oven to avoid component movement. Maximum soldering profile corresponds to the latest IPC/JEDEC J-STD-020.

3 Ordering information

Figure 20: Ordering information scheme

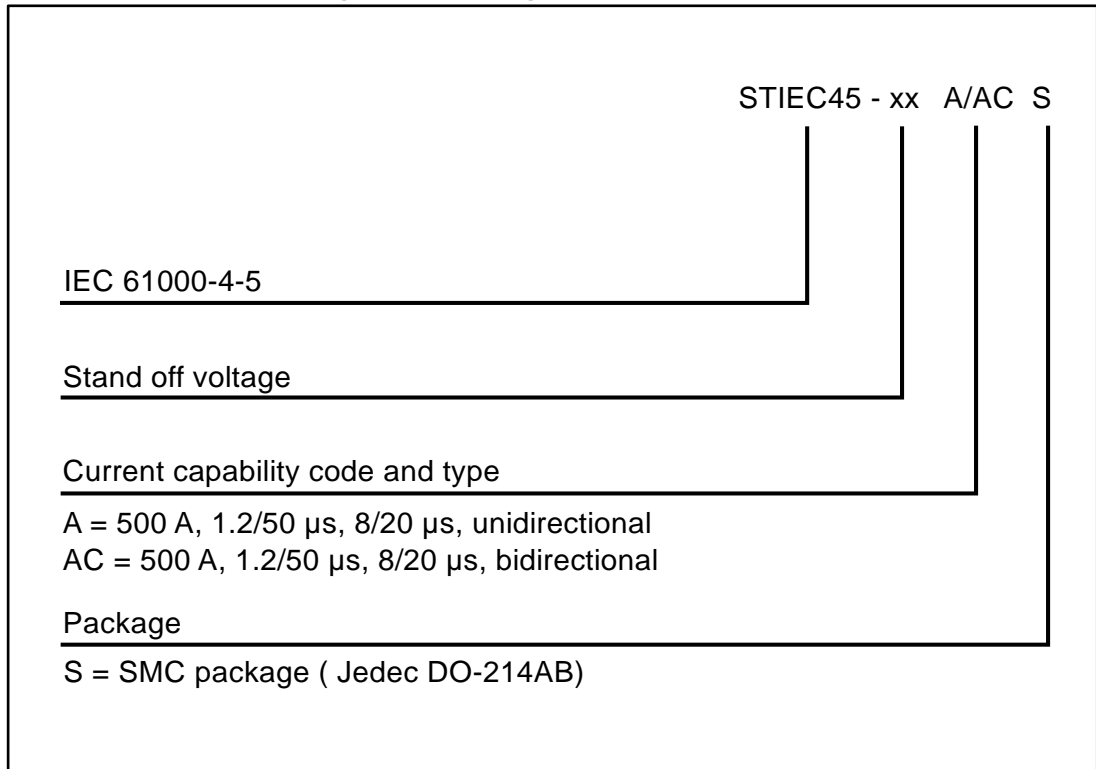

Table 7: Ordering information

Order code	Marking	Package	Weight	Base qty.	Delivery mode
STIEC45-24AS	4524A	SMC	0.25 g	2500	Tape and reel
STIEC45-26AS	4526A				
STIEC45-28AS	4528A				
STIEC45-30AS	4530A				
STIEC45-33AS	4533A				
STIEC45-24ACS	4524C				
STIEC45-26ACS	4526C				
STIEC45-28ACS	4528C				
STIEC4530ACS	4530C				
STIEC45-33ACS	4533C				

4 Revision history

Table 8: Document revision history

Date	Revision	Changes
07-Dec-2017	1	First issue
11-Jan-2017	2	Added bidirectional types and updated stand-off voltage range from 24 V to 68 V.
13-Nov-2017	3	Updated SMC package information. Updated V_{RM} range from 24 V to 33 V.

5 Disclaimer

IMPORTANT NOTICE – PLEASE READ CAREFULLY

STMicroelectronics NV and its subsidiaries ("ST") reserve the right to make changes, corrections, enhancements, modifications, and improvements to ST products and/or to this document at any time without notice. Purchasers should obtain the latest relevant information on ST products before placing orders. ST products are sold pursuant to ST's terms and conditions of sale in place at the time of order acknowledgement.

Purchasers are solely responsible for the choice, selection, and use of ST products and ST assumes no liability for application assistance or the design of Purchasers' products.

No license, express or implied, to any intellectual property right is granted by ST herein.

Resale of ST products with provisions different from the information set forth herein shall void any warranty granted by ST for such product.

ST and the ST logo are trademarks of ST. All other product or service names are the property of their respective owners.

Information in this document supersedes and replaces information previously supplied in any prior versions of this document.

© 2017 STMicroelectronics – All rights reserved

Mouser Electronics

Authorized Distributor

Click to View Pricing, Inventory, Delivery & Lifecycle Information:

STMicroelectronics:

[STIEC45-24AS](#) [STIEC45-30AS](#) [STIEC45-33AS](#) [STIEC45-26AS](#) [STIEC45-27AS](#) [STIEC45-28AS](#) [STIEC45-33ACS](#)
[STIEC45-24ACS](#) [STIEC45-28ACS](#) [STIEC45-26ACS](#) [STIEC45-30ACS](#)