

THIS DRAWING IS UNPUBLISHED. RELEASED FOR PUBLICATION
 © COPYRIGHT BY TYCO ELECTRONICS CORPORATION. ALL RIGHTS RESERVED.

LOC		DIST		REVISIONS			
P	LTR	DESCRIPTION		DATE	DWN	APVD	
CM	00	A	WR-08-39	14AUG2008	KW	CC	

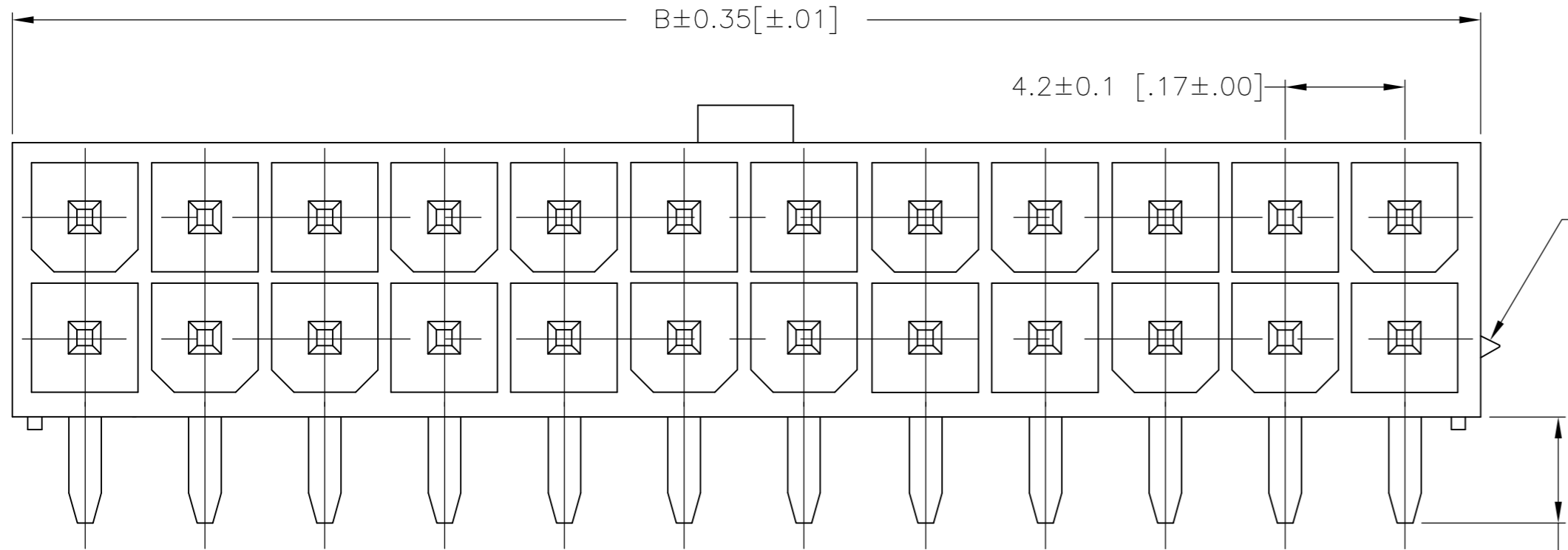

△ MATERIAL: HOUSING: NYLON, UL94V-2, BLUE
 CONTACTS: BRASS, TIN-PLATED

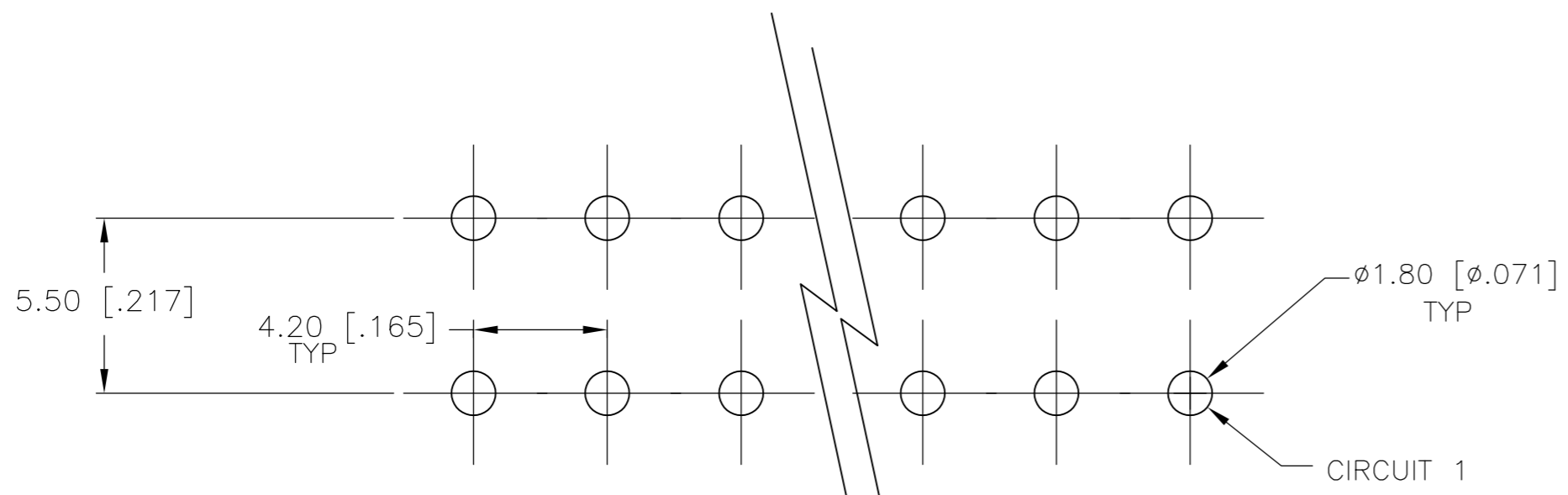
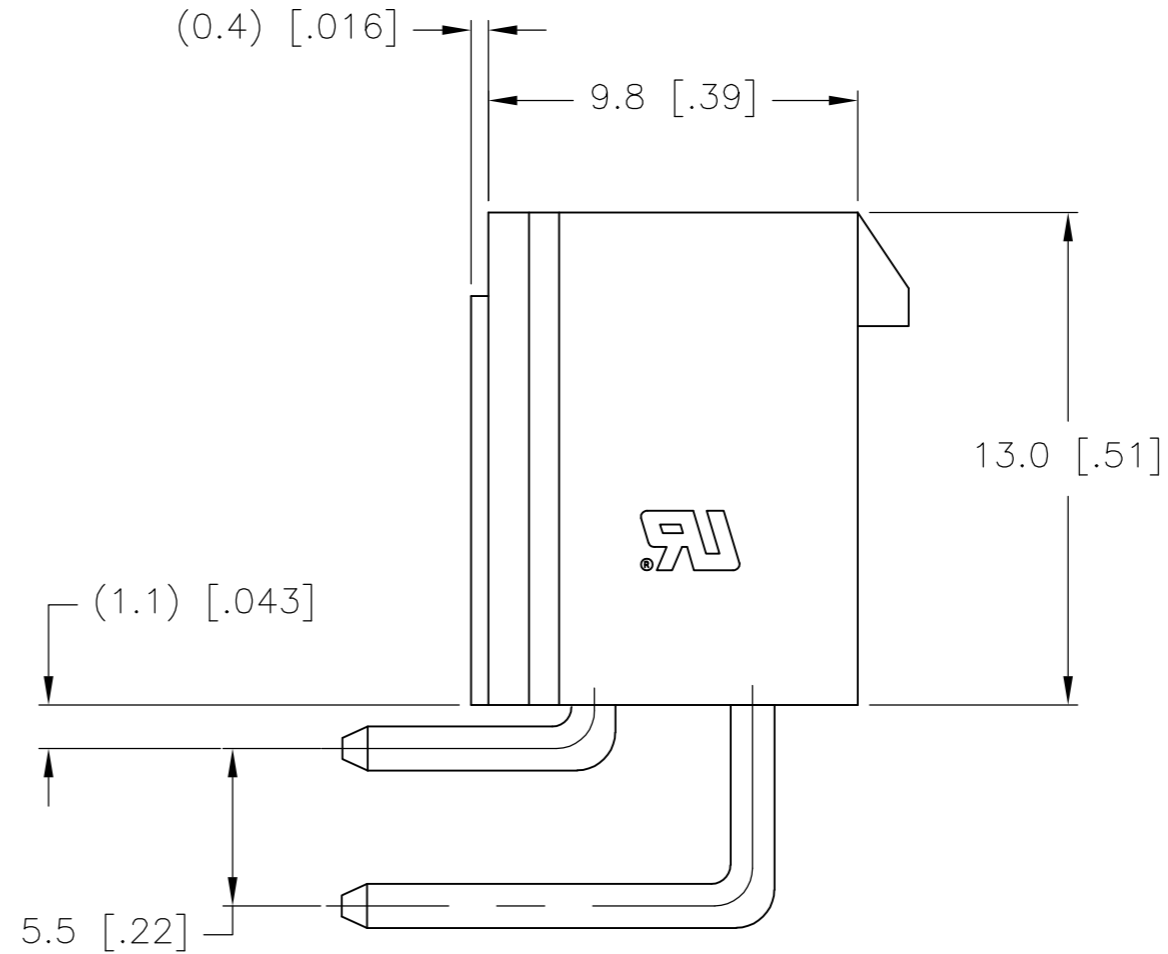
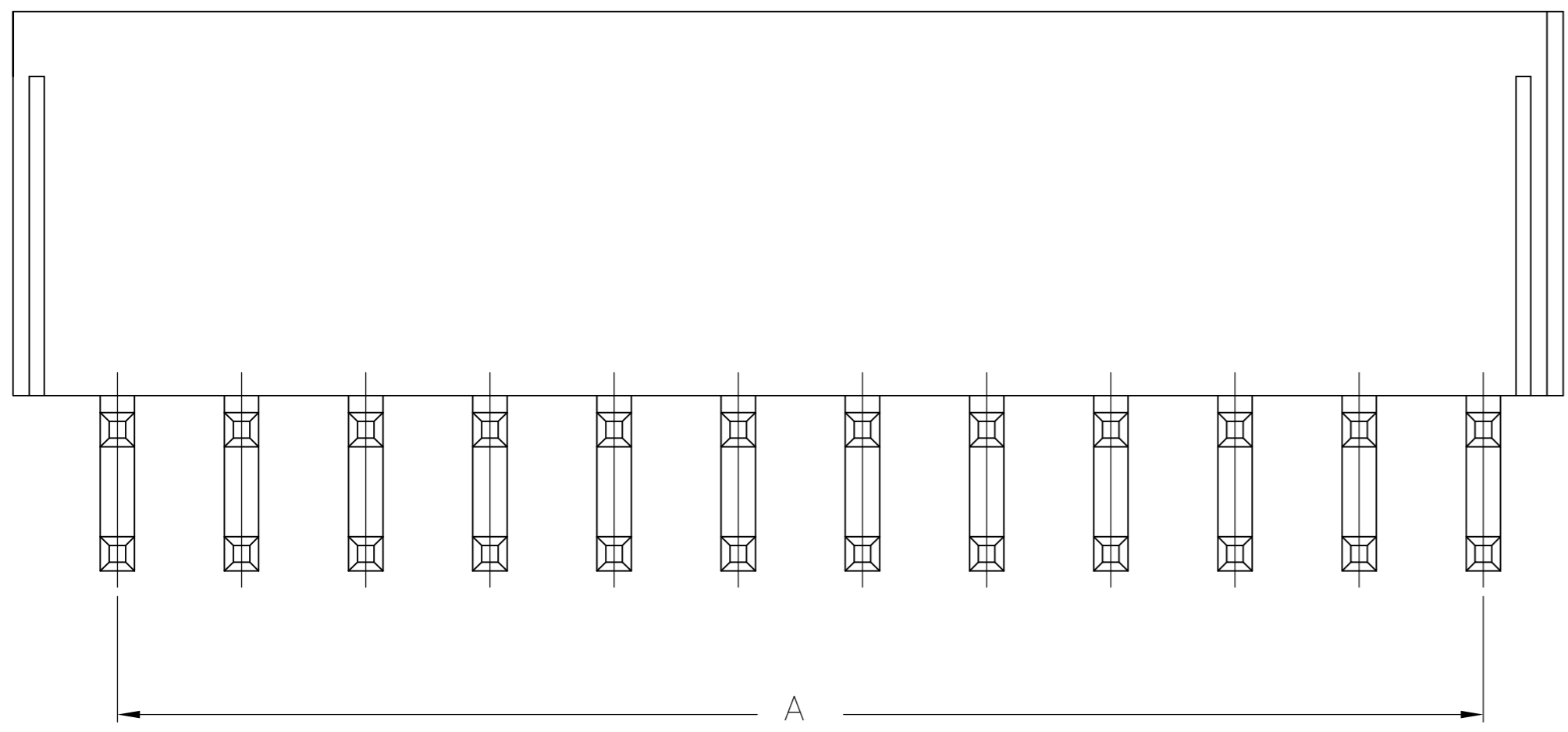

PCB LAYOUT: COMPONENT SIDE
 RECOMMENDED BOARD THICKNESS 1.60 [.063]

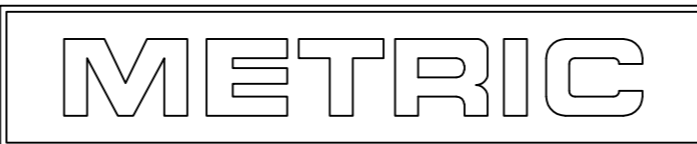

24	46.2±0.2 [1.82±.01]	51.6 [2.03]	2-2029157-4
22	42.0±0.2 [1.65±.01]	47.4 [1.87]	2-2029157-2
20	37.8±0.2 [1.49±.01]	43.2 [1.70]	2-2029157-0
18	33.6±0.2 [1.32±.01]	39.0 [1.54]	1-2029157-8
16	29.4±0.2 [1.16±.01]	34.8 [1.37]	1-2029157-6
14	25.2±0.2 [.99±.01]	30.6 [1.21]	1-2029157-4
12	21.0±0.2 [.83±.01]	26.4 [1.04]	1-2029157-2
10	16.8±0.1 [.66±.00]	22.2 [.87]	1-2029157-0
8	12.6±0.1 [.50±.00]	18.0 [.71]	2029157-8
6	8.4±0.1 [.33±.00]	13.8 [.54]	2029157-6
4	4.2±0.1 [.17±.00]	9.6 [.38]	2029157-4
2	-	5.4 [.21]	2029157-2
POS	A	B±0.35[±.01]	PART NUMBER

2-2029157-4 SHOWN

THIS DRAWING IS A CONTROLLED DOCUMENT.		DWN K. WHITAKER 14AUG2008	Tyco Electronics Corporation Harrisburg, PA 17105-3608	
DIMENSIONS: mm [INCHES]		CHK C. CASH 14AUG2008	NAME RIGHT ANGLE HEADER, BLUE, WITHOUT PEGS; VAL-U-LOK(TM)	
TOLERANCES UNLESS OTHERWISE SPECIFIED: 0 PLC ± 1 PLC ± 2 PLC ± 0.5 [.02] 3 PLC ± 0.25 [.010] 4 PLC ± 0.150 [0059] ANGLES ±		APVD C. CASH 14AUG2008	DRAWING NO A2 00779 C=2029157	
MATERIAL △		FINISH	WEIGHT	RESTRICTED TO -
CUSTOMER DRAWING		SCALE 10:1	SHEET 1 of 1	REV A

Mouser Electronics

Authorized Distributor

Click to View Pricing, Inventory, Delivery & Lifecycle Information:

[TE Connectivity:](#)

[1-2029157-2](#)