

1

2

3

4

5

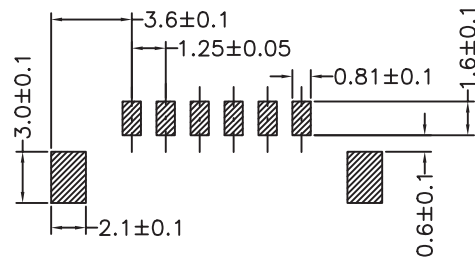
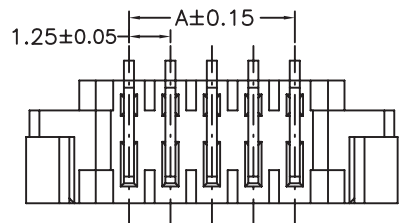

PCB LAYOUT - COMPONENT VIEW

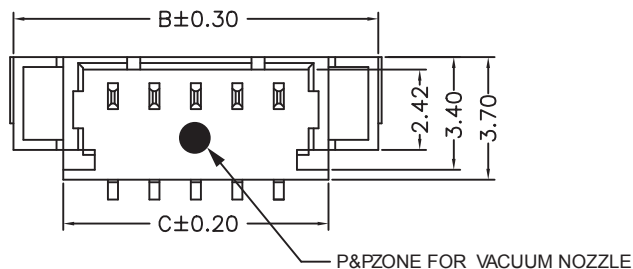
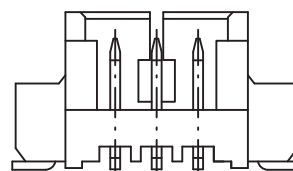
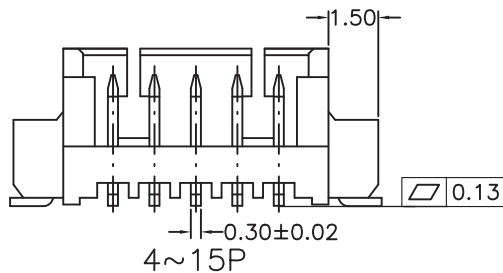
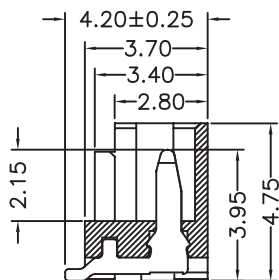

TECHNICAL CHARACTERISTICS

MATERIAL
INSULATOR: NYLON 46
FLAMMABILITY RATING: UL94-V0
COLOR: IVORY
CONTACT MATERIAL: COPPER ALLOY
CONTACT TYPE: STAMPED
CONTACT PLATING: TIN
QUALITY CLASS: 25 MATING CYCLES
PITCH: 1.25 MM

ENVIRONMENTAL
OPERATING TEMPERATURE: -40 UP TO 85°C
COMPLIANCE: LEAD FREE AND ROHS

ELECTRICAL
CURRENT RATING: 1 A
WORKING VOLTAGE: 125 VAC
INSULATOR RESISTANCE: >100 MOHM
DIELECTRIC WITHSTANDING VOLTAGE: 250 VAC/MN
CONTACT RESISTANCE: 20 mOHM MAX

STANDARD
 CERTIFIED: E323964

SOLDERING
JEDEC LEAD FREE REFLOW SOLDERING PROCESS

PACKAGING
TAPE AND REEL

DIMENSION
A = 1.25 x (NB PIN - 1)
B = 1.25 x (NB PIN + 1) + 3.5
C = 1.25 x (NB PIN + 1) + 0.5

RoHS Compliant

PROJECTION:

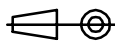

GENERAL TOLERANCE

.X = +/- 0.2

.XX = +/- 0.15



APPROVAL: BBu

UNIT: MM

SCALE:

SHEET: 1/3

DRAW: CEL KING

DESCRIPTION: 1.25 MM SMT MALE VERTICAL SHROUDED HEADER

WERI PART NO: 653 1xx 124 022

SIZE

A4

J	28-FEB-17	TPK	AK
I	14-SEP-16	TPK	AK
H	06-AUG-15	COLOR	AK
REV	DATE	FILE	BY

1

2

3

4

5

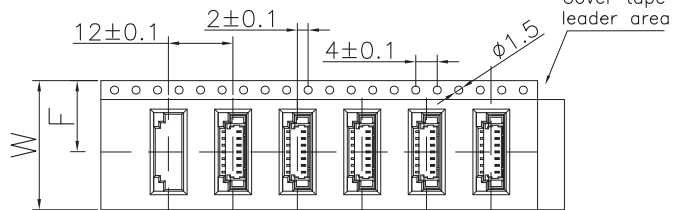
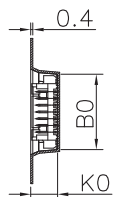
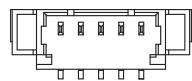

For Reel width (dimension W) 16,24mm
Single row hole

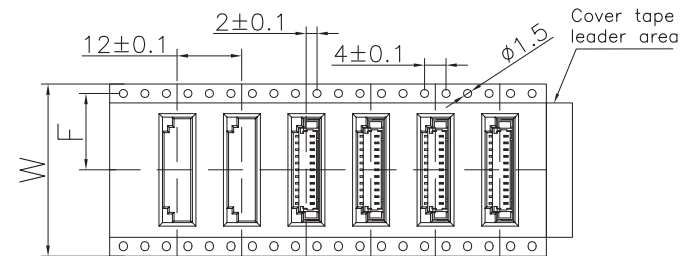
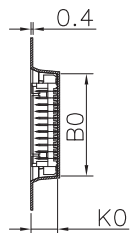

For Reel width (dimension W) 32,44,56,72mm
Double rows hole

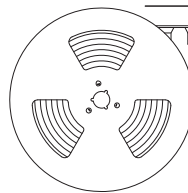
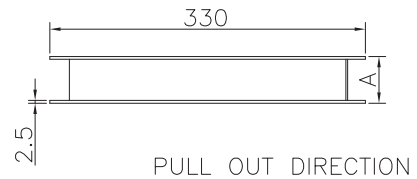

Vacuum Bag

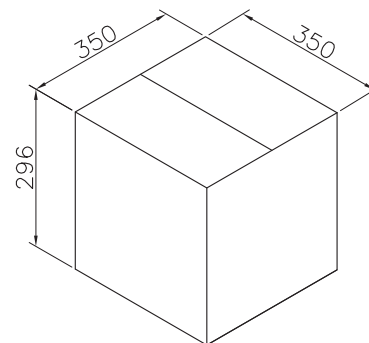
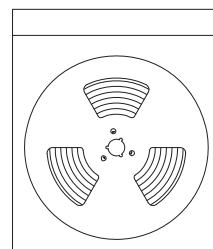

Note:

- 1.All dimensions meet EIA-481-3 requirements.
- 2.Material: Transparent Conductive Polystyrene Alloy 100% recyclable.
- 3.Thickness: 0.40±0.05mm
- 4.Component load per 13" reel:1000 pcs.
- 5.CARTON SIZE:350*350*296(mm)
Vacuum bag:450*500*0.2(mm)

Pin No	W	F	A0	B0	K0	PCS/R	R/CTN	Q'TY
02	24	11.5	4.95	7.75	5.0	1000	9	9000
03	24	11.5	4.95	9.00	5.0	1000	9	9000
04	24	11.5	4.95	10.25	5.0	1000	9	9000
05	24	11.5	4.95	11.50	5.0	1000	9	9000
06	24	11.5	4.95	12.75	5.0	1000	9	9000
07	24	11.5	4.95	14.00	5.0	1000	9	9000
08	24	11.5	4.95	15.25	5.0	1000	9	9000
09	24	11.5	4.95	16.50	5.0	1000	9	9000
10	32	14.2	4.95	17.75	5.0	1000	7	7000
11	32	14.2	4.95	19.00	5.0	1000	7	7000
12	32	14.2	4.95	20.25	5.0	1000	7	7000
13	32	14.2	4.95	21.50	5.0	1000	7	7000
14	44	20.2	4.95	22.75	5.0	1000	5	5000
15	44	20.2	4.95	24.00	5.0	1000	5	5000

RoHS Compliant

PROJECTION:

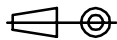

GENERAL TOLERANCE

.X = +/- 0.2

.XX = +/- 0.15



APPROVAL: BBu

UNIT: MM

SCALE:

SHEET: 2/3

DRAW: PEARL

DESCRIPTION: 1.25 MM SMT MALE VERTICAL SHROUDED HEADER

WERI PART NO: 653 1xx 124 022

SIZE

A4

G			
F			
E			
D			
C			
B			
A			
REV	DATE	FILE	BY

A

B

C

D

1

2

3

4

5

Cautions and Warnings:

This electronic component is designed and developed with the intention for use in general electronics equipments.

Before incorporating the components into any equipments in the field such as aerospace, aviation, nuclear control, submarine, transportation, (automotive control, train control, ship control), transportation signal, disaster prevention, medical, public information network etc. where higher safety and reliability are especially required or if there is possibility of direct damage or injury to human body, Würth Elektronik must be asked for a written approval.

In addition, even electronic component in general electronic equipments, when used in electrical circuits that require high safety, reliability functions or performance, the sufficient reliability evaluation-check for the safety must be performed before by the user before usage.

A

B

C

RoHS Compliant

G				PROJECTION: 	GENERAL TOLERANCE .X = +/- 0.2 .XX = +/- 0.15		
F							
E							
D							
C				APPROVAL: JC	UNIT: MM	DESCRIPTION: DISCLAIMER	SIZE A4
B					SCALE:		
A	10-SEP-14	PDF	QL		SHEET: 3/3	WERI PART NO: DISCLAIMER	
REV	DATE	FILE	BY		DRAW: QL		

D

Mouser Electronics

Authorized Distributor

Click to View Pricing, Inventory, Delivery & Lifecycle Information:

[Wurth Electronics:](#)

[653105124022](#) [653104124022](#) [653103124022](#) [653102124022](#)