

THIS DOCUMENT IS THE PROPERTY OF  
KEYSTONE ELECTRONICS CORP. AND  
SHALL NOT BE REPRODUCED, DISTRIBUTED  
OR USED AS A BASIS FOR MANUFACTURE  
WITHOUT PRIOR WRITTEN PERMISSION  
FROM KEYSTONE ELECTRONICS CORP.

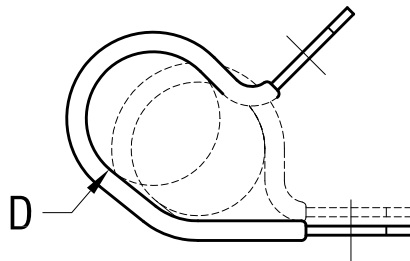
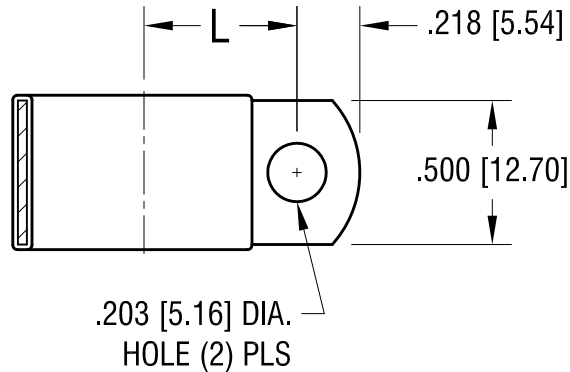

'L' DIM.	'D' FOR DIA.
.687 [17.45]	.750 [19.05]

**KEYSTONE ELECTRONICS CORP.**

www.keyelco.com • ASTORIA, N.Y. 11105-2017 • Tel (718) 956-8900

PART NAME		INSULATED STEEL CABLE CLAMP	
MATERIAL		.032 [.81] TH'K STEEL, BLACK VINYL	
FINISH		DRN BY	DATE
ZINC PLATE CLEAR CHROMATE		BOONE	10.20.99
		APP'D	SCALE
		LN	NONE
TOLERANCES	INCH [MM]	CODE	DWG NO.
DECIMAL	± .010 [± 0.25]	C	8130
ANGULAR	± 1°		
UNLESS OTHERWISE SPECIFIED			

10.18.06	CHANGE AS PER ECN 06-070	A
DATE	DESCRIPTION	REV.

# Mouser Electronics

Authorized Distributor

Click to View Pricing, Inventory, Delivery & Lifecycle Information:

[Keystone Electronics:](#)

[8130](#)