

92x92x25 mm

San Cooler 92 9A type   



General Specifications

- Material Frame: Plastic (Flammability: UL 94V-0), Impeller: Plastic (Flammability: UL 94V-0)
- Expected life See the table below. (L10 life: 90% survival rate for continuous operation in free air at 60°C, rated voltage)
- Motor protection function Locked rotor burnout protection, Reverse polarity protection
For details, please refer to p. 529.
- Dielectric strength 50/60 Hz, 500 VAC, for 1 minute (between lead wire conductors and frame)
- Insulation resistance 10 MΩ or more with a 500 VDC megger (between lead wire conductors and frame)
- Sound pressure level (SPL) At 1 m away from the air inlet
- Storage temperature -30 to +70°C (Non-condensing)
- Lead wire ⊕Red ⊖Black or Blue (Sensor) Yellow
- Mass 100 g

Specifications

The models listed below **have ribs and pulse sensors.** For models without ribs, append "1" to the end of model numbers.

Model no.	Rated voltage [V]	Operating voltage range [V]	Rated current [A]	Rated input [W]	Rated speed [min ⁻¹]	Max. airflow [m ³ /min] [CFM]	Max. static pressure [Pa] [inchH ₂ O]	SPL [dB (A)]	Operating temperature [°C]	Expected life [h]
9A0912G401	12	6 to 13.8	0.39	4.68	3900	1.76 62.1	66.5 0.267	43	-20 to +60	30000/60°C
9A0912S401			0.27	3.24	3550	1.66 58.6	56.1 0.225	39		
9A0912H401			0.21	2.52	3150	1.45 51.2	44 0.177	33		
9A0912F401			0.14	1.68	2650	1.24 43.8	32.2 0.129	30		
9A0912M401			0.12	1.44	2250	1.04 36.7	22.6 0.091	27		
9A0912L401			0.07	0.84	1750	0.8 28.2	13.4 0.054	23		
9A0924G401	24	12 to 27.6	0.19	4.56	3900	1.76 62.1	66.5 0.267	43	-20 to +60	30000/60°C
9A0924S401			0.15	3.6	3550	1.66 58.6	56.1 0.225	39		
9A0924H401			0.1	2.4	3150	1.45 51.2	44 0.177	33		
9A0924F401			0.08	1.92	2650	1.24 43.8	32.2 0.129	30		
9A0924M401			0.05	1.2	2250	1.04 36.7	22.6 0.091	27		
9A0924L401			0.04	0.96	1750	0.8 28.2	13.4 0.054	23		
9A0948S401	48	40.5 to 53	0.08	3.84	3550	1.66 58.6	56.1 0.225	39	-20 to +60	

Other sensor specifications are available as options. Refer to the index (p. 547).

Airflow - Static Pressure Characteristics

9A0912G401 With pulse sensor

Operating voltage range

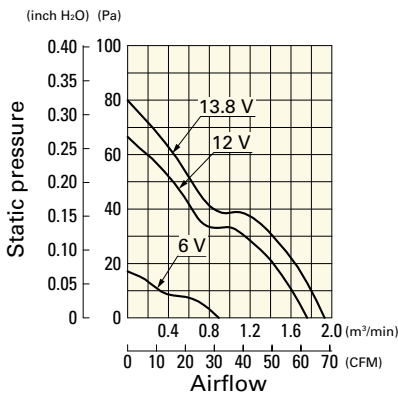

9A0912S401 With pulse sensor

Operating voltage range

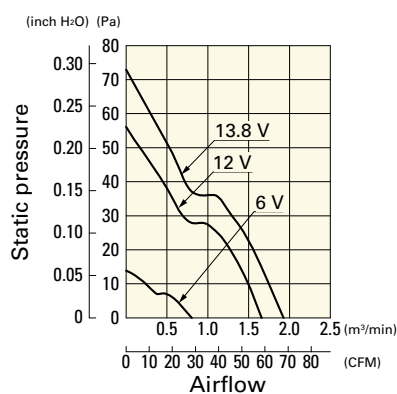

9A0912H401 With pulse sensor

Operating voltage range

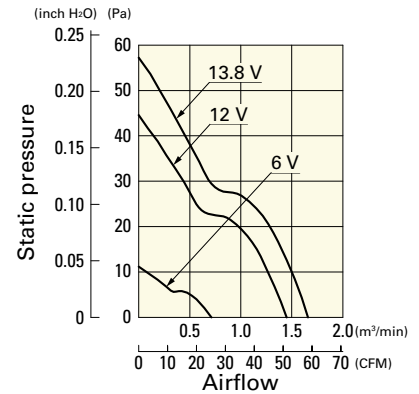

Airflow - Static Pressure Characteristics

9A0912F401 With pulse sensor

Operating voltage range

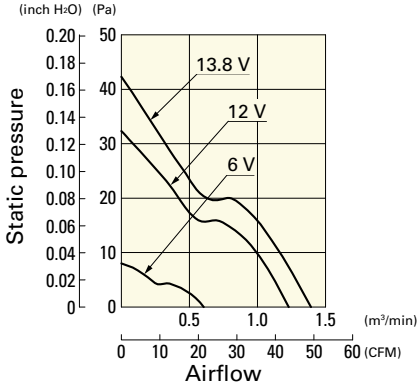

9A0912M401 With pulse sensor

Operating voltage range

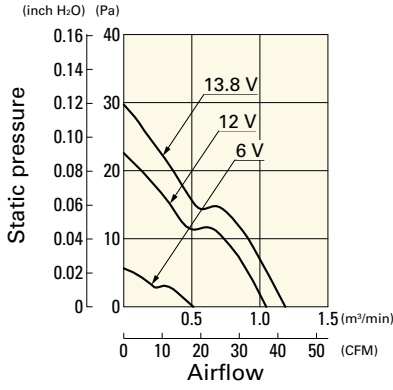

9A0912L401 With pulse sensor

Operating voltage range

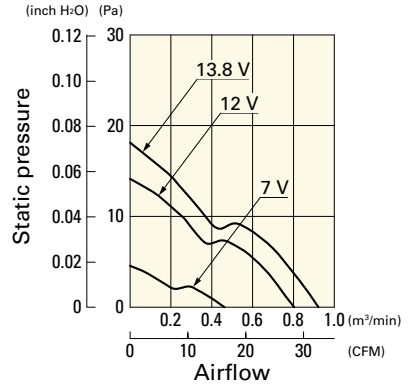

9A0924G401 With pulse sensor

Operating voltage range

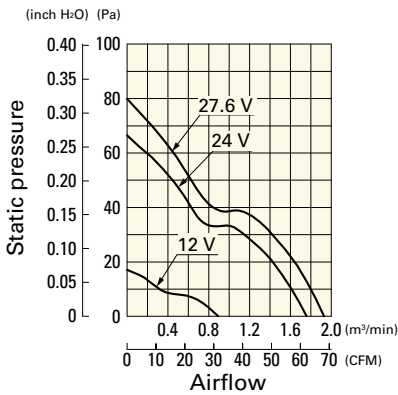

9A0924S401 With pulse sensor

Operating voltage range

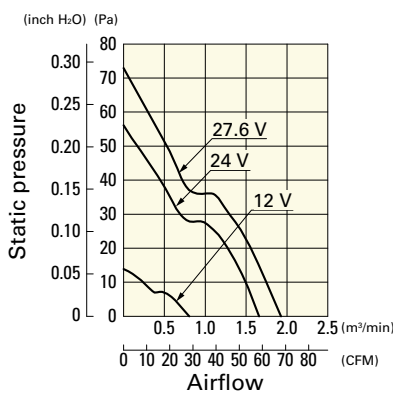

9A0924H401 With pulse sensor

Operating voltage range

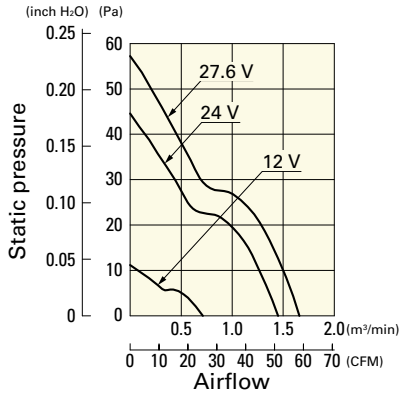

9A0924F401 With pulse sensor

Operating voltage range

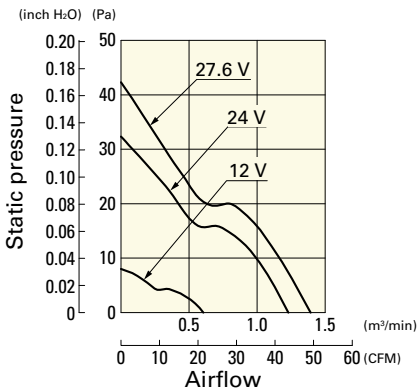

9A0924M401 With pulse sensor

Operating voltage range

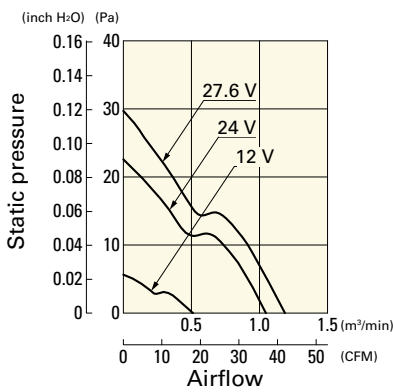

9A0924L401 With pulse sensor

Operating voltage range

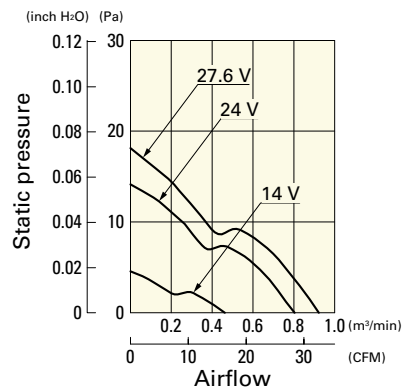

9A0948S401 With pulse sensor

Operating voltage range

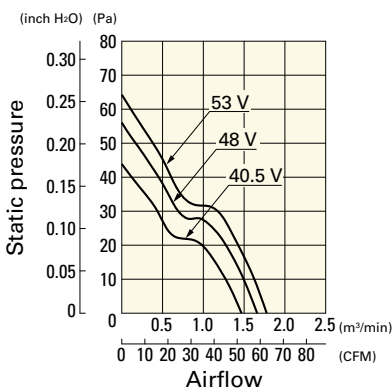

Dimensions (unit: mm) (With ribs)

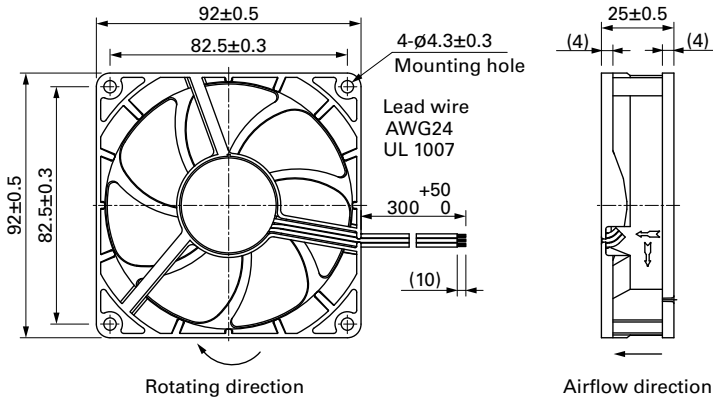

Reference Dimensions of Mounting Holes and Vent Opening (unit: mm)

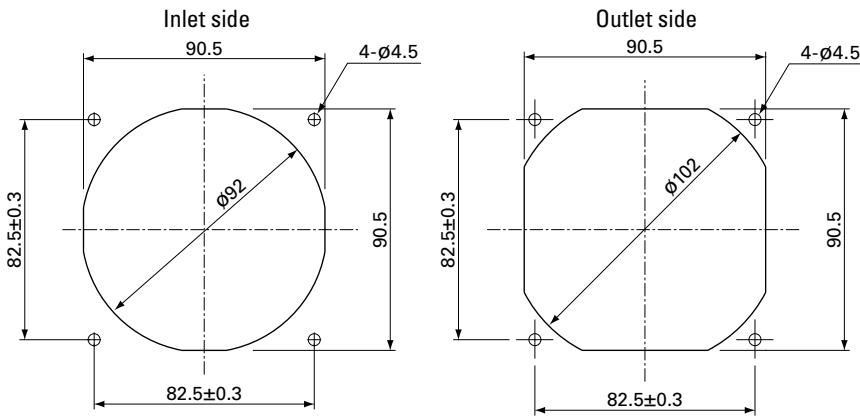

Options

Finger guards

page: p. 513

Model no.: 109-099C, 109-099E, 109-099H

Resin finger guards

page: p. 520

Model no.: 109-1001G

Resin filter kits

page: p. 521

Model no.: 109-1001F13 (13PPI), 109-1001F20 (20PPI),
109-1001F30 (30PPI), 109-1001F40 (40PPI)

Mouser Electronics

Authorized Distributor

Click to View Pricing, Inventory, Delivery & Lifecycle Information:

Sanyo Denki:

[9A0912G402](#) [9A0924S4021](#) [9A0912H401](#) [9A0912H4011](#) [9A0924F4011](#) [9A0924H401](#) [9A0924S401](#)
[9A0924S4011](#) [9AH0912P4G03](#) [9AH0912P4H03](#) [9A0912S4011](#) [9A0912M4011](#) [9A0924H402](#) [9A0924S402](#)
[9A0912S402](#) [9A0912M4021](#) [9A0912G4011](#) [9A0912G4021](#) [9A0912G401](#) [9A0924G401](#) [9A0912S401](#) [9A0924M4011](#)
[9A0924H4011](#) [9A0924M401](#) [9A0912F4011](#) [9A0912M401](#) [9A0924G4011](#) [9A0912L4011](#) [9A0912F401](#)
[9A0924F401](#) [9A0924L401](#) [9A0924L4011](#) [9A0912L401](#) [9A0948S4011](#) [9A0948S401](#) [9A0924L4D01](#) [9A0924G4021](#)
[9A0924M4021](#) [9A0924M4D011](#) [9A0912M4D011](#) [9A0924M4D01](#) [9A0912H402](#) [9A0912H4D011](#) [9A0912L402](#)
[9A0924H4021](#) [9A0912L4D01](#) [9A0912M4D01](#) [9A0912F4021](#) [9A0912H4D01](#) [9A0912S4021](#) [9A0924L402](#)
[9A0924M402](#) [9A0912F402](#) [9A0912H4021](#) [9A0924G4D01](#) [9A0912L4021](#) [9A0912L4D011](#) [9A0912G4D01](#)
[9A0924G402](#) [9A0924F4021](#) [9A0924S4D01](#) [9A0924F4D01](#) [9A0912S4D01](#) [9A0924F4D011](#) [9A0924S4D011](#)
[9A0924H4D011](#) [9A0924L4D011](#) [9A0924H4D01](#) [9A0912F4D01](#) [9A0912G4D011](#) [9A0912F4D011](#) [9A0912M402](#)
[9A0912S4D011](#) [9A0924F402](#) [9A0924L4021](#)