

THIS DRAWING IS UNPUBLISHED. RELEASED FOR PUBLICATION  
 © COPYRIGHT 20 BY TYCO ELECTRONICS CORPORATION. ALL RIGHTS RESERVED.

LOC	DIST	REVISIONS			
P	LTR	DESCRIPTION	DATE	DWN	APVD
C		ECR-09-007434	22APR2009	JS	JH
D		ECR-09-012424	11JUN2009	JS	DB

CERTIFICATION: UL/CUL FILE NO. E102980 HZ. V. A.  
 DIMENSIONS FOR REFERENCE ONLY. 50/60 36

PRIMARY	SECONDARY		P. U. PART NUMBER	TYCO ELECTRONICS PART NUMBER
	SERIES	PARALLEL		
115 VAC	12 VCT	6 VAC	4900-8012RF65	1672327-2
115 VAC	12.6 VCT	6.3 VAC	4900-8013RF65	1672327-3
115 VAC	24 VCT	12 VAC	4900-8024RF65	1672327-6
115 VAC	28 VCT	14 VAC	4900-8028RF65	1672327-7
115 VAC	48 VCT	24 VAC	4900-8048RF65	1-1672327-0
115/230 VAC	12 VCT	6 VAC	4900-9012RF65	1-1672327-4
115/230 VAC	12.6 VCT	6.3 VAC	4900-9013RF65	1-1672327-5
115/230 VAC	24 VCT	12 VAC	4900-9024RF65	1-1672327-8
115/230 VAC	28 VCT	14 VAC	4900-9028RF65	1-1672327-9
115/230 VAC	48 VCT	24 VAC	4900-9048RF65	2-1672327-2

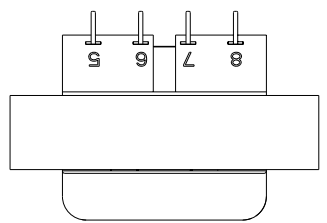
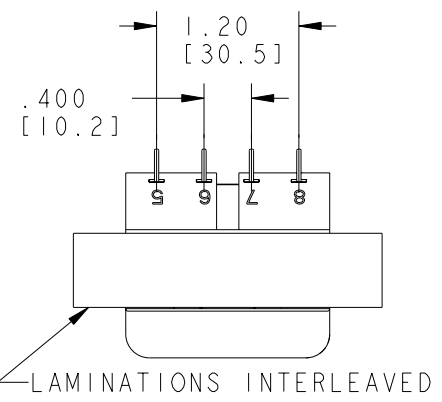
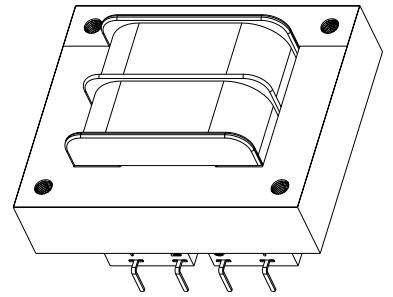
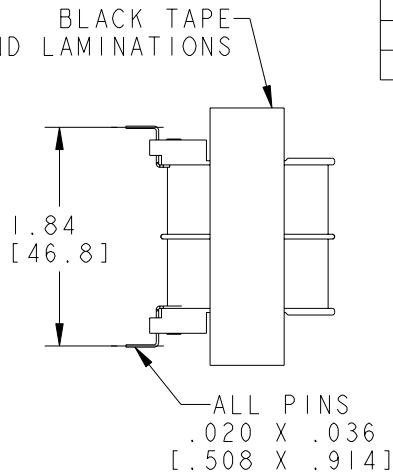
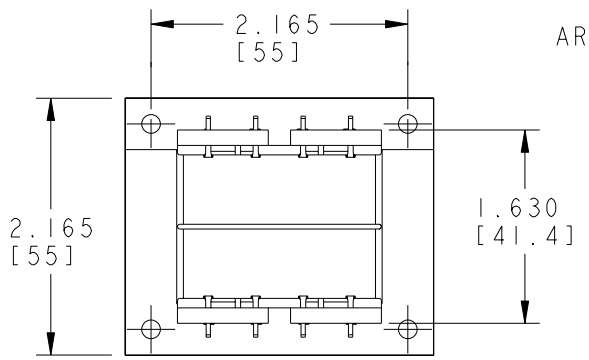
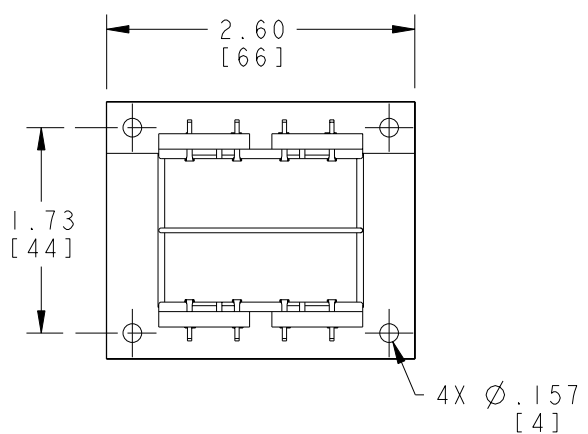
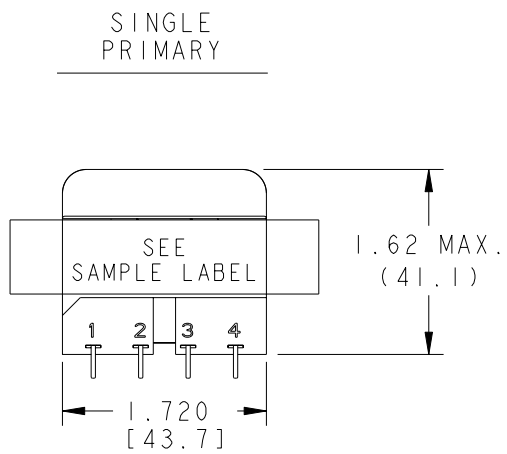
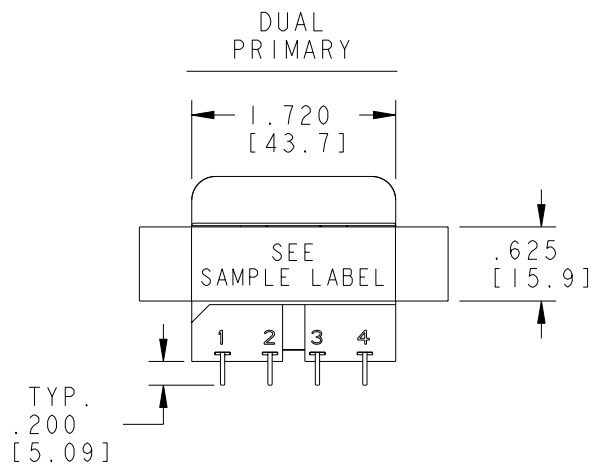

4900-XXXXRF65  
 50/60HZ 36VA SEC-6/12 VAC  
 MADE IN XXXX  
**Tyco Electronics**  
 [115V] [115V]  
 XXX (DATE CODE)

SAMPLE LABEL SCALE: 4:1  
 VOLTAGE ON LABEL WILL VARY PER MODEL NUMBER

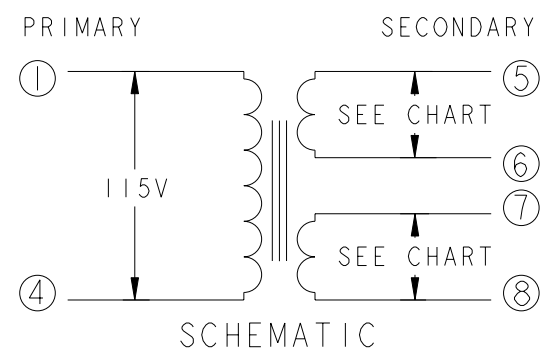
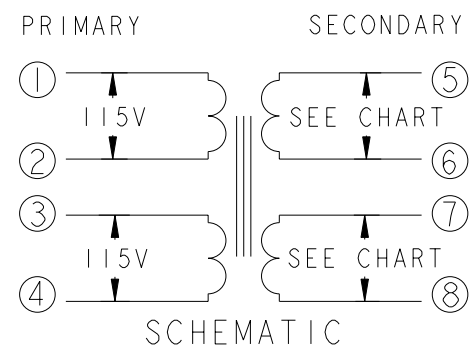

<small>THIS DRAWING IS A CONTROLLED DOCUMENT FOR TYCO ELECTRONICS CORPORATION IT IS SUBJECT TO CHANGE AND THE CONTROLLING ENGINEERING ORGANIZATION SHOULD BE CONTACTED FOR THE LATEST REVISION.</small>		DWN J. SLIKE 22APR2009 CHK J. HURLBURY 22APR2009 APVD J. HURLBURY 22APR2009	<b>Tyco Electronics</b> Tyco Electronics Harrisburg, PA 17105-3608
DIMENSIONS: INCHES [mm]	TOLERANCES UNLESS OTHERWISE SPECIFIED: 0 PLC ± 1 PLC ± 2 PLC ±.01 3 PLC ±.005 4 PLC ± ANGLES ± FINISH	NAME TRANSFORMER OUTLINE APPLICATION SPEC PRODUCT SPEC	SIZE A2 CAGE CODE 00779 DRAWING NO. 4900-RF65 RESTRICTED TO
MATERIAL		WEIGHT	SCALE 1:1 SHEET 1 OF 1 REV D
CUSTOMER DRAWING			

# Mouser Electronics

Authorized Distributor

Click to View Pricing, Inventory, Delivery & Lifecycle Information:

[TE Connectivity:](#)

[4900-8024RF65](#)