



60×60×38 mm

San Ace 60 9GV type

General Specifications

- Material Frame: Plastic (Flammability: UL 94V-0), Impeller: Plastic (Flammability: UL 94V-1)
- Expected life See the table below. (L10 life: 90% survival rate for continuous operation in free air at 60°C, rated voltage)
- Motor protection function Locked rotor burnout protection, Reverse polarity protection
For details, please refer to p. 529.
- Dielectric strength 50/60 Hz, 500 VAC, for 1 minute (between lead wire conductors and frame)
- Insulation resistance 10 MΩ or more with a 500 VDC megger (between lead wire conductors and frame)
- Sound pressure level (SPL) At 1 m away from the air inlet
- Storage temperature -30 to +70°C (Non-condensing)
- Lead wire ⊕Red ⊖Black (Sensor) Yellow (Control) Brown
- Mass 130 g

Specifications

The models listed below **have ribs and pulse sensors with PWM control function.** For models without ribs, append "1" to the end of model numbers.

Model no.	Rated voltage [V]	Operating voltage range [V]	PWM duty cycle* [%]	Rated current [A]	Rated input [W]	Rated speed [min ⁻¹]	Max. airflow [m ³ /min] [CFM]	Max. static pressure [Pa] [inchH ₂ O]	SPL [dB (A)]	Operating temperature [°C]	Expected life [h]
9GV0612P1G03	12	8.0 to 13.8	100	2.8	33.6	16000	2.37 84	751 3.02	66	-20 to +70	40000/60°C
			0	0.12	1.5	3100	0.44 15	26 0.1	25		
9GV0612P1H03			100	2.0	24.0	14500	2.15 76	617 2.48	63		
			0	0.1	1.2	2700	0.4 14	21 0.09	22		
9GV0612P1M03		10.8 to 13.8	100	1.5	18.0	13000	1.93 68	496 1.99	60		
			0	0.08	1.0	2500	0.38 13	18 0.07	19		
9GV0612P1L01**			100	0.7	8.4	10000	1.49 52.6	293 1.17	52		
9GV0624P1G03	24	20.4 to 27.6	100	1.4	33.6	16000	2.37 84	751 3.02	66		
			0	0.12	2.88	6000	0.89 31	105 0.42	38		
9GV0624P1M03**			100	0.73	17.52	13000	1.93 68.0	496 1.99	60		
			0	0.5	24	14500	2.15 76	617 2.48	63		
9GV0648P1H03		38 to 57	100	0.5	24	14500	2.15 76	617 2.48	63		
			0	0.08	3.84	6000	0.89 31	105 0.42	38		

* PWM frequency: 25 kHz ** Fan does not rotate when PWM duty cycle is 0%.

Other sensor specifications are available as options. Refer to the index (p. 554).

Airflow - Static Pressure Characteristics / PWM Duty - Speed Characteristics Example

9GV0612P1G03 With pulse sensor with PWM control function

PWM duty cycle

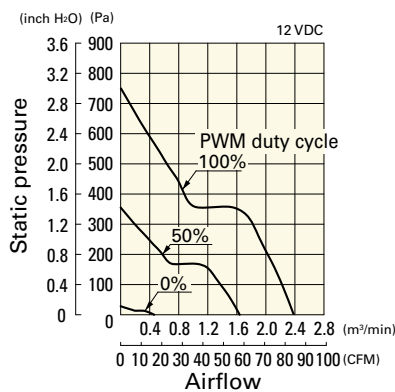

Operating voltage range

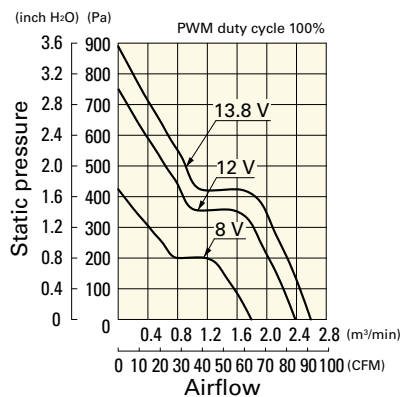

PWM duty - Speed characteristics example

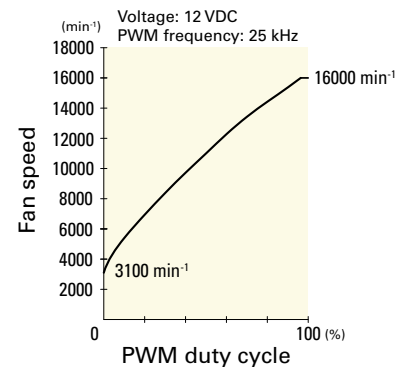

Airflow - Static Pressure Characteristics / PWM Duty - Speed Characteristics Example

9GV0612P1H03 With pulse sensor with PWM control function

PWM duty cycle

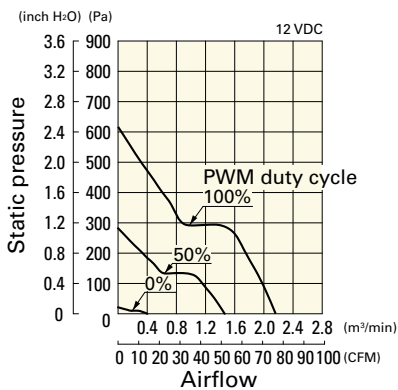

Operating voltage range

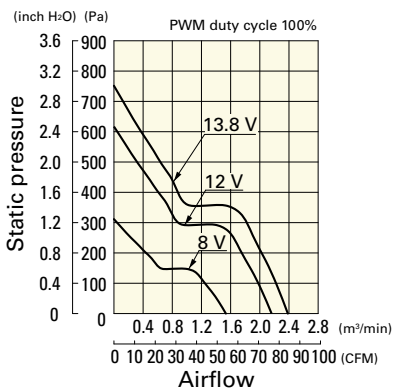

PWM duty - Speed characteristics example

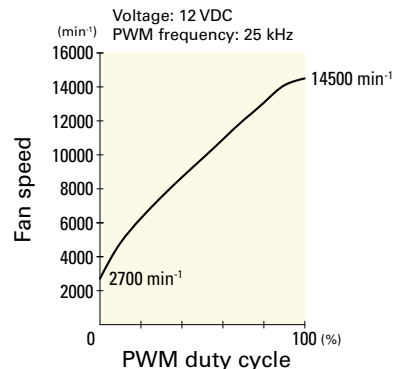

9GV0612P1M03 With pulse sensor with PWM control function

PWM duty cycle

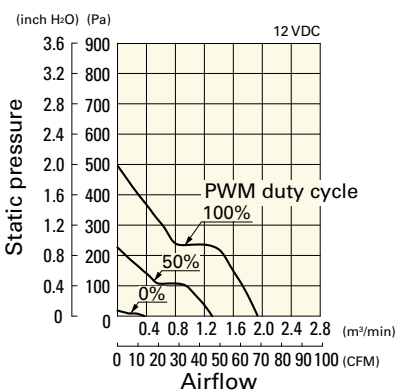

Operating voltage range

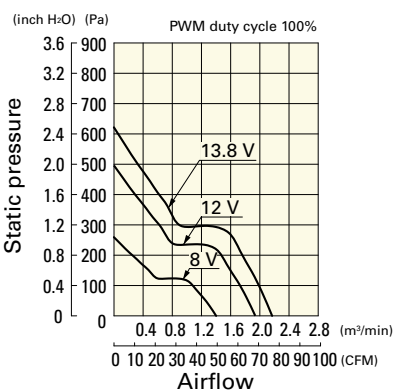

PWM duty - Speed characteristics example

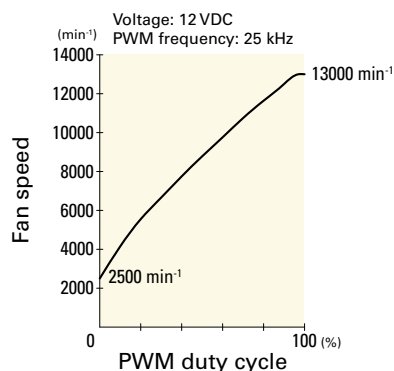

9GV0612P1L01 With pulse sensor with PWM control function

PWM duty cycle

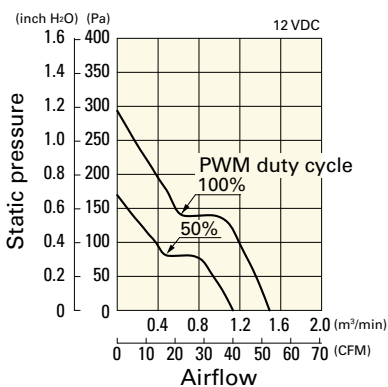

Operating voltage range

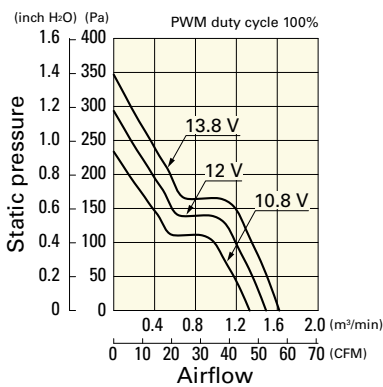

PWM duty - Speed characteristics example

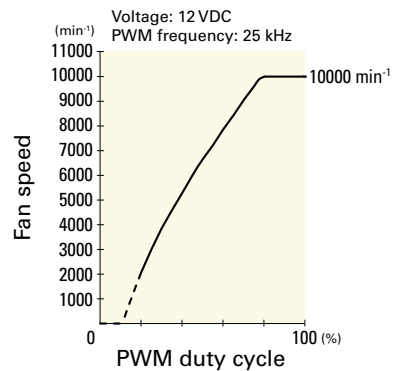

9GV0624P1G03 With pulse sensor with PWM control function

PWM duty cycle

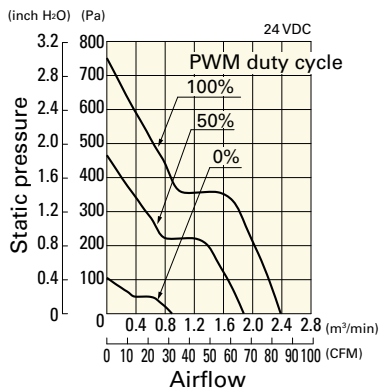

Operating voltage range

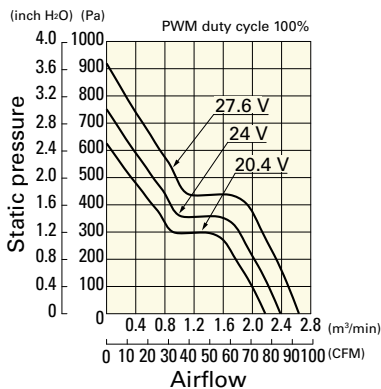

PWM duty - Speed characteristics example

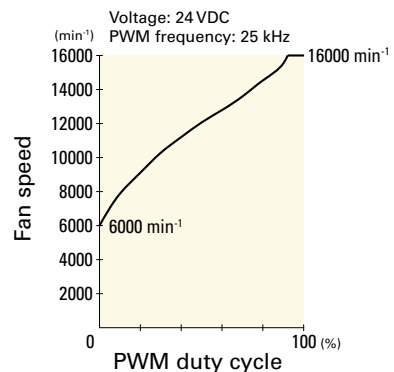

Airflow - Static Pressure Characteristics / PWM Duty - Speed Characteristics Example

9GV0624P1M03 With pulse sensor with PWM control function

PWM duty cycle

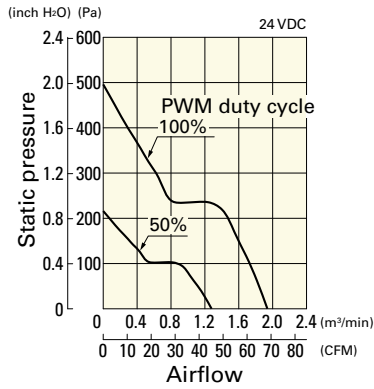

Operating voltage range

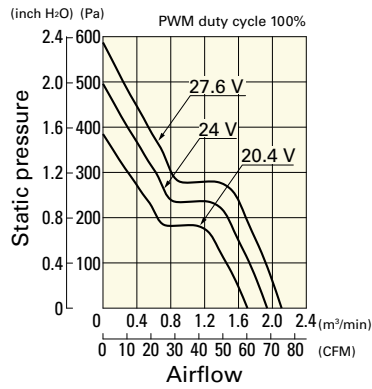

PWM duty - Speed characteristics example

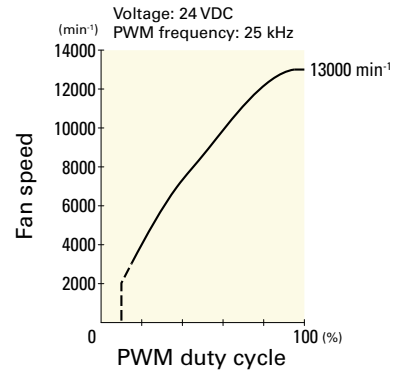

9GV0648P1H03 With pulse sensor with PWM control function

PWM duty cycle

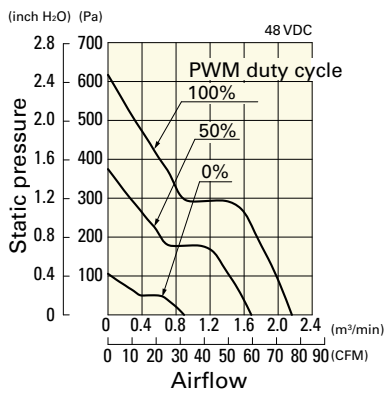

Operating voltage range

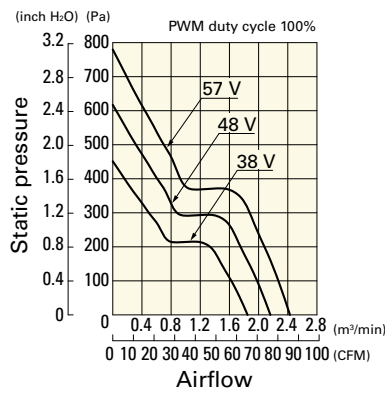

PWM duty - Speed characteristics example

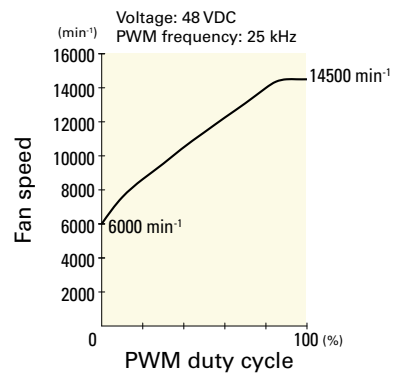

Dimensions (unit: mm) (With ribs)

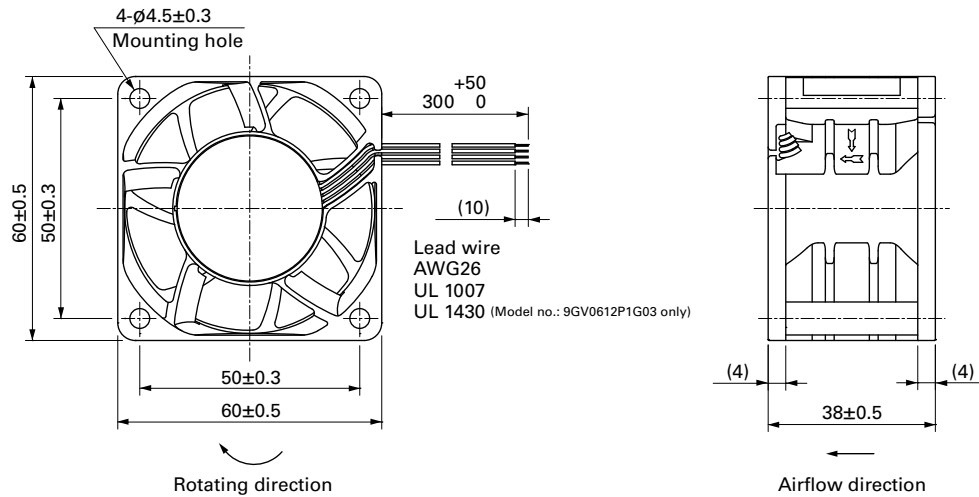

■ Reference Dimensions of Mounting Holes and Vent Opening (unit: mm)

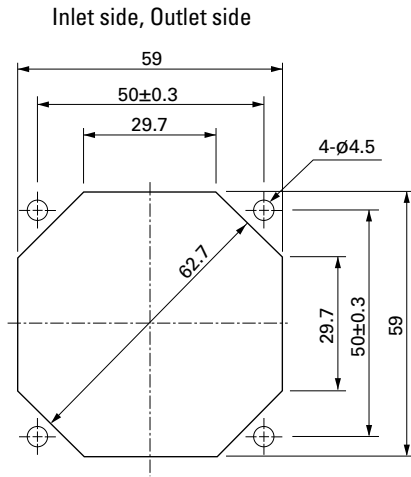

■ Options

Finger guards

page: p. 513

Model no.: 109-139E, 109-139H

Resin finger guards

page: p. 520

Model no.: 109-1003G

Resin filter kits

page: p. 521

Model no.: 109-1003F13 (13PPI), 109-1003F20 (20PPI),
109-1003F30 (30PPI), 109-1003F40 (40PPI)

Mouser Electronics

Authorized Distributor

Click to View Pricing, Inventory, Delivery & Lifecycle Information:

Sanyo Denki:

[9GV0612P1H031](#) [9GV0612P1M03](#) [9GV0624P1G03](#) [9GV0612P1G031](#) [9GV0612P1G03](#) [9GV0624P1G031](#)
[9GV0612P1M031](#) [9GV0612P1H03](#) [9GV0612G1D011](#) [9GV0612M1D011](#) [9GV0612G102](#) [9GV0612H1D01](#)
[9GV0612M1D01](#) [9GV0612G1021](#) [9GV0612M102](#) [9GV0612H101](#) [9GV0612H1D011](#) [9GV0612M101](#) [9GV0612H102](#)
[9GV0624G1D01](#) [9GV0624G101](#) [9GV0612G101](#) [9GV0624G102](#) [9GV0612H1021](#) [9GV0612H1011](#) [9GV0612G1011](#)
[9GV0612G1D01](#) [9GV0624P1M03](#) [9GV0624G1021](#) [9GV0612P1L01](#) [9GV0612L1011](#) [9GV0624M101](#) [9GV0624M102](#)