

DO NOT SCALE FROM THIS PRINT

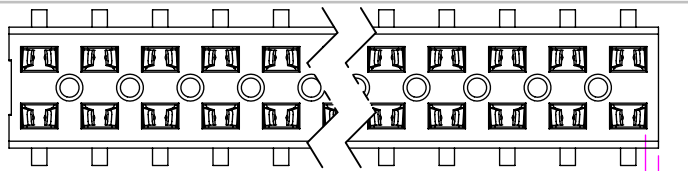

FIG 6
-BE OPTION (SEE NOTE 11)
(SAME AS FIG 1 EXCEPT INSULATOR)

PATENT NUMBERS
5713755
5961339

CLT-1XX-02-XX-D-XX

No OF POS. PER ROW
-02 THRU -50

LEAD STYLE
-02: SURFACE MOUNT (SEE TABLE 1)

PLATING SPECIFICATION

- F: 3µ" SELECTIVE GOLD IN CONTACT AREA, MATTE TIN ON TAIL
- L: 10µ" SELECTIVE GOLD IN CONTACT AREA, MATTE TIN ON TAIL
- G: 10µ" GOLD IN CONTACT AREA, 3µ" GOLD ON TAIL
- S: 30µ" SELECTIVE GOLD IN CONTACT AREA, MATTE TIN ON TAIL
- H: 30µ" GOLD IN CONTACT AREA, 3µ" GOLD ON TAIL
- FM: 3µ" SELECTIVE GOLD IN CONTACT AREA, MATTE TIN ON TAIL
- LM: 10µ" SELECTIVE GOLD IN CONTACT AREA, MATTE TIN ON TAIL
- SM: 30µ" SELECTIVE GOLD IN CONTACT AREA, MATTE TIN ON TAIL

OPTION

- P: PICK & PLACE PAD AVAILABLE ON POSITIONS 04 THRU 50 ONLY (SEE FIG. 2, SHT 2. USE LMP-03)
- TR: TAPE AND REEL PACKAGING (02 THRU 36 POS ONLY)
- BE: BOTTOM ENTRY (SEE FIG. 6, USE CLT-XX-DBE-XX)
- A: ALIGNMENT PIN (MOLDED OR STAKED) (SEE FIGS. 3 & 4, SHT 2) (STAKED MIN 5 POS) (MOLDED MIN 3 POS)
- K: POLYIMIDE FILM PAD (AVAILABLE ON POS. 4 THRU 50 ONLY) (SEE FIG 5, SHT 2) (USE K-DOT-.197-.344-.005)

ROW SPEC.

- D DOUBLE ROW (USE CLT-XX-D EXCEPT FOR -BE OPTION)

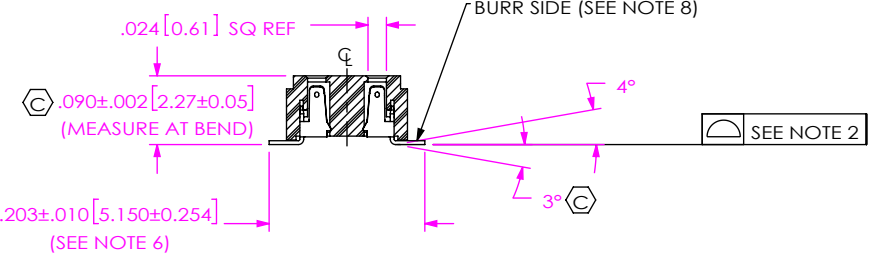
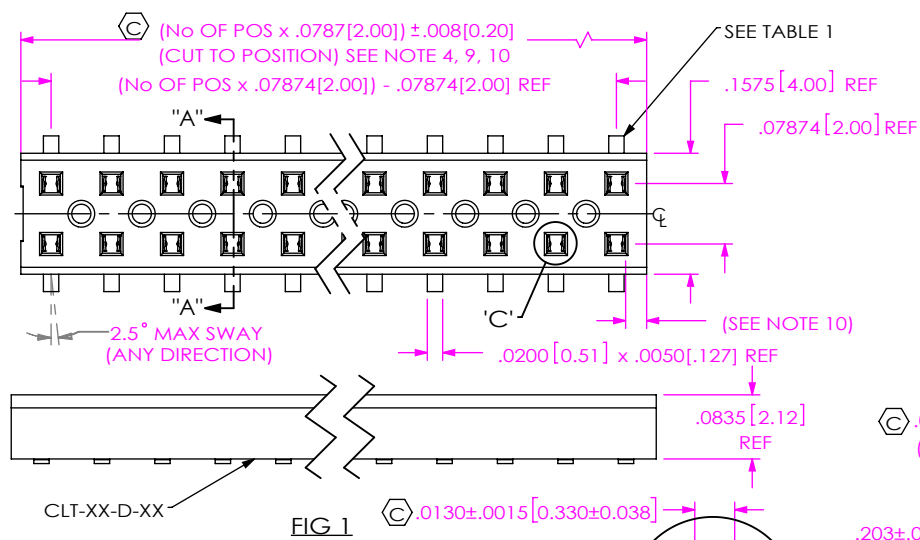

OPTION	USE CONTACT
CLT-150-02-L(M)-D-XX	C-114-22-L(M)
CLT-150-02-F(M)-D-XX	C-114-22-F(M)
CLT-150-02-G-D-XX	C-114-22-G
CLT-150-02-L(M)-D-BE-XX	C-114-22-L(M)
CLT-150-02-F(M)-D-BE-XX	C-114-22-F(M)
CLT-150-02-G-D-BE-XX	C-114-22-G
CLT-150-02-S(M)-D-BE-XX	C-114-22-S(M)
CLT-150-02-H-D-BE-XX	C-114-22-H
CLT-150-02-H-D-XX	C-114-22-H

SEE NOTE 12

- NOTES:
- ⊕ REPRESENTS A CRITICAL DIMENSION.
 - COPLANARITY TO BE .004 FOR POSITIONS 2-25, .006 FOR POSITIONS 26-34, AND .008 FOR 35-50.
 - MINIMUM PUSHOUT FORCE: .4 LB.
 - WILL LOSE A POSITION FOR EVERY CUT MADE ON A SOCKET STRIP.
 - ALL OPTIONS: PACKAGE POSITIONS -04 THRU -50 IN PT-CLX002-D TUBE AS SHOWN IN VIEWS, WITH TWO TP-12 PLUGS PER TUBE. LAYER PACKAGE POSITIONS -02 & -03.
 - SHEAR TAILS TO DIMENSION SHOWN.
 - PARTS TO BE SYMMETRICAL ABOUT ϕ
 - MAXIMUM BURR: .005[0.13]
 - MAXIMUM CUT FLASH: .010[0.25] WITH NO FLASH ALLOWED IN HOLES OR EXTENDING BELOW LEADS
 - MINIMUM STANDARD BODY ENDWALL AFTER CUTTING: .0215[0.546]
 - BE BODY ENDWALL AFTER CUTTING: .0169 ±.003 [0.429 ±0.08]
 - C-114-02 CAN BE USED FOR C-114-22. C-114-22-XX IS FOR AUTOMATED ASSEMBLY PROCESSES ONLY.

DETAIL 'C'
SCALE 16 : 1

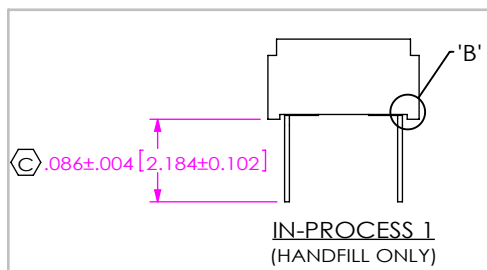

DETAIL 'B'
SCALE 16 : 1

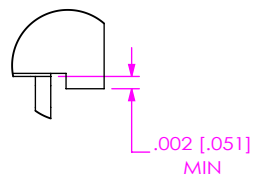

SECTION 'A'-'A'
SCALE 4 : 1

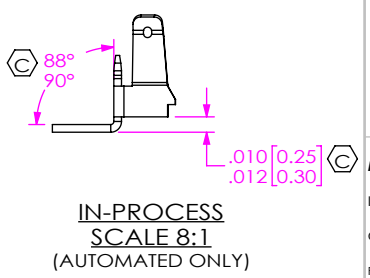
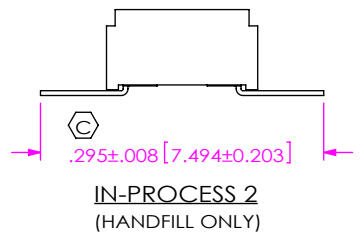

UNLESS OTHERWISE SPECIFIED, DIMENSIONS ARE IN INCHES.

TOLERANCES ARE:

DECIMALS	ANGLES
.XX: ±.01 [0.3]	°
.XXX: ±.005 [0.13]	
.XXXX: ±.0020 [0.051]	

MATERIAL: INSULATOR: LCP, UL 94 VO, COLOR BLACK
CONTACT: PHOS BRONZE

DO NOT SCALE DRAWING SHEET SCALE: 2:1

F:\DWG\MISC\MKTG\CLT-1XX-02-XX-D-XX-MKT.SLDRW

PROPRIETARY NOTE

THIS DOCUMENT CONTAINS CONFIDENTIAL AND PROPRIETARY INFORMATION AND ALL DESIGN, MANUFACTURING, REPRODUCTION, USE, PATENT RIGHTS AND SALES RIGHTS ARE EXPRESSLY RESERVED BY SAMTEC, INC. THIS DOCUMENT SHALL NOT BE DISCLOSED, IN WHOLE OR PART, TO ANY UNAUTHORIZED PERSON OR ENTITY NOR REPRODUCED, TRANSFERRED OR INCORPORATED IN ANY OTHER PROJECT IN ANY MANNER WITHOUT THE EXPRESS WRITTEN CONSENT OF SAMTEC, INC.



520 PARK EAST BLVD, NEW ALBANY, IN 47150
PHONE: 812-944-6733 FAX: 812-948-5047
e-Mail info@SAMTEC.com code 53322

DESCRIPTION: 2MM LOW PROFILE SOCKET STRIP

DWG. NO. CLT-1XX-02-XX-D-XX

BY: BRATCHER 10/03/1994 SHEET 1 OF 2

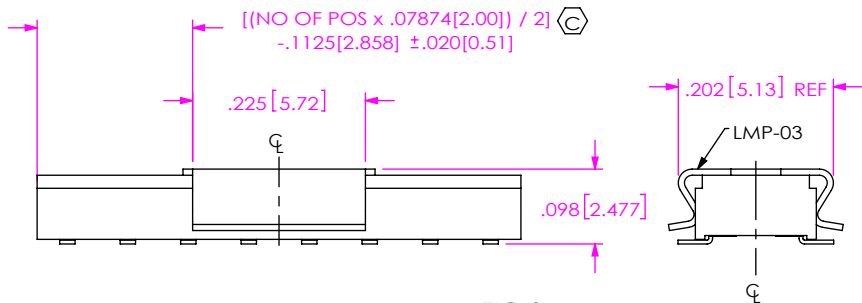
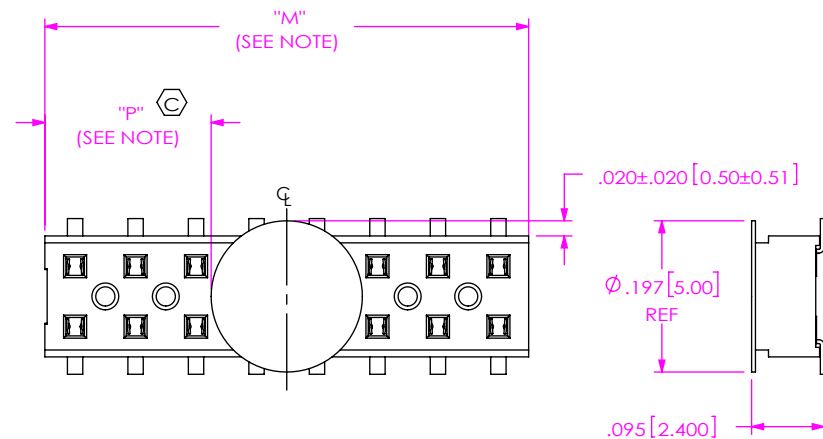

FIG 2
-P: PICK & PLACE PAD
(4 POS MIN)



NOTE: "M" = USED MEASURED DIMENSION (REF)
"P" = (("M" - .1969 [5.00]) / 2) ± .020[0.51]

FIG 5
-K OPTION
(4 POS MIN)

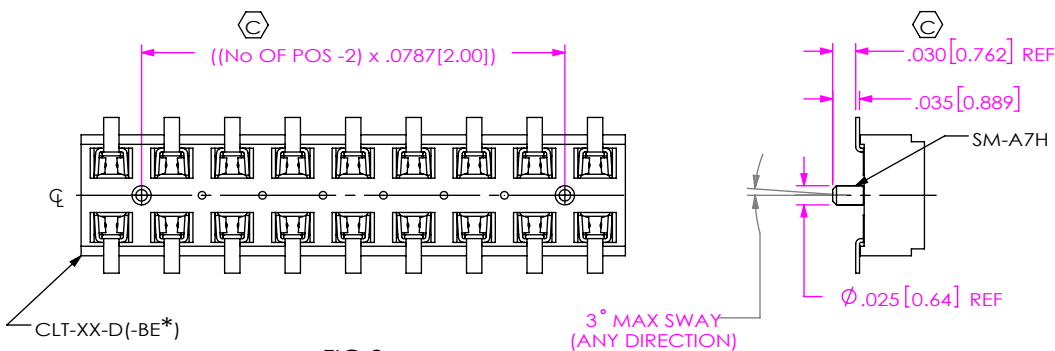
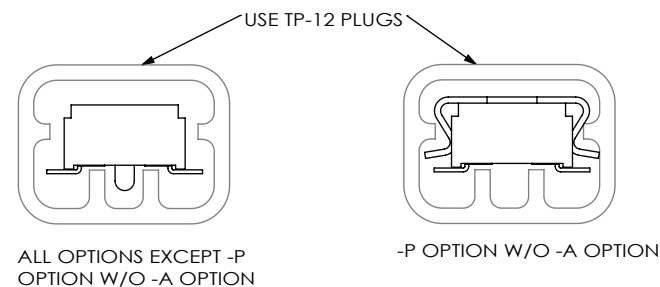

FIG 3
-A OPTION (STAKED)
(5 POS MIN)

* = FOR -BE OPTION ONLY



POSITIONS 04 - 50

PACKAGING VIEWS
(SEE NOTE 5)
PT-CLX002-D

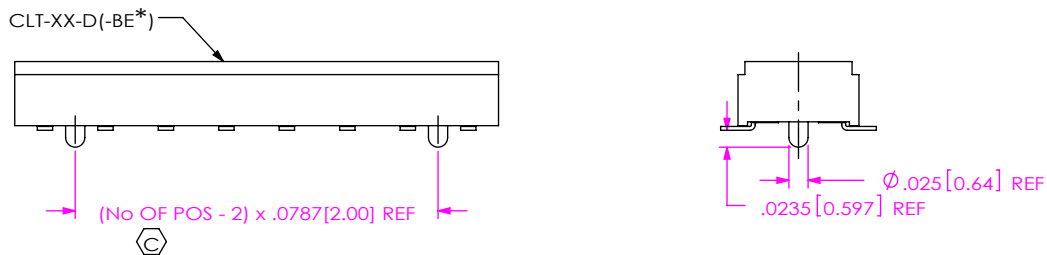

FIG 4
-A OPTION (MOLDED)
(3 POS MIN)

* = FOR -BE OPTION ONLY

PROPRIETARY NOTE
THIS DOCUMENT CONTAINS CONFIDENTIAL AND PROPRIETARY INFORMATION AND ALL DESIGN, MANUFACTURING, REPRODUCTION, USE, PATENT RIGHTS AND SALES RIGHTS ARE EXPRESSLY RESERVED BY SAMTEC, INC. THIS DOCUMENT SHALL NOT BE DISCLOSED, IN WHOLE OR PART, TO ANY UNAUTHORIZED PERSON OR ENTITY NOR REPRODUCED, TRANSFERRED OR INCORPORATED IN ANY OTHER PROJECT IN ANY MANNER WITHOUT THE EXPRESS WRITTEN CONSENT OF SAMTEC, INC.

DO NOT SCALE DRAWING
SHEET SCALE: 4:1



520 PARK EAST BLVD, NEW ALBANY, IN 47150
PHONE: 812-944-6733 FAX: 812-948-5047
e-Mail info@SAMTEC.com code 55322

DESCRIPTION:
2MM LOW PROFILE SOCKET STRIP

DWG. NO.
CLT-1XX-02-XX-D-XX

BY: BRATCHER 10/03/1994 SHEET 2 OF 2