

Schottky Diode Gen²

preliminary

$$V_{RRM} = 200V$$

$$I_{FAV} = 2 \times 35A$$

$$V_F = 0.79V$$

High Performance Schottky Diode
Low Loss and Soft Recovery
Common Cathode

Part number

DSA70C200HB

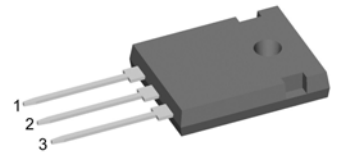

Backside: cathode

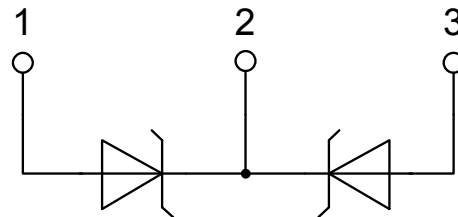
**Features / Advantages:**

- Very low V_f
- Extremely low switching losses
- Low I_{rm} values
- Improved thermal behaviour
- High reliability circuit operation
- Low voltage peaks for reduced protection circuits
- Low noise switching

Applications:

- Rectifiers in switch mode power supplies (SMPS)
- Free wheeling diode in low voltage converters

Package: TO-247

- Industry standard outline
- RoHS compliant
- Epoxy meets UL 94V-0

Schottky				Ratings			
Symbol	Definition	Conditions		min.	typ.	max.	Unit
V_{RSM}	max. non-repetitive reverse blocking voltage					200	V
V_{RRM}	max. repetitive reverse blocking voltage					200	V
I_R	reverse current, drain current	$V_R = 200$ V		$T_{VJ} = 25^\circ\text{C}$		640	μA
		$V_R = 200$ V		$T_{VJ} = 125^\circ\text{C}$		7	mA
V_F	forward voltage drop	$I_F = 35$ A		$T_{VJ} = 25^\circ\text{C}$		0.93	V
		$I_F = 70$ A				1.07	V
		$I_F = 35$ A		$T_{VJ} = 125^\circ\text{C}$		0.79	V
		$I_F = 70$ A				0.95	V
I_{FAV}	average forward current	$T_C = 150^\circ\text{C}$		$T_{VJ} = 175^\circ\text{C}$		35	A
		rectangular	$d = 0.5$				
V_{FO}	threshold voltage			$T_{VJ} = 175^\circ\text{C}$		0.55	V
r_F	slope resistance					4.8	m Ω
		} for power loss calculation only					
R_{thJC}	thermal resistance junction to case					0.7	K/W
R_{thCH}	thermal resistance case to heatsink				0.25		K/W
P_{tot}	total power dissipation			$T_C = 25^\circ\text{C}$		215	W
I_{FSM}	max. forward surge current	$t = 10$ ms; (50 Hz), sine; $V_R = 0$ V		$T_{VJ} = 45^\circ\text{C}$		550	A
C_J	junction capacitance	$V_R = 24$ V	$f = 1$ MHz	$T_{VJ} = 25^\circ\text{C}$		261	pF

preliminary

Package TO-247			Ratings			
Symbol	Definition	Conditions	min.	typ.	max.	Unit
I_{RMS}	RMS current	per terminal ¹⁾			70	A
T_{VJ}	virtual junction temperature		-55		175	°C
T_{op}	operation temperature		-55		150	°C
T_{stg}	storage temperature		-55		150	°C
Weight				6		g
M_D	mounting torque		0.8		1.2	Nm
F_C	mounting force with clip		20		120	N

Product Marking

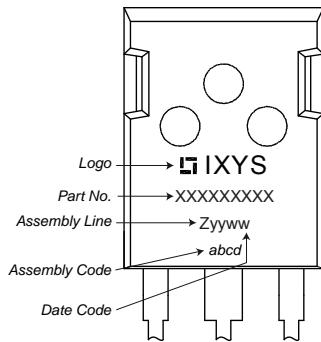

Part number

- D = Diode
- S = Schottky Diode
- A = low VF
- 70 = Current Rating [A]
- C = Common Cathode
- 200 = Reverse Voltage [V]
- HB = TO-247AD (3)

Ordering	Part Number	Marking on Product	Delivery Mode	Quantity	Code No.
Standard	DSA70C200HB	DSA70C200HB	Tube	30	509195

Equivalent Circuits for Simulation

* on die level

$T_{VJ} = 175\text{ °C}$



Schottky

$V_{0\max}$	threshold voltage	0.55	V
$R_{0\max}$	slope resistance *	2.2	mΩ

Outlines TO-247

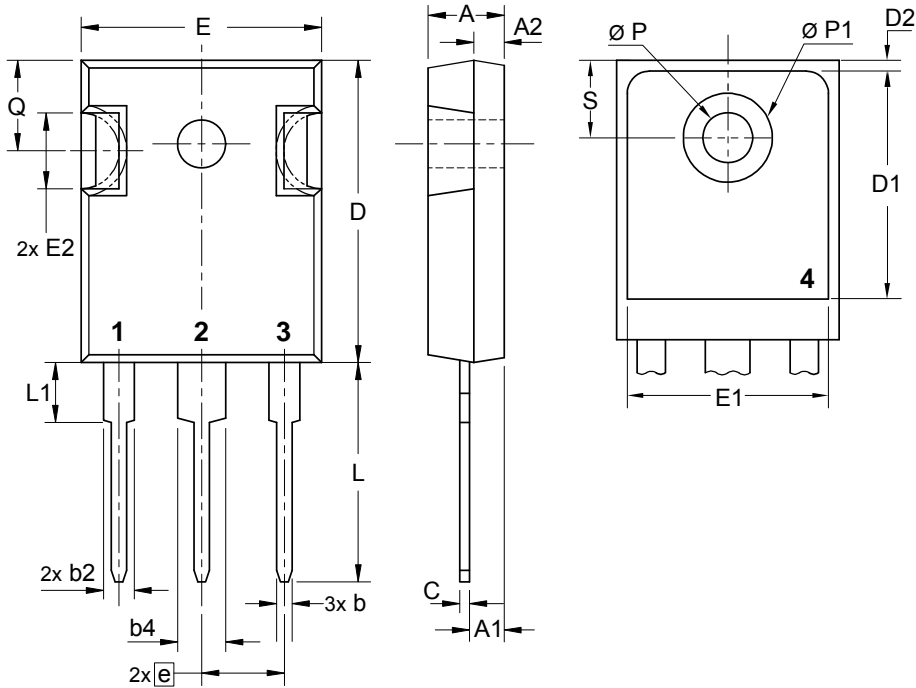

Sym.	Inches		Millimeter	
	min.	max.	min.	max.
A	0.185	0.209	4.70	5.30
A1	0.087	0.102	2.21	2.59
A2	0.059	0.098	1.50	2.49
D	0.819	0.845	20.79	21.45
E	0.610	0.640	15.48	16.24
E2	0.170	0.216	4.31	5.48
e	0.215 BSC		5.46 BSC	
L	0.780	0.800	19.80	20.30
L1	-	0.177	-	4.49
Ø P	0.140	0.144	3.55	3.65
Q	0.212	0.244	5.38	6.19
S	0.242 BSC		6.14 BSC	
b	0.039	0.055	0.99	1.40
b2	0.065	0.094	1.65	2.39
b4	0.102	0.135	2.59	3.43
c	0.015	0.035	0.38	0.89
D1	0.515	-	13.07	-
D2	0.020	0.053	0.51	1.35
E1	0.530	-	13.45	-
Ø P1	-	0.29	-	7.39

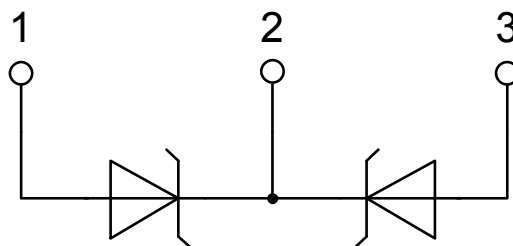

Schottky

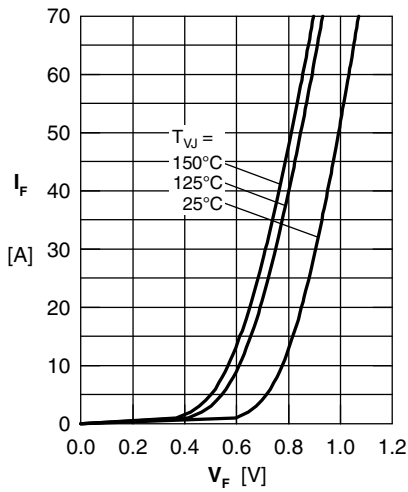

Fig. 1 Maximum forward voltage drop characteristics

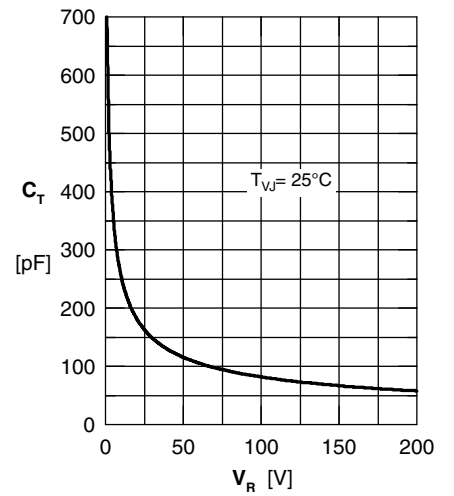

Fig. 3 Typ. junction capacitance C_T vs. reverse voltage V_R

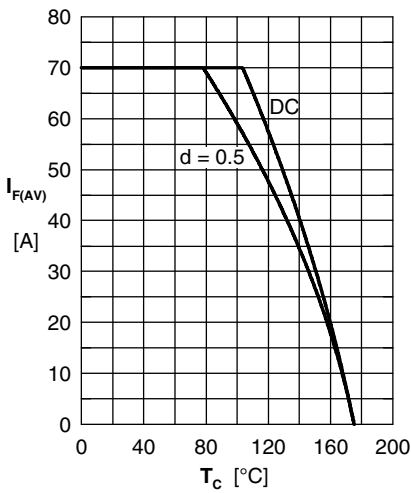

Fig. 4 Avg: forward current $I_{F(AV)}$ vs. case temperature T_C

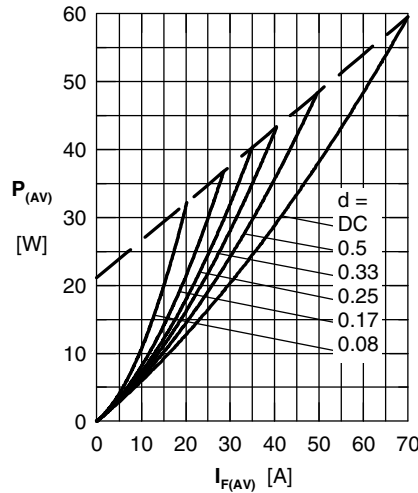

Fig. 5 Forward power loss characteristics

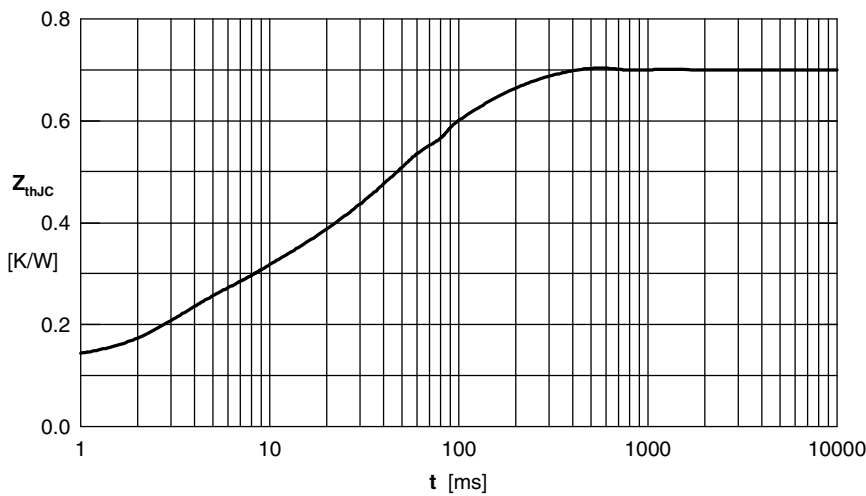

Fig. 6 Transient thermal impedance junction to case

Mouser Electronics

Authorized Distributor

Click to View Pricing, Inventory, Delivery & Lifecycle Information:

[IXYS:](#)

[DSA70C200HB](#)