

NCP3163, NCV3163

Inverting Converter, Switching Regulator - Buck Boost

3.4 A, 50-300 kHz

The NCP3163 Series is a performance enhancement to the popular MC33163 and MC34163 monolithic DC-DC converters. These devices consist of an internal temperature compensated reference, comparator, controlled duty cycle oscillator with an active current limit circuit, driver and high current output switch. This controller was specifically designed to be incorporated in step-down, step-up, or voltage-inverting applications with a minimum number of external components. The NCP3163 comes in an exposed pad package which can greatly increase the power dissipation of the built in power switch.

Features

- Output Switch Current in Excess of 3.0 A
- 3.4 A Peak Switch Current
- Frequency is Adjustable from 50 kHz to 300 kHz
- Operation from 2.5 V to 40 V Input
- Externally Adjustable Operating Frequency
- Precision 2% Reference for Accurate Output Voltage Control
- Driver with Bootstrap Capability for Increased Efficiency
- Cycle-by-Cycle Current Limiting
- Internal Thermal Shutdown Protection
- Low Voltage Indicator Output for Direct Microprocessor Interface
- Exposed Pad Power Package
- Low Standby Current
- NCV Prefix for Automotive and Other Applications Requiring Site and Change Control
- These are Pb-Free Devices



ON Semiconductor®

<http://onsemi.com>

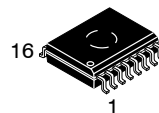

SOIC-16W
EXPOSED PAD
PW SUFFIX
CASE 751AG

MARKING DIAGRAMS

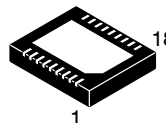
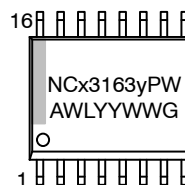

18-LEAD DFN
MN SUFFIX
CASE 505



NCx3163y = Specific Device Code
x = P or V
y = blank or B
A = Assembly Location
WL = Wafer Lot
YY = Year
WW = Work Week
G or ■ = Pb-Free Package

(Note: Microdot may be in either location)

ORDERING INFORMATION

See detailed ordering and shipping information in the package dimensions section on page 19 of this data sheet.

*For additional information on our Pb-Free strategy and soldering details, please download the ON Semiconductor Soldering and Mounting Techniques Reference Manual, SOLDERRM/D.

NCP3163, NCV3163

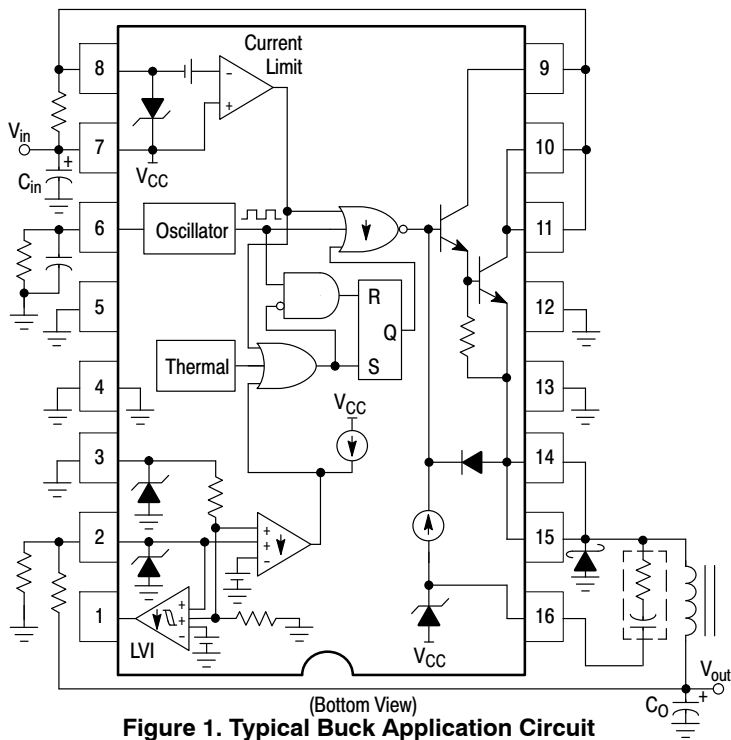

Figure 1. Typical Buck Application Circuit

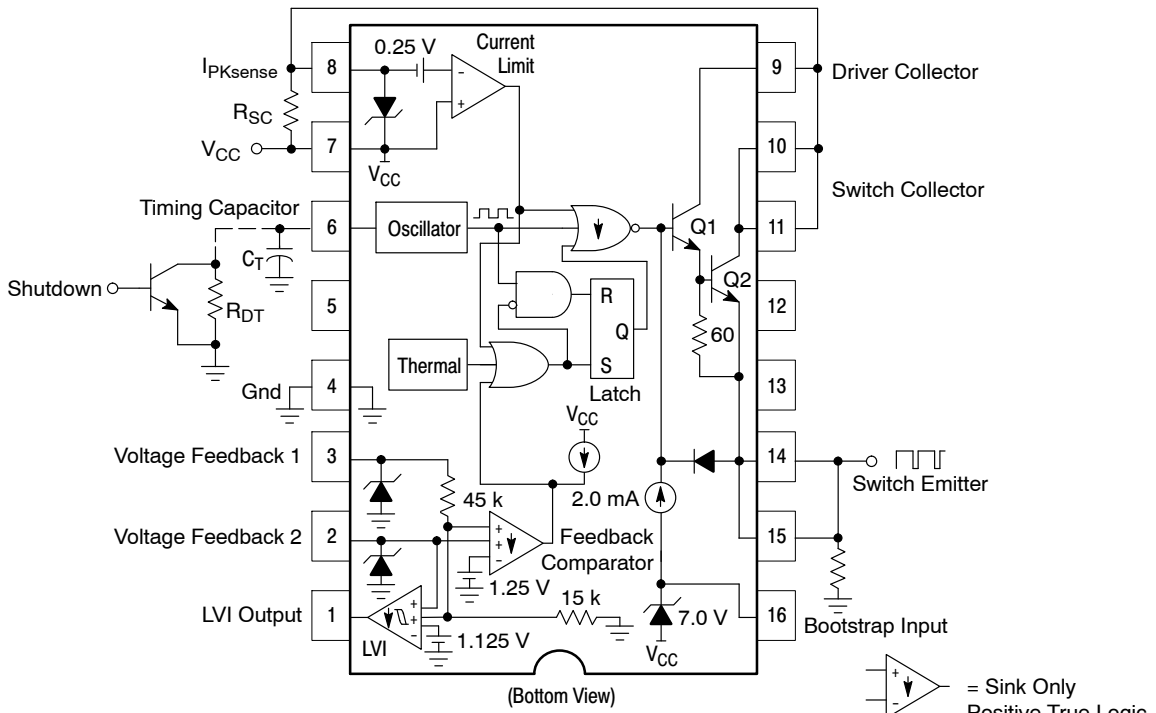

Figure 2. Representative Block Diagram

NCP3163, NCV3163

PIN FUNCTION DESCRIPTION

SOIC16	DFN18	PIN NAME	DESCRIPTION
1	15	LVI Output	This pin will sink current when FB1 and FB2 are less than the LVI threshold (V_{th}).
2	16	Voltage Feedback 2	Connecting this pin to a resistor divider off of the output will regulate the application according to the V_{out} design equation in Figure 22.
3	17	Voltage Feedback 1	Connecting this pin directly to the output will regulate the device to 5.05 V.
4	18	GND	Ground pin for all internal circuits and power switch.
6	1	Timing Capacitor	Connect a capacitor to this pin to set the frequency. The addition of a parallel resistor will decrease the maximum duty cycle and increase the frequency.
7	3	V_{CC}	Power pin for the IC.
8	4	I_{pk} Sense	When $(V_{CC} - V_{IPKsense}) > 250$ mV the circuit resets the output driver on a pulse by pulse basis.
9	5	Drive Collector	Voltage driver collector
10,11	6,7,8,9	Switch Collector	Internal switch transistor collector
14,15	10,11,12,13	Switch Emitter	Internal switch transistor emitter
16	14	Bootstrap Input	Connect this pin to V_{CC} for operation at low V_{CC} levels. For some topologies, a series resistor and capacitor can be utilized to improve the converter efficiency.
5,12,13	2	No Connect	These pins have no connection.
Exposed Pad	Exposed Pad	Exposed Pad	The exposed pad beneath the package must be connected to GND (pin 4). Additionally, using proper layout techniques, the exposed pad can greatly enhance the power dissipation capabilities of the NCP3163.

MAXIMUM RATINGS (Note 1)

Rating	Symbol	Value	Unit
Power Supply Voltage	V_{CC}	0 to +40	V
Switch Collector Voltage Range	V_{CSW}	-1.0 to +40	V
Switch Emitter Voltage Range	V_{ESW}	-2.0 to +40	V
Switch Collector to Emitter Voltage	V_{CESW}	+40	V
Switch Current	I_{SW}	3.4	A
Driver Collector Voltage (Pin 8)	V_{CC}	-1.0 to +40	V
Driver Collector Current (Pin 8)	I_{CC}	150	mA
Bootstrap Input Current Range	I_{BST}	-100 to +100	mA
Current Sense Input Voltage Range	V_{IPKSNS}	$(V_{CC} - 7.0)$ to $(V_{CC} + 1.0)$	V
Feedback and Timing Capacitor Input Voltage Range	V_{in}	-1.0 to +7.0	V
Low Voltage Indicator Output Voltage Range	V_{CLVI}	-1.0 to +40	V
Low Voltage Indicator Output Sink Current	I_{CLVI}	10	mA
Power Dissipation and Thermal Characteristics			
Thermal Characteristics			°C/W
Thermal Resistance, Junction-to-Case	$R_{\theta JC}$	15	
Thermal Resistance, Junction-to-Air	$R_{\theta JA}$	56	
Storage Temperature Range	T_{stg}	-65 to +150	°C
Maximum Junction Temperature	T_{Jmax}	+150	°C
Operating Ambient Temperature (Note 3)	T_A		°C
NCP3163		0 to +70	
NCP3163B		-40 to +85	
NCV3163		-40 to +125	

Stresses exceeding Maximum Ratings may damage the device. Maximum Ratings are stress ratings only. Functional operation above the Recommended Operating Conditions is not implied. Extended exposure to stresses above the Recommended Operating Conditions may affect device reliability.

- This device series contains ESD protection and exceeds the following tests:
 Human Body Model 2000 V per MIL-STD-883, Method 3015.
 Machine Model Method 200 V.
 Charged Device Model 750 V for corner pins and 500 V for others (according to AEC-Q100).

NCP3163, NCV3163

2. This device contains latch-up protection and exceeds 100 mA per JEDEC Standard JESD78.
3. Maximum package power dissipation limits must be observed. Maximum Junction Temperature must not be exceeded.
4. The pins which are not defined may not be loaded by external signals.

PIN CONNECTIONS

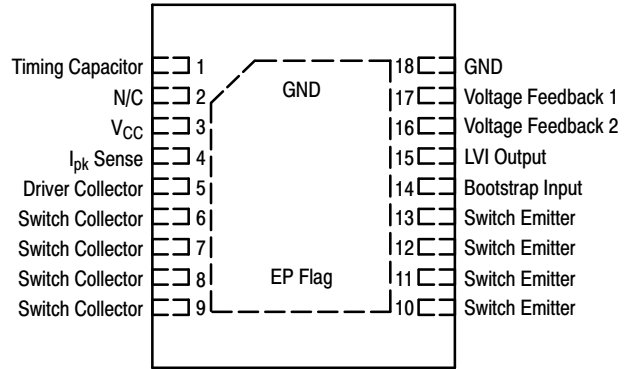
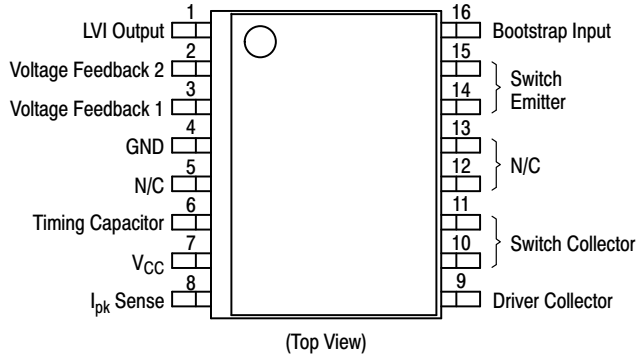

NCP3163, NCV3163

ELECTRICAL CHARACTERISTICS ($V_{CC} = 15\text{ V}$, Pin 16 = V_{CC} , $C_T = 270\text{ pF}$, $R_T = 15\text{ k}\Omega$, for typical values $T_A = 25^\circ\text{C}$, for min/max values T_A is the operating ambient temperature range that applies (Note 7), unless otherwise noted.)

Characteristic	Symbol	Min	Typ	Max	Unit
OSCILLATOR					
Frequency $T_A = 25^\circ\text{C}$, $V_{CC} = 15\text{ V}$ Total Variation over $V_{CC} = 2.5\text{ V}$ to 40 V and Temperature	f_{OSC}	225 212	250 250	275 288	kHz
Charge Current	I_{chg}	–	225	–	μA
Discharge Current	I_{dischg}	–	25	–	μA
Charge to Discharge Current Ratio	I_{chg}/I_{dischg}	8.0 7.0	9.0 9.0	10.5 10.5	–
Sawtooth Peak Voltage	$V_{OSC(P)}$	–	1.25	–	V
Sawtooth Valley Voltage	$V_{OSC(V)}$	–	0.55	–	V
FEEDBACK COMPARATOR 1					
Threshold Voltage $T_A = 25^\circ\text{C}$ Total Variation over $V_{CC} = 2.5\text{ V}$ to 40 V and Temperature	$V_{th(FB1)}$	4.9 4.85	5.05 –	5.2 5.25	V
Threshold Voltage – Line Regulation ($V_{CC} = 2.5\text{ V}$ to 40 V , $T_A = 25^\circ\text{C}$)	$REG_{line(FB1)}$	–	0.008	0.03	%/V
Input Bias Current ($V_{FB1} = 5.05\text{ V}$)	$I_{IB(FB1)}$	–	100	200	μA
FEEDBACK COMPARATOR 2					
Threshold Voltage $T_A = 25^\circ\text{C}$, $V_{CC} = 15\text{ V}$ Total Variation over $V_{CC} = 2.5\text{ V}$ to 40 V and Temperature	$V_{th(FB2)}$	1.225 1.213	1.25 –	1.275 1.287	V
Threshold Voltage – Line Regulation ($V_{CC} = 2.5\text{ V}$ to 40 V , $T_A = 25^\circ\text{C}$)	$REG_{line(FB1)}$	–	0.008	0.03	%/V
Input Bias Current ($V_{FB2} = 1.25\text{ V}$)	$I_{IB(FB2)}$	–0.4	–	0.4	μA
CURRENT LIMIT COMPARATOR					
Threshold Voltage $T_A = 25^\circ\text{C}$ Total Variation over $V_{CC} = 2.5\text{ V}$ to 40 V , and Temperature	$V_{th(Sense)}$	– 225	250 –	– 270	mV
Input Bias Current ($V_{Ipk(Sense)} = 15\text{ V}$)	$I_{IB(Sense)}$	–	1.0	20	μA
DRIVER AND OUTPUT SWITCH (Note 6)					
Saturation Voltage ($I_{SW} = 2.5\text{ A}$, Pins 14, 15 grounded) Non-Darlington ($R_{Pin9} = 110\ \Omega$ to V_{CC} , $I_{SW}/I_{DRV} \approx 20$)	$V_{CE(sat)}$	–	0.6	1.0	V
Darlington Connection (Pins 9, 10, 11 connected)		–	1.0	1.4	
		–	1.0	1.5	
Collector Off-State Leakage Current ($V_{CE} = 40\text{ V}$)	$I_{C(off)}$	–	0.02	100	μA
Bootstrap Input Current Source ($V_{BS} = V_{CC} + 5.0\text{ V}$)	$I_{source(DRV)}$	0.5	2.0	4.0	mA
Bootstrap Input Zener Clamp Voltage ($I_Z = 25\text{ mA}$)	V_Z	$V_{CC} + 6.0$	$V_{CC} + 7.0$	$V_{CC} + 9.0$	V
LOW VOLTAGE INDICATOR					
Input Threshold (V_{FB2} Increasing)	V_{th}	1.07	1.125	1.18	V
Input Hysteresis (V_{FB2} Decreasing)	V_H	–	15	–	mV
Output Sink Saturation Voltage ($I_{sink} = 2.0\text{ mA}$)	$V_{OL(LVI)}$	–	0.15	0.4	V
Output Off-State Leakage Current ($V_{OH} = 15\text{ V}$)	I_{OH}	–	0.01	5.0	μA
TOTAL DEVICE					
Standby Supply Current ($V_{CC} = 2.5\text{ V}$ to 40 V , Pin 8 = V_{CC} , Pins 6, 14, 15 = GND, remaining pins open)	I_{CC}	–	6.0	10	mA

5. Maximum package power dissipation limits must be observed.
6. Low duty cycle pulse techniques are used during test to maintain junction temperature as close to ambient as possible.
7. $T_{low} = 0^\circ\text{C}$ for NCP3163 $T_{high} = +70^\circ\text{C}$ for NCP3163
 = -40°C for NCP3163B = $+85^\circ\text{C}$ for NCP3163B
 = -40°C for NCV3163 = $+125^\circ\text{C}$ for NCV3163

NCP3163, NCV3163

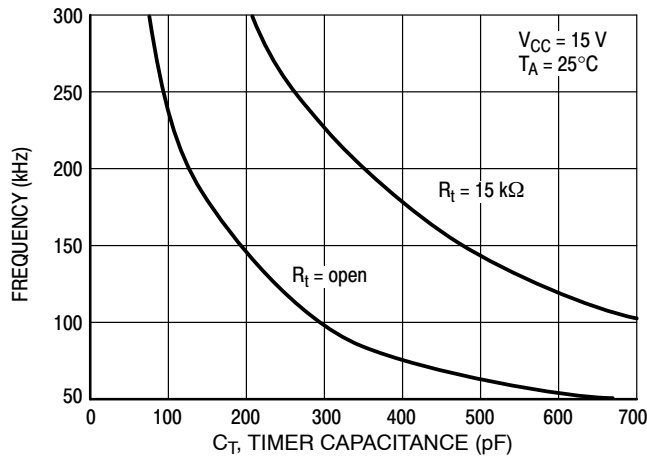

Figure 3. Oscillator Frequency vs. Timer Capacitance (C_T)

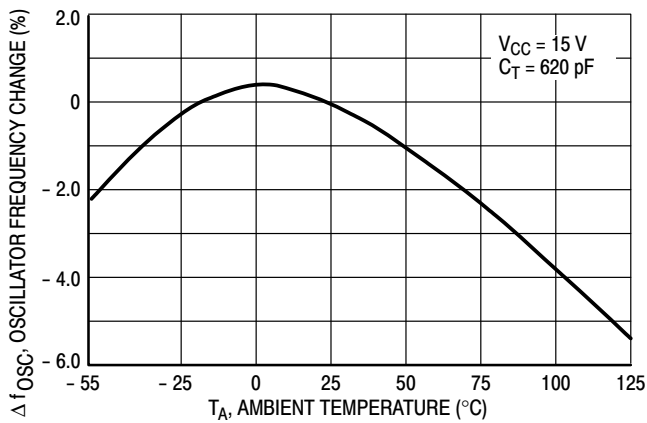

Figure 4. Oscillator Frequency Change vs. Temperature when only C_T is connected to Pin 6

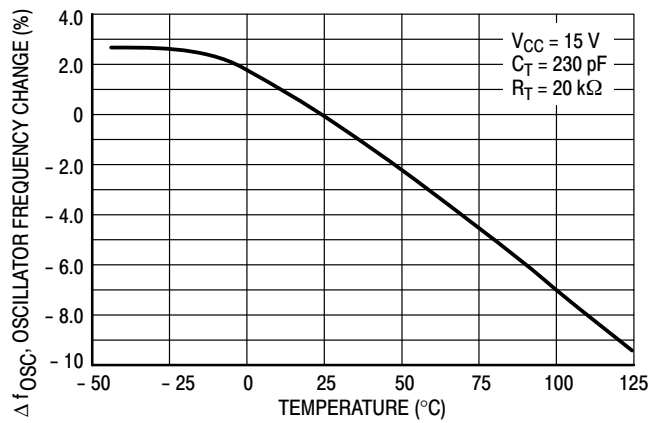

Figure 5. Oscillator Frequency Change vs. Temperature when C_T and R_T are connected to Pin 6

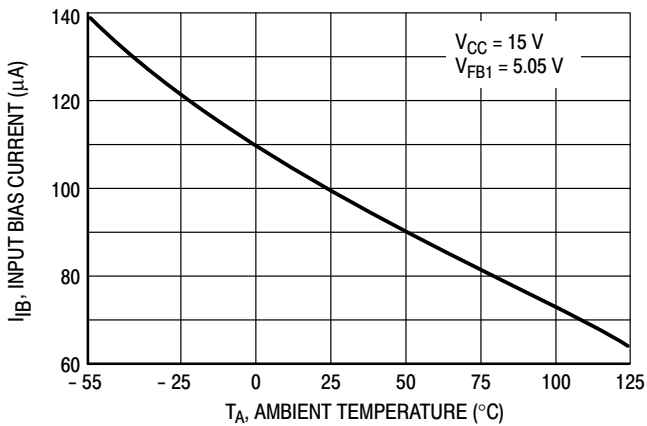

Figure 6. Feedback Comparator 1 Input Bias Current vs. Temperature

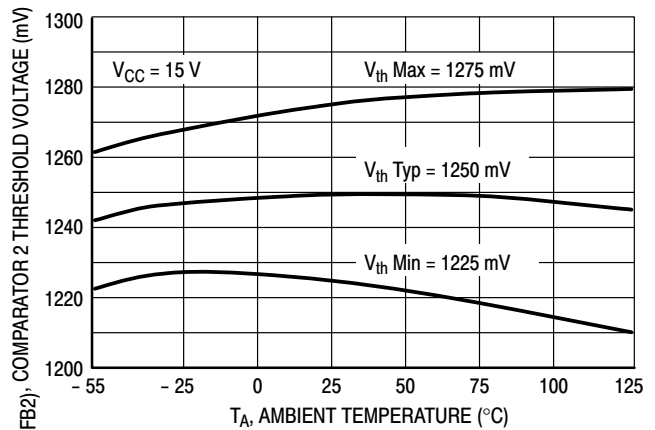

Figure 7. Feedback Comparator 2 Threshold Voltage vs. Temperature

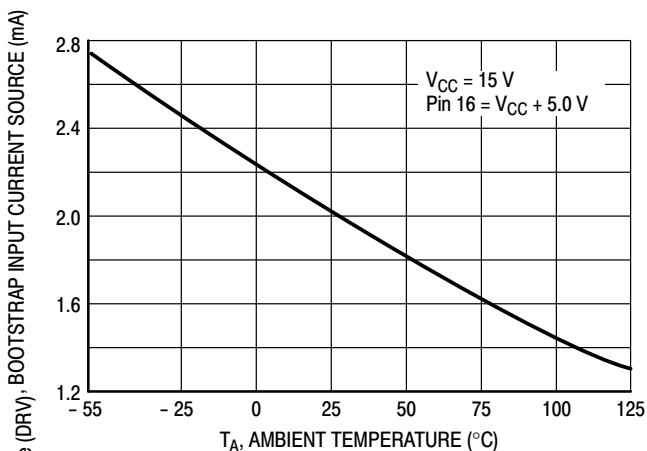

Figure 8. Bootstrap Input Current Source vs. Temperature

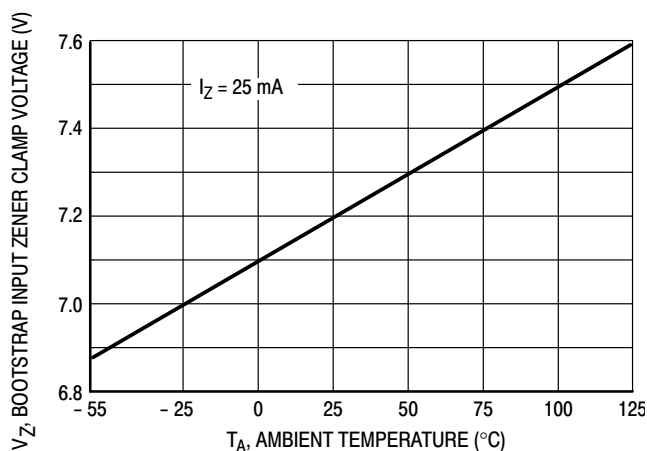

Figure 9. Bootstrap Input Zener Clamp Voltage vs. Temperature

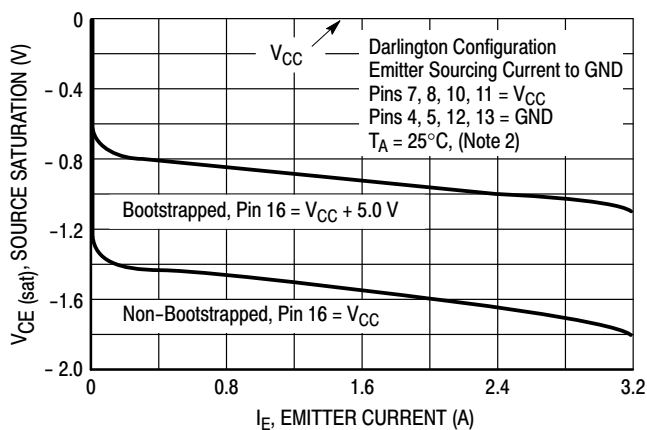

Figure 10. Output Switch Source Saturation vs. Emitter Current

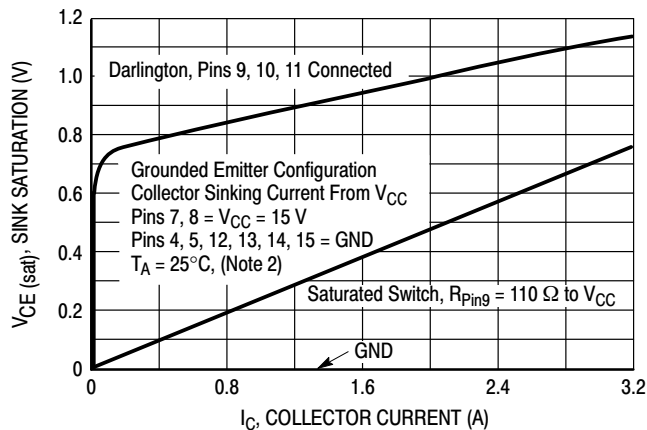

Figure 11. Output Switch Sink Saturation vs. Collector Current

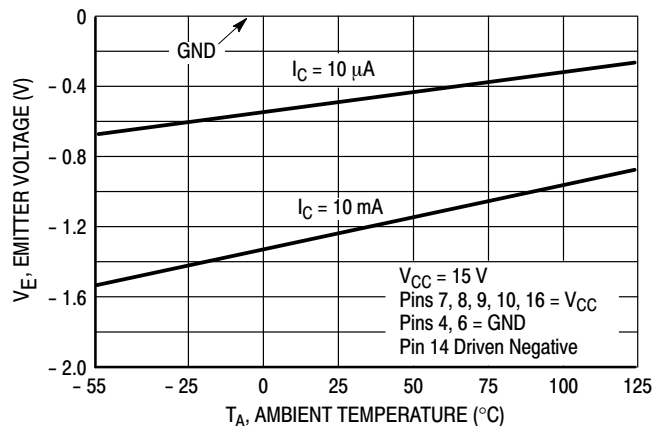

Figure 12. Output Switch Negative Emitter Voltage vs. Temperature

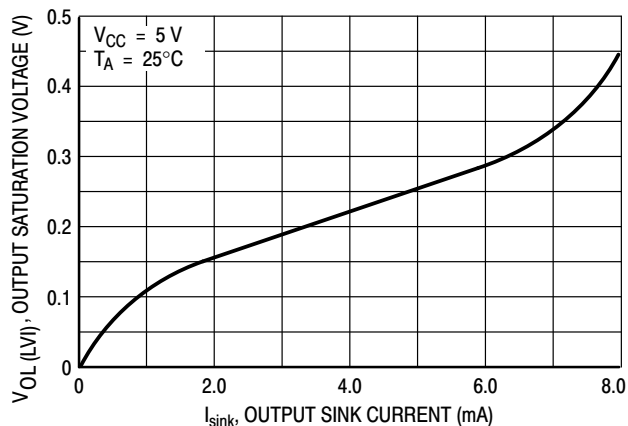

Figure 13. Low Voltage Indicator Output Sink Saturation Voltage vs. Sink Current

NCP3163, NCV3163

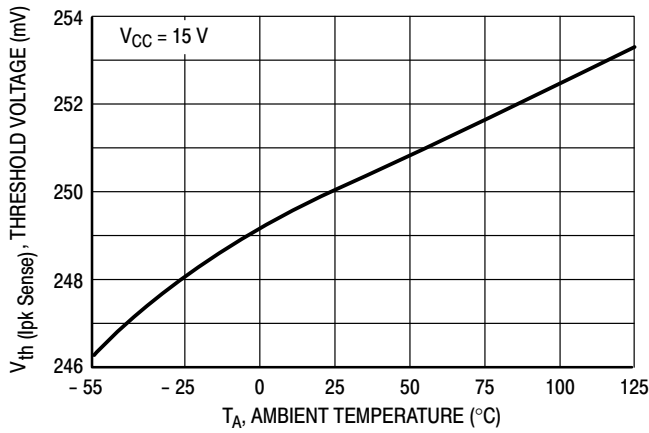

Figure 14. Current Limit Comparator Threshold Voltage vs. Temperature

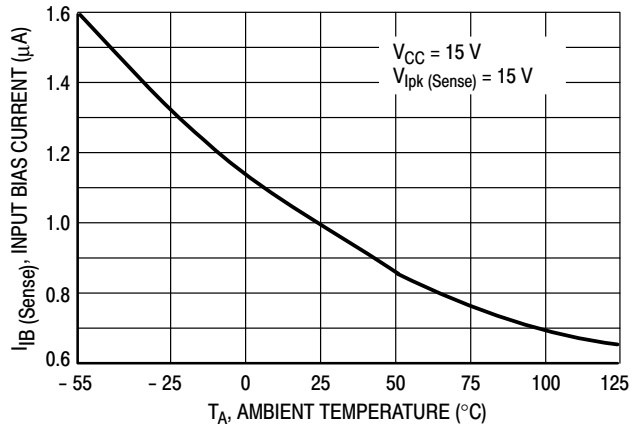

Figure 15. Current Limit Comparator Input Bias Current vs. Temperature

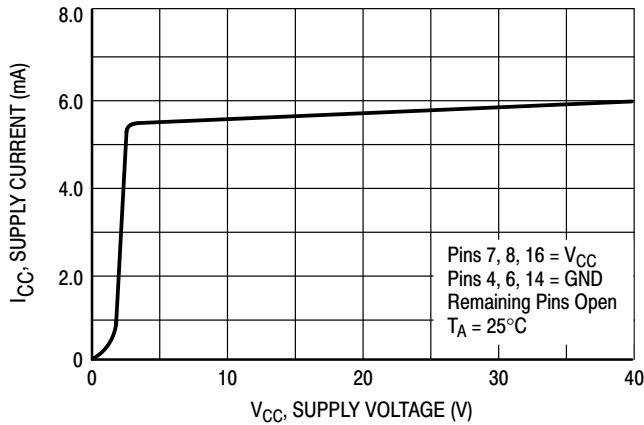

Figure 16. Standby Supply Current vs. Supply Voltage

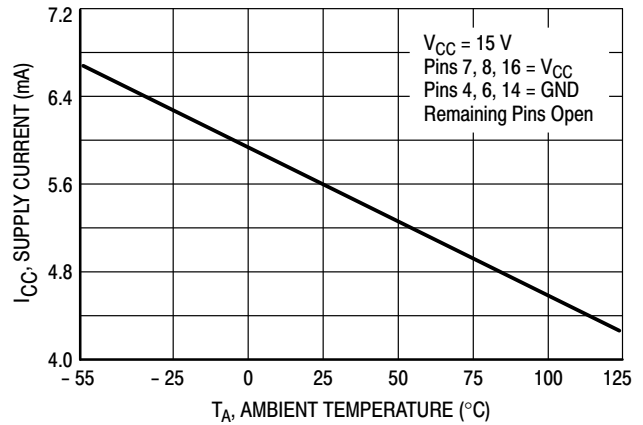

Figure 17. Standby Supply Current vs. Temperature

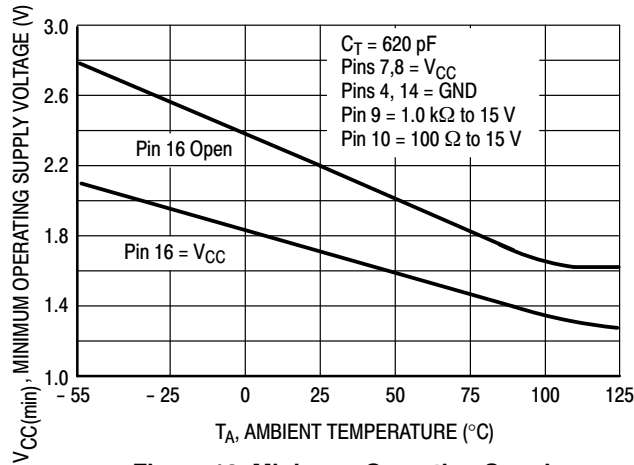

Figure 18. Minimum Operating Supply Voltage vs. Temperature

INTRODUCTION

The NCP3163 is a monolithic power switching regulator optimized for DC-to-DC converter applications. The combination of its features enables the system designer to directly implement step-up, step-down, and voltage-inverting converters with a minimum number of external components. Potential applications include cost sensitive consumer products as well as equipment for the automotive, computer, and industrial markets. A representative block diagram is shown in Figure 2.

OPERATING DESCRIPTION

The NCP3163 operates as a fixed on-time, variable off-time voltage mode ripple regulator. In general, this mode of operation is somewhat analogous to a capacitor charge pump and does not require dominant pole loop compensation for converter stability. The Typical Operating Waveforms are shown in Figure 19. The output voltage waveform shown is for a step-down converter with the ripple and phasing exaggerated for clarity. During initial converter startup, the feedback comparator senses that the output voltage level is below nominal. This causes the output switch to turn on and off at a frequency and duty cycle controlled by the oscillator, thus pumping up the output filter capacitor. When the output voltage level reaches nominal, the feedback comparator sets the latch, immediately terminating switch conduction. The feedback comparator will inhibit the switch until the load current causes the output voltage to fall below nominal. Under these conditions, output switch conduction can be inhibited for a partial

oscillator cycle, a partial cycle plus a complete cycle, multiple cycles, or a partial cycle plus multiple cycles.

Oscillator

The oscillator frequency and on-time of the output switch are programmed by the value selected for timing capacitor C_T . Capacitor C_T is charged and discharged by a 9 to 1 ratio internal current source and sink, generating a negative going sawtooth waveform at Pin 6. As C_T charges, an internal pulse is generated at the oscillator output. This pulse is connected to the NOR gate center input, preventing output switch conduction, and to the AND gate upper input, allowing the latch to be reset if the comparator output is low. Thus, the output switch is always disabled during ramp-up and can be enabled by the comparator output only at the start of ramp-down. The oscillator peak and valley thresholds are 1.25 V and 0.55 V, respectively, with a charge current of 225 μ A and a discharge current of 25 μ A, yielding a maximum on-time duty cycle of 90%. A reduction of the maximum duty cycle may be required for specific converter configurations. This can be accomplished with the addition of an external deadtime resistor (R_{DT}) placed across C_T . The resistor increases the discharge current which reduces the on-time of the output switch. The converter output can be inhibited by clamping C_T to ground with an external NPN small-signal transistor. To calculate the frequency when only C_T is connected to Pin 6, use the equations found in Figure 22. When R_T is also used, the frequency and maximum duty cycle can be calculated with the NCP3163 design tool found at www.onsemi.com.

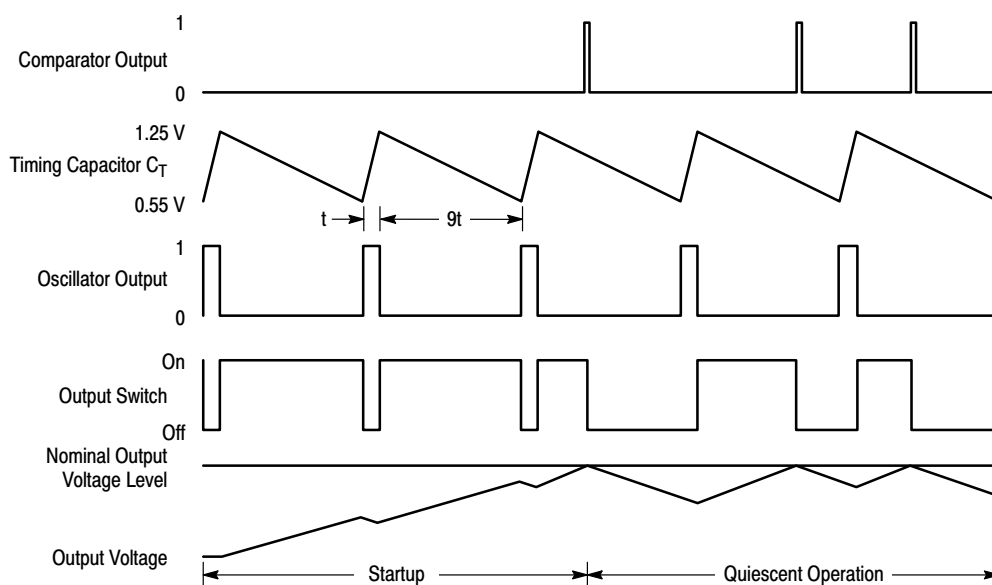

Figure 19. Typical Operating Waveforms

Feedback and Low Voltage Indicator Comparators

Output voltage control is established by the Feedback comparator. The inverting input is internally biased at 1.25 V and is not pinned out. The converter output voltage is typically divided down with two external resistors and monitored by the high impedance noninverting input at Pin 2. The maximum input bias current is $\pm 0.4 \mu\text{A}$, which can cause an output voltage error that is equal to the product of the input bias current and the upper divider resistance value. For applications that require 5.0 V, the converter output can be directly connected to the noninverting input at Pin 3. The high impedance input, Pin 2, must be grounded to prevent noise pickup. The internal resistor divider is set for a nominal voltage of 5.05 V. The additional 50 mV compensates for a 1.0% voltage drop in the cable and connector from the converter output to the load. The Feedback comparator's

output state is controlled by the highest voltage applied to either of the two noninverting inputs.

The Low Voltage Indicator (LVI) comparator is designed for use as a reset controller in microprocessor-based systems. The inverting input is internally biased at 1.125 V, which sets the noninverting input thresholds to 90% of nominal. The LVI comparator has 15 mV of hysteresis to prevent erratic reset operation. The Open Collector output is capable of sinking in excess of 6.0 mA (see Figure 13). An external resistor (R_{LVI}) and capacitor (C_{DLY}) can be used to program a reset delay time (t_{DLY}) by the formula shown below, where $V_{th(MPU)}$ is the microprocessor reset input threshold. Refer to Figure 20.

$$t_{DLY} = R_{LVI} \cdot C_{DLY} \cdot \ln \left(\frac{1}{1 - \frac{V_{th(MPU)}}{V_{out}}} \right)$$

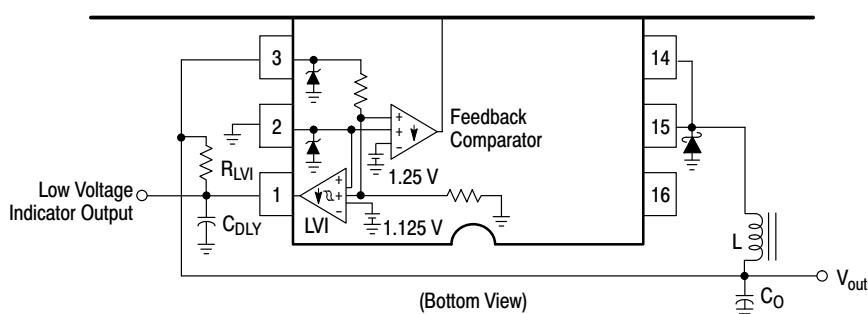

Figure 20. Partial Application Schematic Showing Implementation of LVI Delay with R_{LVI} and C_{DLY}

Current Limit Comparator, Latch and Thermal Shutdown

With a voltage mode ripple converter operating under normal conditions, output switch conduction is initiated by the oscillator and terminated by the Voltage Feedback comparator. Abnormal operating conditions occur when the converter output is overloaded or when feedback voltage sensing is lost. Under these conditions, the Current Limit comparator will protect the Output Switch.

The switch current is converted to a voltage by inserting a fractional ohm resistor, R_{SC} , in series with V_{CC} and output switch transistor Q_2 . The voltage drop across R_{SC} is monitored by the Current Sense comparator. If the voltage drop exceeds 250 mV with respect to V_{CC} , the comparator will set the latch and terminate output switch conduction on a cycle-by-cycle basis. This Comparator/Latch configuration ensures that the Output Switch has only a single on-time during a given oscillator cycle. The calculation for a value of R_{SC} is:

$$R_{SC} = \frac{0.25 \text{ V}}{I_{pk} \text{ (Switch)}}$$

Figures 14 and 15 show that the Current Sense comparator threshold is tightly controlled over temperature and has a typical input bias current of $1.0 \mu\text{A}$. The propagation delay from the comparator input to the Output Switch is typically

200 ns. The parasitic inductance associated with R_{SC} and the circuit layout should be minimized. This will prevent unwanted voltage spikes that may falsely trip the Current Limit comparator.

Internal thermal shutdown circuitry is provided to protect the IC in the event that the maximum junction temperature is exceeded. When activated, typically at 170°C , the Latch is forced into the "Set" state, disabling the Output Switch. This feature is provided to prevent catastrophic failures from accidental device overheating. It is not intended to be used as a replacement for proper heatsinking.

Driver and Output Switch

To aid in system design flexibility and conversion efficiency, the driver current source and collector, and output switch collector and emitter are pinned out separately. This allows the designer the option of driving the output switch into saturation with a selected force gain or driving it near saturation when connected as a Darlington. The output switch has a typical current gain of 70 at 2.5 A and is designed to switch a maximum of 40 V collector to emitter, with up to 3.4 A peak collector current. The minimum value for R_{SC} is:

$$R_{SC(\text{min})} = \frac{0.25 \text{ V}}{3.4 \text{ A}} = 0.0735 \Omega$$

NCP3163, NCV3163

When configured for step-down or voltage-inverting applications (see application notes at the end of this document) the inductor will forward bias the output rectifier when the switch turns off. Rectifiers with a high forward voltage drop or long turn-on delay time should not be used. If the emitter is allowed to go sufficiently negative, collector current will flow, causing additional device heating and reduced conversion efficiency.

Figure 12 shows that by clamping the emitter to 0.5 V, the collector current will be in the range 10 μ A over temperature. A 1N5822 or equivalent Schottky barrier rectifier is recommended to fulfill these requirements.

A bootstrap input is provided to reduce the output switch saturation voltage in step-down and voltage-inverting converter applications. This input is connected through a series resistor and capacitor to the switch emitter and is used to raise the internal 2.0 mA bias current source above V_{CC} . An internal zener limits the bootstrap input voltage to $V_{CC} + 7.0$ V. The capacitor's equivalent series resistance must limit the zener current to less than 100 mA. An additional series resistor may be required when using tantalum or other

low ESR capacitors. The equation below is used to calculate a minimum value bootstrap capacitor based on a minimum zener voltage and an upper limit current source.

$$C_{B(\min)} = I \frac{\Delta t}{\Delta V} = 4.0 \text{ mA} \frac{t_{\text{on}}}{4.0 \text{ V}} = 0.001 t_{\text{on}}$$

Parametric operation of the NCP3163 is guaranteed over a supply voltage range of 2.5 V to 40 V. When operating below 3.0 V, the Bootstrap Input should be connected to V_{CC} . Figure 18 shows that functional operation down to 1.7 V at room temperature is possible.

Package

The NCP3163 is contained in a heatsinkable 16-lead plastic package in which the die is mounted on a special heat tab copper alloy pad. This pad is designed to be soldered directly to a GND connection on the printed circuit board to improve thermal conduction. Since this pad directly contacts the substrate of the die, it is important that this pad be always soldered to GND, even if surface mount heat sinking is not being used. Figure 21 shows recommended layout techniques for this package.

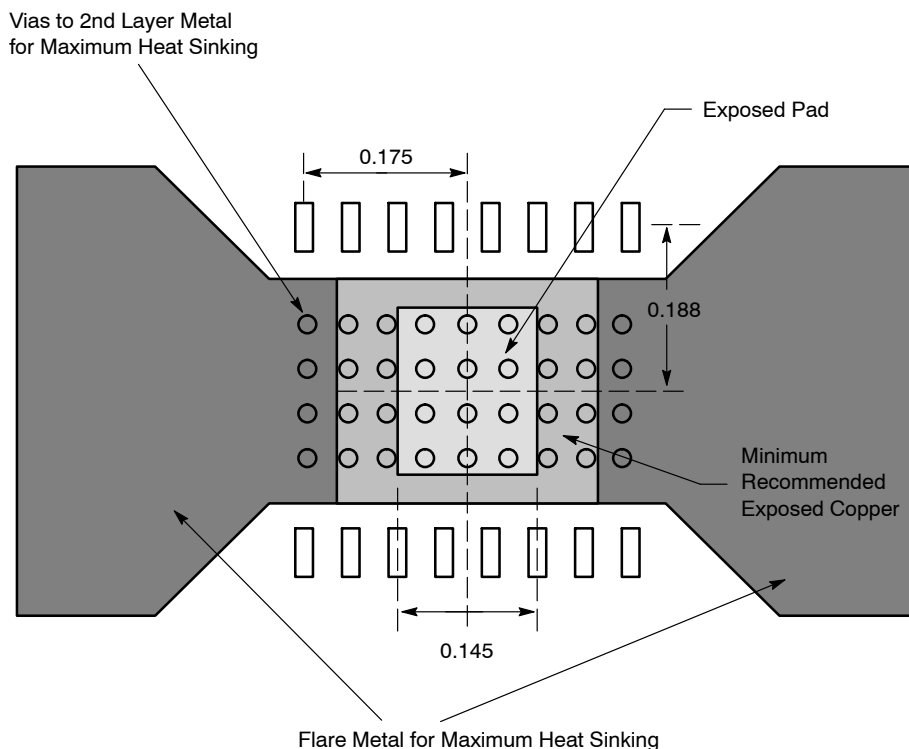

Figure 21. Layout Guidelines to Obtain Maximum Package Power Dissipation

APPLICATIONS

Figures 23 through 30 show the simplicity and flexibility of the NCP3163. Three main converter topologies are demonstrated with actual test data shown below each of the circuit diagrams. Figure 22 gives the relevant design

equations for the key parameters. Additionally, a complete application design aid for the NCP3163 can be found at www.onsemi.com.

NCP3163, NCV3163

Calculation	Step-Down	Step-Up	Voltage-Inverting
(See Notes 1,2,3) $\frac{t_{on}}{t_{off}}$	$\frac{V_{out} + V_F}{V_{in} - V_{sat} - V_{out}}$	$\frac{V_{out} + V_F \frac{V_{in}}{V_{sat}}}{V_{in} \frac{V_{in}}{V_{sat}}}$	$\frac{ V_{out} + V_F}{V_{in} - V_{sat}}$
t_{on}	$\frac{\frac{t_{on}}{t_{off}}}{f \left(\frac{t_{on}}{t_{off}} + 1 \right)}$	$\frac{\frac{t_{on}}{t_{off}}}{f \left(\frac{t_{on}}{t_{off}} + 1 \right)}$	$\frac{\frac{t_{on}}{t_{off}}}{f \left(\frac{t_{on}}{t_{off}} + 1 \right)}$
C_T	$\frac{32.143 \cdot 10^{-6}}{f} - 20 \cdot 10^{-12}$	$\frac{32.143 \cdot 10^{-6}}{f} - 20 \cdot 10^{-12}$	$\frac{32.143 \cdot 10^{-6}}{f} - 20 \cdot 10^{-12}$
$I_{L(av)}$	I_{out}	$I_{out} \left(\frac{t_{on}}{t_{off}} + 1 \right)$	$I_{out} \left(\frac{t_{on}}{t_{off}} + 1 \right)$
$I_{pk} \text{ (Switch)}$	$I_{L(av)} + \frac{\Delta I_L}{2}$	$I_{L(av)} + \frac{\Delta I_L}{2}$	$I_{L(av)} + \frac{\Delta I_L}{2}$
R_{SC}	$\frac{0.25}{I_{pk} \text{ (Switch)}}$	$\frac{0.25}{I_{pk} \text{ (Switch)}}$	$\frac{0.25}{I_{pk} \text{ (Switch)}}$
L	$\left(\frac{V_{in} - V_{sat} - V_{out}}{\Delta I_L} \right) t_{on}$	$\left(\frac{V_{in} - V_{sat}}{\Delta I_L} \right) t_{on}$	$\left(\frac{V_{in} - V_{sat}}{\Delta I_L} \right) t_{on}$
$V_{ripple(pp)}$	$\Delta I_L \sqrt{\left(\frac{1}{8 f C_O} \right)^2 + (ESR)^2}$	$\approx \frac{t_{on} I_{out}}{C_O}$	$\approx \frac{t_{on} I_{out}}{C_O}$
V_{out}	$V_{ref} \left(\frac{R_2}{R_1} + 1 \right)$	$V_{ref} \left(\frac{R_2}{R_1} + 1 \right)$	$V_{ref} \left(\frac{R_2}{R_1} + 1 \right)$

The following Converter Characteristics must be chosen:

- V_{in} – Nominal operating input voltage.
- V_{out} – Desired output voltage.
- I_{out} – Desired output current.
- ΔI_L – Desired peak-to-peak inductor ripple current. For maximum output current it is suggested that ΔI_L be chosen to be less than 10% of the average inductor current $I_{L(av)}$. This will help prevent $I_{pk} \text{ (Switch)}$ from reaching the current limit threshold set by R_{SC} . If the design goal is to use a minimum inductance value, let $\Delta I_L = 2(I_{L(av)})$. This will proportionally reduce converter output current capability.
- f – Maximum output switch frequency.
- $V_{ripple(pp)}$ – Desired peak-to-peak output ripple voltage. For best performance the ripple voltage should be kept to a low value since it will directly affect line and load regulation. Capacitor C_O should be a low equivalent series resistance (ESR) electrolytic designed for switching regulator applications.

- NOTES:**
1. V_{sat} – Saturation voltage of the output switch, refer to Figures 10 and 11.
 2. V_F – Output rectifier forward voltage drop. Typical value for 1N5822 Schottky barrier rectifier is 0.5 V.
 3. The calculated t_{on}/t_{off} must not exceed the minimum guaranteed oscillator charge to discharge ratio of 8, at the minimum operating input voltage.

Figure 22. Design Equations

NCP3163, NCV3163

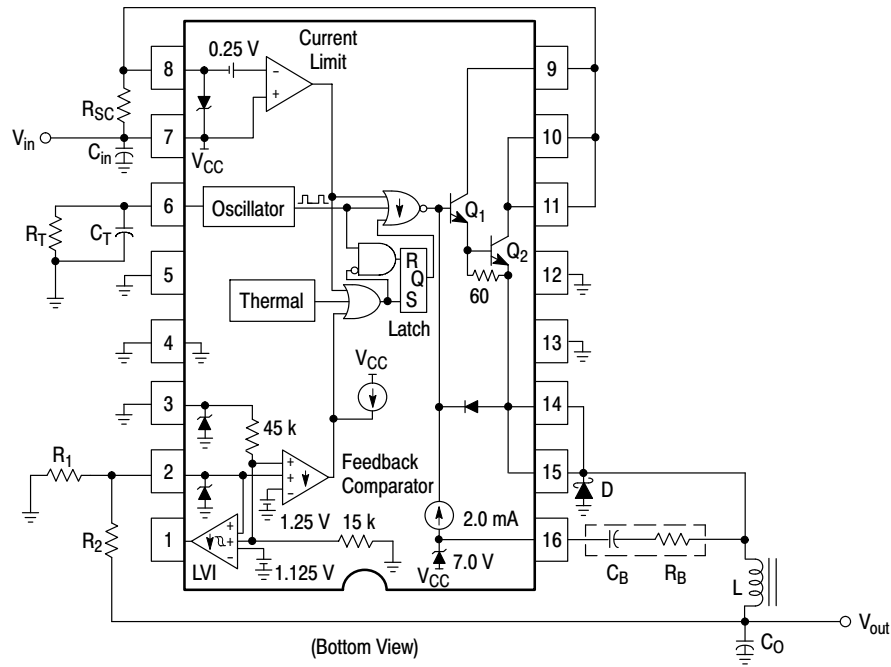

Figure 23. Typical Buck Application Schematic

Value of Components

Name	Value
L	47 μ H
D	2 A, 40 V Schottky Rectifier
C _{in}	47 μ F, 35 V
C _{out}	100 μ F, 10 V
C _t	270 pF \pm 10%
R _t	15 k Ω

Name	Value
R ₁	15 k Ω
R ₂	24.9 k Ω
R _{sc}	80 m Ω , 1 W
C _b	4.7 nF
R _b	200 Ω

Test Results for V_{out} = 3.3 V

Test	Condition	Results
Line Regulation	V _{in} = 8.0 V to 24 V, I _{out} = 2.5 A	13 mV
Load Regulation	V _{in} = 12 V, I _{out} = 0 to 2.5 A	25 mV
Output Ripple	V _{in} = 12 V, I _{out} = 0 to 2.5 A	100 mVpp
Efficiency	V _{in} = 12 V, I _{out} = 2.5 A	70.3%
Short Circuit Current	V _{in} = 12 V, R _L = 0.1 Ω	3.1 A

Test Results for V_{out} = 5.05 V

Test	Condition	Results
Line Regulation	V _{in} = 10.2 V to 24 V, I _{out} = 2.5 A	54 mV
Load Regulation	V _{in} = 12 V, I _{out} = 0 to 2.5 A	28 mV
Output Ripple	V _{in} = 12 V, I _{out} = 0 to 2.5 A	150 mVpp
Efficiency	V _{in} = 12 V, I _{out} = 2.5 A	75.5%
Short Circuit Current	V _{in} = 12 V, R _L = 0.1 Ω	3.1 A

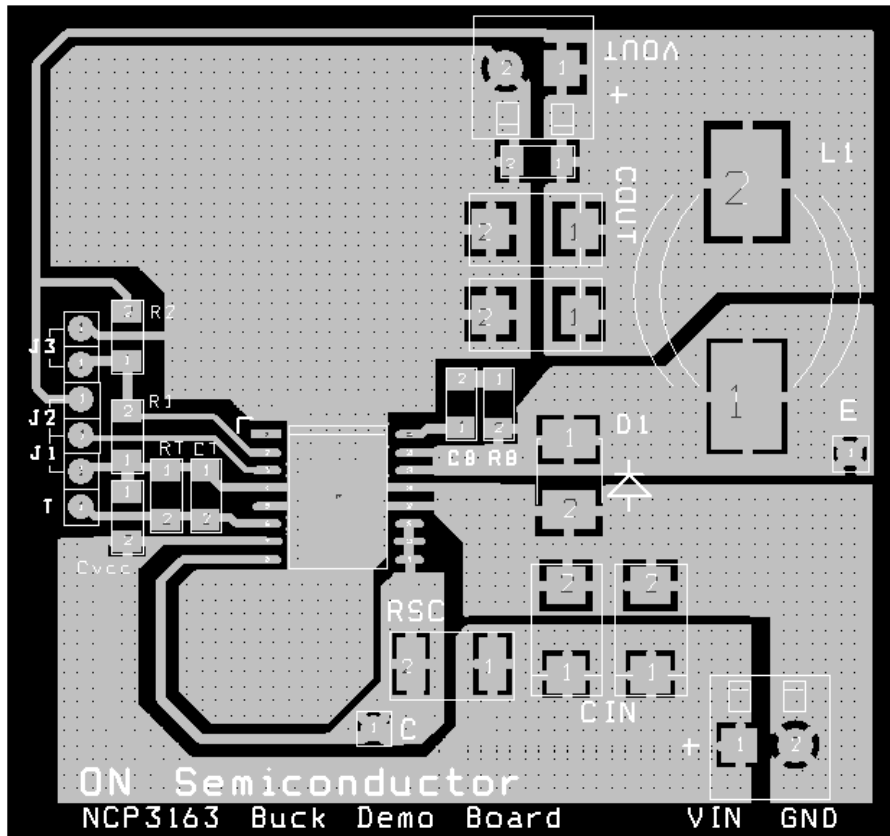

Figure 24. Buck Layout

APPLICATION SPECIFIC CHARACTERISTICS

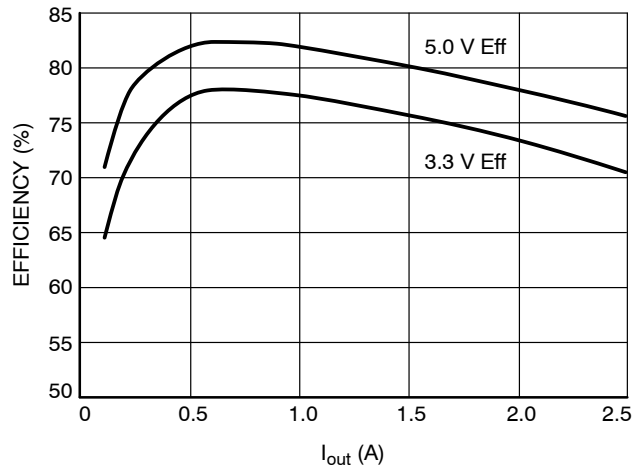

Figure 25. Efficiency vs. Output Current for the Buck Demo Board at $V_{in} = 12\text{ V}$, $T_A = 25^\circ\text{C}$

NCP3163, NCV3163

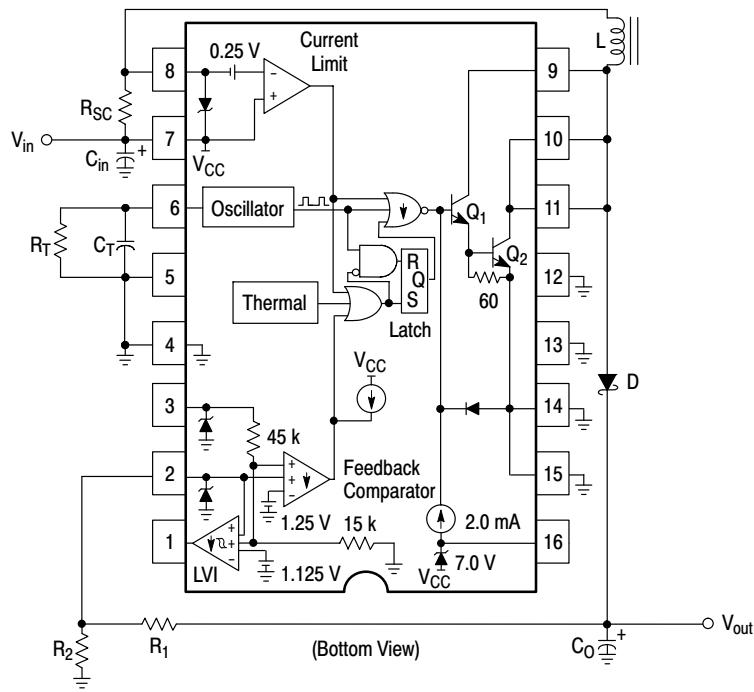

Figure 26. Typical Boost Application Schematic

Value of Components for $V_{out} = 24\text{ V}$

Name	Value
L	33 μH
D	2 A, 40 V Schottky Rectifier
C_{in}	330 μF , 35 V
C_t	270 pF $\pm 10\%$
R_t	15 k Ω

Name	Value
R_1	42.2 k Ω
R_2	2.32 k Ω
C_{out}	330 μF , 25 V
R_{sc}	80 m Ω , 1 W

Test Results for $V_{out} = 24\text{ V}$

Test	Condition	Results
Line Regulation	$V_{in} = 10\text{ V to } 20\text{ V}$, $I_{out} = 700\text{ mA}$	90 mV
Load Regulation	$V_{in} = 12\text{ V}$, $I_{out} = 0\text{ to } 700\text{ mA}$	80 mV
Output Ripple	$V_{in} = 12\text{ V}$, $I_{out} = 0\text{ to } 700\text{ mA}$	300 mV _{pp}
Efficiency	$V_{in} = 12\text{ V}$, $I_{out} = 700\text{ mA}$	83%
Short Circuit Current	$V_{in} = 12\text{ V}$, $R_L = 0.1\ \Omega$	3.1 A

NCP3163, NCV3163

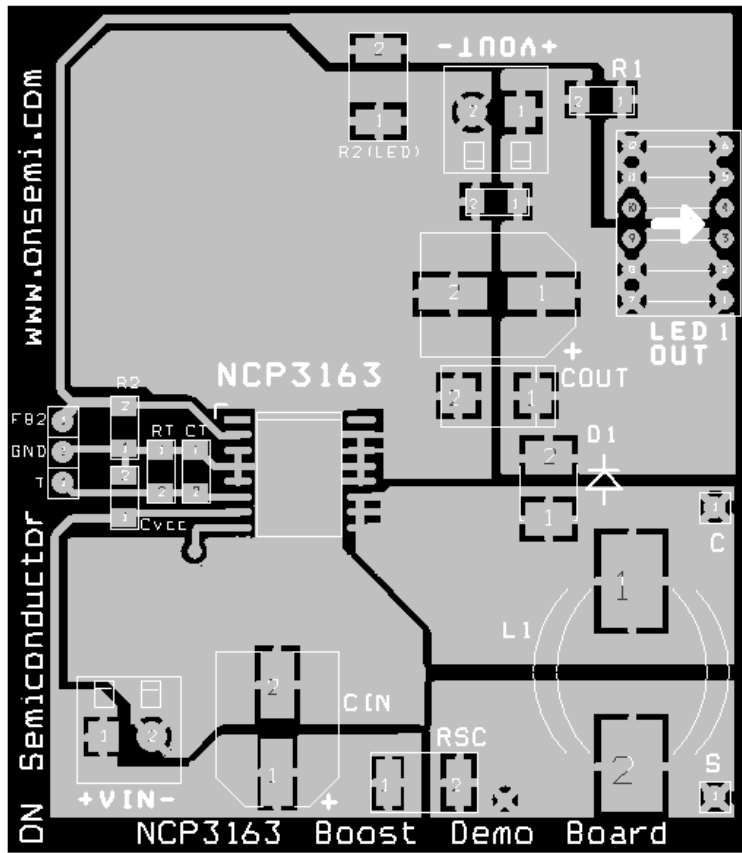

Figure 27. Boost Demo Board Layout

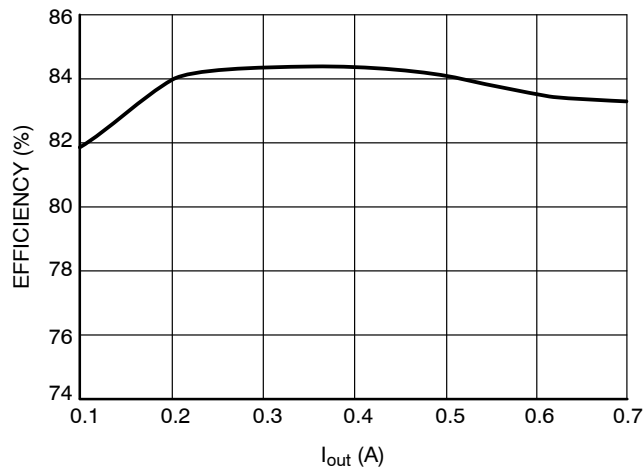

Figure 28. Efficiency vs. Output Current for the Boost Demo Board at $V_{in} = 12\text{ V}$, $T_A = 25^\circ\text{C}$

NCP3163, NCV3163

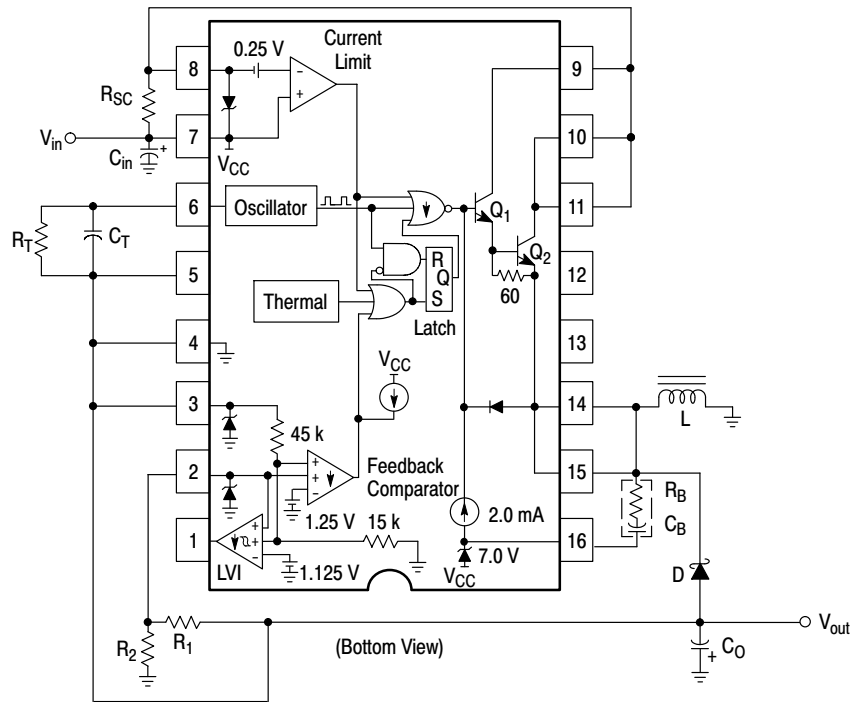

Figure 29. Typical Voltage Inverting Application Schematic

Value of Components for $V_{out} = -15\text{ V}$

Name	Value
L	47 μH
D	2 A, 40 V Schottky Rectifier
C_{in}	270 μF , 16 V
C_{out}	2 X 270 μF , 16 V
C_t	150 pF $\pm 10\%$

Name	Value
R_1	1.07 k Ω
R_2	11.8 k Ω
R_{sc}	80 m Ω , 1 W
C_b	4.7 nF
R_b	200 Ω

Test Results for $V_{out} = -15\text{ V}$

Test	Condition	Results
Line Regulation	$V_{in} = 7.0\text{ V to }16\text{ V}$, $I_{out} = 500\text{ mA}$	35 mV
Load Regulation	$V_{in} = 12\text{ V}$, $I_{out} = 0\text{ to }500\text{ mA}$	20 mV
Output Ripple	$V_{in} = 12\text{ V}$, $I_{out} = 0\text{ to }500\text{ mA}$	100 mVpp
Efficiency	$V_{in} = 12\text{ V}$, $I_{out} = 500\text{ mA}$	68%
Short Circuit Current	$V_{in} = 12\text{ V}$, $R_L = 0.1\ \Omega$	3.1 A

NCP3163, NCV3163

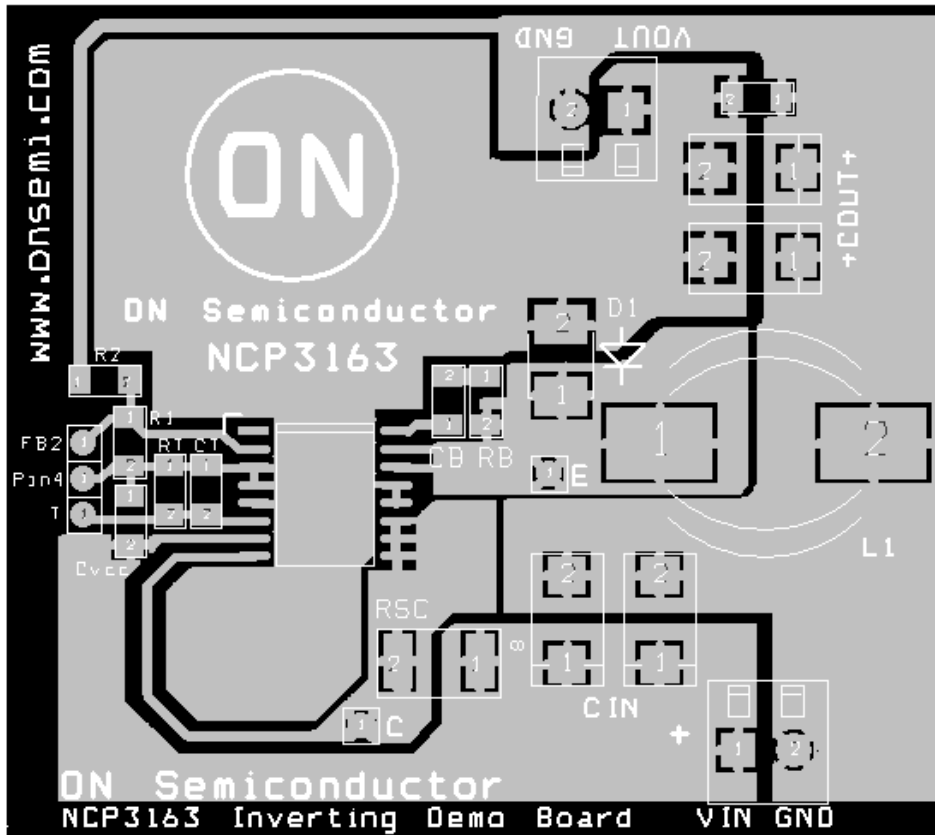

Figure 30. Voltage Inverting Demo Board Layout

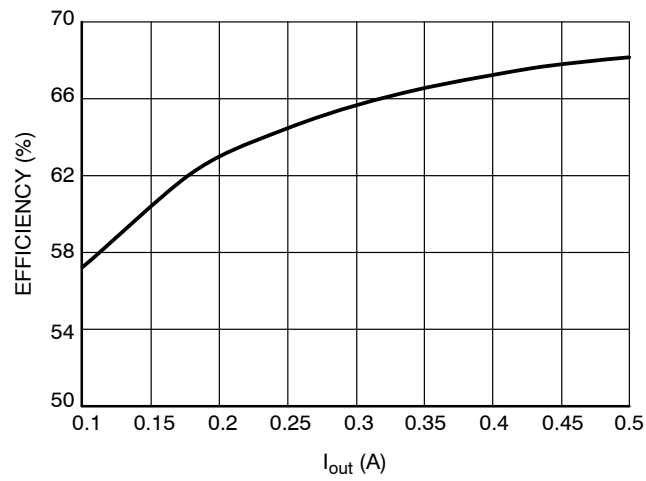

Figure 31. Efficiency vs. Output Current for the Voltage Inverting Demo Board at $V_{in} = 12\text{ V}$, $T_A = 25^\circ\text{C}$

NCP3163, NCV3163

ORDERING INFORMATION

Device	Package	Shipping†
NCP3163PWG	SOIC-16 W Exposed Pad (Pb-Free)	47 Units / Rail
NCP3163PWR2G	SOIC-16 W Exposed Pad (Pb-Free)	1000 / Tape & Reel
NCP3163BPWG	SOIC-16 W Exposed Pad (Pb-Free)	47 Units / Rail
NCP3163BPWR2G	SOIC-16 W Exposed Pad (Pb-Free)	1000 / Tape & Reel
NCP3163MNR2G	DFN18 (Pb-Free)	2500 / Tape & Reel
NCP3163BMNR2G	DFN18 (Pb-Free)	2500 / Tape & Reel
NCV3163PWG	SOIC-16 W Exposed Pad (Pb-Free)	47 Units / Rail
NCV3163PWR2G	SOIC-16 W Exposed Pad (Pb-Free)	1000 / Tape & Reel
NCV3163MNR2G	DFN18 (Pb-Free)	2500 / Tape & Reel

†For information on tape and reel specifications, including part orientation and tape sizes, please refer to our Tape and Reel Packaging Specifications Brochure, BRD8011/D.

MECHANICAL CASE OUTLINE

PACKAGE DIMENSIONS

ON Semiconductor®



DFN18 6x5, 0.5P
CASE 505-01
ISSUE D

DATE 17 NOV 2006

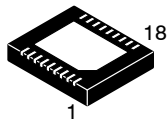

SCALE 2:1

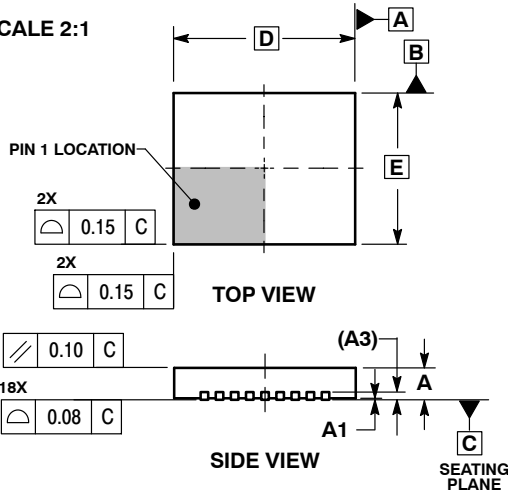

2X

	0.15	C
--	------	---

2X

	0.15	C
--	------	---

	0.10	C
	0.08	C

NOTES:

1. DIMENSIONS AND TOLERANCING PER ASME Y14.5M, 1994.
2. DIMENSIONS IN MILLIMETERS.
3. DIMENSION b APPLIES TO PLATED TERMINAL AND IS MEASURED BETWEEN 0.25 AND 0.30 MM FROM TERMINAL
4. COPLANARITY APPLIES TO THE EXPOSED PAD AS WELL AS THE TERMINALS.

DIM	MILLIMETERS	
	MIN	MAX
A	0.80	1.00
A1	0.00	0.05
A3	0.20 REF	
b	0.18	0.30
D	6.00 BSC	
D2	3.98	4.28
E	5.00 BSC	
E2	2.98	3.28
e	0.50 BSC	
K	0.20	---
L	0.45	0.65

GENERIC MARKING DIAGRAM*

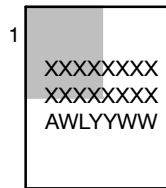

- XXXXX = Specific Device Code
- A = Assembly Location
- WL = Wafer Lot
- YY = Year
- WW = Work Week
- = Pb-Free Package

*This information is generic. Please refer to device data sheet for actual part marking. Pb-Free indicator, "G" or microdot "▪", may or may not be present.

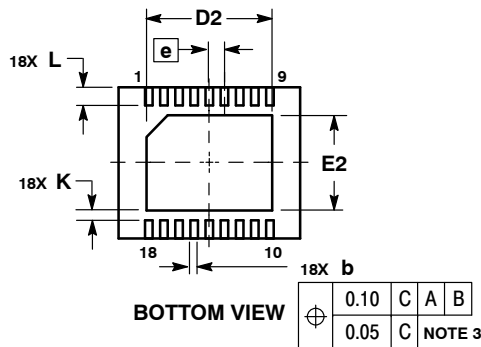

	0.10	C	A	B
	0.05	C	NOTE 3	

SOLDERING FOOTPRINT

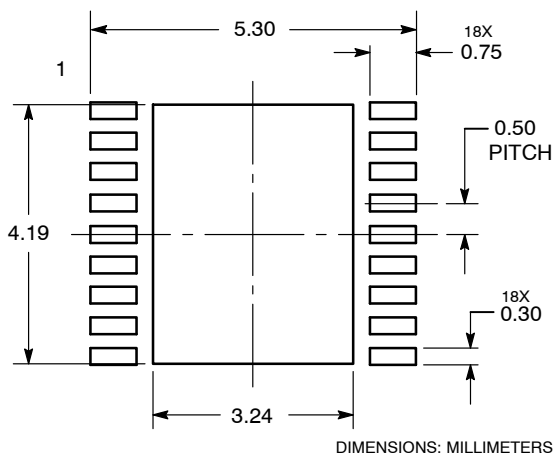

DIMENSIONS: MILLIMETERS

DOCUMENT NUMBER:	98AON11920D	Electronic versions are uncontrolled except when accessed directly from the Document Repository. Printed versions are uncontrolled except when stamped "CONTROLLED COPY" in red.
DESCRIPTION:	18 PIN DFN, 6X5 MM. 0.5 MM PITCH	PAGE 1 OF 1

ON Semiconductor and are trademarks of Semiconductor Components Industries, LLC dba ON Semiconductor or its subsidiaries in the United States and/or other countries. ON Semiconductor reserves the right to make changes without further notice to any products herein. ON Semiconductor makes no warranty, representation or guarantee regarding the suitability of its products for any particular purpose, nor does ON Semiconductor assume any liability arising out of the application or use of any product or circuit, and specifically disclaims any and all liability, including without limitation special, consequential or incidental damages. ON Semiconductor does not convey any license under its patent rights nor the rights of others.

MECHANICAL CASE OUTLINE

PACKAGE DIMENSIONS

ON Semiconductor®

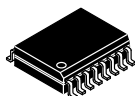

SOIC 16 LEAD WIDE BODY, EXPOSED PAD CASE 751AG ISSUE B

DATE 31 MAY 2016

SCALE 1:1

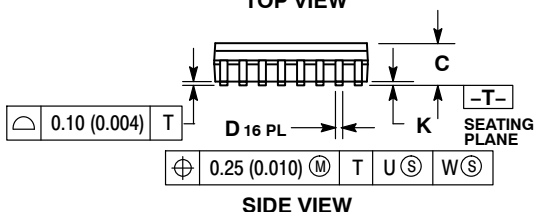

SOLDERING FOOTPRINT*



DIMENSIONS: INCHES

*For additional information on our Pb-Free strategy and soldering details, please download the ON Semiconductor Soldering and Mounting Techniques Reference Manual, SOLDERRM/D.

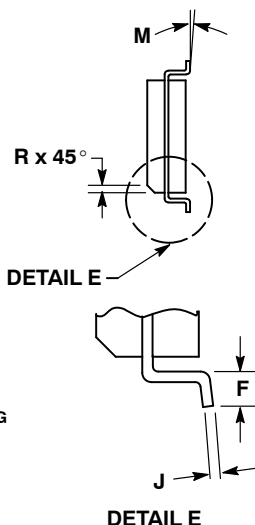

NOTES:

1. DIMENSIONING AND TOLERANCING PER ANSI Y14.5M, 1982.
2. CONTROLLING DIMENSION: MILLIMETER.
3. DIMENSION A AND B DO NOT INCLUDE MOLD PROTRUSION.
4. MAXIMUM MOLD PROTRUSION 0.15 (0.006) PER SIDE.
5. DIMENSION D DOES NOT INCLUDE DAMBAR PROTRUSION. ALLOWABLE PROTRUSION SHALL BE 0.13 (0.005) TOTAL IN EXCESS OF THE D DIMENSION AT MAXIMUM MATERIAL CONDITION.
6. 751R-01 OBSOLETE, NEW STANDARD 751R-02.

DIM	MILLIMETERS		INCHES	
	MIN	MAX	MIN	MAX
A	10.15	10.45	0.400	0.411
B	7.40	7.60	0.292	0.299
C	2.35	2.65	0.093	0.104
D	0.35	0.49	0.014	0.019
F	0.50	0.90	0.020	0.035
G	1.27 BSC		0.050 BSC	
H	3.45	3.66	0.136	0.144
J	0.25	0.32	0.010	0.012
K	0.00	0.10	0.000	0.004
L	4.72	4.93	0.186	0.194
M	0°	7°	0°	7°
P	10.05	10.55	0.395	0.415
R	0.25	0.75	0.010	0.029

GENERIC MARKING DIAGRAM*

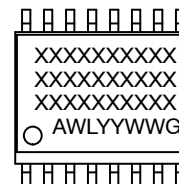

- XXXXXX = Specific Device Code
- A = Assembly Location
- WL = Wafer Lot
- YY = Year
- WW = Work Week
- G = Pb-Free Package

*This information is generic. Please refer to device data sheet for actual part marking. Pb-Free indicator, "G" or microdot "▪", may or may not be present.

DOCUMENT NUMBER:	98AON21237D	Electronic versions are uncontrolled except when accessed directly from the Document Repository. Printed versions are uncontrolled except when stamped "CONTROLLED COPY" in red.
DESCRIPTION:	SOIC-16, WB EXPOSED PAD	PAGE 1 OF 1

ON Semiconductor and ON are trademarks of Semiconductor Components Industries, LLC dba ON Semiconductor or its subsidiaries in the United States and/or other countries. ON Semiconductor reserves the right to make changes without further notice to any products herein. ON Semiconductor makes no warranty, representation or guarantee regarding the suitability of its products for any particular purpose, nor does ON Semiconductor assume any liability arising out of the application or use of any product or circuit, and specifically disclaims any and all liability, including without limitation special, consequential or incidental damages. ON Semiconductor does not convey any license under its patent rights nor the rights of others.

ON Semiconductor and  are trademarks of Semiconductor Components Industries, LLC dba ON Semiconductor or its subsidiaries in the United States and/or other countries. ON Semiconductor owns the rights to a number of patents, trademarks, copyrights, trade secrets, and other intellectual property. A listing of ON Semiconductor's product/patent coverage may be accessed at www.onsemi.com/site/pdf/Patent-Marking.pdf. ON Semiconductor reserves the right to make changes without further notice to any products herein. ON Semiconductor makes no warranty, representation or guarantee regarding the suitability of its products for any particular purpose, nor does ON Semiconductor assume any liability arising out of the application or use of any product or circuit, and specifically disclaims any and all liability, including without limitation special, consequential or incidental damages. Buyer is responsible for its products and applications using ON Semiconductor products, including compliance with all laws, regulations and safety requirements or standards, regardless of any support or applications information provided by ON Semiconductor. "Typical" parameters which may be provided in ON Semiconductor data sheets and/or specifications can and do vary in different applications and actual performance may vary over time. All operating parameters, including "Typicals" must be validated for each customer application by customer's technical experts. ON Semiconductor does not convey any license under its patent rights nor the rights of others. ON Semiconductor products are not designed, intended, or authorized for use as a critical component in life support systems or any FDA Class 3 medical devices or medical devices with a same or similar classification in a foreign jurisdiction or any devices intended for implantation in the human body. Should Buyer purchase or use ON Semiconductor products for any such unintended or unauthorized application, Buyer shall indemnify and hold ON Semiconductor and its officers, employees, subsidiaries, affiliates, and distributors harmless against all claims, costs, damages, and expenses, and reasonable attorney fees arising out of, directly or indirectly, any claim of personal injury or death associated with such unintended or unauthorized use, even if such claim alleges that ON Semiconductor was negligent regarding the design or manufacture of the part. ON Semiconductor is an Equal Opportunity/Affirmative Action Employer. This literature is subject to all applicable copyright laws and is not for resale in any manner.

PUBLICATION ORDERING INFORMATION

LITERATURE FULFILLMENT:

Email Requests to: orderlit@onsemi.com

ON Semiconductor Website: www.onsemi.com

TECHNICAL SUPPORT

North American Technical Support:
Voice Mail: 1 800-282-9855 Toll Free USA/Canada
Phone: 011 421 33 790 2910

Europe, Middle East and Africa Technical Support:

Phone: 00421 33 790 2910

For additional information, please contact your local Sales Representative