

# NPN Silicon Phototransistor

OP550, OP552, OP555, OP560, OP565, OP750 Series



## Features:

- Wide receiving angle
- Four sensitivity ranges
- Side-looking package
- Ideal for space-limited applications
- Ideal for PCBoard mounting
- Choice of clear, opaque or blue-tinted package

## Description:

**OP550, OP552, OP555, OP750, and OP770** series consists of a NPN silicon phototransistor molded in an epoxy package with a wide receiving angle that provides relatively even reception over a large area. The **OP750** and **OP770** have additional circuitry to enhance the operation of the device for stray light levels.

**OP560** and **OP565** series consists of a NPN silicon photodarlington transistor molded in an epoxy package with a wide receiving angle that provides relatively even reception over a large area.

The side-looking package design allows easy PCBoard mounting of slotted optical switches or optical interrupt detectors.

The **OP550, OP560, OP750** and **OP770** devices have an external lens in a clear epoxy package.

The **OP552** device has an integral lens in an opaque plastic package that is optically transparent to infrared light but opaque to visible wavelengths. This feature allows the device to be used under high ambient light conditions – or anywhere external light sources could interfere with the intended sensing application (visible light immunity).

The **OP555** and **OP565** devices have an internal lens in a blue-tinted package. The lensing effect of this package allows an acceptance half-angle of 28° when measured from the optical axis to the half-power point.

*These devices are 100% production tested using infrared light for close correlation with OPTEK's GaAs and GaAlAs emitters. All of these sensors are mechanically and spectrally matched to the **OP140, OP142, OP145, OP240** and **OP245** series of infrared emitting diodes.*

Please refer to Application Bulletins 208 and 210 for additional design information and reliability (degradation) data.

For custom versions please contact your OPTEK representative.

## Applications:

- Applications requiring wide receiving angle
- Applications requiring PCBoard mounting
- Space-limited applications
- Optical switches
- Optical interrupt detectors
- Optical encoders
- Non-contact position sensing
- Machine automation

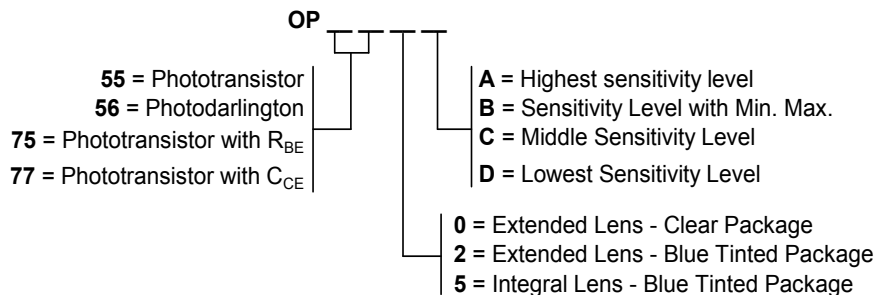

Available Part Numbers							
OP550A		OP555A	OP560A		OP750A		OP770A
OP550B		OP555B		OP565B	OP750B		
OP550C		OP555C	OP560C				
OP550D	OP552D				OP750D		



RoHS

### General Note

TT Electronics reserves the right to make changes in product specification without notice or liability. All information is subject to TT Electronics' own data and is considered accurate at time of going to print.

OPTEK Technology, Inc.  
1645 Wallace Drive, Carrollton, TX 75006 | Ph: +1 972 323 2200  
www.optekinc.com | www.ttelectronics.com

# NPN Silicon Phototransistor

OP550, OP552, OP555, OP560, OP565,  
OP750 Series



OP550, OP552, OP560, OP750, OP770 (A, B, C, D)

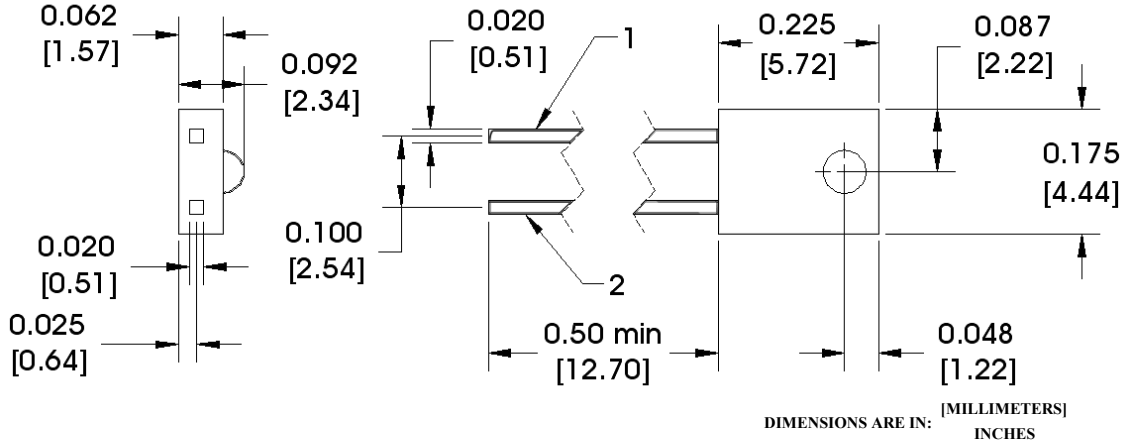

OP555, OP565 (A, B, C, D)

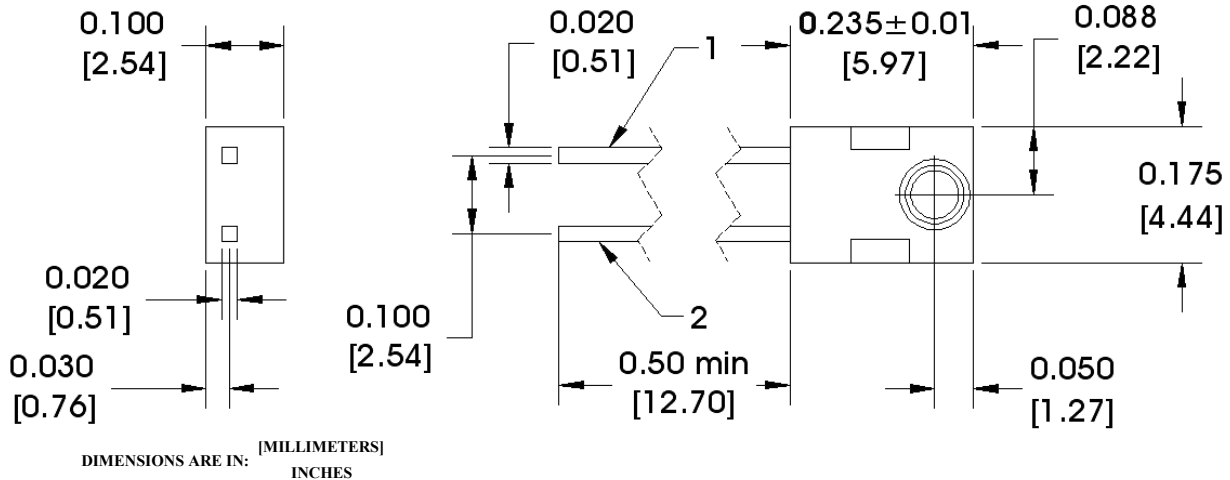

Pin #	Sensor
1	Emitter
2	Collector

**OP555 - CONTAINS POLYSULFONE**  
To avoid stress cracking, we suggest using ND Industries' **Vibra-Tite** for thread-locking. **Vibra-Tite** evaporates fast without causing structural failure in OPTEK'S molded plastics.

**Notes:**

1. RMA flux is recommended. Duration can be extended to 10 seconds maximum when flow soldering. A maximum 20 grams force may be applied to the leads when soldering.
2. For OP550, OP560, OP555 and OP565, derate linearly 1.33 mW/° C above 25° C. For OP552, derate linearly 1.25 mW/° C above 25° C.
3. For all phototransistors in this series, the light source is an unfiltered GaAs LED with a peak emission wavelength of 935 nm. For OP550 and OP555 only, a radiometric intensity level that varies less than 10% over the entire lens surface of the phototransistor being tested applies.
4. To calculate typical collector dark current in  $\mu\text{A}$ , use the formula  $I_{CE0} = 10^{(0.040 T_A - 3.4)}$ , where  $T_A$  is ambient temperature in °C.

**General Note**

TT Electronics reserves the right to make changes in product specification without notice or liability. All information is subject to TT Electronics' own data and is considered accurate at time of going to print.

OPTEK Technology, Inc.  
1645 Wallace Drive, Carrollton, TX 75006 | Ph: +1 972 323 2200  
www.optekinc.com | www.ttelectronics.com

# NPN Silicon Phototransistor

OP550, OP552, OP555, OP560, OP565,  
OP750 Series



## Electrical Specifications

Absolute Maximum Ratings ( $T_A = 25^\circ\text{C}$ unless otherwise noted)	
Storage Temperature Range	$-40^\circ\text{C}$ to $+100^\circ\text{C}$
Operating Temperature Range OP550, OP555, OP560, OP565, OP750 OP552	$-40^\circ\text{C}$ to $+100^\circ\text{C}$ $-40^\circ\text{C}$ to $+85^\circ\text{C}$
Collector-Emitter Voltage OP550, OP552, OP555, OP560, OP750 OP565	30 V 15 V
Emitter-Collector Voltage	5 V
Lead Soldering Temperature [1/16 inch (1.6 mm) from case for 5 seconds with soldering iron]	$260^\circ\text{C}^{(1)}$
Power Dissipation OP550, OP552, OP555, OP560, OP565 OP750	100 mW <sup>(2)</sup> 200 mW <sup>(2)</sup>

### General Note

TT Electronics reserves the right to make changes in product specification without notice or liability. All information is subject to TT Electronics' own data and is considered accurate at time of going to print.

OPTEK Technology, Inc.  
1645 Wallace Drive, Carrollton, TX 75006 | Ph: +1 972 323 2200  
www.optekinc.com | www.ttelectronics.com

# NPN Silicon Phototransistor

OP550, OP552, OP555, OP560, OP565,  
OP750 Series



## Electrical Specifications

Electrical Characteristics (T <sub>A</sub> = 25° C unless otherwise noted)						
SYMBOL	PARAMETER	MIN	TYP	MAX	UNITS	TEST CONDITIONS
I <sub>C(ON)</sub>	On-State Collector Current					
	OP550A, OP555A	2.55	-	-	mA	V <sub>CE</sub> = 5.0 V, E <sub>E</sub> = 1.0 mW/cm <sup>2(3)</sup>
	OP550B, OP555B	1.30	-	4.70		
	OP550C, OP555C	0.25	-	2.40		
	OP550D, OP552D	0.25	-	-		
	OP560A	6.6	-	-	mA	V <sub>CE</sub> = 2.0 V, E <sub>E</sub> = 0.1 mW/cm <sup>2(3)</sup>
	OP565B	3.3	-	9.8		
OP560C	1.1	-	-			
	OP750A	2.25	-	7.00	mA	V <sub>CE</sub> = 5.0 V, E <sub>E</sub> = 1.0 mW/cm <sup>2(3)</sup>
	OP750B	1.50	-	4.20		
	OP750D	0.85	-	7.00		
	OP770A	2.25	-	7.00		
I <sub>C</sub> /Δ T	Relative I <sub>C</sub> Charge with Temperature	-	1.00	-	%/°C	V <sub>CE</sub> = 5.0 V, E <sub>E</sub> = 1.0 mW/cm <sup>2</sup> , λ = 935 nm
I <sub>CEO</sub>	Collector-Dark Current	-	-	100	nA	V <sub>CE</sub> = 10.0 V, E <sub>E</sub> = 0 <sup>(4)</sup>
V <sub>(BR)CEO</sub>	Collector-Emitter Breakdown Voltage OP550, OP552, OP555, OP750, OP770 OP560, OP565	30	-	-	V	I <sub>C</sub> = 100 μA, E <sub>E</sub> = 0 <sup>(4)</sup>
		15	-	-		I <sub>C</sub> = 1 mA, E <sub>E</sub> = 0 <sup>(4)</sup>
V <sub>(BR)ECO</sub>	Emitter-Collector Breakdown Voltage	5.0	-	-	V	I <sub>E</sub> = 100 μA
V <sub>CE(SAT)</sub>	Collector-Emitter Saturation Voltage OP550, OP552, OP555, OP750, OP770 OP560, OP565	-	-	0.40	V	I <sub>C</sub> = 100 μA, E <sub>E</sub> = 1.0 mW/cm <sup>2(3)</sup>
		-	-	1.10		I <sub>C</sub> = 0.4 mA, E <sub>E</sub> = 0.1 mW/cm <sup>2(3)</sup>

See page 2 for Notes

### General Note

TT Electronics reserves the right to make changes in product specification without notice or liability. All information is subject to TT Electronics' own data and is considered accurate at time of going to print.

OPTEK Technology, Inc.  
1645 Wallace Drive, Carrollton, TX 75006 | Ph: +1 972 323 2200  
www.optekinc.com | www.ttelectronics.com

# NPN Silicon Phototransistor

OP550, OP552, OP555, OP560, OP565,  
OP750 Series



## Performance

Switching Test Circuit

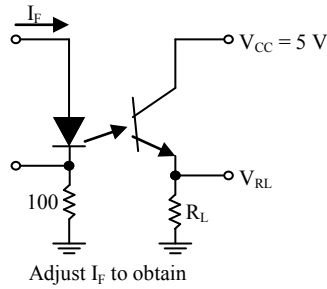

OP552 - Angular Response

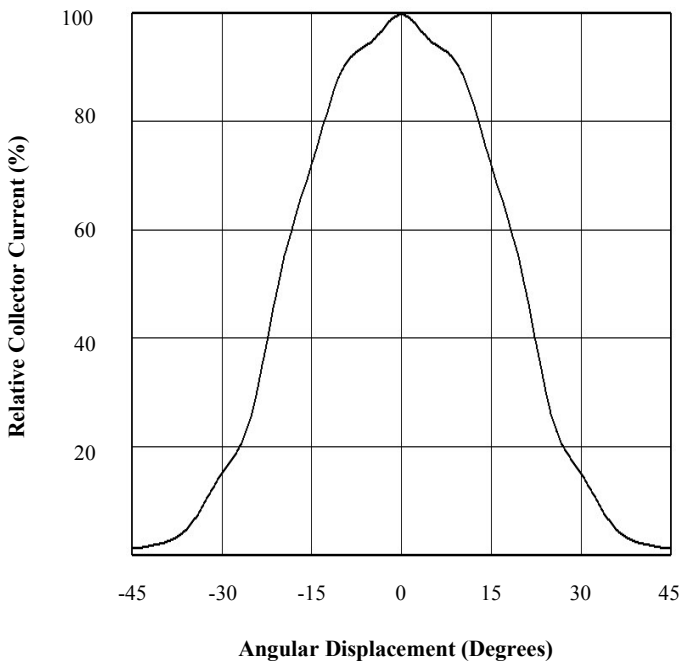

OP552 - On-State Collector Current vs Irradiance

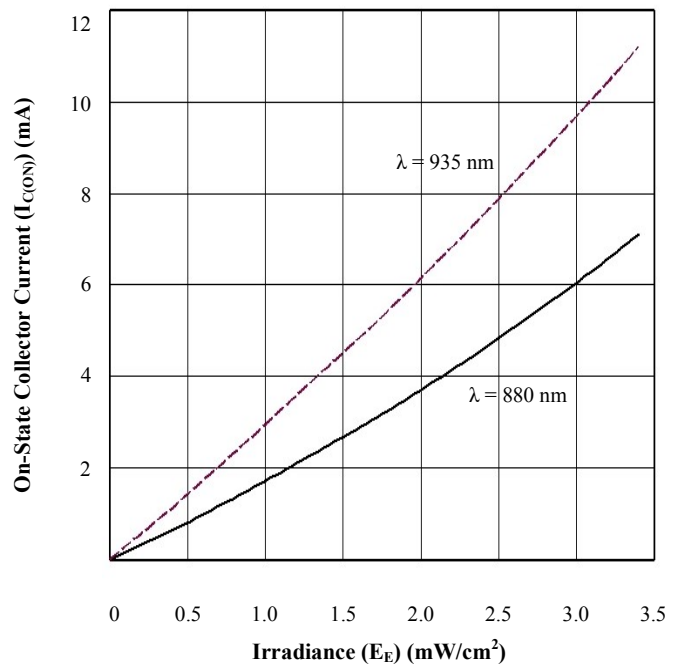

### General Note

TT Electronics reserves the right to make changes in product specification without notice or liability. All information is subject to TT Electronics' own data and is considered accurate at time of going to print.

# NPN Silicon Phototransistor

OP550, OP552, OP555, OP560, OP565,  
OP750 Series



## Performance

OP552 - Output Vs Frequency

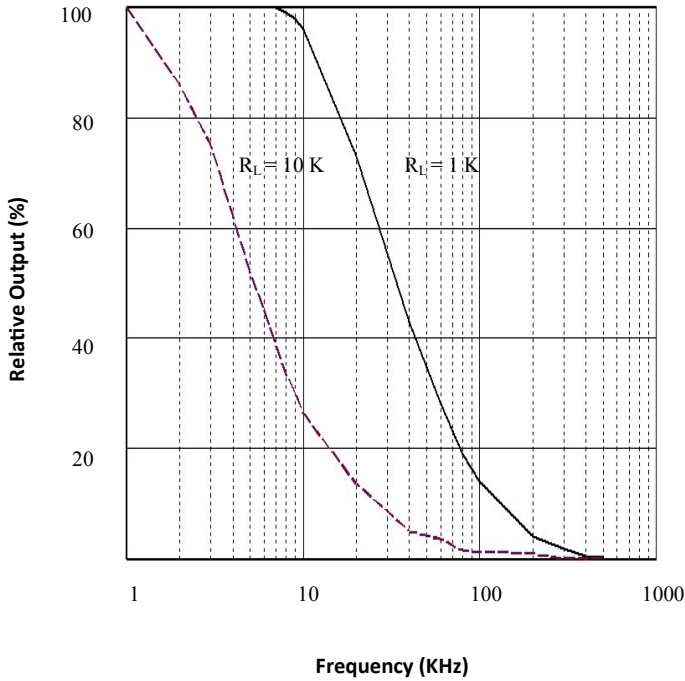

OP552 - Rise and Fall Time vs Load Resistance

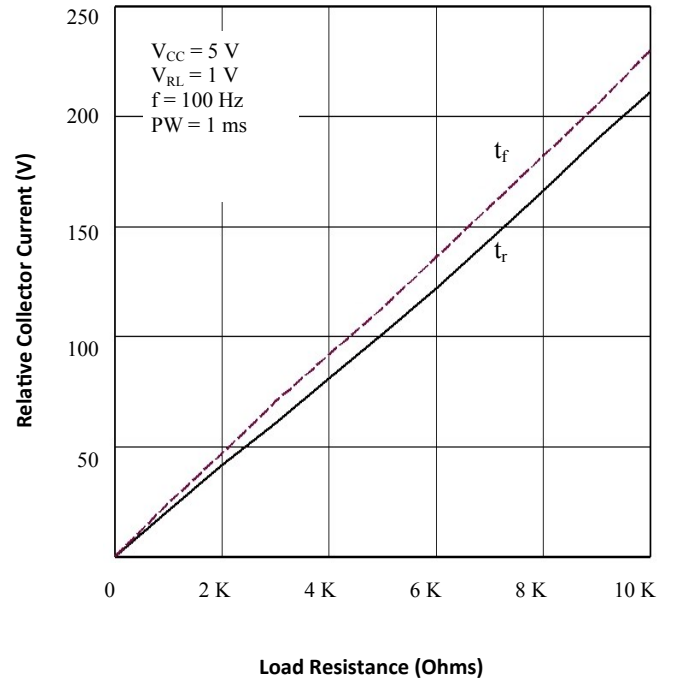

OP552 - Typical Spectral Response

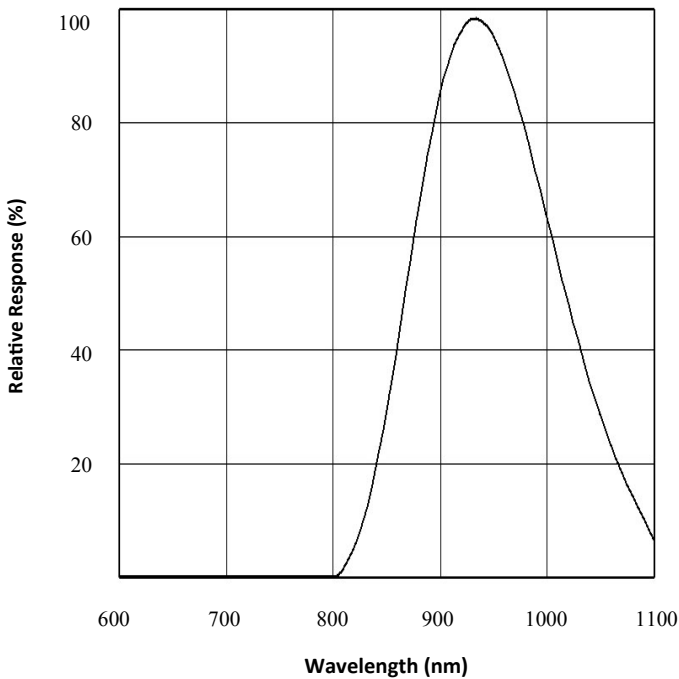

OP552 - Coupling Characteristic

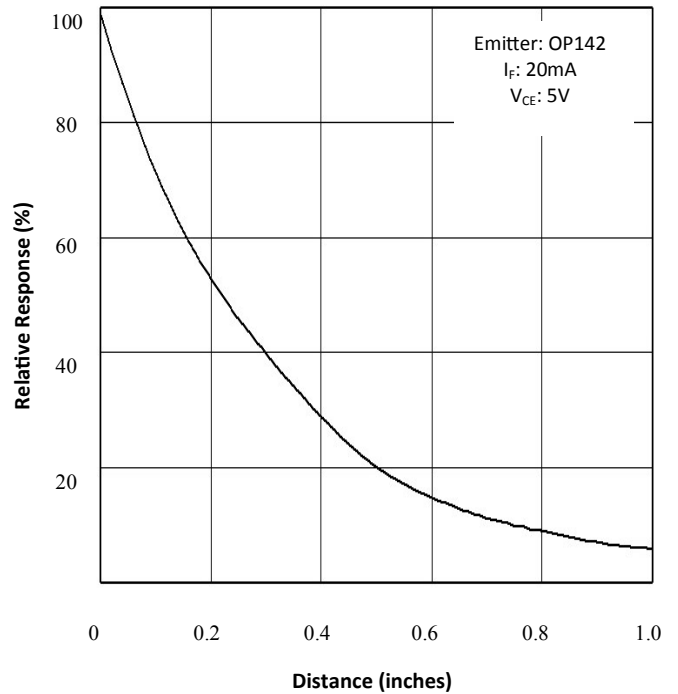

**General Note**

TT Electronics reserves the right to make changes in product specification without notice or liability. All information is subject to TT Electronics' own data and is considered accurate at time of going to print.

OPTEK Technology, Inc.  
1645 Wallace Drive, Carrollton, TX 75006 | Ph: +1 972 323 2200  
www.optekinc.com | www.ttelectronics.com

# Mouser Electronics

Authorized Distributor

Click to View Pricing, Inventory, Delivery & Lifecycle Information:

## TT Electronics:

[OP550A](#) [OP550B](#) [OP550C](#) [OP550D](#) [OP555A](#) [OP555B](#) [OP555C](#) [OP555D](#) [OP560A](#) [OP560B](#) [OP560C](#) [OP565A](#)  
[OP565B](#) [OP565C](#) [OP750A](#) [OP750B](#) [OP750C](#) [OP750D](#) [OP755A](#) [OP755B](#) [OP755C](#) [OP755D](#) [OP775A](#) [OP775B](#)  
[OP775C](#) [OP775D](#)